

West Burton Solar Project

Environmental Statement Appendix 11.4: Geo-Environmental Risk Assessment West Burton Cable Corridor (part 2 of 5)

Prepared by: Delta Simons

March 2023

PINS reference: EN010132

Document reference: APP/WB6.3.11.4

APFP Regulation 5(2)(a)



Lincolnshire

Published 1886

Source map scale - 1:2,500

The historical maps shown were reproduced from maps predominantly held at the scale adopted for England, Wales and Scotland in the 1840's. In 1854 the 1:2,500 scale was adopted for mapping urban areas and by 1896 it covered the whole of what were considered to be the cultivated parts of Great Britain. The published date given below is often some years later than the surveyed date. Before 1938, all OS maps were based on the Cassini Projection, with independent surveys of a single county or group of counties, giving rise to significant inaccuracies in outlying areas.

Map Name(s) and Date(s)

060_03
1886
1:2,500
060_07
1886
1:2,500

Historical Map - Segment C9

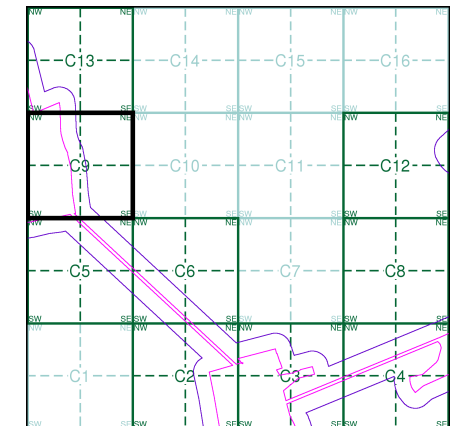

Order Details

Order Number: 298001007_1_1
 Customer Ref: 21-1098.04
 National Grid Reference: 489060, 377630
 Slice: C
 Site Area (Ha): 471.82
 Search Buffer (m): 100

Site Details

West Barton 1

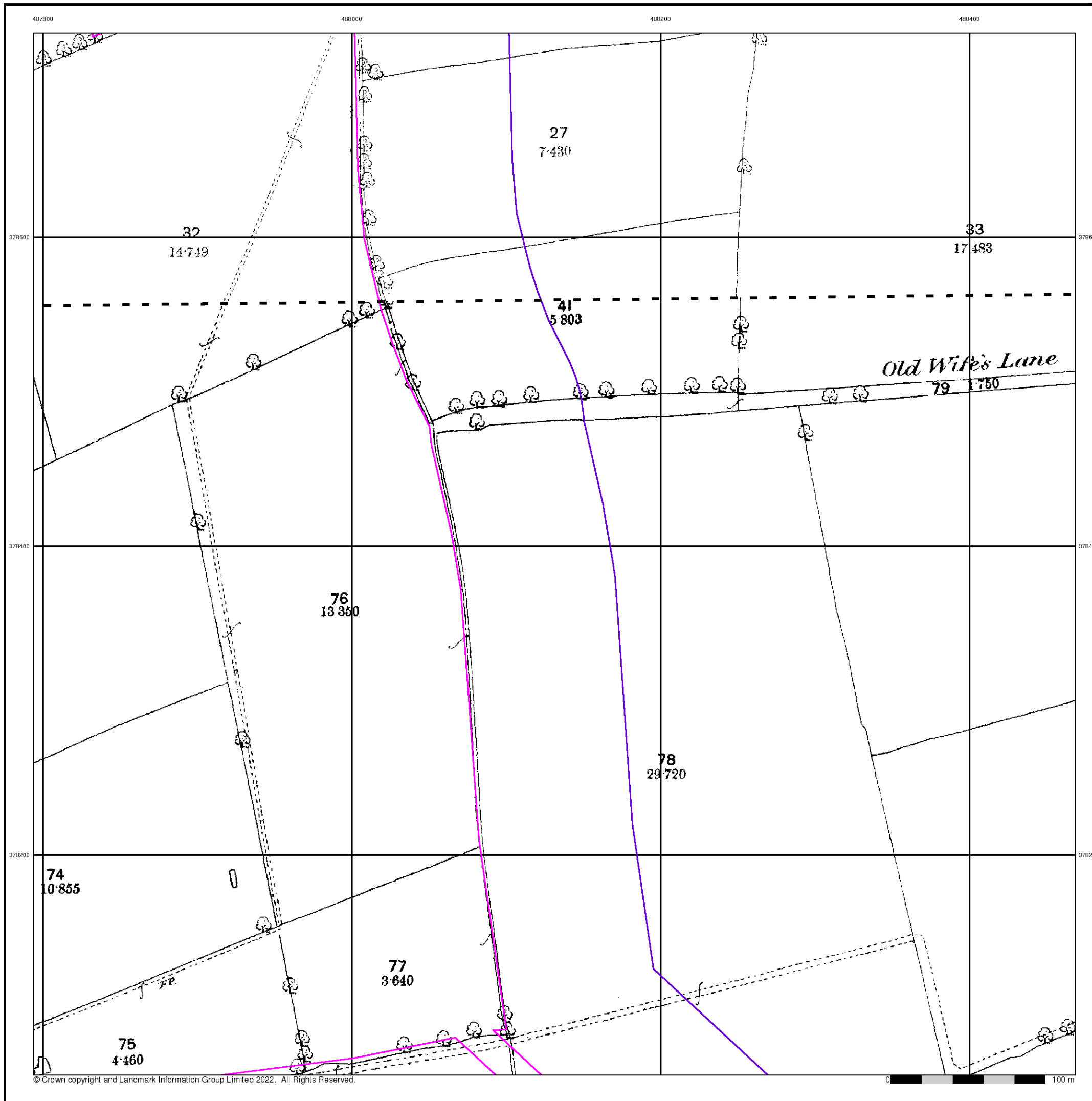

Lincolnshire

Published 1906

Source map scale - 1:2,500

The historical maps shown were reproduced from maps predominantly held at the scale adopted for England, Wales and Scotland in the 1840's. In 1854 the 1:2,500 scale was adopted for mapping urban areas and by 1896 it covered the whole of what were considered to be the cultivated parts of Great Britain. The published date given below is often some years later than the surveyed date. Before 1938, all OS maps were based on the Cassini Projection, with independent surveys of a single county or group of counties, giving rise to significant inaccuracies in outlying areas.

Map Name(s) and Date(s)

060_03
1906
1:2,500
060_07
1906
1:2,500

Historical Map - Segment C9

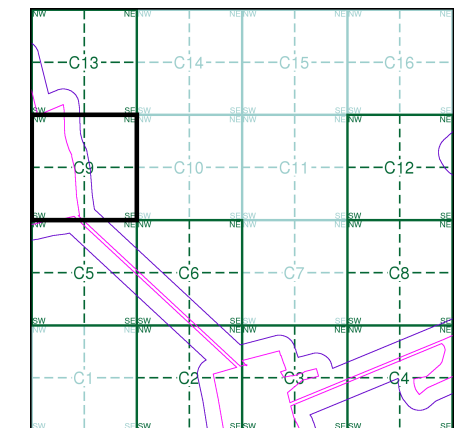

Order Details

Order Number: 298001007_1_1
 Customer Ref: 21-1098.04
 National Grid Reference: 489060, 377630
 Slice: C
 Site Area (Ha): 471.82
 Search Buffer (m): 100

Site Details

West Barton 1

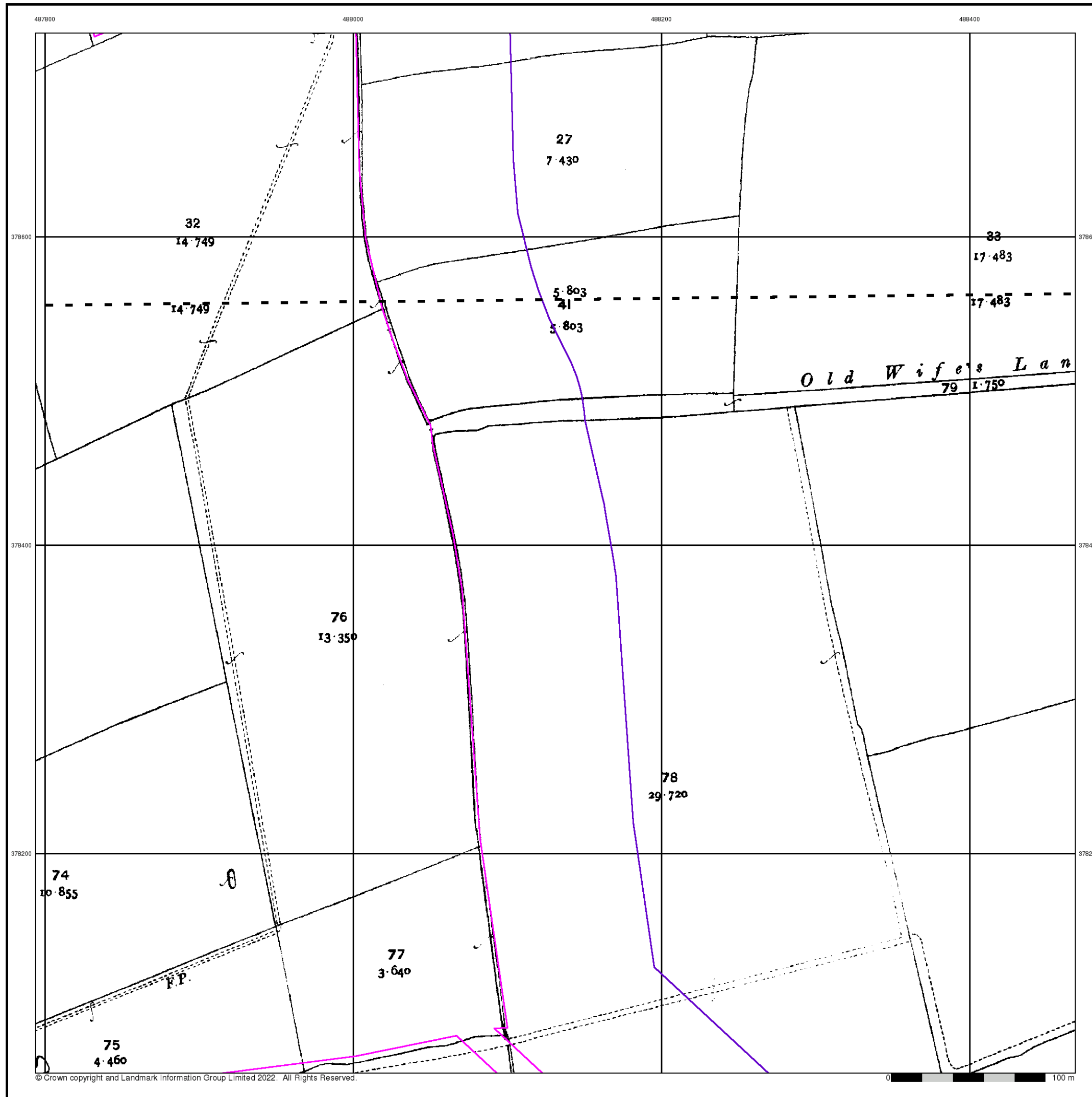

Ordnance Survey Plan

Published 1975

Source map scale - 1:2,500

The historical maps shown were reproduced from maps predominantly held at the scale adopted for England, Wales and Scotland in the 1840's. In 1854 the 1:2,500 scale was adopted for mapping urban areas and by 1896 it covered the whole of what were considered to be the cultivated parts of Great Britain. The published date given below is often some years later than the surveyed date. Before 1938, all OS maps were based on the Cassini Projection, with independent surveys of a single county or group of counties, giving rise to significant inaccuracies in outlying areas.

Map Name(s) and Date(s)

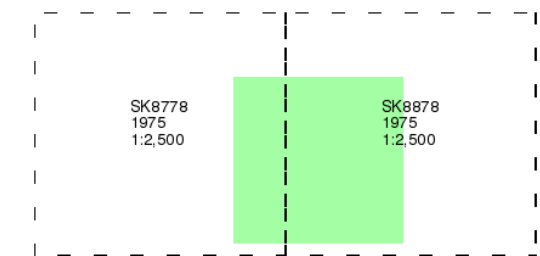

Historical Map - Segment C9

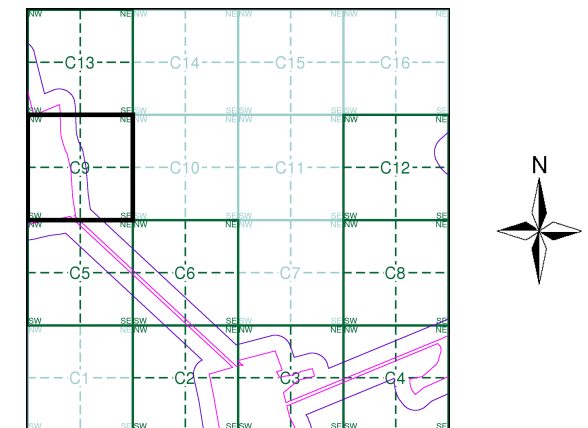

Order Details

Order Number: 298001007_1_1
 Customer Ref: 21-1098.04
 National Grid Reference: 489060, 377630
 Slice: C
 Site Area (Ha): 471.82
 Search Buffer (m): 100

Site Details

West Barton 1

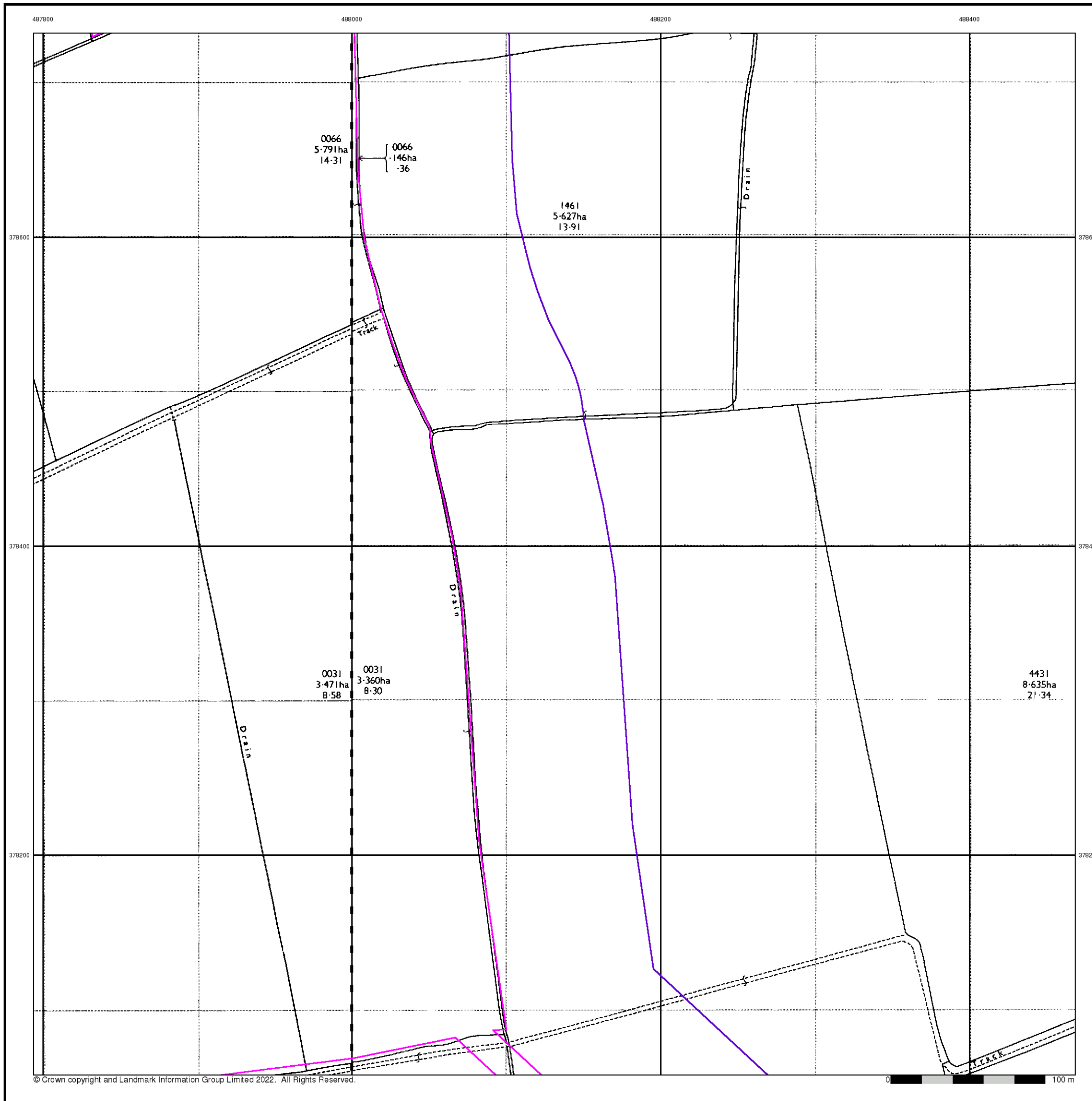

Large-Scale National Grid Data

Published 1994

Source map scale - 1:2,500

'Large Scale National Grid Data' superseded SIM cards (Ordnance Survey's 'Survey of Information on Microfilm') in 1992, and continued to be produced until 1999. These maps were the fore-runners of digital mapping and so provide detailed information on houses and roads, but tend to show less topographic features such as vegetation. These maps were produced at both 1:2,500 and 1:1,250 scales.

Map Name(s) and Date(s)

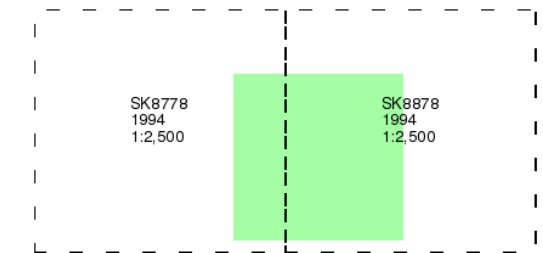

Historical Map - Segment C9

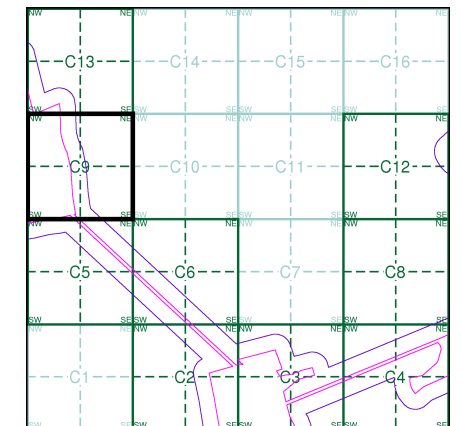

Order Details

Order Number: 298001007_1_1
 Customer Ref: 21-1098.04
 National Grid Reference: 489060, 377630
 Slice: C
 Site Area (Ha): 471.82
 Search Buffer (m): 100

Site Details

West Barton 1

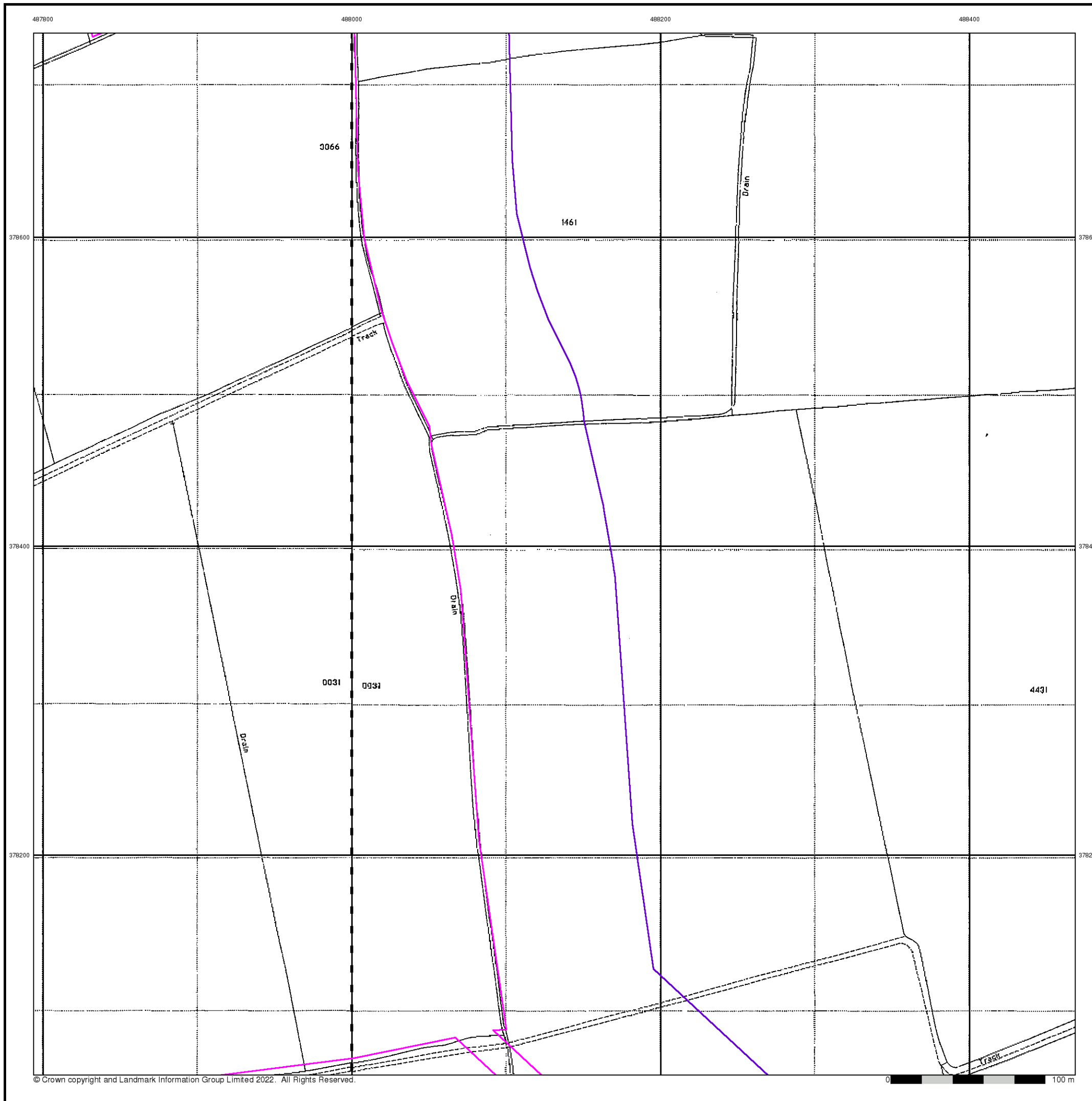

Historical Mapping Legends

Ordnance Survey County Series and Ordnance Survey Plan 1:2,500

Quarry **Gravel Pit** **Sand Pit**
Clay Pit **Shingle** **Refuse Heap**
Sloping Masonry **Flat Rock**
Marsh **Reeds** **Osiers**
Rough Pasture **Furze** **Wood**
Mixed Wood **Brushwood** **Orchard**
Fir **Ford** **Stepping Stones**
Ferry **Waterfall** **Lock**
Trig. Station **Altitude at Trig. Station**
B.M. 325.9 **Bench Mark** **Surface Level**
Arrow denotes flow of water **Antiquities (site of)**
Cutting **Embankment**
Railway crossing Road **Level Crossing** **Road crossing Railway**
Railway crossing River or Canal **Road over single stream** **Road over River or Canal**
County Boundary (Geographical)
County & Civil Parish Boundary
Administrative County & Civil Parish Boundary
County Borough Boundary (England)
County Burgh Boundary (Scotland)
Co. Boro. Bdy.
Co. Burgh Bdy.
BP BS Boundary Post or Stone **P.C.B** Police Call Box
B.R. Bridle Road **P** Pump
E.P Electricity Pylon **S.P** Signal Post
F.B. Foot Bridge **SL** Sluice
F.P. Foot Path **Sp.** Spring
G.P Guide Post or Board **T.C.B** Telephone Call Box
M.S Mile Stone **Tr.** Trough
M.P M.R Mooring Post or Ring **W** Well

Ordnance Survey Plan, Additional SIMs and Supply of Unpublished Survey Information 1:2,500 and 1:1,250

Inactive Quarry, Chalk Pit or Clay Pit **Active Quarry, Chalk Pit or Clay Pit**
Rock **Boulders**
Cliff **Slopes** **Top**
Roofed Building **Glazed Roof Building**
Sloping Masonry **Archway**
Non-Coniferous Tree (surveyed) **Coniferous Tree (surveyed)**
Non-Coniferous Trees (not surveyed) **Coniferous Trees (not surveyed)**
Orchard Tree **Scrub** **Bracken**
Coppice, Osier **Reeds** **Marsh, Saltings**
Rough Grassland **Heath** **Culvert**
Direction of water flow **Bench Mark** **Antiquity (site of)**
Cave Entrance **Triangulation Station** **Electricity Pylon**
Electricity Transmission Line
County Boundary (Geographical)
County & Civil Parish Boundary
Civil Parish Boundary
Admin. County or County Bor. Boundary
London Borough Boundary
Symbol marking point where boundary mereing changes
BH Beer House **P** Pillar, Pole or Post
BP, BS Boundary Post or Stone **PO** Post Office
Cn, C Capstan, Crane **PC** Public Convenience
Chy Chimney **PH** Public House
D Fn Drinking Fountain **Pp** Pump
EI P Electricity Pillar or Post **SB, S Br** Signal Box or Bridge
FAP Fire Alarm Pillar **SP, SL** Signal Post or Light
FB Foot Bridge **Spr** Spring
GP Guide Post **Tk** Tank or Track
H Hydrant or Hydraulic **TCB** Telephone Call Box
LC Level Crossing **TCP** Telephone Call Post
MH Manhole **Tr** Trough
MP Mile Post or Mooring Post **Wr Pt, Wr T** Water Point, Water Tap
MS Mile Stone **W** Well
NTL Normal Tidal Limit **Wd Pp** Wind Pump

Large-Scale National Grid Data 1:2,500 and 1:1,250

Cliff **Slopes** **Top**
Rock **Rock (scattered)**
Boulders **Boulders (scattered)**
Positioned Boulder **Scree**
Non-Coniferous Tree (surveyed) **Coniferous Tree (surveyed)**
Non-Coniferous Trees (not surveyed) **Coniferous Trees (not surveyed)**
Orchard Tree **Scrub** **Bracken**
Coppice, Osier **Reeds** **Marsh, Saltings**
Rough Grassland **Heath** **Culvert**
Direction of water flow **Triangulation Station** **Antiquity (site of)**
Electricity Transmission Line **Electricity Pylon**
B.M. 231.60m Bench Mark **Buildings with Building Seed**
Roofed Building **Glazed Roof Building**
Civil parish/community boundary
District boundary
County boundary
Boundary post/stone
Boundary mereing symbol (note: these always appear in opposed pairs or groups of three)
Bks Barracks **P** Pillar, Pole or Post
Bty Battery **PO** Post Office
Cemy Cemetery **PC** Public Convenience
Chy Chimney **Pp** Pump
Cis Cistern **Ppg Sta** Pumping Station
Dismtd Rly Dismantled Railway **PW** Place of Worship
EI Gen Sta Electricity Generating Station **Sewage Ppg Sta** Sewage Pumping Station
EI P Electricity Pole, Pillar **SB, S Br** Signal Box or Bridge
EI Sub Sta Electricity Sub Station **SP, SL** Signal Post or Light
FB Filter Bed **Spr** Spring
Fn / D Fn Fountain / Drinking Ftn. **Tk** Tank or Track
Gas Gov Gas Valve Compound **Tr** Trough
GVC Gas Governor **Wd Pp** Wind Pump
GP Guide Post **Wr Pt, Wr T** Water Point, Water Tap
MH Manhole **Wks** Works (building or area)
MP, MS Mile Post or Mile Stone **W** Well

Historical Mapping & Photography included:

Mapping Type	Scale	Date	Pg
Lincolnshire	1:2,500	1886	2
Lincolnshire	1:2,500	1906	3
Ordnance Survey Plan	1:2,500	1974 - 1975	4
Large-Scale National Grid Data	1:2,500	1994	5

Historical Map - Segment C12

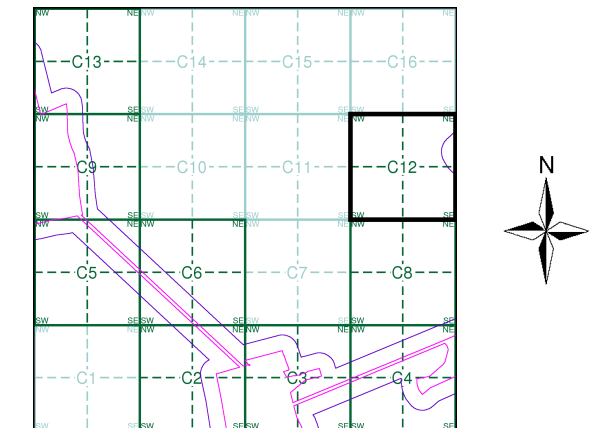

Order Details

Order Number: 298001007_1_1
 Customer Ref: 21-1098.04
 National Grid Reference: 489060, 377630
 Slice: C
 Site Area (Ha): 471.82
 Search Buffer (m): 100

Site Details

West Barton 1

Lincolnshire

Published 1886

Source map scale - 1:2,500

The historical maps shown were reproduced from maps predominantly held at the scale adopted for England, Wales and Scotland in the 1840's. In 1854 the 1:2,500 scale was adopted for mapping urban areas and by 1896 it covered the whole of what were considered to be the cultivated parts of Great Britain. The published date given below is often some years later than the surveyed date. Before 1938, all OS maps were based on the Cassini Projection, with independent surveys of a single county or group of counties, giving rise to significant inaccuracies in outlying areas.

Map Name(s) and Date(s)

060_04	1886	1:2,500
060_08	1886	1:2,500

Historical Map - Segment C12

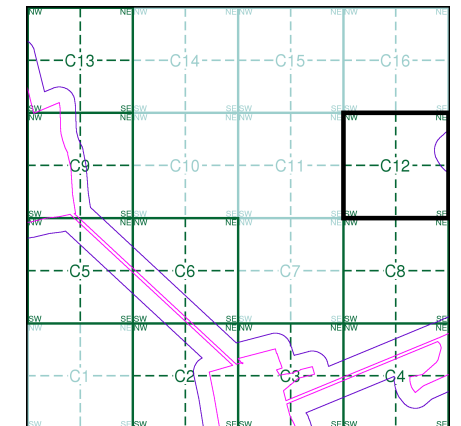

Order Details

Order Number: 298001007_1_1
 Customer Ref: 21-1098.04
 National Grid Reference: 489060, 377630
 Slice: C
 Site Area (Ha): 471.82
 Search Buffer (m): 100

Site Details

West Barton 1

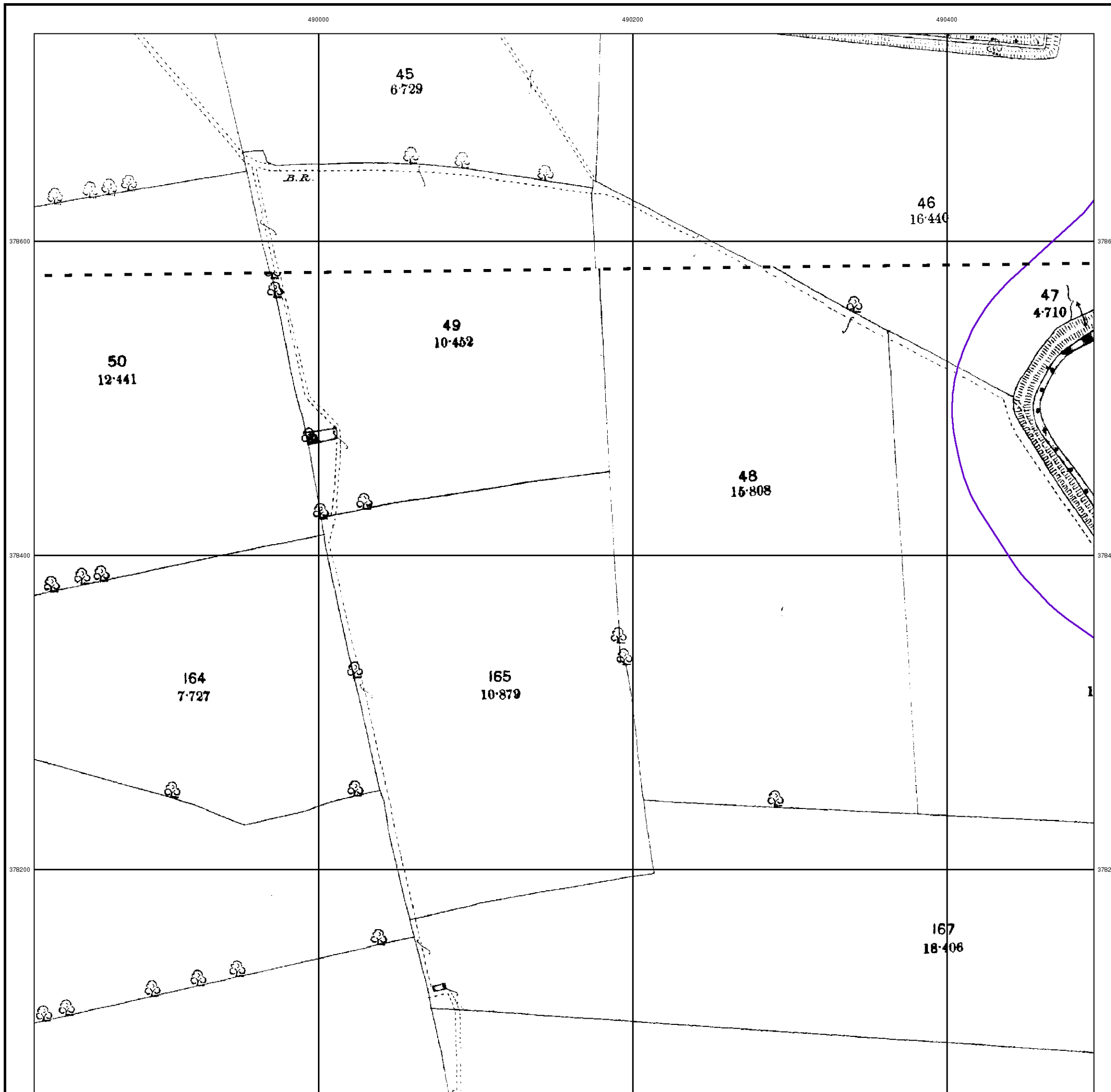

Lincolnshire

Published 1906

Source map scale - 1:2,500

The historical maps shown were reproduced from maps predominantly held at the scale adopted for England, Wales and Scotland in the 1840's. In 1854 the 1:2,500 scale was adopted for mapping urban areas and by 1896 it covered the whole of what were considered to be the cultivated parts of Great Britain. The published date given below is often some years later than the surveyed date. Before 1938, all OS maps were based on the Cassini Projection, with independent surveys of a single county or group of counties, giving rise to significant inaccuracies in outlying areas.

Map Name(s) and Date(s)

060_04	1906	1:2,500
060_08	1906	1:2,500

Historical Map - Segment C12

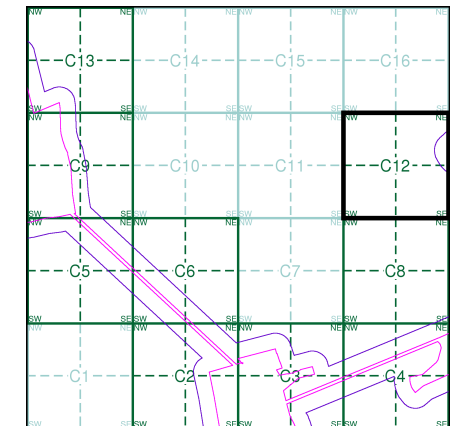

Order Details

Order Number: 298001007_1_1
 Customer Ref: 21-1098.04
 National Grid Reference: 489060, 377630
 Slice: C
 Site Area (Ha): 471.82
 Search Buffer (m): 100

Site Details

West Barton 1

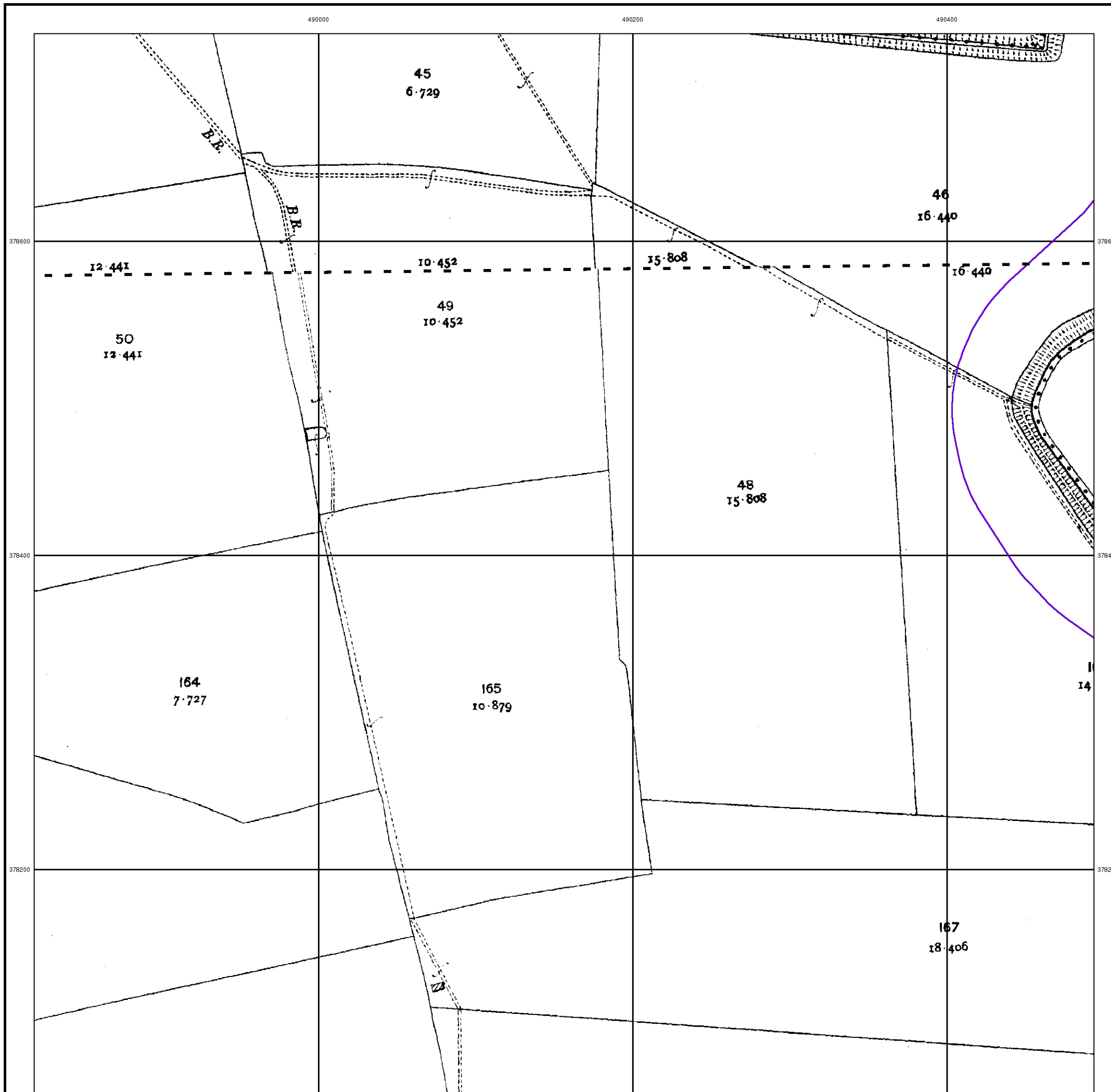

Ordnance Survey Plan
Published 1974 - 1975
Source map scale - 1:2,500

The historical maps shown were reproduced from maps predominantly held at the scale adopted for England, Wales and Scotland in the 1840's. In 1854 the 1:2,500 scale was adopted for mapping urban areas and by 1896 it covered the whole of what were considered to be the cultivated parts of Great Britain. The published date given below is often some years later than the surveyed date. Before 1938, all OS maps were based on the Cassini Projection, with independent surveys of a single county or group of counties, giving rise to significant inaccuracies in outlying areas.

Map Name(s) and Date(s)

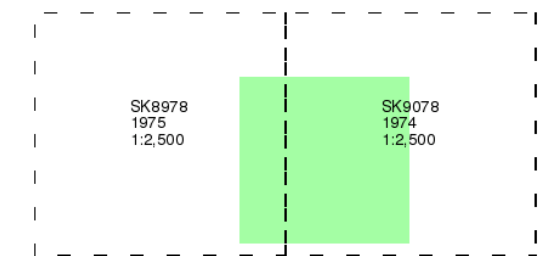

Historical Map - Segment C12

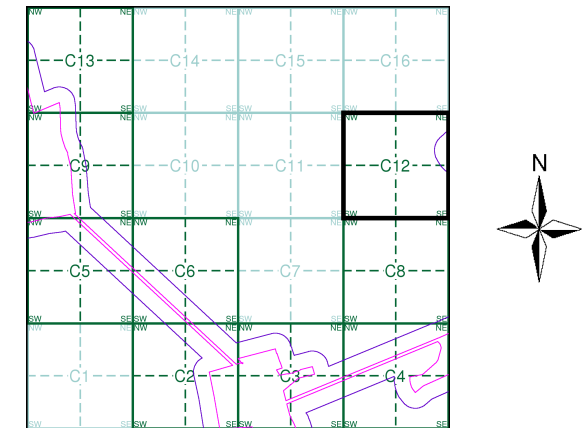

Order Details

Order Number: 298001007_1_1
 Customer Ref: 21-1098.04
 National Grid Reference: 489060, 377630
 Slice: C
 Site Area (Ha): 471.82
 Search Buffer (m): 100

Site Details

West Barton 1

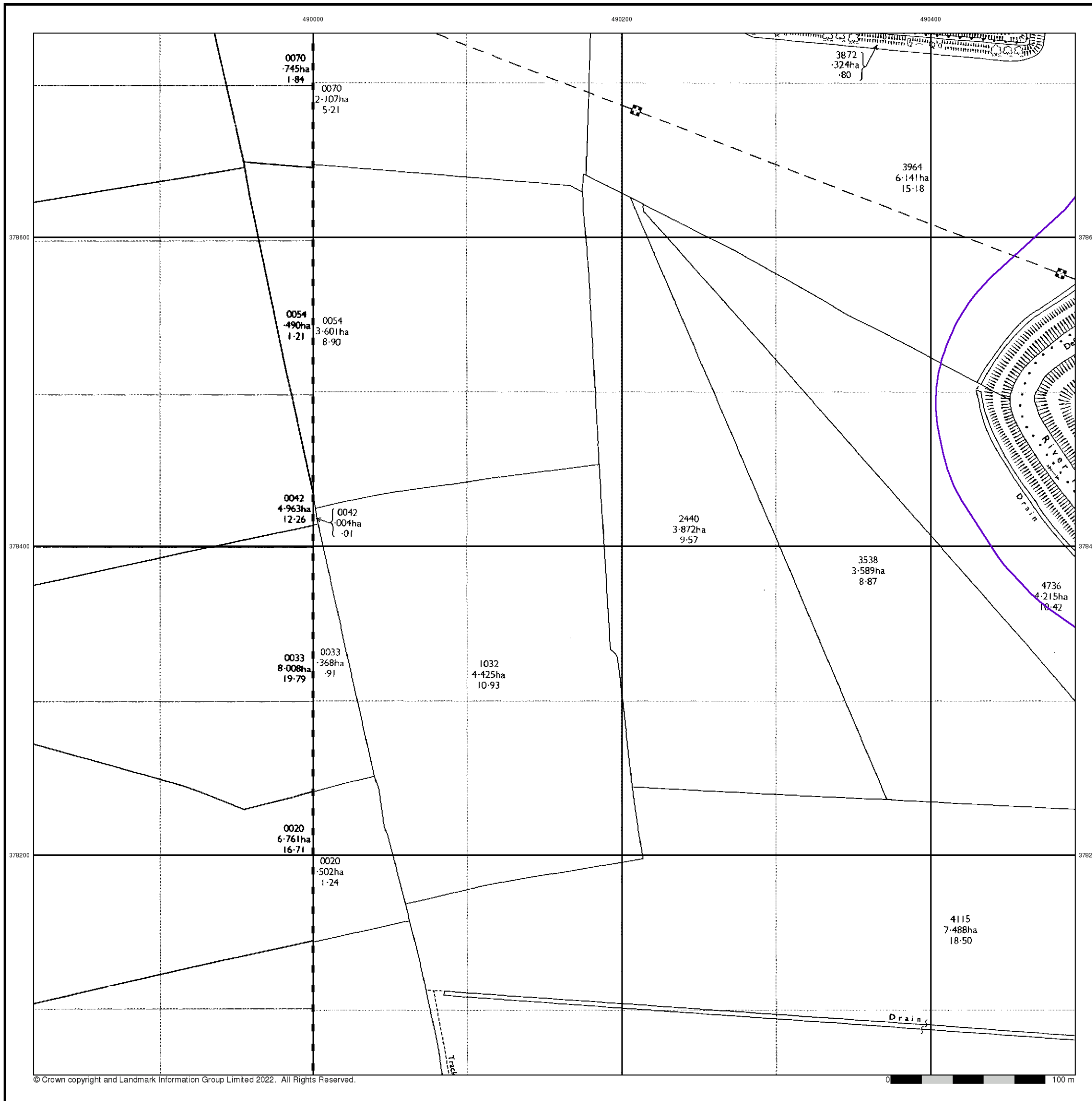

Large-Scale National Grid Data

Published 1994

Source map scale - 1:2,500

'Large Scale National Grid Data' superseded SIM cards (Ordnance Survey's 'Survey of Information on Microfilm') in 1992, and continued to be produced until 1999. These maps were the fore-runners of digital mapping and so provide detailed information on houses and roads, but tend to show less topographic features such as vegetation. These maps were produced at both 1:2,500 and 1:1,250 scales.

Map Name(s) and Date(s)

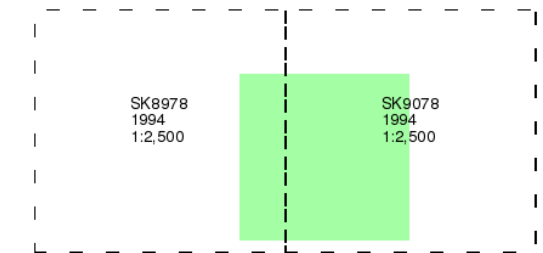

Historical Map - Segment C12

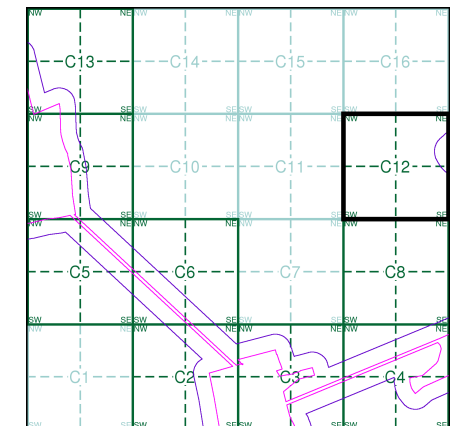

Order Details

Order Number: 298001007_1_1
 Customer Ref: 21-1098.04
 National Grid Reference: 489060, 377630
 Slice: C
 Site Area (Ha): 471.82
 Search Buffer (m): 100

Site Details

West Barton 1

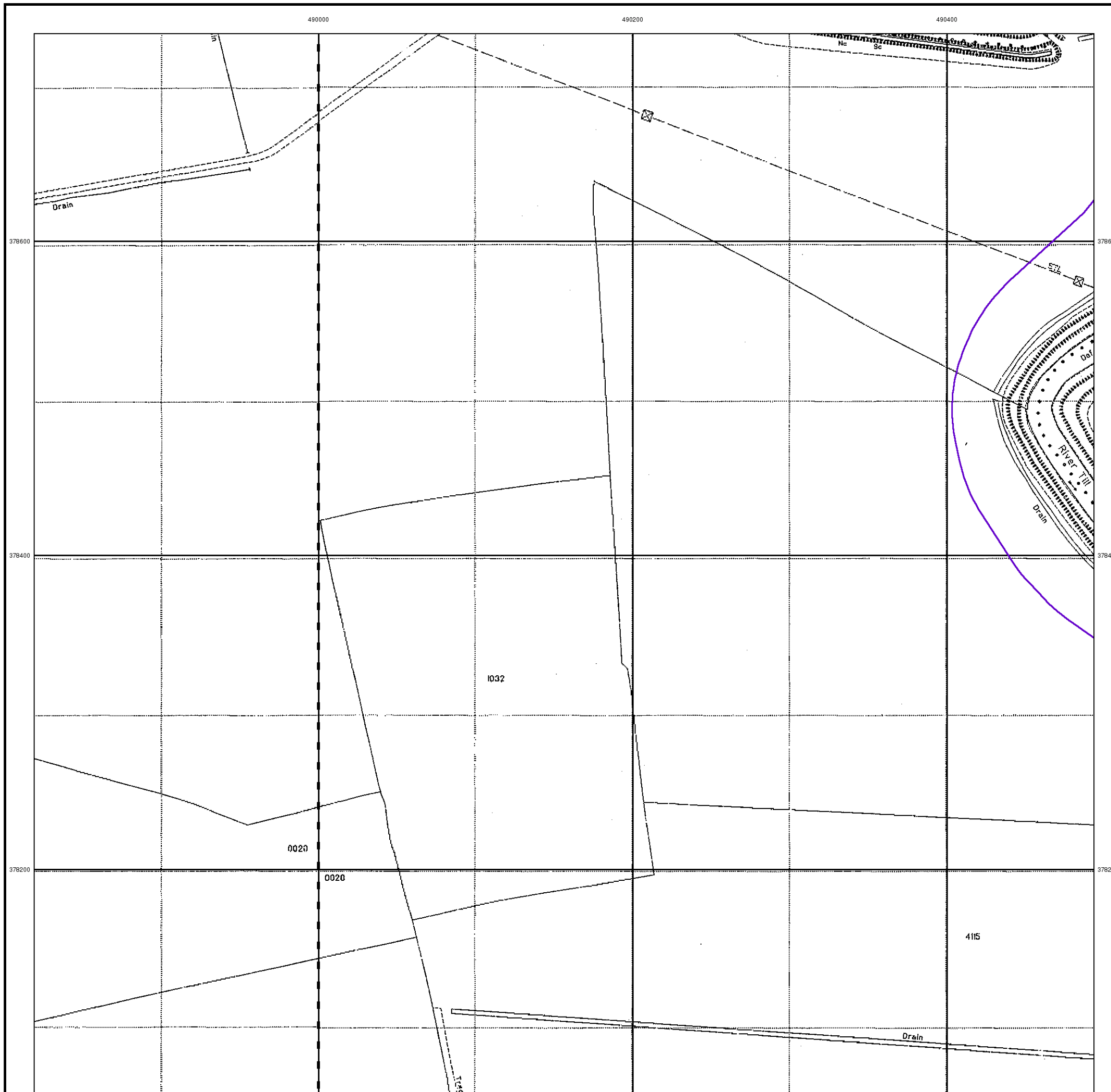

Historical Mapping Legends

Ordnance Survey County Series and Ordnance Survey Plan 1:2,500

Quarry **Gravel Pit** **Sand Pit**
Clay Pit **Shingle** **Refuse Heap**
Sloping Masonry **Flat Rock**
Marsh **Reeds** **Osiers**
Rough Pasture **Furze** **Wood**
Mixed Wood **Brushwood** **Orchard**
Fir **Ford** **Stepping Stones**
Ferry **Waterfall** **Lock**
Trig. Station **Altitude at Trig. Station**
B.M. 325.9 **Bench Mark** **Surface Level**
Arrow denotes flow of water **Antiquities (site of)**
Cutting **Embankment**
Railway crossing Road **Level Crossing** **Road crossing Railway**
Railway crossing River or Canal **Road over single stream** **Road over River or Canal**
County Boundary (Geographical)
County & Civil Parish Boundary
Administrative County & Civil Parish Boundary
County Borough Boundary (England)
County Burgh Boundary (Scotland)
Co. Boro. Bdy.
Co. Burgh Bdy.
BP BS Boundary Post or Stone **P.C.B** Police Call Box
B.R. Bridle Road **P** Pump
E.P Electricity Pylon **S.P** Signal Post
F.B. Foot Bridge **SL** Sluice
F.P. Foot Path **Sp.** Spring
G.P Guide Post or Board **T.C.B** Telephone Call Box
M.S Mile Stone **Tr.** Trough
M.P M.R Mooring Post or Ring **W** Well

Ordnance Survey Plan, Additional SIMs and Supply of Unpublished Survey Information 1:2,500 and 1:1,250

Inactive Quarry, Chalk Pit or Clay Pit **Active Quarry, Chalk Pit or Clay Pit**
Rock **Boulders**
Cliff **Slopes** **Top**
Roofed Building **Glazed Roof Building**
Sloping Masonry **Archway**
Non-Coniferous Tree (surveyed) **Coniferous Tree (surveyed)**
Non-Coniferous Trees (not surveyed) **Coniferous Trees (not surveyed)**
Orchard Tree **Scrub** **Bracken**
Coppice, Osier **Reeds** **Marsh, Saltings**
Rough Grassland **Heath** **Culvert**
Direction of water flow **Bench Mark** **Antiquity (site of)**
Cave Entrance **Triangulation Station** **Electricity Pylon**
Electricity Transmission Line
County Boundary (Geographical)
County & Civil Parish Boundary
Civil Parish Boundary
Admin. County or County Bor. Boundary
London Borough Boundary
Symbol marking point where boundary mereing changes
BH Beer House **P** Pillar, Pole or Post
BP, BS Boundary Post or Stone **PO** Post Office
Cn, C Capstan, Crane **PC** Public Convenience
Chy Chimney **PH** Public House
D Fn Drinking Fountain **Pp** Pump
EI P Electricity Pillar or Post **SB, S Br** Signal Box or Bridge
FAP Fire Alarm Pillar **SP, SL** Signal Post or Light
FB Foot Bridge **Spr** Spring
GP Guide Post **Tk** Tank or Track
H Hydrant or Hydraulic **TCB** Telephone Call Box
LC Level Crossing **TCP** Telephone Call Post
MH Manhole **Tr** Trough
MP Mile Post or Mooring Post **Wr Pt, Wr T** Water Point, Water Tap
MS Mile Stone **W** Well
NTL Normal Tidal Limit **Wd Pp** Wind Pump

Large-Scale National Grid Data 1:2,500 and 1:1,250

Cliff **Slopes** **Top**
Rock **Rock (scattered)**
Boulders **Boulders (scattered)**
Positioned Boulder **Scree**
Non-Coniferous Tree (surveyed) **Coniferous Tree (surveyed)**
Non-Coniferous Trees (not surveyed) **Coniferous Trees (not surveyed)**
Orchard Tree **Scrub** **Bracken**
Coppice, Osier **Reeds** **Marsh, Saltings**
Rough Grassland **Heath** **Culvert**
Direction of water flow **Triangulation Station** **Antiquity (site of)**
Electricity Transmission Line **Electricity Pylon**
B.M. 231.60m Bench Mark **Buildings with Building Seed**
Roofed Building **Glazed Roof Building**
Civil parish/community boundary
District boundary
County boundary
Boundary post/stone
Boundary mereing symbol (note: these always appear in opposed pairs or groups of three)
Bks Barracks **P** Pillar, Pole or Post
Bty Battery **PO** Post Office
Cemy Cemetery **PC** Public Convenience
Chy Chimney **Pp** Pump
Cis Cistern **Ppg Sta** Pumping Station
Dismtd Rly Dismantled Railway **PW** Place of Worship
EI Gen Sta Electricity Generating Station **Sewage Ppg Sta** Sewage Pumping Station
EI P Electricity Pole, Pillar **SB, S Br** Signal Box or Bridge
EI Sub Sta Electricity Sub Station **SP, SL** Signal Post or Light
FB Filter Bed **Spr** Spring
Fn / D Fn Fountain / Drinking Ftn. **Tk** Tank or Track
Gas Gov Gas Valve Compound **Tr** Trough
GVC Gas Governor **Wd Pp** Wind Pump
GP Guide Post **Wr Pt, Wr T** Water Point, Water Tap
MH Manhole **Wks** Works (building or area)
MP, MS Mile Post or Mile Stone **W** Well

Historical Mapping & Photography included:

Mapping Type	Scale	Date	Pg
Lincolnshire	1:2,500	1886	2
Lincolnshire	1:2,500	1906	3
Ordnance Survey Plan	1:2,500	1975	4
Large-Scale National Grid Data	1:2,500	1994	5

Historical Map - Segment C13

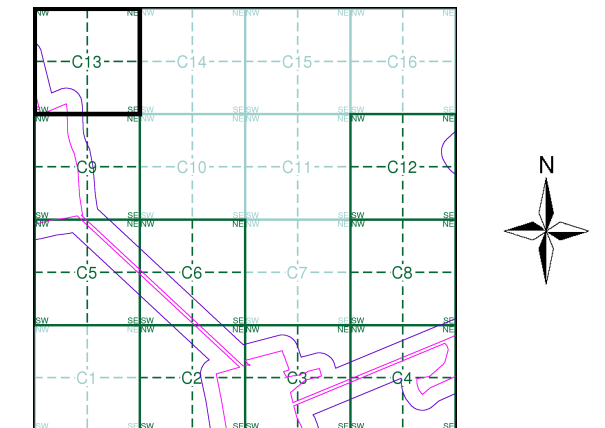

Order Details

Order Number: 298001007_1_1
 Customer Ref: 21-1098.04
 National Grid Reference: 489060, 377630
 Slice: C
 Site Area (Ha): 471.82
 Search Buffer (m): 100

Site Details

West Barton 1

Lincolnshire

Published 1886

Source map scale - 1:2,500

The historical maps shown were reproduced from maps predominantly held at the scale adopted for England, Wales and Scotland in the 1840's. In 1854 the 1:2,500 scale was adopted for mapping urban areas and by 1896 it covered the whole of what were considered to be the cultivated parts of Great Britain. The published date given below is often some years later than the surveyed date. Before 1938, all OS maps were based on the Cassini Projection, with independent surveys of a single county or group of counties, giving rise to significant inaccuracies in outlying areas.

Map Name(s) and Date(s)

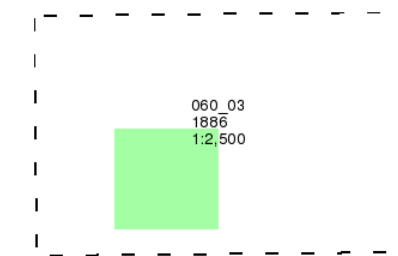

Historical Map - Segment C13

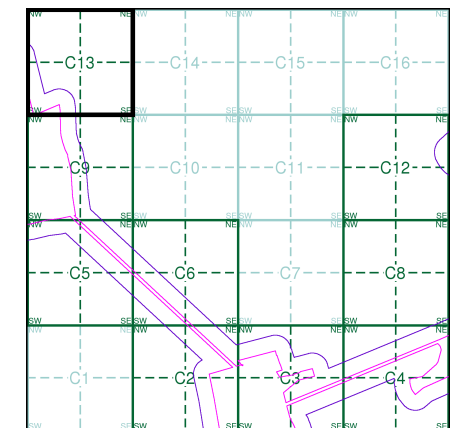

Order Details

Order Number: 298001007_1_1
 Customer Ref: 21-1098.04
 National Grid Reference: 489060, 377630
 Slice: C
 Site Area (Ha): 471.82
 Search Buffer (m): 100

Site Details

West Barton 1

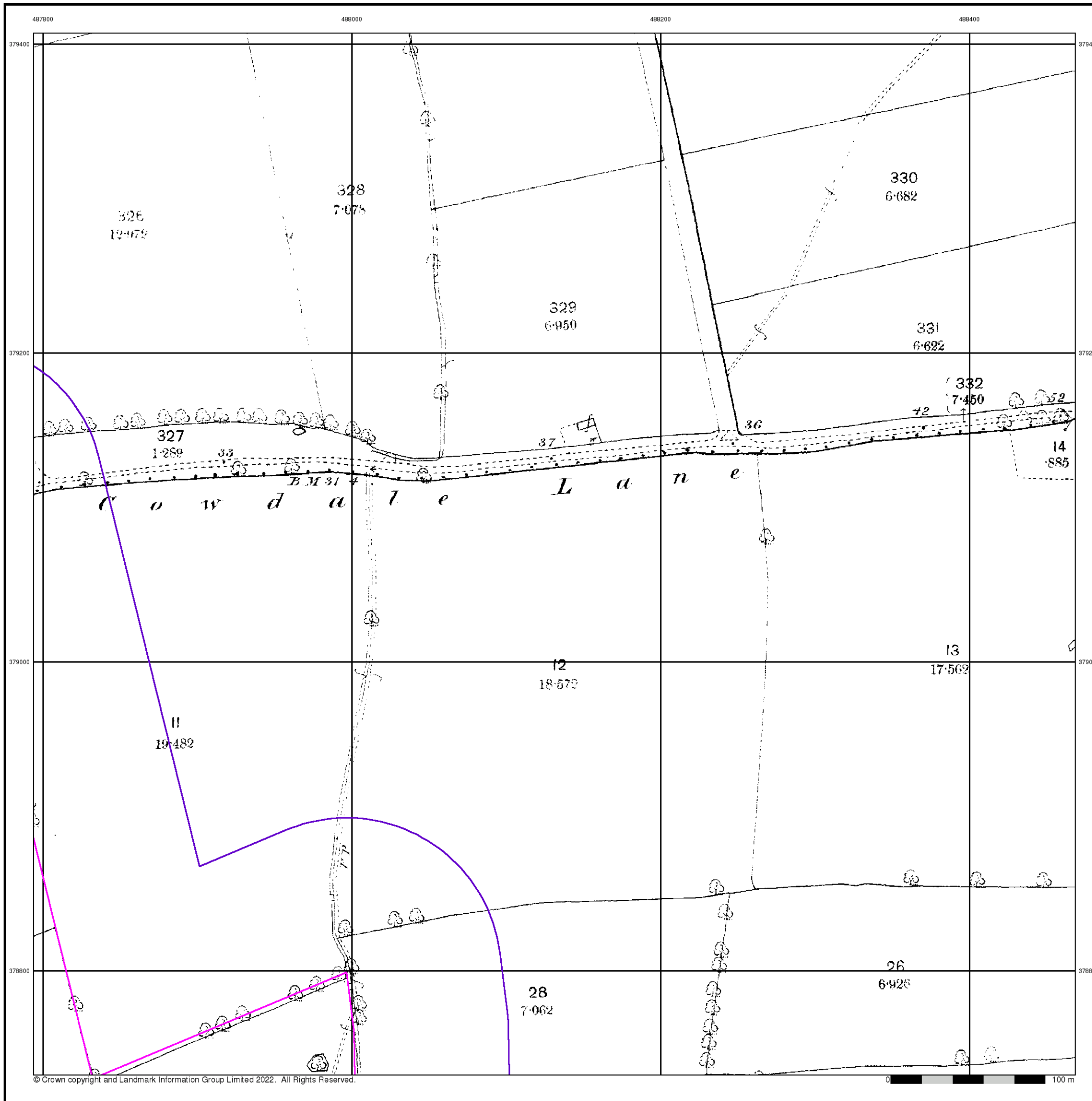

Lincolnshire

Published 1906

Source map scale - 1:2,500

The historical maps shown were reproduced from maps predominantly held at the scale adopted for England, Wales and Scotland in the 1840's. In 1854 the 1:2,500 scale was adopted for mapping urban areas and by 1896 it covered the whole of what were considered to be the cultivated parts of Great Britain. The published date given below is often some years later than the surveyed date. Before 1938, all OS maps were based on the Cassini Projection, with independent surveys of a single county or group of counties, giving rise to significant inaccuracies in outlying areas.

Map Name(s) and Date(s)

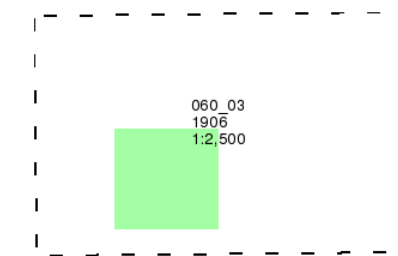

Historical Map - Segment C13

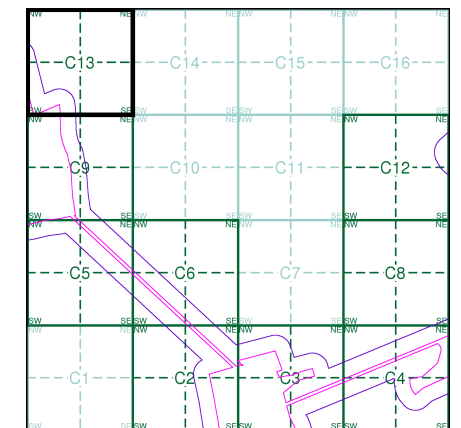

Order Details

Order Number: 298001007_1_1
 Customer Ref: 21-1098.04
 National Grid Reference: 489060, 377630
 Slice: C
 Site Area (Ha): 471.82
 Search Buffer (m): 100

Site Details

West Barton 1

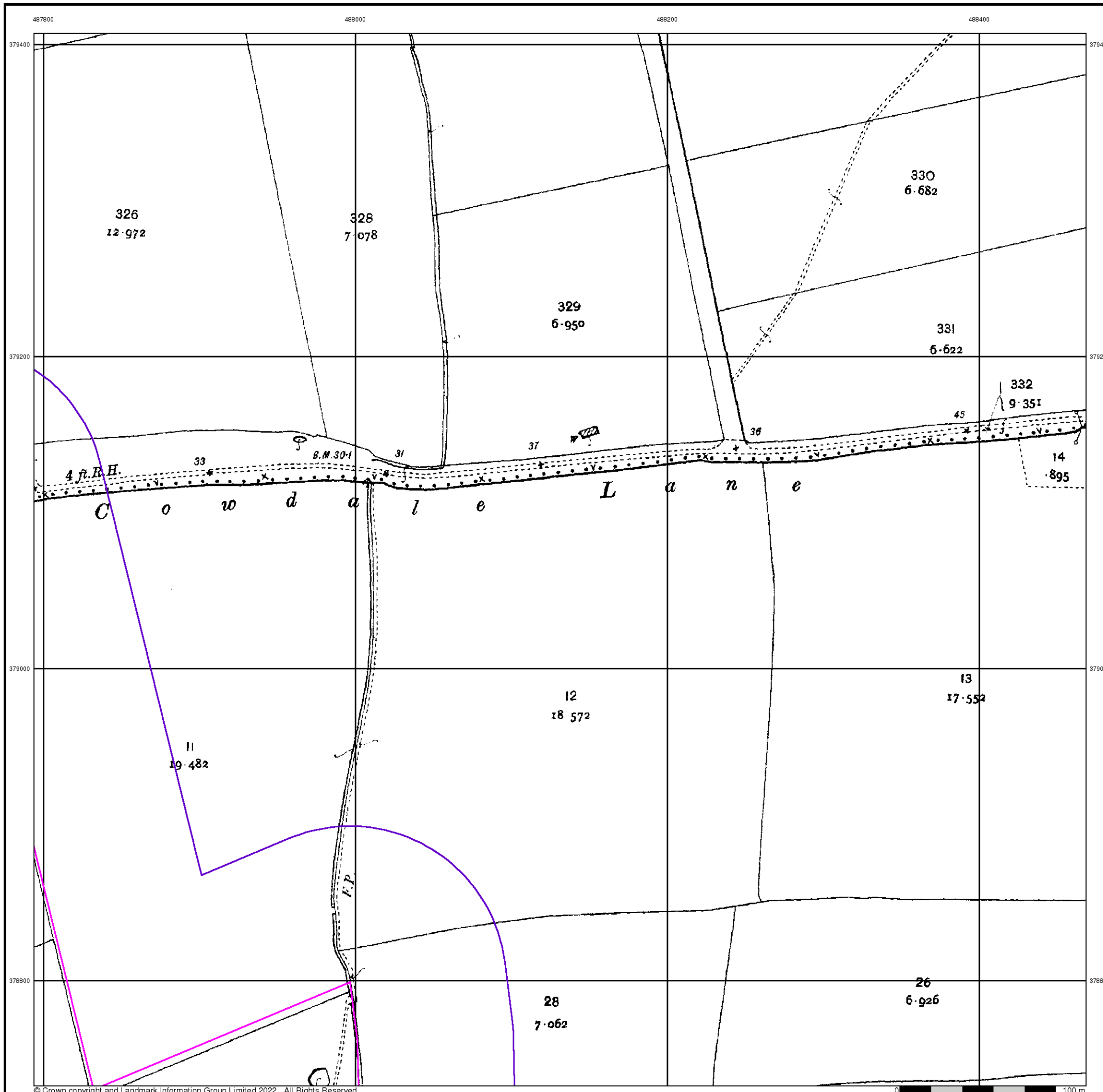

Ordnance Survey Plan

Published 1975

Source map scale - 1:2,500

The historical maps shown were reproduced from maps predominantly held at the scale adopted for England, Wales and Scotland in the 1840's. In 1854 the 1:2,500 scale was adopted for mapping urban areas and by 1896 it covered the whole of what were considered to be the cultivated parts of Great Britain. The published date given below is often some years later than the surveyed date. Before 1938, all OS maps were based on the Cassini Projection, with independent surveys of a single county or group of counties, giving rise to significant inaccuracies in outlying areas.

Map Name(s) and Date(s)

SK8779 1975 1:2,500	SK8879 1975 1:2,500
SK8778 1975 1:2,500	SK8878 1975 1:2,500

Historical Map - Segment C13

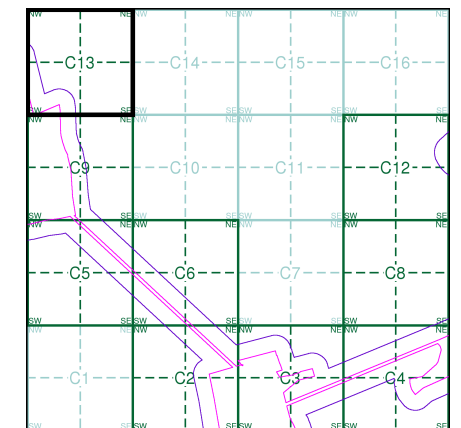

Order Details

Order Number: 298001007_1_1
 Customer Ref: 21-1098.04
 National Grid Reference: 489060, 377630
 Slice: C
 Site Area (Ha): 471.82
 Search Buffer (m): 100

Site Details

West Barton 1

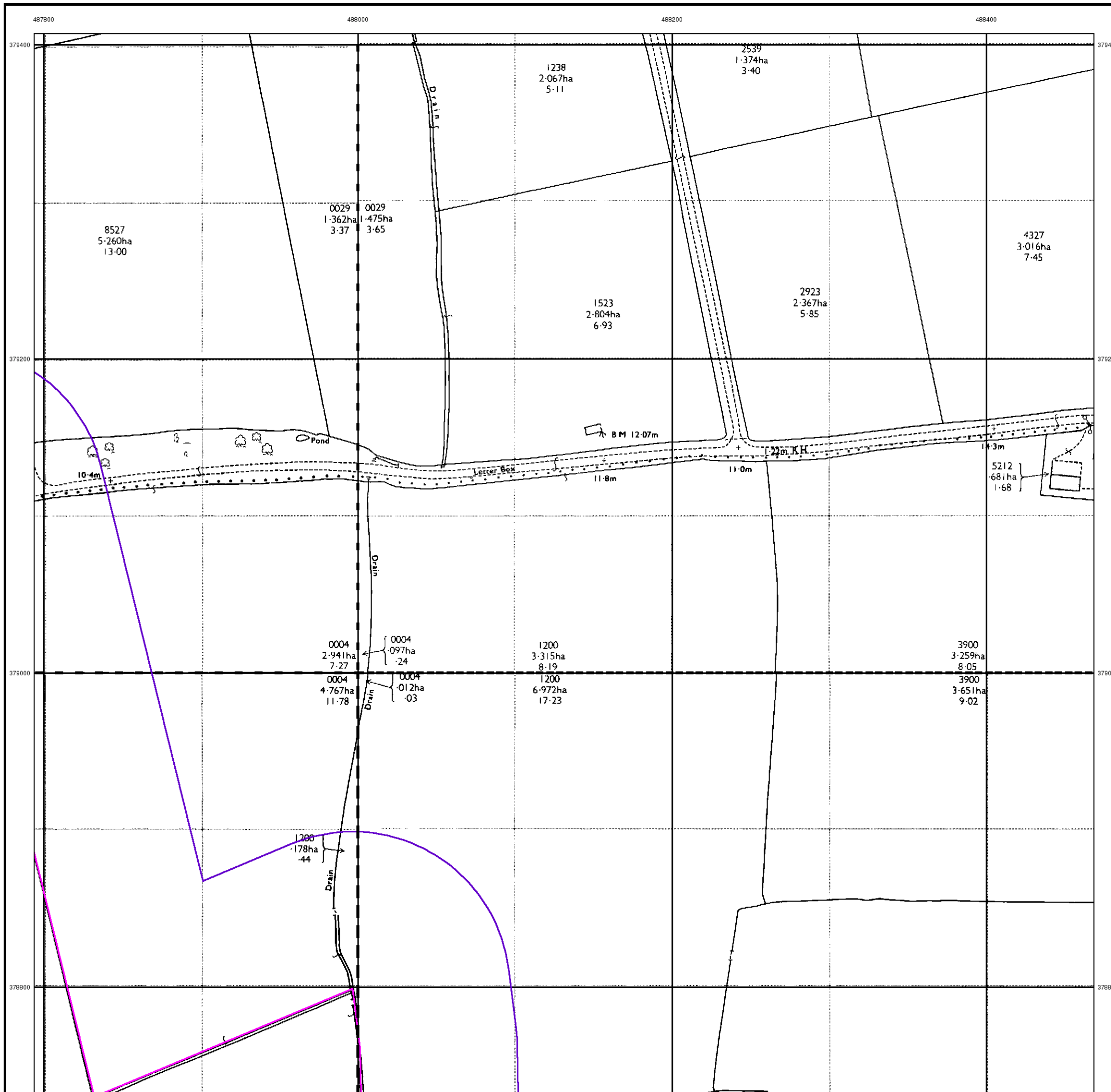

Large-Scale National Grid Data

Published 1994

Source map scale - 1:2,500

'Large Scale National Grid Data' superseded SIM cards (Ordnance Survey's 'Survey of Information on Microfilm') in 1992, and continued to be produced until 1999. These maps were the fore-runners of digital mapping and so provide detailed information on houses and roads, but tend to show less topographic features such as vegetation. These maps were produced at both 1:2,500 and 1:1,250 scales.

Map Name(s) and Date(s)

SK8779	SK8879
1994	1994
1:2,500	1:2,500
SK8778	SK8878
1994	1994
1:2,500	1:2,500

Historical Map - Segment C13

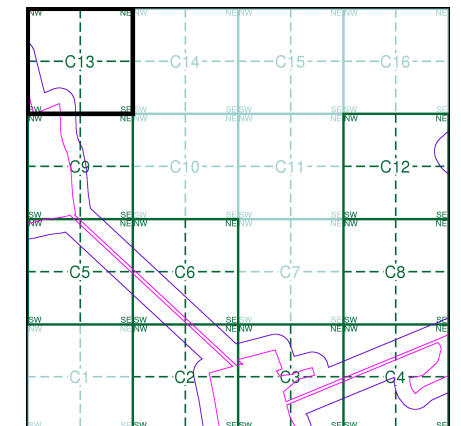

Order Details

Order Number: 298001007_1_1
 Customer Ref: 21-1098.04
 National Grid Reference: 489060, 377630
 Slice: C
 Site Area (Ha): 471.82
 Search Buffer (m): 100

Site Details

West Barton 1

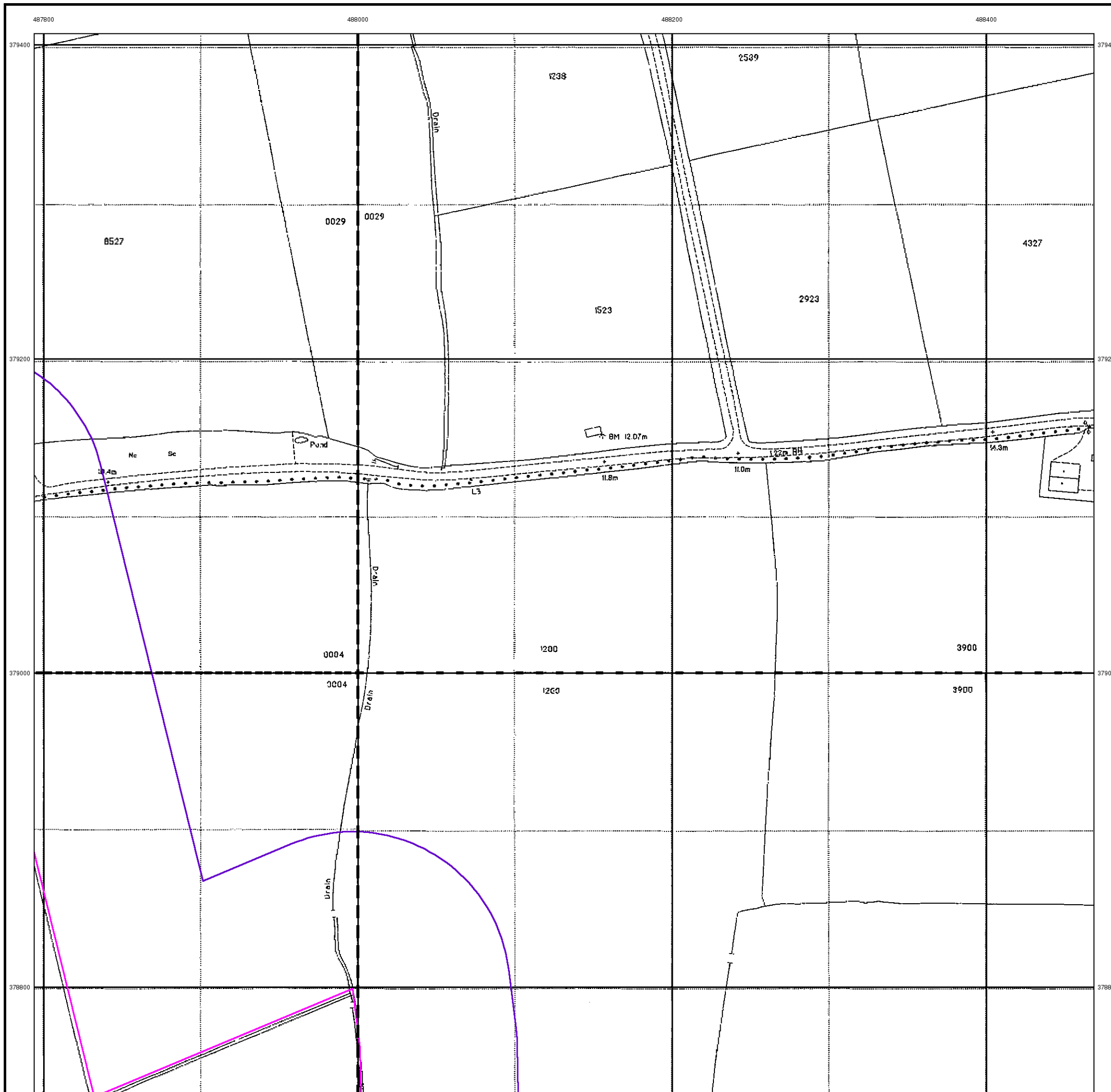

Historical Mapping Legends

Ordnance Survey County Series 1:10,560

- Gravel Pit
- Sand Pit
- Other Pits
- Quarry
- Shingle
- Orchard
- Osiers
- Reeds
- Marsh
- Mixed Wood
- Deciduous
- Brushwood
- Fir
- Furze
- Rough Pasture
- Arrow denotes flow of water
- Trigonometrical Station
- Site of Antiquities
- Bench Mark
- Pump, Guide Post, Signal Post
- Well, Spring, Boundary Post
- 285** Surface Level
- Sketched Contour
- Instrumental Contour
- Main Roads
- Minor Roads
- Sunken Road
- Raised Road
- Road over Railway
- Railway over River
- Railway over Road
- Level Crossing
- Road over River or Canal
- Road over Stream
- Road over Stream
- County Boundary (Geographical)
- County & Civil Parish Boundary
- Administrative County & Civil Parish Boundary
- County Borough Boundary (England)
- County Burgh Boundary (Scotland)
- Rural District Boundary
- Civil Parish Boundary

Ordnance Survey Plan 1:10,000

- Chalk Pit, Clay Pit or Quarry
- Gravel Pit
- Sand Pit
- Disused Pit or Quarry
- Refuse or Slag Heap
- Lake, Loch or Pond
- Dunes
- Boulders
- Coniferous Trees
- Non-Coniferous Trees
- Orchard
- Scrub
- Coppice
- Bracken
- Heath
- Rough Grassland
- Marsh
- Reeds
- Saltings
- Building
- Glasshouse
- Sloping Masonry
- Pylon
- Electricity Transmission Line
- Pole
- Cutting
- Embankment
- Standard Gauge Multiple Track
- Standard Gauge Single Track
- Siding, Tramway or Mineral Line
- Narrow Gauge
- Geographical County
- Administrative County, County Borough or County of City
- Municipal Borough, Urban or Rural District, Burgh or District Council
- Borough, Burgh or County Constituency
- Civil Parish
- BP, BS** Boundary Post or Stone
- Ch** Church
- CH** Club House
- F E Sta** Fire Engine Station
- FB** Foot Bridge
- Fn** Fountain
- GP** Guide Post
- MP** Mile Post
- MS** Mile Stone
- Pol Sta** Police Station
- PO** Post Office
- PC** Public Convenience
- PH** Public House
- SB** Signal Box
- Spr** Spring
- TCB** Telephone Call Box
- TCP** Telephone Call Post
- W** Well

1:10,000 Raster Mapping

- Gravel Pit
- Rock
- Boulders
- Shingle
- Sand
- Slopes
- General detail
- Overhead detail
- Multi-track railway
- County boundary (England only)
- District, Unitary, Metropolitan, London Borough boundary
- Refuse tip or slag heap
- Rock (scattered)
- Boulders (scattered)
- Mud
- Sand Pit
- Top of cliff
- Underground detail
- Narrow gauge railway
- Single track railway
- Civil, parish or community boundary
- Constituency boundary
- Area of wooded vegetation
- Non-coniferous trees
- Coniferous trees
- Positioned tree
- Coppice or Osiers
- Heath
- Marsh, Salt Marsh or Reeds
- Flow arrows
- Mean high water (springs)
- Mean low water (springs)
- Electricity transmission line (with poles)
- Telephone line (where shown)
- Bench mark (where shown)
- Point feature (e.g. Guide Post or Mile Stone)
- Site of (antiquity)
- General Building
- Important Building



Historical Mapping & Photography included:

Mapping Type	Scale	Date	Pg
Lincolnshire	1:10,560	1885 - 1886	2
Nottinghamshire	1:10,560	1900	3
Lincolnshire	1:10,560	1906 - 1907	4
Lincolnshire	1:10,560	1907	5
Lincolnshire	1:10,560	1922	6
Lincolnshire	1:10,560	1922	7
Lincolnshire	1:10,560	1938 - 1950	8
Lincolnshire	1:10,560	1950	9
Ordnance Survey Plan	1:10,000	1956	10
Ordnance Survey Plan	1:10,000	1976	11
10K Raster Mapping	1:10,000	2000	12
Street View	Variable		13

Historical Map - Slice D

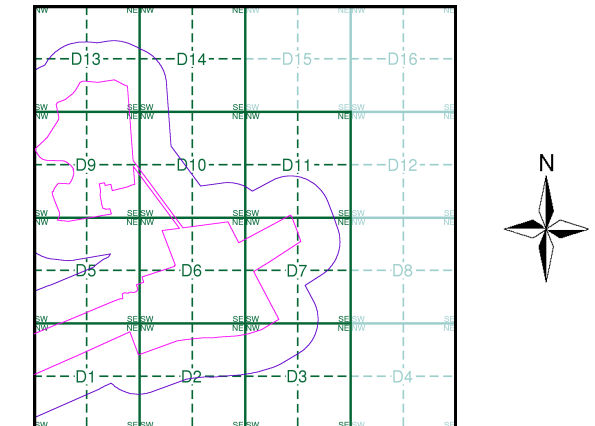

Order Details

Order Number: 298001007_1_1
 Customer Ref: 21-1098.04
 National Grid Reference: 491280, 377900
 Slice: D
 Site Area (Ha): 471.82
 Search Buffer (m): 250

Site Details

West Barton 1



Tel: 0844 844 9952
 Fax: 0844 844 9951
 Web: [REDACTED]

Lincolnshire

Published 1885 - 1886

Source map scale - 1:10,560

The historical maps shown were reproduced from maps predominantly held at the scale adopted for England, Wales and Scotland in the 1840's. In 1854 the 1:2,500 scale was adopted for mapping urban areas; these maps were used to update the 1:10,560 maps. The published date given therefore is often some years later than the surveyed date. Before 1938, all OS maps were based on the Cassini Projection, with independent surveys of a single county or group of counties, giving rise to significant inaccuracies in outlying areas. In the late 1940's, a Provisional Edition was produced, which updated the 1:10,560 mapping from a number of sources. The maps appear unfinished - with all military camps and other strategic sites removed. These maps were initially overprinted with the National Grid. In 1970, the first 1:10,000 maps were produced using the Transverse Mercator Projection. The revision process continued until recently, with new editions appearing every 10 years or so for urban areas.

Map Name(s) and Date(s)

060NE 1885 1:10,560	061NW 1886 1:10,560
060SE 1885 1:10,560	061SW 1886 1:10,560

Historical Map - Slice D

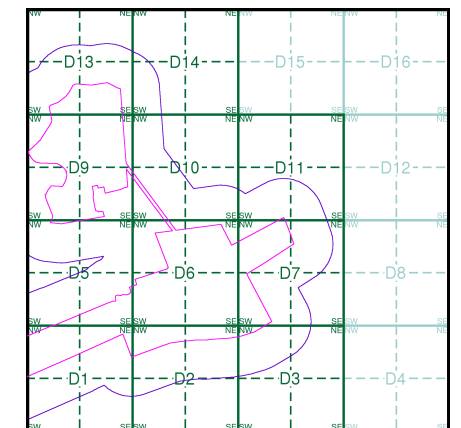

Order Details

Order Number: 298001007_1_1
 Customer Ref: 21-1098.04
 National Grid Reference: 491280, 377900
 Slice: D
 Site Area (Ha): 471.82
 Search Buffer (m): 250

Site Details

West Barton 1

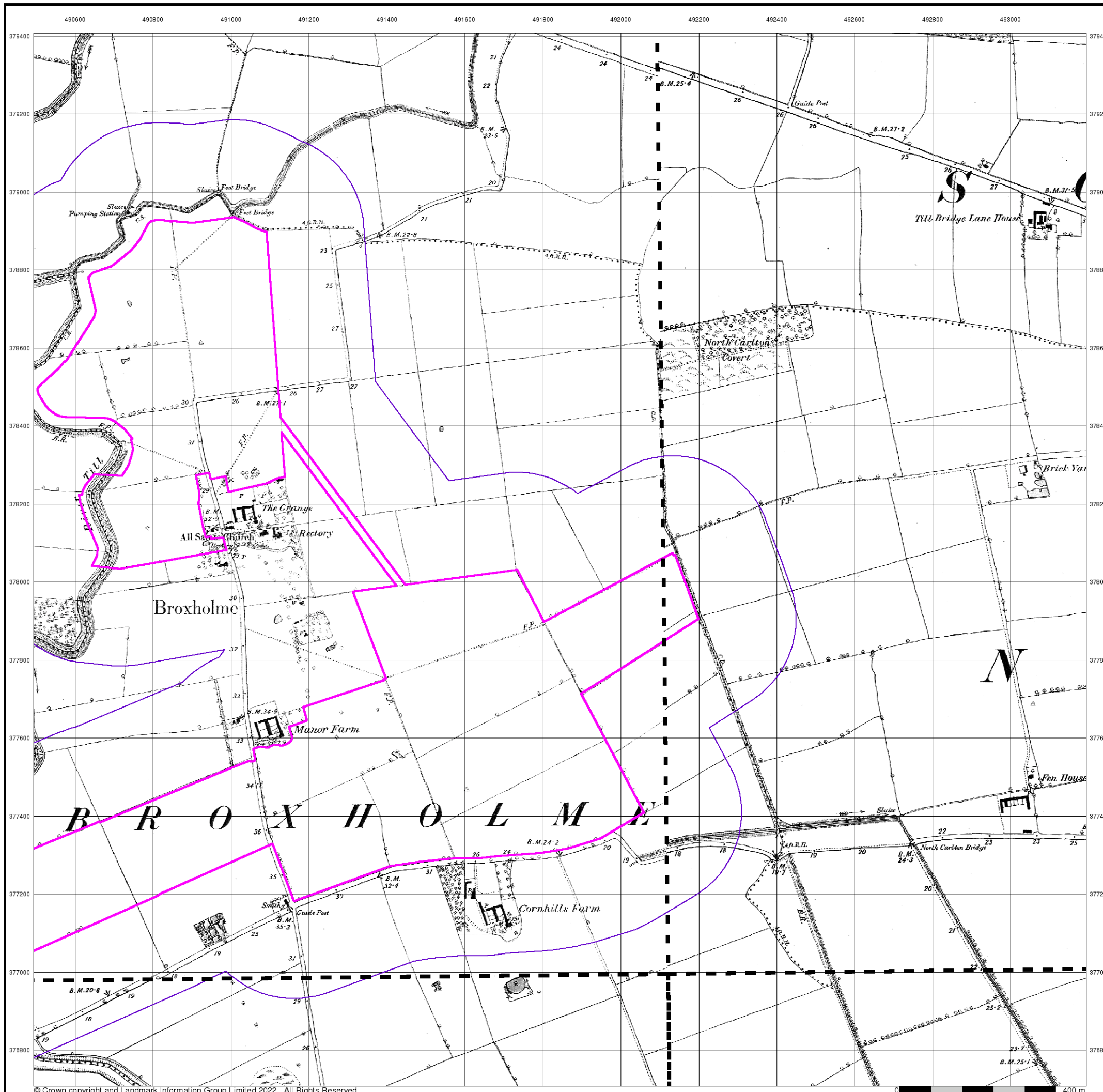

Nottinghamshire

Published 1900

Source map scale - 1:10,560

The historical maps shown were reproduced from maps predominantly held at the scale adopted for England, Wales and Scotland in the 1840's. In 1854 the 1:2,500 scale was adopted for mapping urban areas; these maps were used to update the 1:10,560 maps. The published date given therefore is often some years later than the surveyed date. Before 1938, all OS maps were based on the Cassini Projection, with independent surveys of a single county or group of counties, giving rise to significant inaccuracies in outlying areas. In the late 1940's, a Provisional Edition was produced, which updated the 1:10,560 mapping from a number of sources. The maps appear unfinished - with all military camps and other strategic sites removed. These maps were initially overprinted with the National Grid. In 1970, the first 1:10,000 maps were produced using the Transverse Mercator Projection. The revision process continued until recently, with new editions appearing every 10 years or so for urban areas.

Map Name(s) and Date(s)

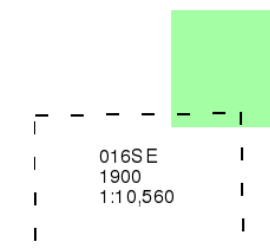

Historical Map - Slice D

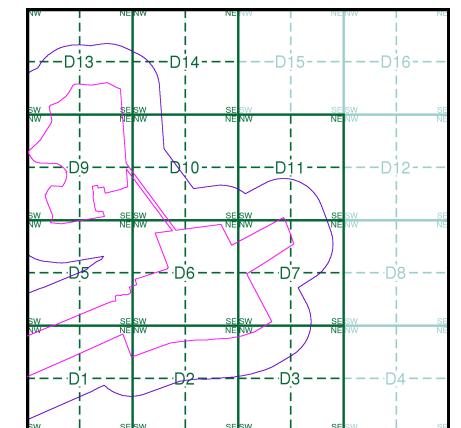

Order Details

Order Number: 298001007_1_1
 Customer Ref: 21-1098.04
 National Grid Reference: 491280, 377900
 Slice: D
 Site Area (Ha): 471.82
 Search Buffer (m): 250

Site Details

West Barton 1

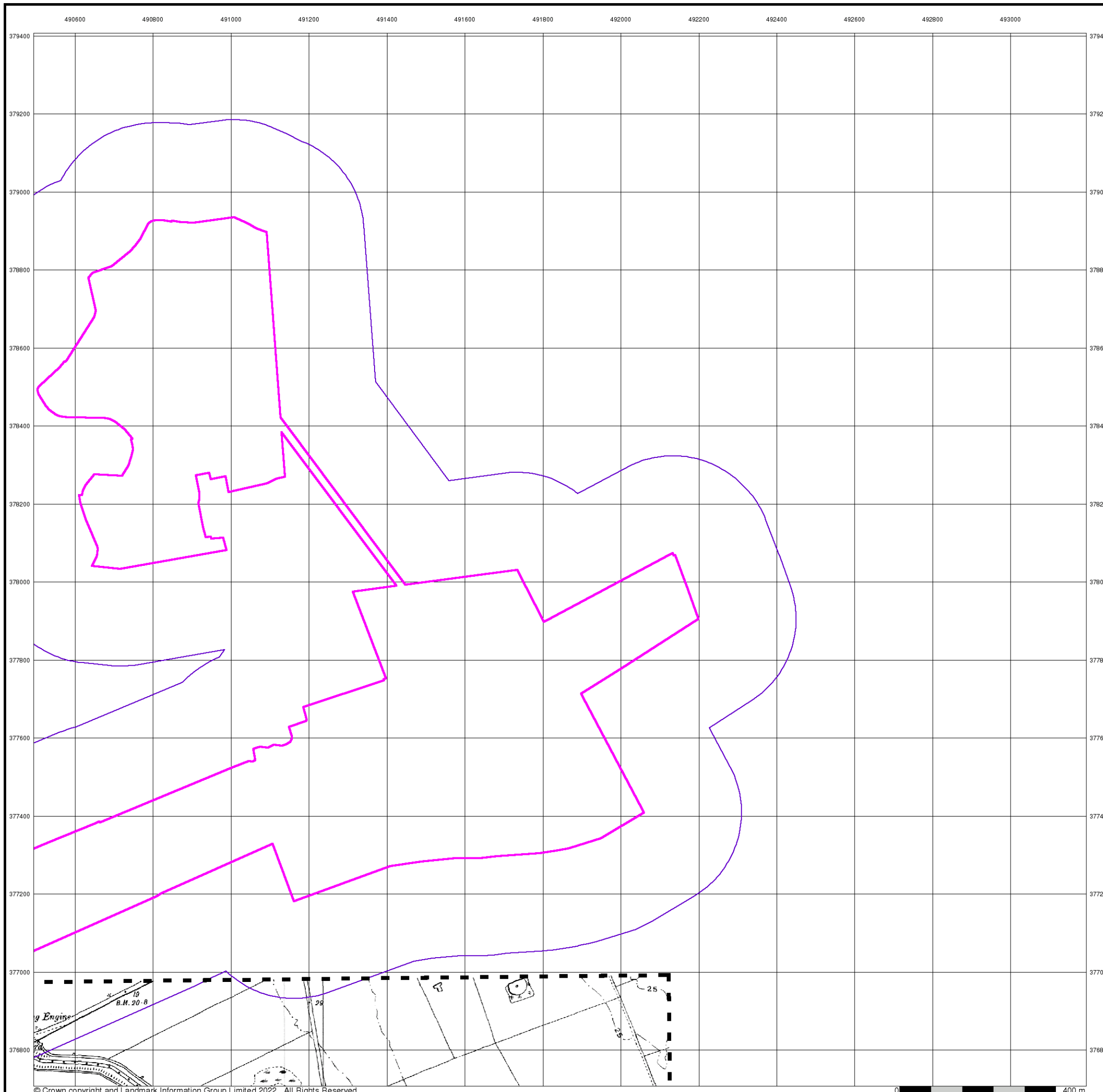

Lincolnshire

Published 1906 - 1907

Source map scale - 1:10,560

The historical maps shown were reproduced from maps predominantly held at the scale adopted for England, Wales and Scotland in the 1840's. In 1854 the 1:2,500 scale was adopted for mapping urban areas; these maps were used to update the 1:10,560 maps. The published date given therefore is often some years later than the surveyed date. Before 1938, all OS maps were based on the Cassini Projection, with independent surveys of a single county or group of counties, giving rise to significant inaccuracies in outlying areas. In the late 1940's, a Provisional Edition was produced, which updated the 1:10,560 mapping from a number of sources. The maps appear unfinished - with all military camps and other strategic sites removed. These maps were initially overprinted with the National Grid. In 1970, the first 1:10,000 maps were produced using the Transverse Mercator Projection. The revision process continued until recently, with new editions appearing every 10 years or so for urban areas.

Map Name(s) and Date(s)

060NE 1907 1:10,560	061NW 1907 1:10,560
060SE 1906 1:10,560	061SW 1907 1:10,560

Historical Map - Slice D

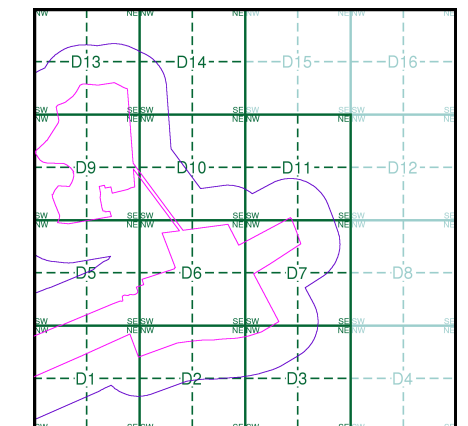

Order Details

Order Number: 298001007_1_1
 Customer Ref: 21-1098.04
 National Grid Reference: 491280, 377900
 Slice: D
 Site Area (Ha): 471.82
 Search Buffer (m): 250

Site Details

West Barton 1

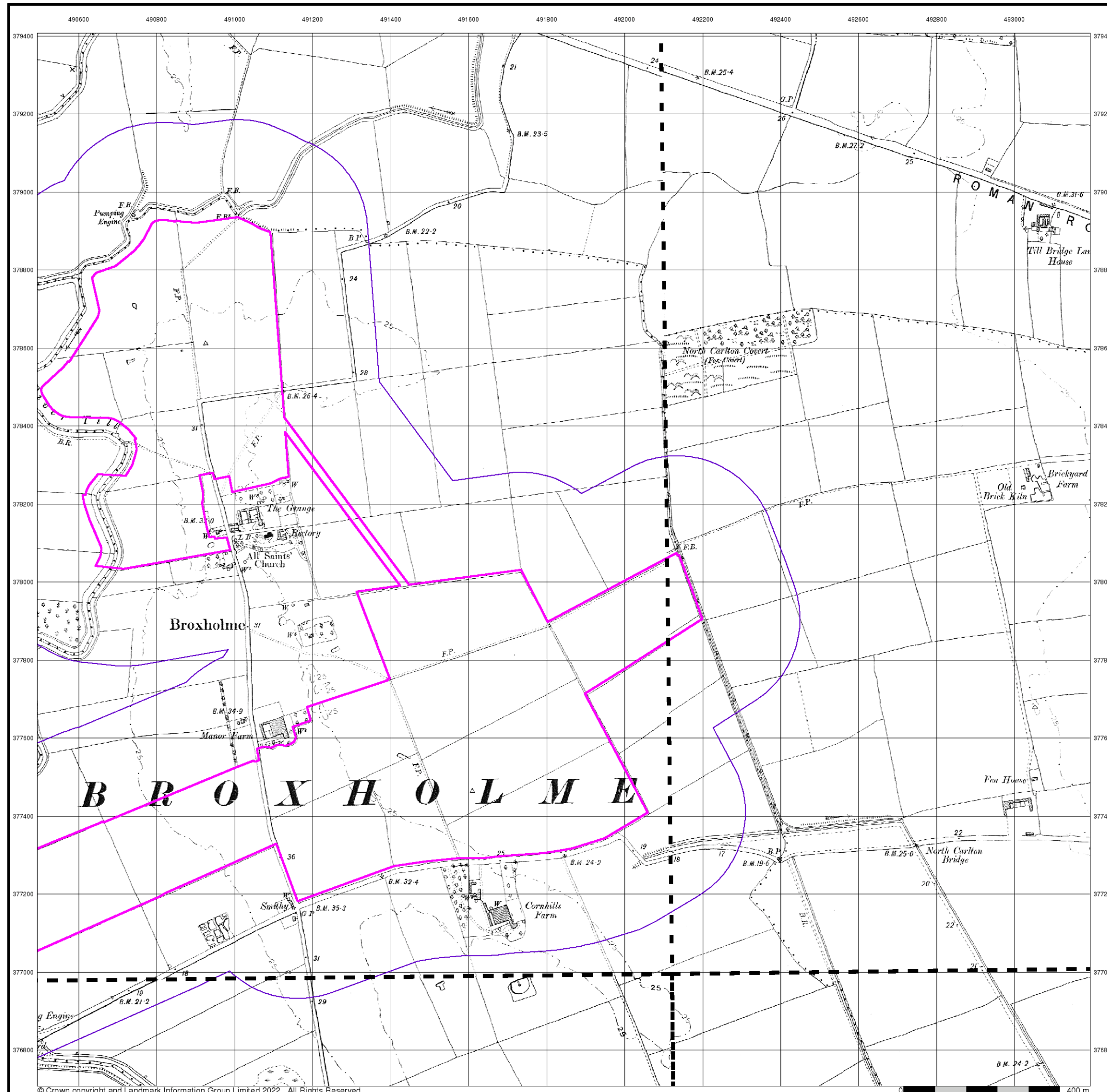

Lincolnshire

Published 1907

Source map scale - 1:10,560

The historical maps shown were reproduced from maps predominantly held at the scale adopted for England, Wales and Scotland in the 1840's. In 1854 the 1:2,500 scale was adopted for mapping urban areas; these maps were used to update the 1:10,560 maps. The published date given therefore is often some years later than the surveyed date. Before 1938, all OS maps were based on the Cassini Projection, with independent surveys of a single county or group of counties, giving rise to significant inaccuracies in outlying areas. In the late 1940's, a Provisional Edition was produced, which updated the 1:10,560 mapping from a number of sources. The maps appear unfinished - with all military camps and other strategic sites removed. These maps were initially overprinted with the National Grid. In 1970, the first 1:10,000 maps were produced using the Transverse Mercator Projection. The revision process continued until recently, with new editions appearing every 10 years or so for urban areas.

Map Name(s) and Date(s)

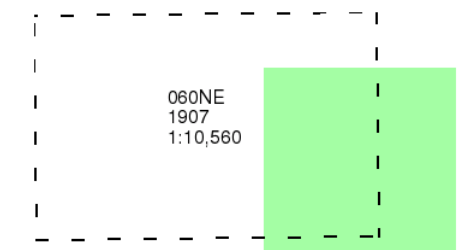

Historical Map - Slice D

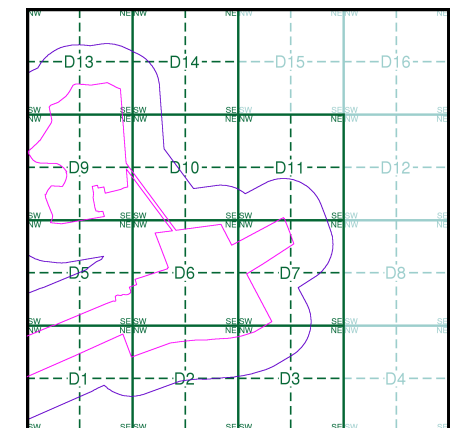

Order Details

Order Number: 298001007_1_1
 Customer Ref: 21-1098.04
 National Grid Reference: 491280, 377900
 Slice: D
 Site Area (Ha): 471.82
 Search Buffer (m): 250

Site Details

West Barton 1

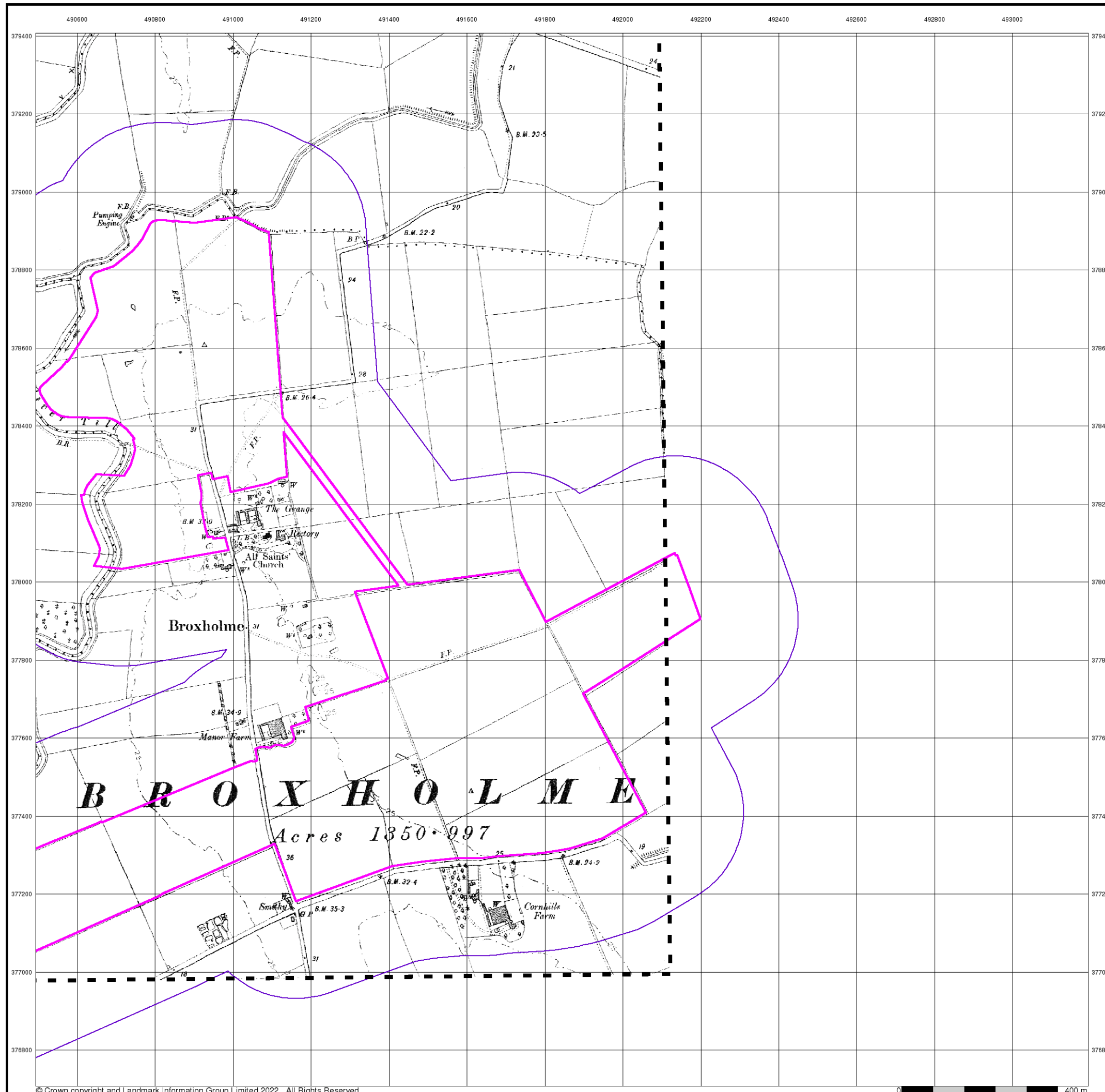

Lincolnshire

Published 1922

Source map scale - 1:10,560

The historical maps shown were reproduced from maps predominantly held at the scale adopted for England, Wales and Scotland in the 1840's. In 1854 the 1:2,500 scale was adopted for mapping urban areas; these maps were used to update the 1:10,560 maps. The published date given therefore is often some years later than the surveyed date. Before 1938, all OS maps were based on the Cassini Projection, with independent surveys of a single county or group of counties, giving rise to significant inaccuracies in outlying areas. In the late 1940's, a Provisional Edition was produced, which updated the 1:10,560 mapping from a number of sources. The maps appear unfinished - with all military camps and other strategic sites removed. These maps were initially overprinted with the National Grid. In 1970, the first 1:10,000 maps were produced using the Transverse Mercator Projection. The revision process continued until recently, with new editions appearing every 10 years or so for urban areas.

Map Name(s) and Date(s)

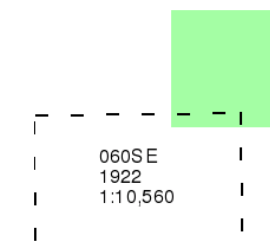

Historical Map - Slice D

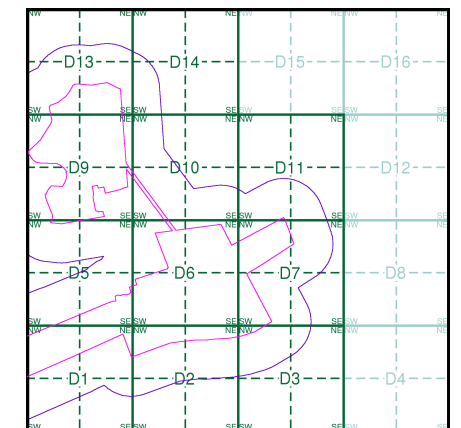

Order Details

Order Number: 298001007_1_1
 Customer Ref: 21-1098.04
 National Grid Reference: 491280, 377900
 Slice: D
 Site Area (Ha): 471.82
 Search Buffer (m): 250

Site Details

West Barton 1

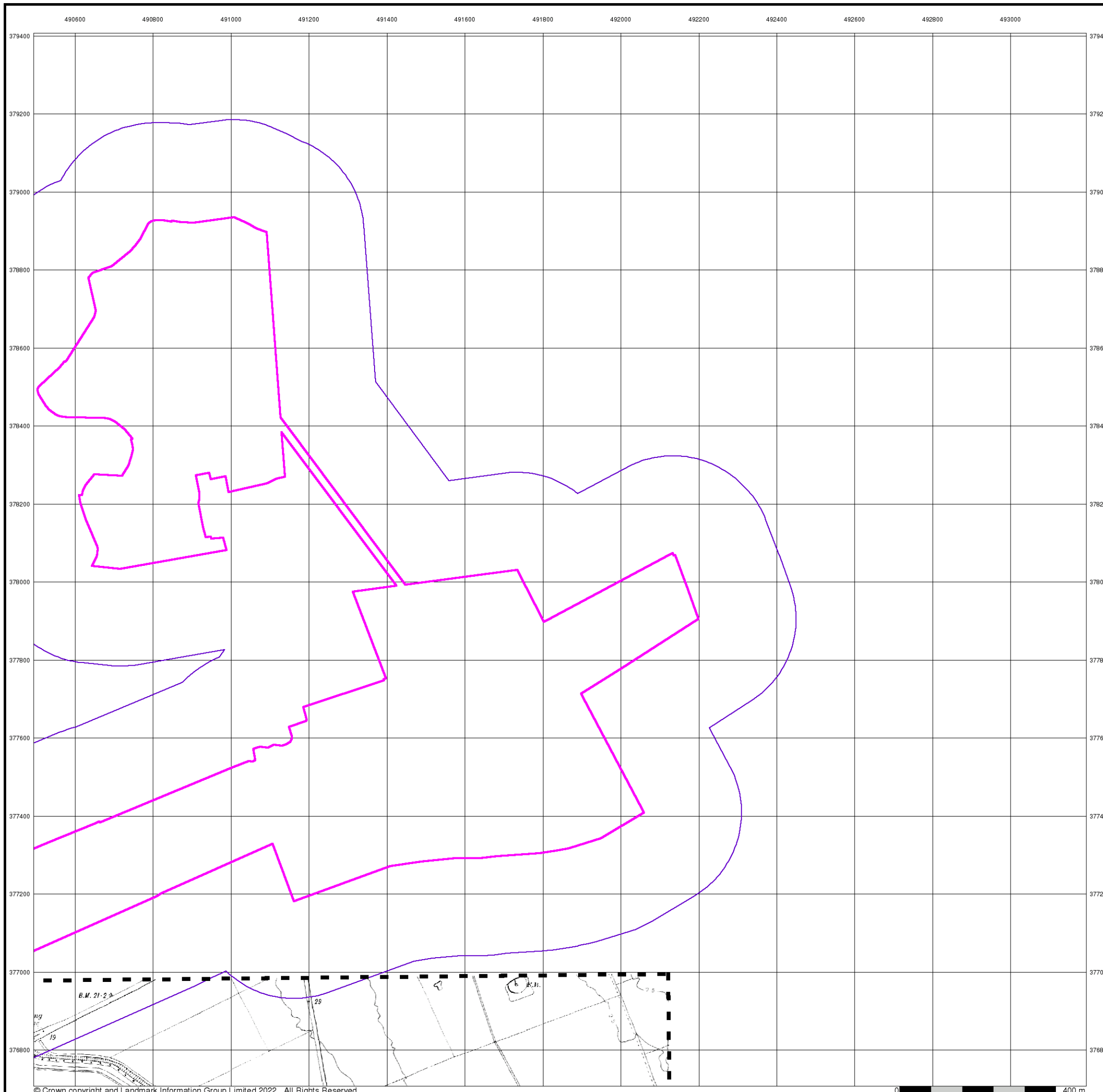

Lincolnshire

Published 1922

Source map scale - 1:10,560

The historical maps shown were reproduced from maps predominantly held at the scale adopted for England, Wales and Scotland in the 1840's. In 1854 the 1:2,500 scale was adopted for mapping urban areas; these maps were used to update the 1:10,560 maps. The published date given therefore is often some years later than the surveyed date. Before 1938, all OS maps were based on the Cassini Projection, with independent surveys of a single county or group of counties, giving rise to significant inaccuracies in outlying areas. In the late 1940's, a Provisional Edition was produced, which updated the 1:10,560 mapping from a number of sources. The maps appear unfinished - with all military camps and other strategic sites removed. These maps were initially overprinted with the National Grid. In 1970, the first 1:10,000 maps were produced using the Transverse Mercator Projection. The revision process continued until recently, with new editions appearing every 10 years or so for urban areas.

Map Name(s) and Date(s)

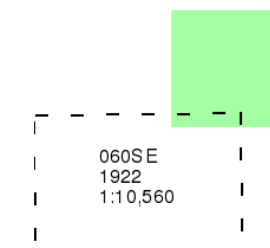

Historical Map - Slice D

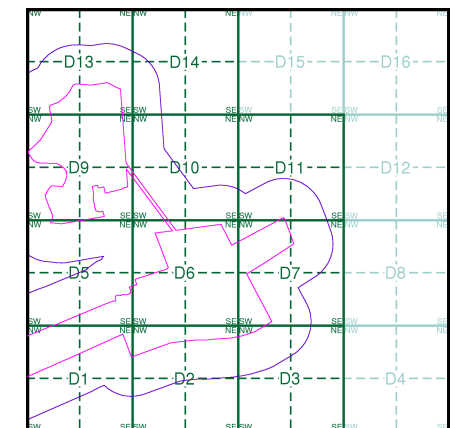

Order Details

Order Number: 298001007_1_1
 Customer Ref: 21-1098.04
 National Grid Reference: 491280, 377900
 Slice: D
 Site Area (Ha): 471.82
 Search Buffer (m): 250

Site Details

West Barton 1

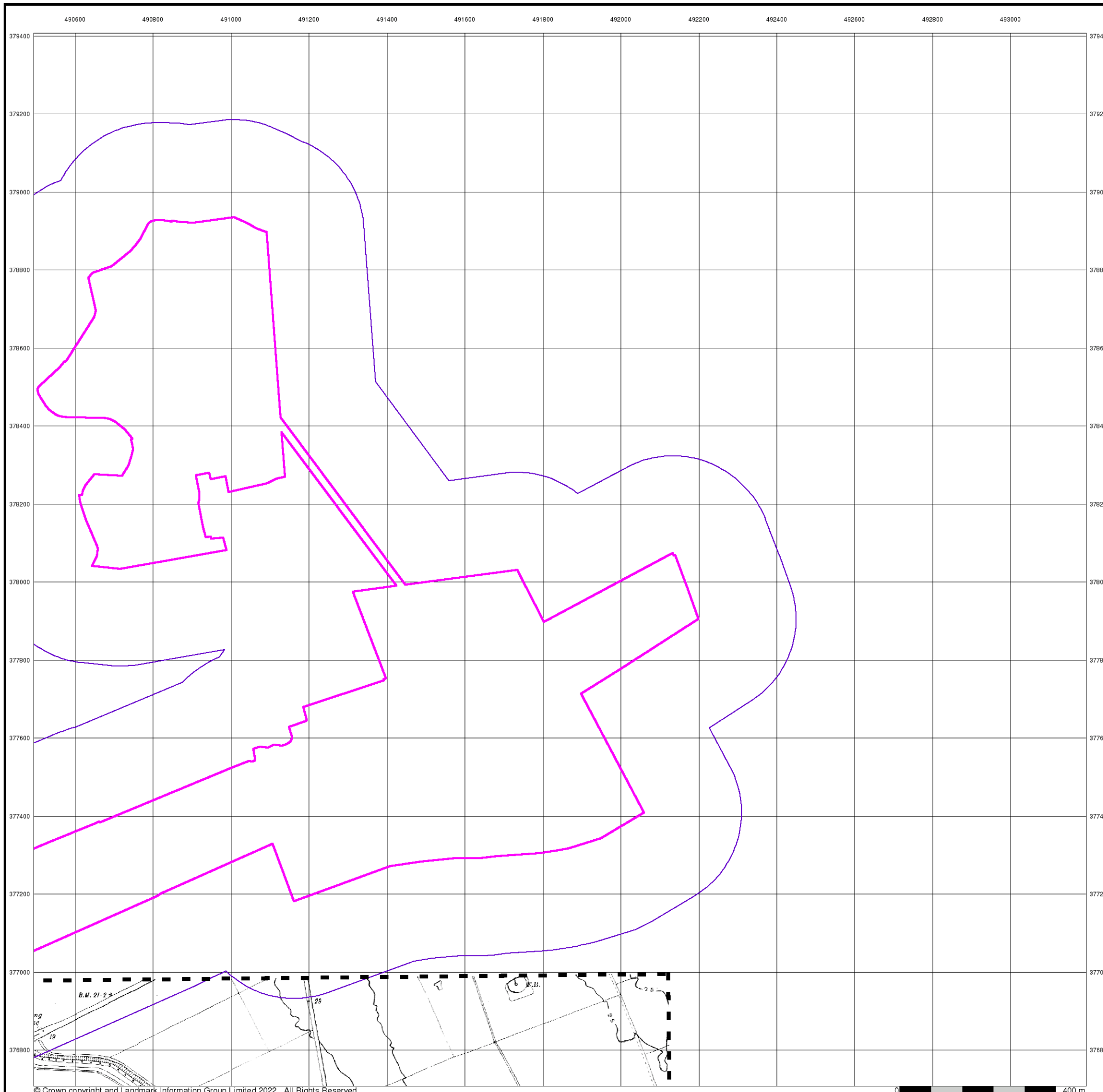

Lincolnshire

Published 1938 - 1950

Source map scale - 1:10,560

The historical maps shown were reproduced from maps predominantly held at the scale adopted for England, Wales and Scotland in the 1840's. In 1854 the 1:2,500 scale was adopted for mapping urban areas; these maps were used to update the 1:10,560 maps. The published date given therefore is often some years later than the surveyed date. Before 1938, all OS maps were based on the Cassini Projection, with independent surveys of a single county or group of counties, giving rise to significant inaccuracies in outlying areas. In the late 1940's, a Provisional Edition was produced, which updated the 1:10,560 mapping from a number of sources. The maps appear unfinished - with all military camps and other strategic sites removed. These maps were initially overprinted with the National Grid. In 1970, the first 1:10,000 maps were produced using the Transverse Mercator Projection. The revision process continued until recently, with new editions appearing every 10 years or so for urban areas.

Map Name(s) and Date(s)

060NE 1947 1:10,560	061NW 1947 1:10,560
060SE 1938 1:10,560	061SW 1950 1:10,560

Historical Map - Slice D

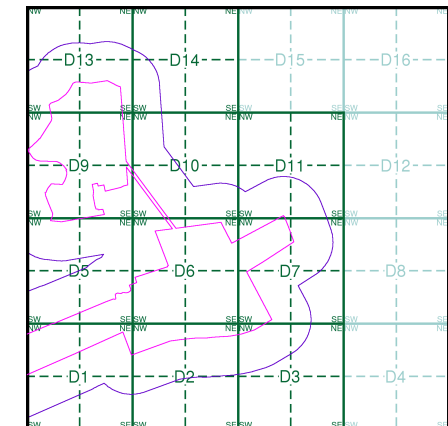

Order Details

Order Number: 298001007_1_1
 Customer Ref: 21-1098.04
 National Grid Reference: 491280, 377900
 Slice: D
 Site Area (Ha): 471.82
 Search Buffer (m): 250

Site Details

West Barton 1

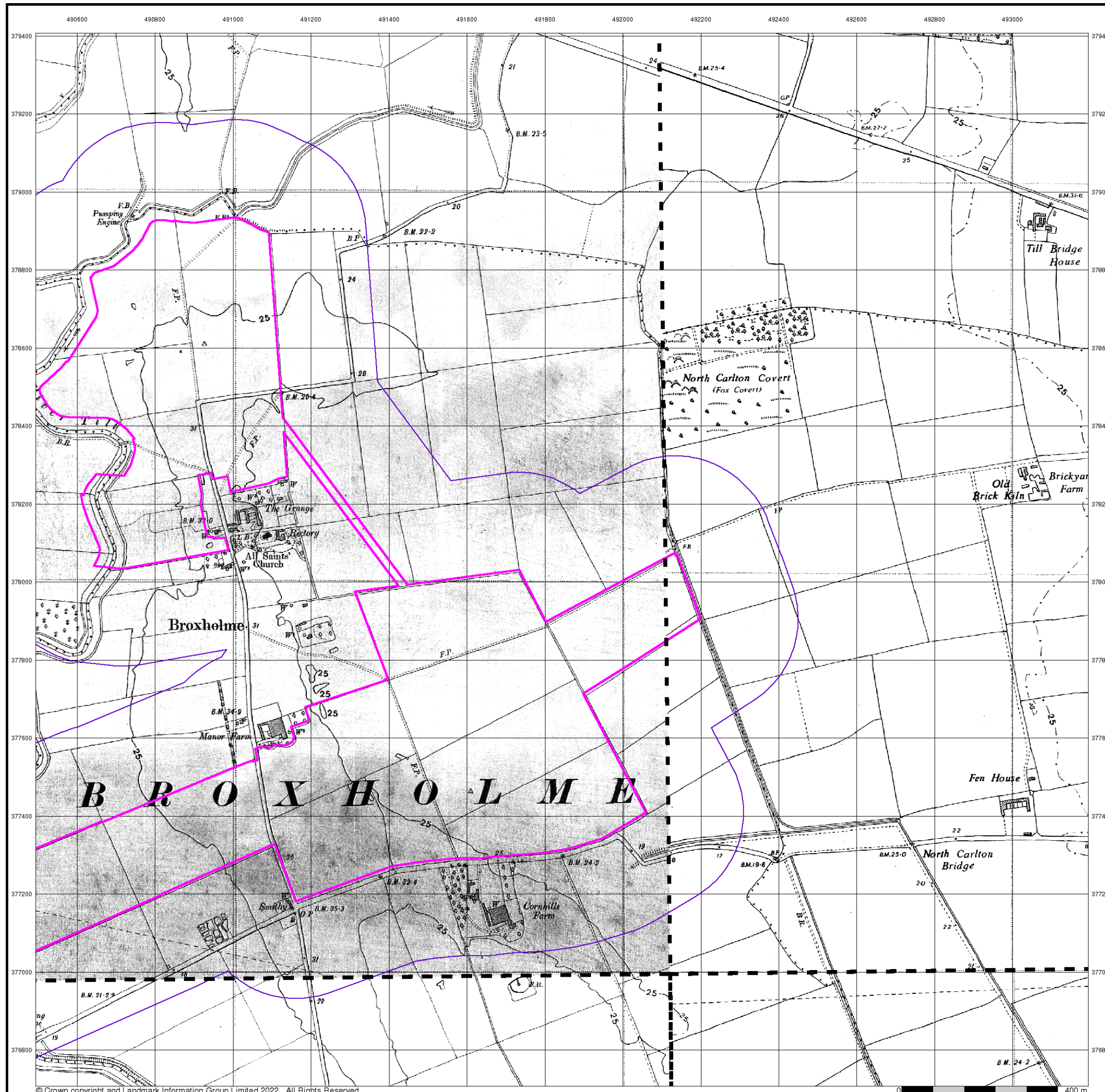

Lincolnshire

Published 1950

Source map scale - 1:10,560

The historical maps shown were reproduced from maps predominantly held at the scale adopted for England, Wales and Scotland in the 1840's. In 1854 the 1:2,500 scale was adopted for mapping urban areas; these maps were used to update the 1:10,560 maps. The published date given therefore is often some years later than the surveyed date. Before 1938, all OS maps were based on the Cassini Projection, with independent surveys of a single county or group of counties, giving rise to significant inaccuracies in outlying areas. In the late 1940's, a Provisional Edition was produced, which updated the 1:10,560 mapping from a number of sources. The maps appear unfinished - with all military camps and other strategic sites removed. These maps were initially overprinted with the National Grid. In 1970, the first 1:10,000 maps were produced using the Transverse Mercator Projection. The revision process continued until recently, with new editions appearing every 10 years or so for urban areas.

Map Name(s) and Date(s)

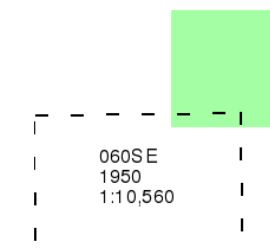

Historical Map - Slice D

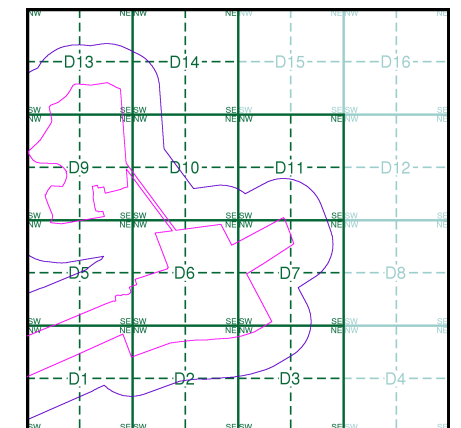

Order Details

Order Number: 298001007_1_1
 Customer Ref: 21-1098.04
 National Grid Reference: 491280, 377900
 Slice: D
 Site Area (Ha): 471.82
 Search Buffer (m): 250

Site Details

West Barton 1

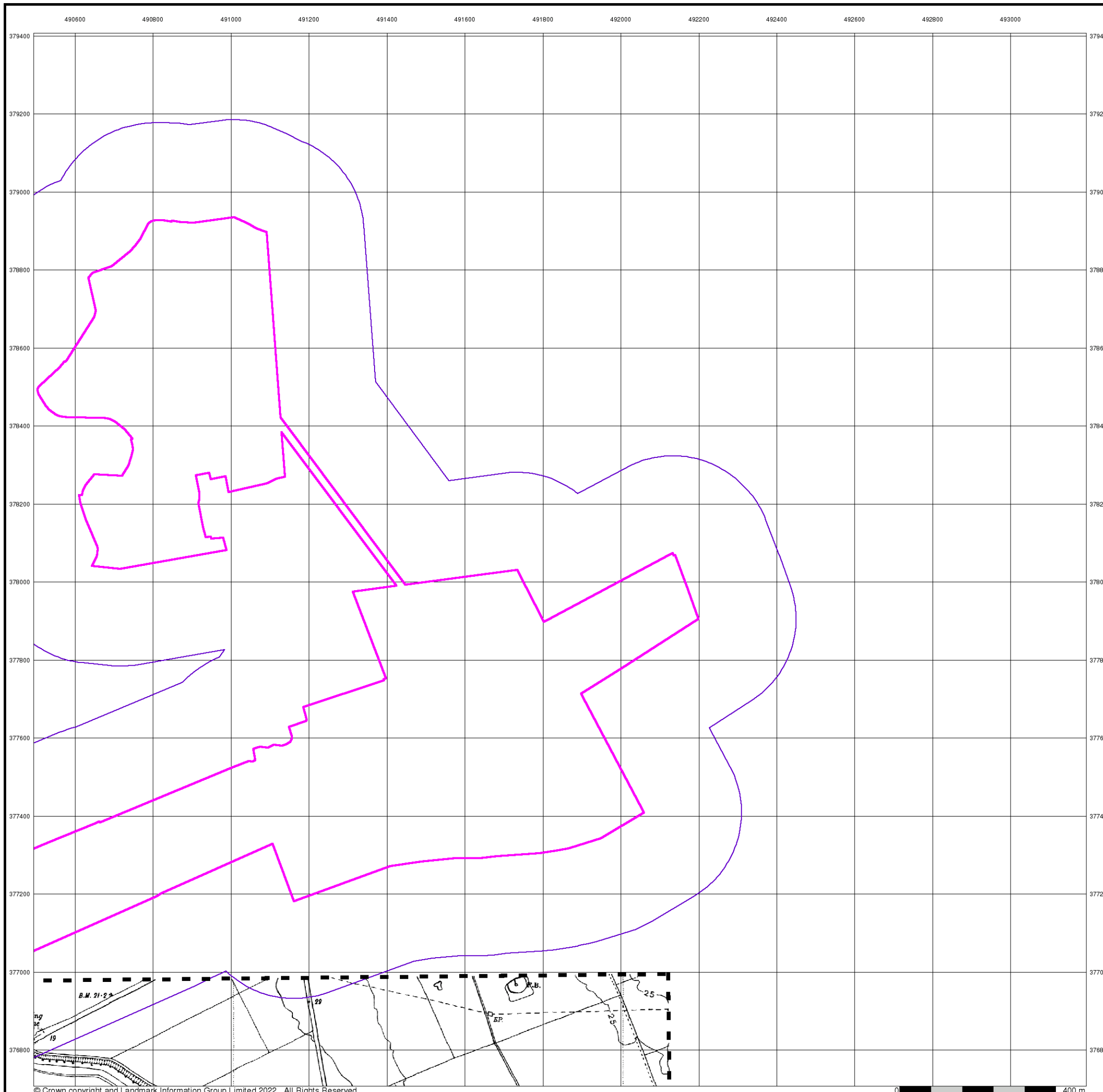

Ordnance Survey Plan

Published 1956

Source map scale - 1:10,000

The historical maps shown were reproduced from maps predominantly held at the scale adopted for England, Wales and Scotland in the 1840's. In 1854 the 1:2,500 scale was adopted for mapping urban areas; these maps were used to update the 1:10,560 maps. The published date given therefore is often some years later than the surveyed date. Before 1938, all OS maps were based on the Cassini Projection, with independent surveys of a single county or group of counties, giving rise to significant inaccuracies in outlying areas. In the late 1940's, a Provisional Edition was produced, which updated the 1:10,560 mapping from a number of sources. The maps appear unfinished - with all military camps and other strategic sites removed. These maps were initially overprinted with the National Grid. In 1970, the first 1:10,000 maps were produced using the Transverse Mercator Projection. The revision process continued until recently, with new editions appearing every 10 years or so for urban areas.

Map Name(s) and Date(s)

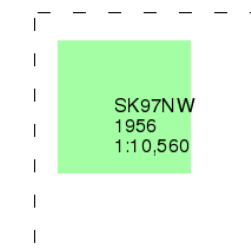

Historical Map - Slice D

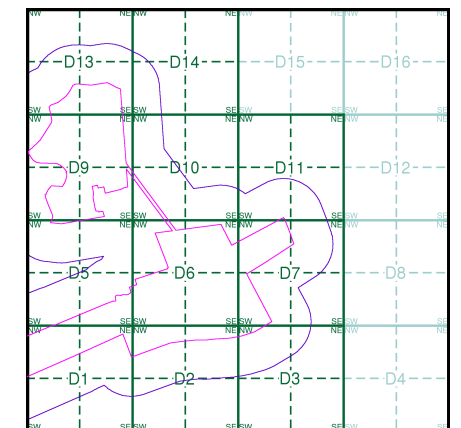

Order Details

Order Number: 298001007_1_1
 Customer Ref: 21-1098.04
 National Grid Reference: 491280, 377900
 Slice: D
 Site Area (Ha): 471.82
 Search Buffer (m): 250

Site Details

West Barton 1

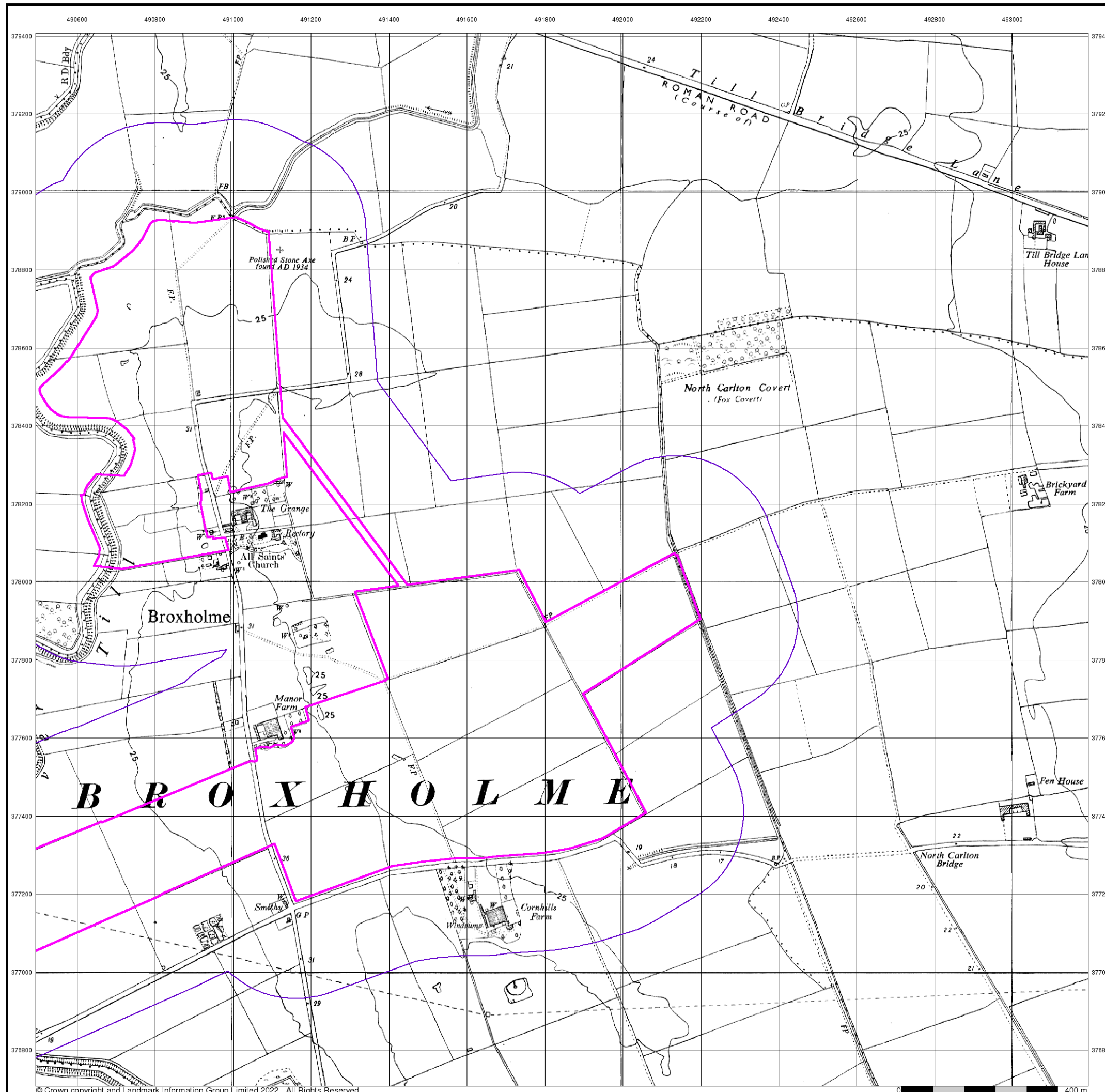

Ordnance Survey Plan

Published 1976

Source map scale - 1:10,000

The historical maps shown were reproduced from maps predominantly held at the scale adopted for England, Wales and Scotland in the 1840's. In 1854 the 1:2,500 scale was adopted for mapping urban areas; these maps were used to update the 1:10,560 maps. The published date given therefore is often some years later than the surveyed date. Before 1938, all OS maps were based on the Cassini Projection, with independent surveys of a single county or group of counties, giving rise to significant inaccuracies in outlying areas. In the late 1940's, a Provisional Edition was produced, which updated the 1:10,560 mapping from a number of sources. The maps appear unfinished - with all military camps and other strategic sites removed. These maps were initially overprinted with the National Grid. In 1970, the first 1:10,000 maps were produced using the Transverse Mercator Projection. The revision process continued until recently, with new editions appearing every 10 years or so for urban areas.

Map Name(s) and Date(s)

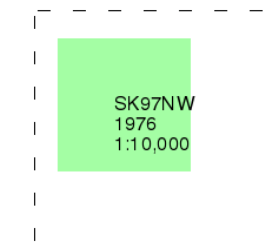

Historical Map - Slice D

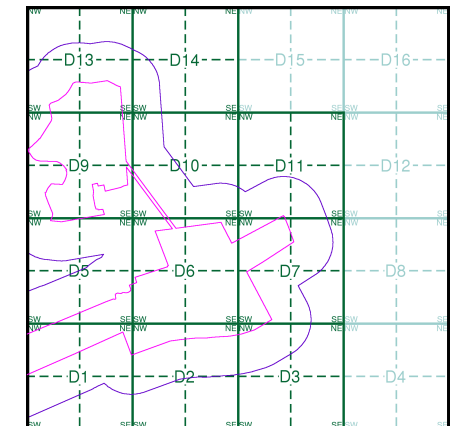

Order Details

Order Number: 298001007_1_1
 Customer Ref: 21-1098.04
 National Grid Reference: 491280, 377900
 Slice: D
 Site Area (Ha): 471.82
 Search Buffer (m): 250

Site Details

West Barton 1

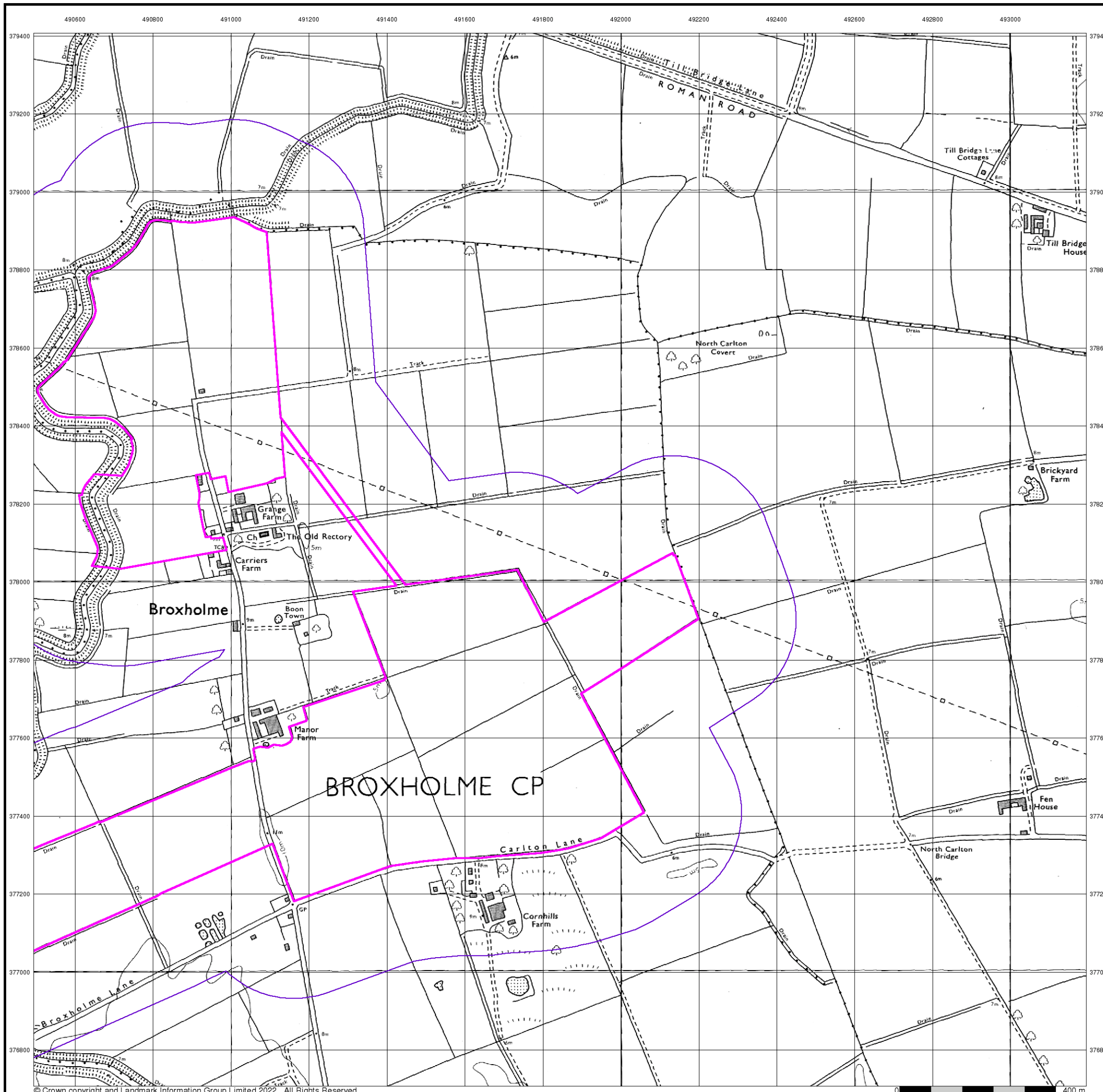

10k Raster Mapping

Published 2000

Source map scale - 1:10,000

The historical maps shown were produced from the Ordnance Survey's 1:10,000 colour raster mapping. These maps are derived from Landplan which replaced the old 1:10,000 maps originally published in 1970. The data is highly detailed showing buildings, fences and field boundaries as well as all roads, tracks and paths. Road names are also included together with the relevant road number and classification. Boundary information depiction includes county, unitary authority, district, civil parish and constituency.

Map Name(s) and Date(s)

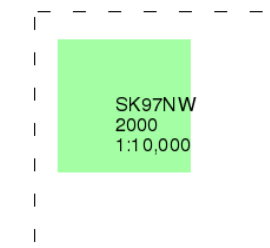

Historical Map - Slice D

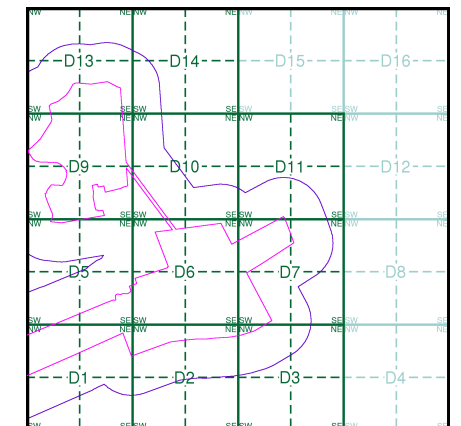

Order Details

Order Number: 298001007_1_1
 Customer Ref: 21-1098.04
 National Grid Reference: 491280, 377900
 Slice: D
 Site Area (Ha): 471.82
 Search Buffer (m): 250

Site Details

West Barton 1

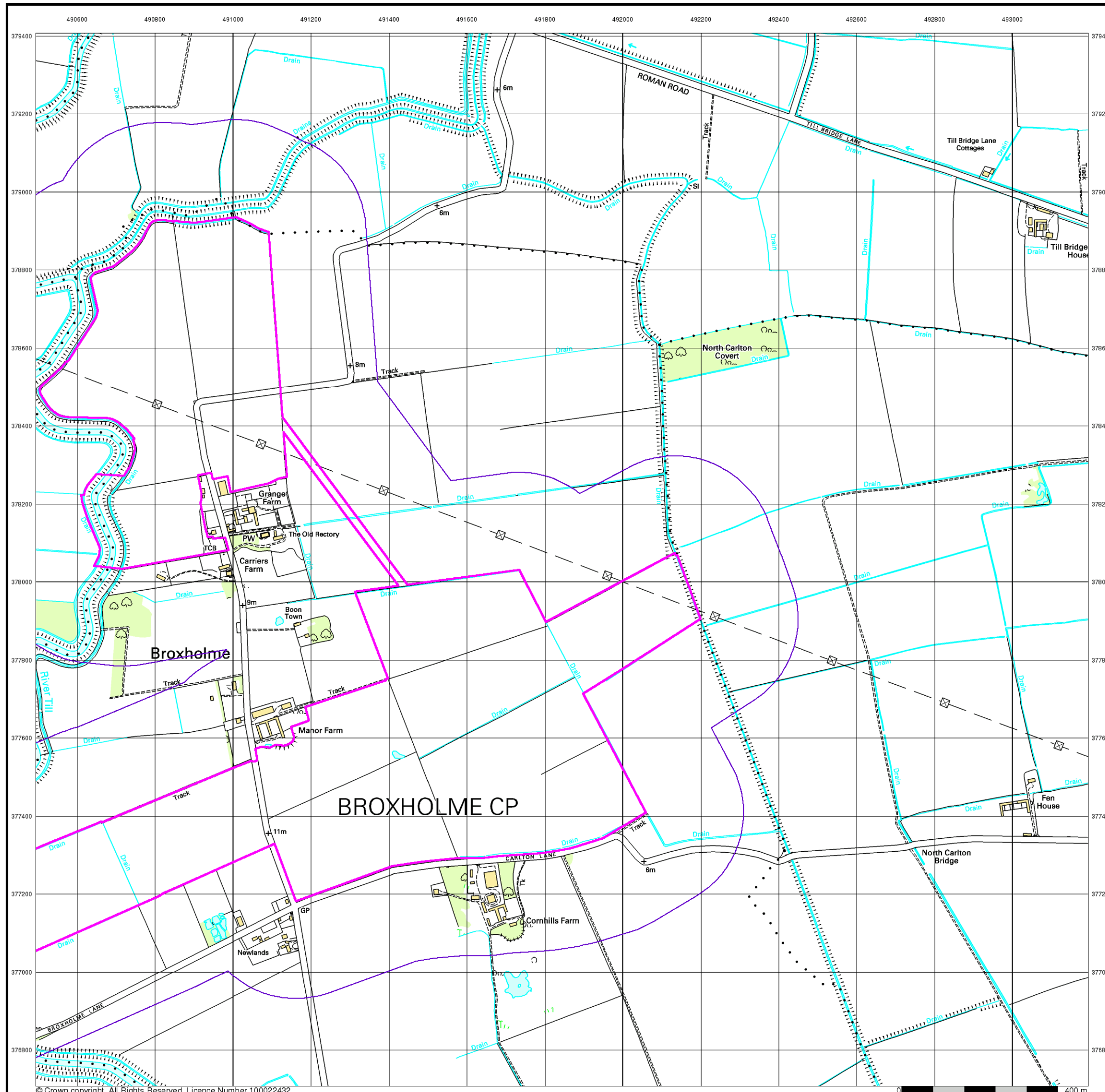

© Crown copyright. All Rights Reserved. Licence Number 100022432.

Street View

Published 2022

Source map scale - 1:10,000

Street View is a street-level map for the whole of Great Britain produced by the Ordnance Survey. These maps are provided at a nominal scale of 1:10,000

Map Name(s) and Date(s)



Street View Map - Slice D

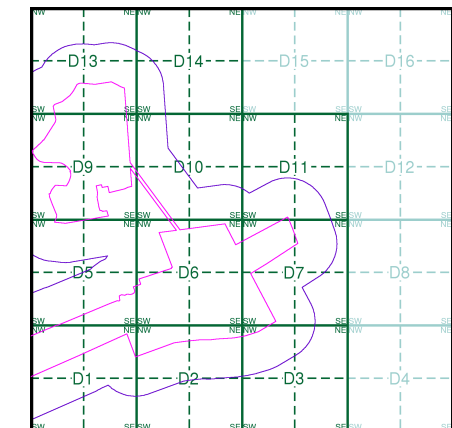

Order Details

Order Number: 298001007_1_1
 Customer Ref: 21-1098.04
 National Grid Reference: 491280, 377900
 Slice: D
 Site Area (Ha): 471.82
 Search Buffer (m): 250

Site Details

West Barton 1

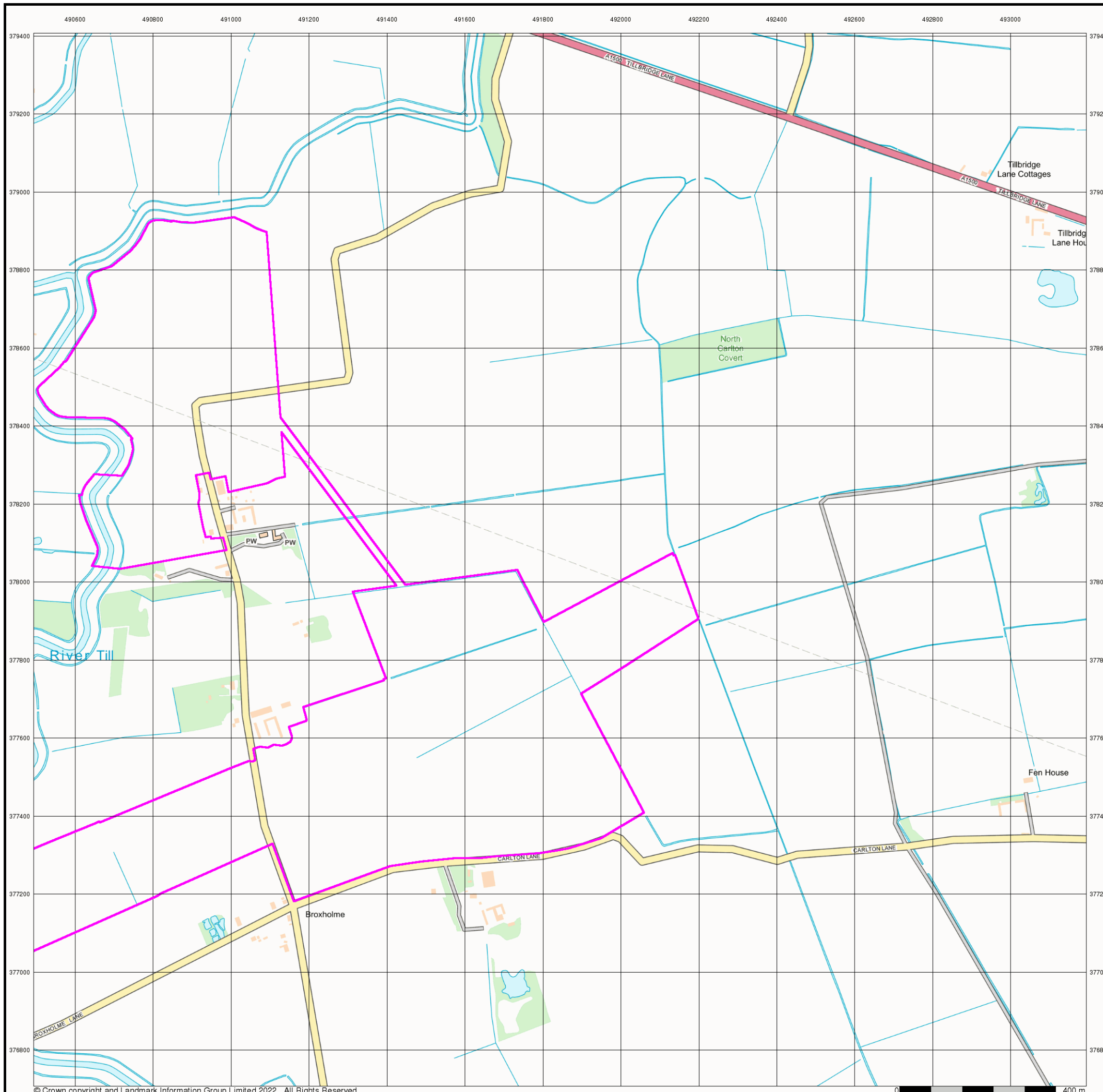

Historical Mapping Legends

Ordnance Survey County Series and Ordnance Survey Plan 1:2,500

Quarry **Gravel Pit** **Sand Pit**
Clay Pit **Shingle** **Refuse Heap**
Sloping Masonry **Flat Rock**
Marsh **Reeds** **Osiers**
Rough Pasture **Furze** **Wood**
Mixed Wood **Brushwood** **Orchard**
Fir **Ford** **Stepping Stones**
Ferry **Waterfall** **Lock**
Trig. Station **Altitude at Trig. Station**
B.M. 325.9 **Bench Mark** **Surface Level**
Arrow denotes flow of water **Antiquities (site of)**
Cutting **Embankment**
Railway crossing Road **Level Crossing** **Road crossing Railway**
Railway crossing River or Canal **Road over single stream** **Road over River or Canal**
County Boundary (Geographical)
County & Civil Parish Boundary
Administrative County & Civil Parish Boundary
County Borough Boundary (England)
Co. Boro. Bdy.
County Burgh Boundary (Scotland)
Co. Burgh Bdy.
BP BS Boundary Post or Stone **P.C.B** Police Call Box
B.R. Bridle Road **P** Pump
E.P Electricity Pylon **S.P** Signal Post
F.B. Foot Bridge **SL** Sluice
F.P. Foot Path **Sp.** Spring
G.P Guide Post or Board **T.C.B** Telephone Call Box
M.S Mile Stone **Tr.** Trough
M.P M.R Mooring Post or Ring **W** Well

Ordnance Survey Plan, Additional SIMs and Supply of Unpublished Survey Information 1:2,500 and 1:1,250

Inactive Quarry, Chalk Pit or Clay Pit **Active Quarry, Chalk Pit or Clay Pit**
Rock **Boulders**
Cliff **Slopes** **Top**
Roofed Building **Glazed Roof Building**
Sloping Masonry **Archway**
Non-Coniferous Tree (surveyed) **Coniferous Tree (surveyed)**
Non-Coniferous Trees (not surveyed) **Coniferous Trees (not surveyed)**
Orchard Tree **Scrub** **Bracken**
Coppice, Osier **Reeds** **Marsh, Saltings**
Rough Grassland **Heath** **Culvert**
Direction of water flow **Bench Mark** **Antiquity (site of)**
Cave Entrance **Triangulation Station** **Electricity Pylon**
Electricity Transmission Line
County Boundary (Geographical)
County & Civil Parish Boundary
Civil Parish Boundary
Admin. County or County Bor. Boundary
L B Bdy London Borough Boundary
Symbol marking point where boundary mereing changes
BH Beer House **P** Pillar, Pole or Post
BP, BS Boundary Post or Stone **PO** Post Office
Cn, C Capstan, Crane **PC** Public Convenience
Chy Chimney **PH** Public House
D Fn Drinking Fountain **Pp** Pump
EI P Electricity Pillar or Post **SB, S Br** Signal Box or Bridge
FAP Fire Alarm Pillar **SP, SL** Signal Post or Light
FB Foot Bridge **Spr** Spring
GP Guide Post **Tk** Tank or Track
H Hydrant or Hydraulic **TCB** Telephone Call Box
LC Level Crossing **TCP** Telephone Call Post
MH Manhole **Tr** Trough
MP Mile Post or Mooring Post **Wr Pt, Wr T** Water Point, Water Tap
MS Mile Stone **W** Well
NTL Normal Tidal Limit **Wd Pp** Wind Pump

Large-Scale National Grid Data 1:2,500 and 1:1,250

Cliff **Slopes** **Top**
Rock **Rock (scattered)**
Boulders **Boulders (scattered)**
Positioned Boulder **Scree**
Non-Coniferous Tree (surveyed) **Coniferous Tree (surveyed)**
Non-Coniferous Trees (not surveyed) **Coniferous Trees (not surveyed)**
Orchard Tree **Scrub** **Bracken**
Coppice, Osier **Reeds** **Marsh, Saltings**
Rough Grassland **Heath** **Culvert**
Direction of water flow **Triangulation Station** **Antiquity (site of)**
Electricity Transmission Line **Electricity Pylon**
BM 231.60m Bench Mark **Buildings with Building Seed**
Roofed Building **Glazed Roof Building**
Civil parish/community boundary
District boundary
County boundary
Boundary post/stone
Boundary mereing symbol (note: these always appear in opposed pairs or groups of three)
Bks Barracks **P** Pillar, Pole or Post
Bty Battery **PO** Post Office
Cemy Cemetery **PC** Public Convenience
Chy Chimney **Pp** Pump
Cis Cistern **Ppg Sta** Pumping Station
Dismtd Rly Dismantled Railway **PW** Place of Worship
EI Gen Sta Electricity Generating Station **Sewage Ppg Sta** Sewage Pumping Station
EI P Electricity Pole, Pillar **SB, S Br** Signal Box or Bridge
EI Sub Sta Electricity Sub Station **SP, SL** Signal Post or Light
FB Filter Bed **Spr** Spring
Fn / D Fn Fountain / Drinking Ftn. **Tk** Tank or Track
Gas Gov Gas Valve Compound **Tr** Trough
GVC Gas Governor **Wd Pp** Wind Pump
GP Guide Post **Wr Pt, Wr T** Water Point, Water Tap
MH Manhole **Wks** Works (building or area)
MP, MS Mile Post or Mile Stone **W** Well

Historical Mapping & Photography included:

Mapping Type	Scale	Date	Pg
Lincolnshire	1:2,500	1886	2
Lincolnshire	1:2,500	1906	3
Lincolnshire	1:2,500	1920	4
Ordnance Survey Plan	1:2,500	1973 - 1974	5
Additional SIMs	1:2,500	1993	6
Large-Scale National Grid Data	1:2,500	1994	7

Historical Map - Segment D1

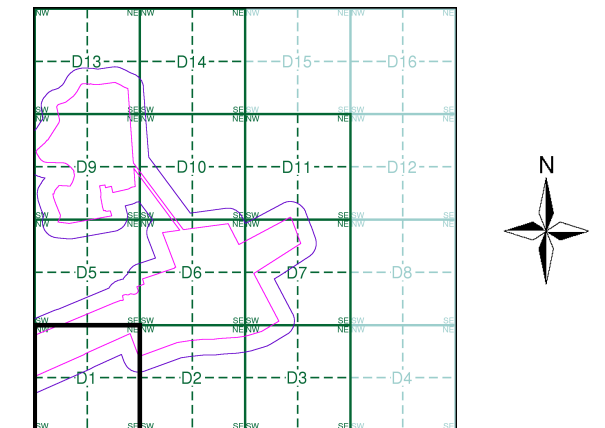

Order Details

Order Number: 298001007_1_1
 Customer Ref: 21-1098.04
 National Grid Reference: 491280, 377900
 Slice: D
 Site Area (Ha): 471.82
 Search Buffer (m): 100

Site Details

West Barton 1

Lincolnshire

Published 1886

Source map scale - 1:2,500

The historical maps shown were reproduced from maps predominantly held at the scale adopted for England, Wales and Scotland in the 1840's. In 1854 the 1:2,500 scale was adopted for mapping urban areas and by 1896 it covered the whole of what were considered to be the cultivated parts of Great Britain. The published date given below is often some years later than the surveyed date. Before 1938, all OS maps were based on the Cassini Projection, with independent surveys of a single county or group of counties, giving rise to significant inaccuracies in outlying areas.

Map Name(s) and Date(s)

060_08	1886	1:2,500
060_12	1886	1:2,500

Historical Map - Segment D1

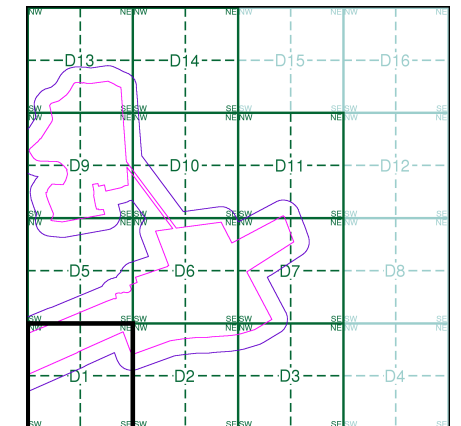

Order Details

Order Number: 298001007_1_1
 Customer Ref: 21-1098.04
 National Grid Reference: 491280, 377900
 Slice: D
 Site Area (Ha): 471.82
 Search Buffer (m): 100

Site Details

West Barton 1

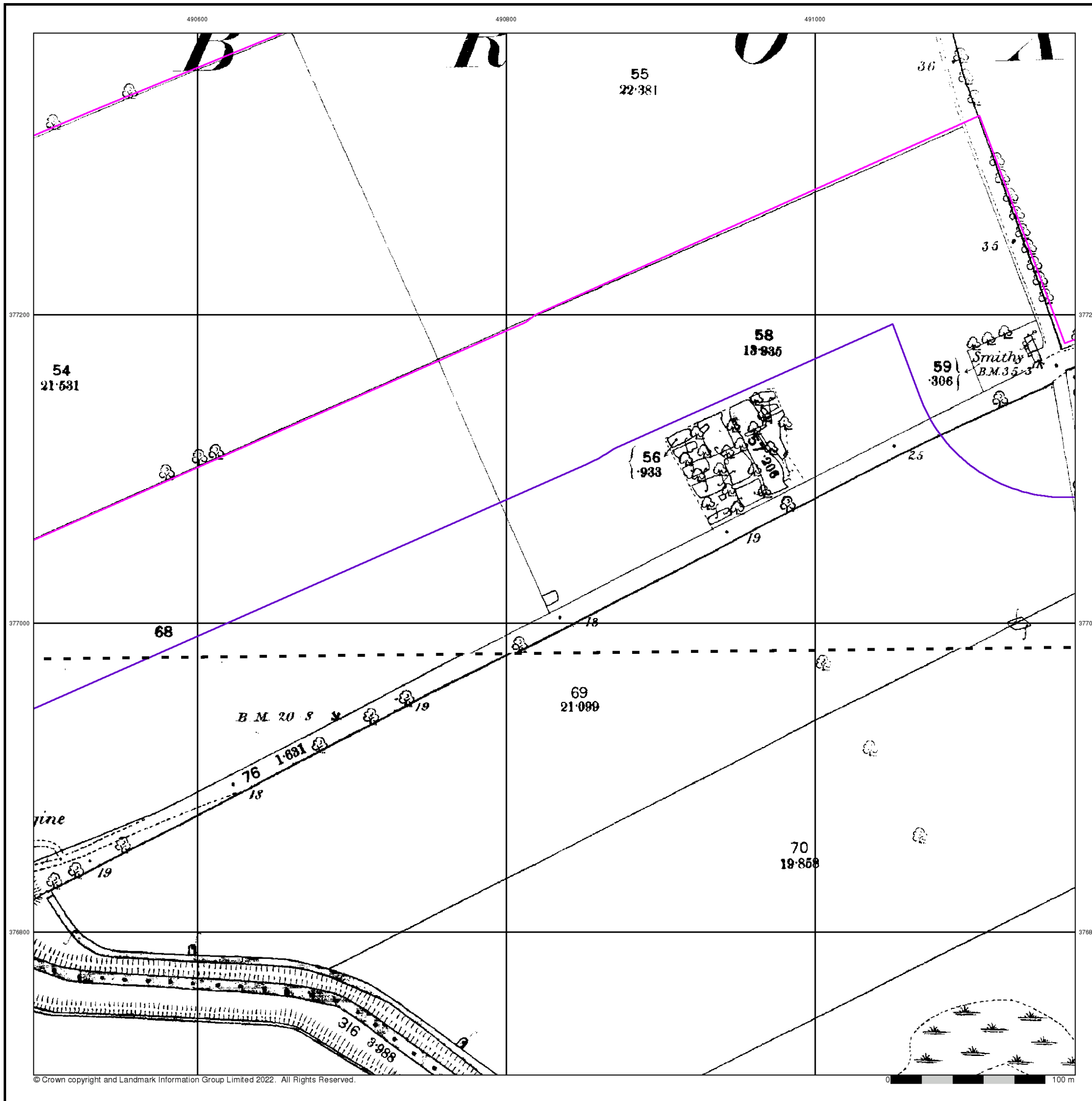

Lincolnshire

Published 1906

Source map scale - 1:2,500

The historical maps shown were reproduced from maps predominantly held at the scale adopted for England, Wales and Scotland in the 1840's. In 1854 the 1:2,500 scale was adopted for mapping urban areas and by 1896 it covered the whole of what were considered to be the cultivated parts of Great Britain. The published date given below is often some years later than the surveyed date. Before 1938, all OS maps were based on the Cassini Projection, with independent surveys of a single county or group of counties, giving rise to significant inaccuracies in outlying areas.

Map Name(s) and Date(s)

060_08	1906	1:2,500
060_12	1906	1:2,500

Historical Map - Segment D1

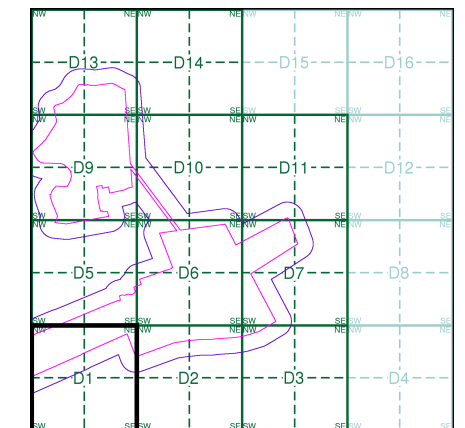

Order Details

Order Number: 298001007_1_1
 Customer Ref: 21-1098.04
 National Grid Reference: 491280, 377900
 Slice: D
 Site Area (Ha): 471.82
 Search Buffer (m): 100

Site Details

West Barton 1

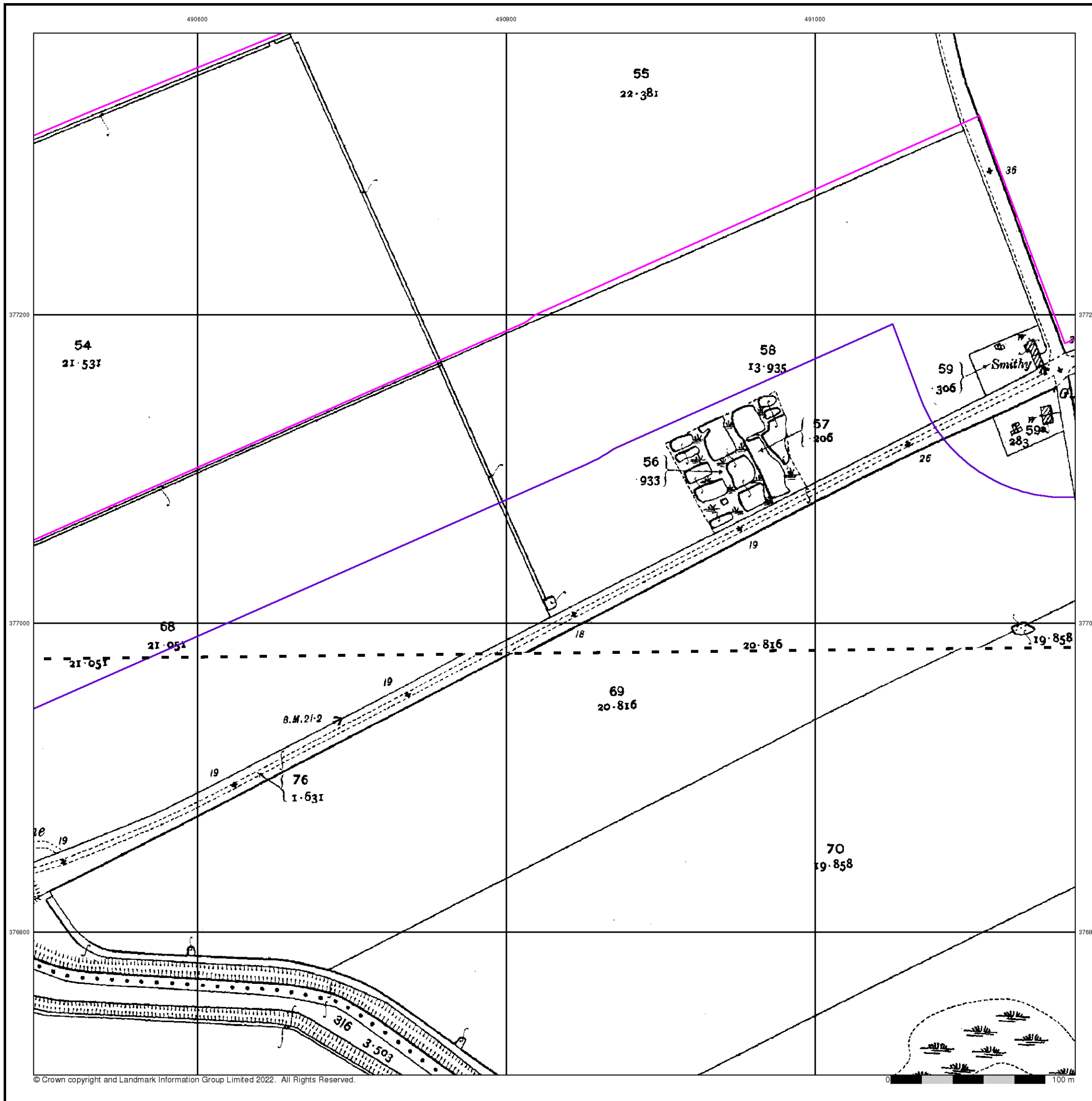

Lincolnshire

Published 1920

Source map scale - 1:2,500

The historical maps shown were reproduced from maps predominantly held at the scale adopted for England, Wales and Scotland in the 1840's. In 1854 the 1:2,500 scale was adopted for mapping urban areas and by 1896 it covered the whole of what were considered to be the cultivated parts of Great Britain. The published date given below is often some years later than the surveyed date. Before 1938, all OS maps were based on the Cassini Projection, with independent surveys of a single county or group of counties, giving rise to significant inaccuracies in outlying areas.

Map Name(s) and Date(s)

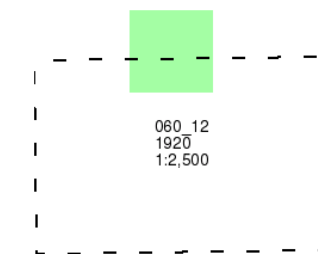

Historical Map - Segment D1

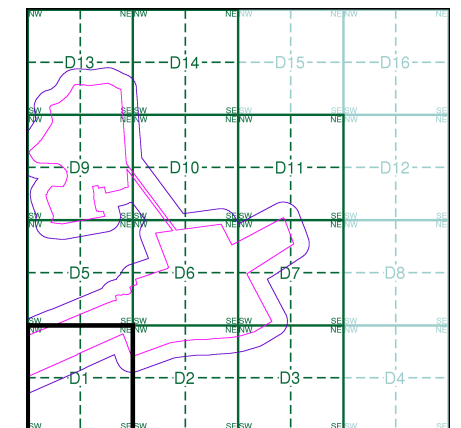

Order Details

Order Number: 298001007_1_1
 Customer Ref: 21-1098.04
 National Grid Reference: 491280, 377900
 Slice: D
 Site Area (Ha): 471.82
 Search Buffer (m): 100

Site Details

West Barton 1

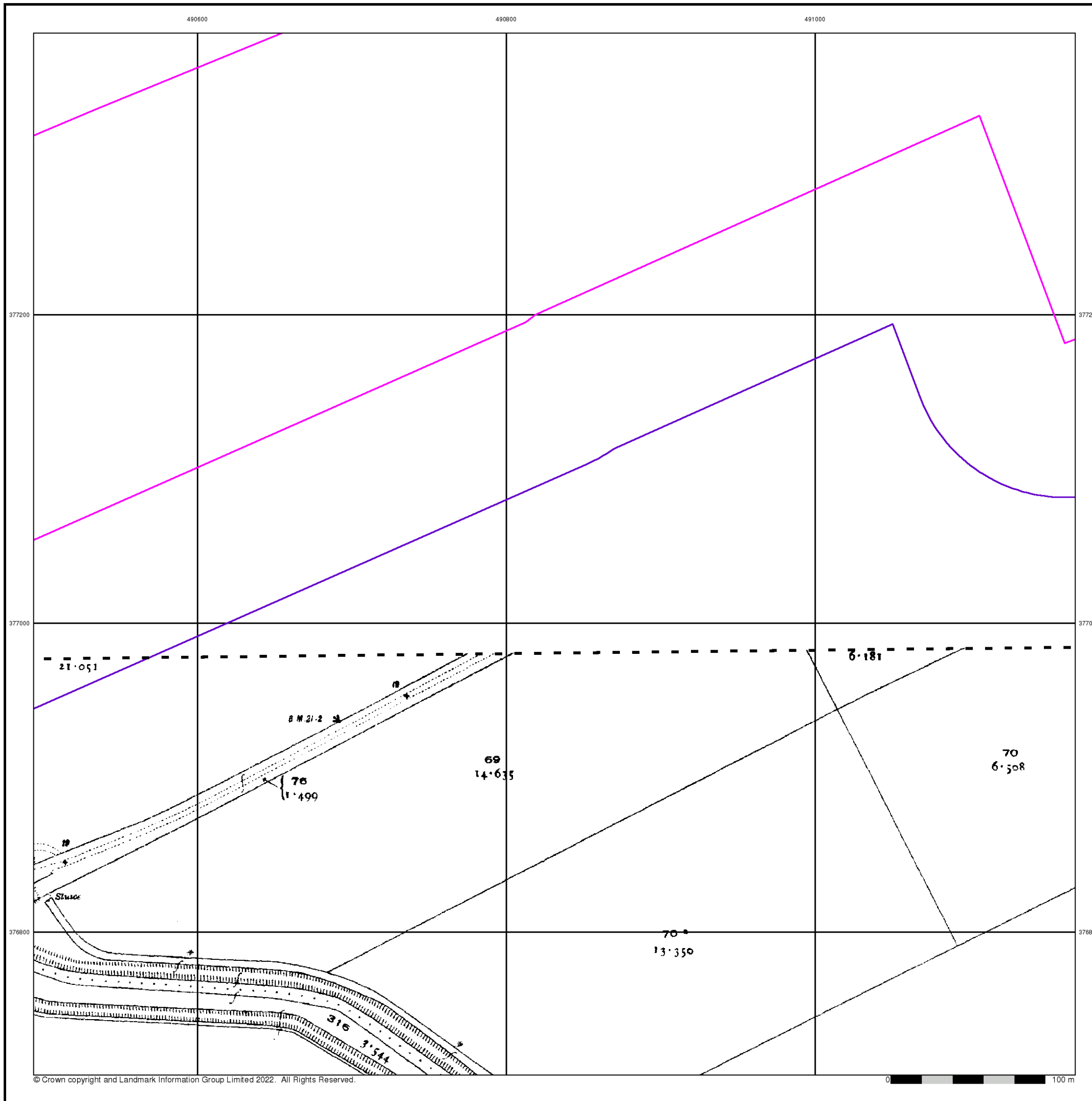

Ordnance Survey Plan
Published 1973 - 1974
Source map scale - 1:2,500

The historical maps shown were reproduced from maps predominantly held at the scale adopted for England, Wales and Scotland in the 1840's. In 1854 the 1:2,500 scale was adopted for mapping urban areas and by 1896 it covered the whole of what were considered to be the cultivated parts of Great Britain. The published date given below is often some years later than the surveyed date. Before 1938, all OS maps were based on the Cassini Projection, with independent surveys of a single county or group of counties, giving rise to significant inaccuracies in outlying areas.

Map Name(s) and Date(s)

SK9077 1974 1:2,500	SK9177 1974 1:2,500
SK9076 1973 1:2,500	SK9176 1973 1:2,500

Historical Map - Segment D1

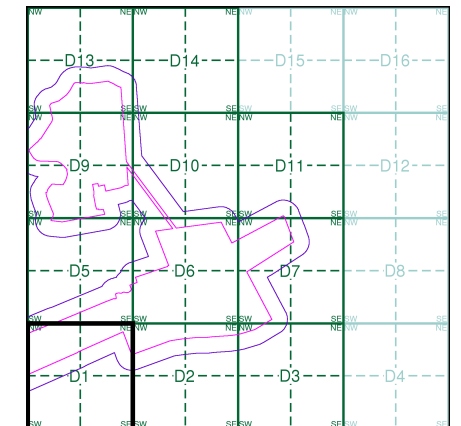

Order Details

Order Number: 298001007_1_1
 Customer Ref: 21-1098.04
 National Grid Reference: 491280, 377900
 Slice: D
 Site Area (Ha): 471.82
 Search Buffer (m): 100

Site Details

West Barton 1

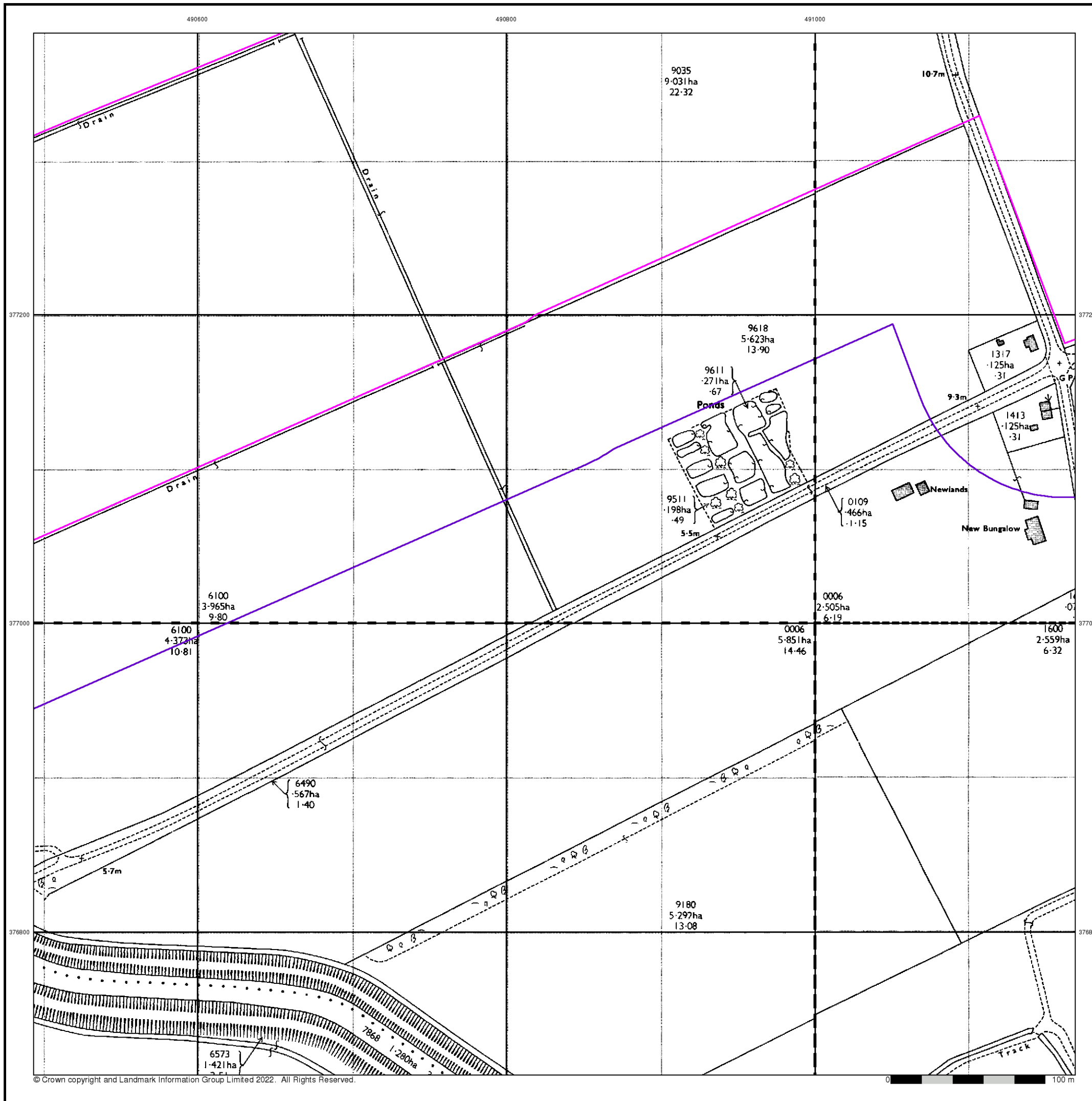

Additional SIMs

Published 1993

Source map scale - 1:2,500

The SIM cards (Ordnance Survey's 'Survey of Information on Microfilm') are further, minor editions of mapping which were produced and published in between the main editions as an area was updated. They date from 1947 to 1994, and contain detailed information on buildings, roads and land-use. These maps were produced at both 1:2,500 and 1:1,250 scales.

Map Name(s) and Date(s)

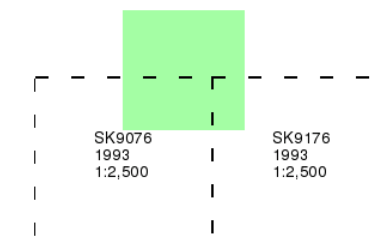

Historical Map - Segment D1

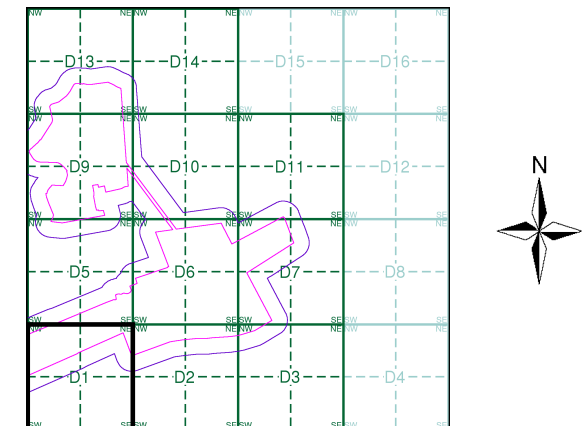

Order Details

Order Number: 298001007_1_1
 Customer Ref: 21-1098.04
 National Grid Reference: 491280, 377900
 Slice: D
 Site Area (Ha): 471.82
 Search Buffer (m): 100

Site Details

West Barton 1

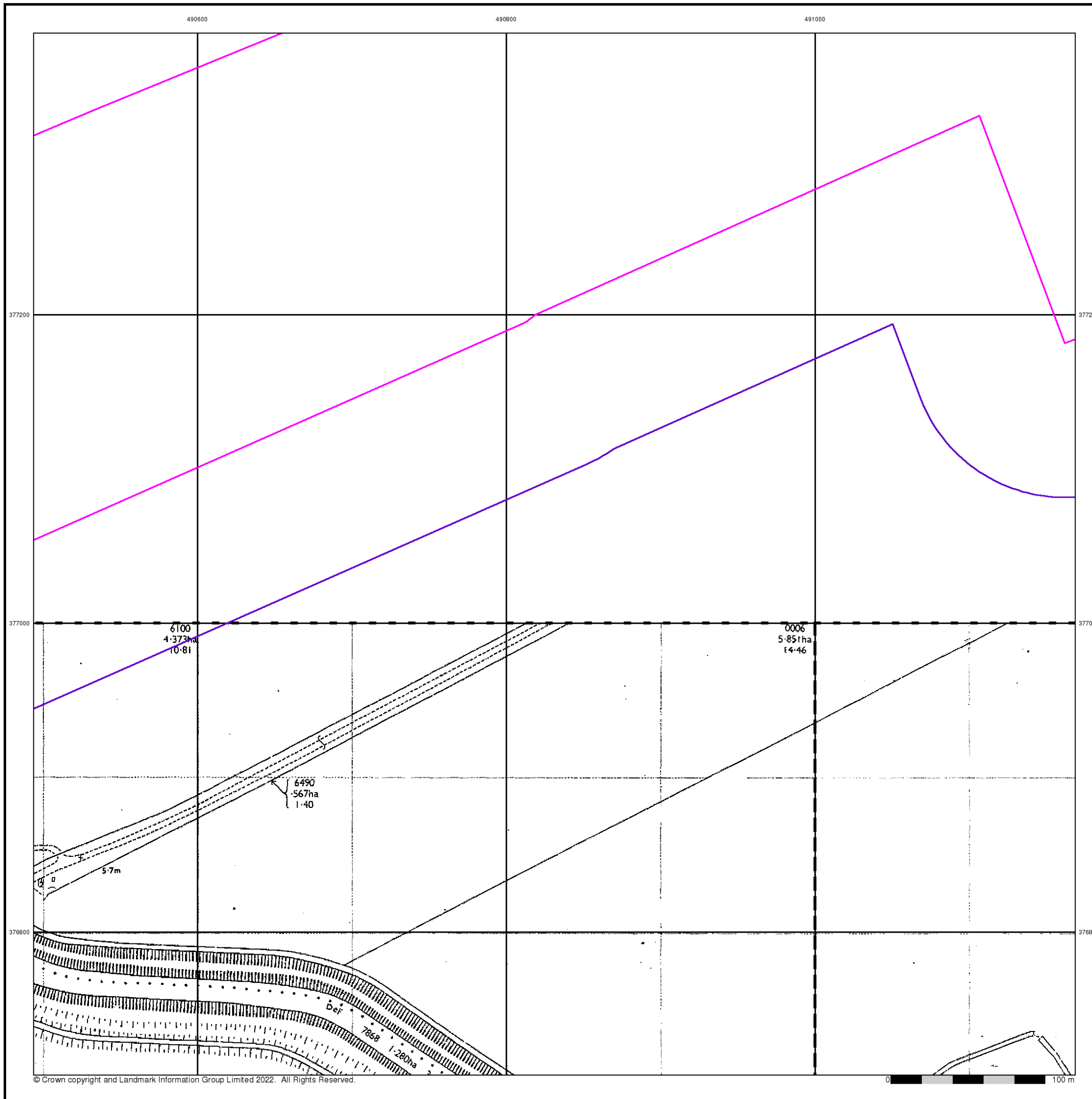

Large-Scale National Grid Data
Published 1994
Source map scale - 1:2,500

'Large Scale National Grid Data' superseded SIM cards (Ordnance Survey's 'Survey of Information on Microfilm') in 1992, and continued to be produced until 1999. These maps were the fore-runners of digital mapping and so provide detailed information on houses and roads, but tend to show less topographic features such as vegetation. These maps were produced at both 1:2,500 and 1:1,250 scales.

Map Name(s) and Date(s)

SK9077	SK9177
1994	1994
1:2,500	1:2,500
SK9076	SK9176
1994	1994
1:2,500	1:2,500

Historical Map - Segment D1

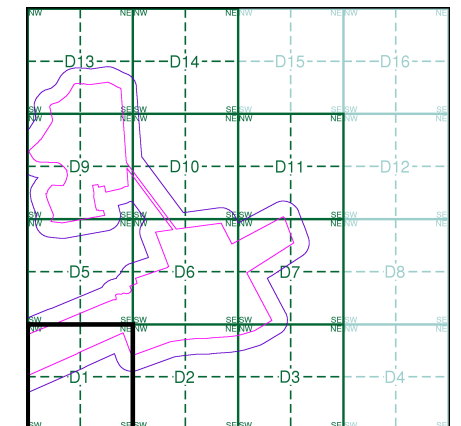

Order Details

Order Number: 298001007_1_1
 Customer Ref: 21-1098.04
 National Grid Reference: 491280, 377900
 Slice: D
 Site Area (Ha): 471.82
 Search Buffer (m): 100

Site Details

West Barton 1

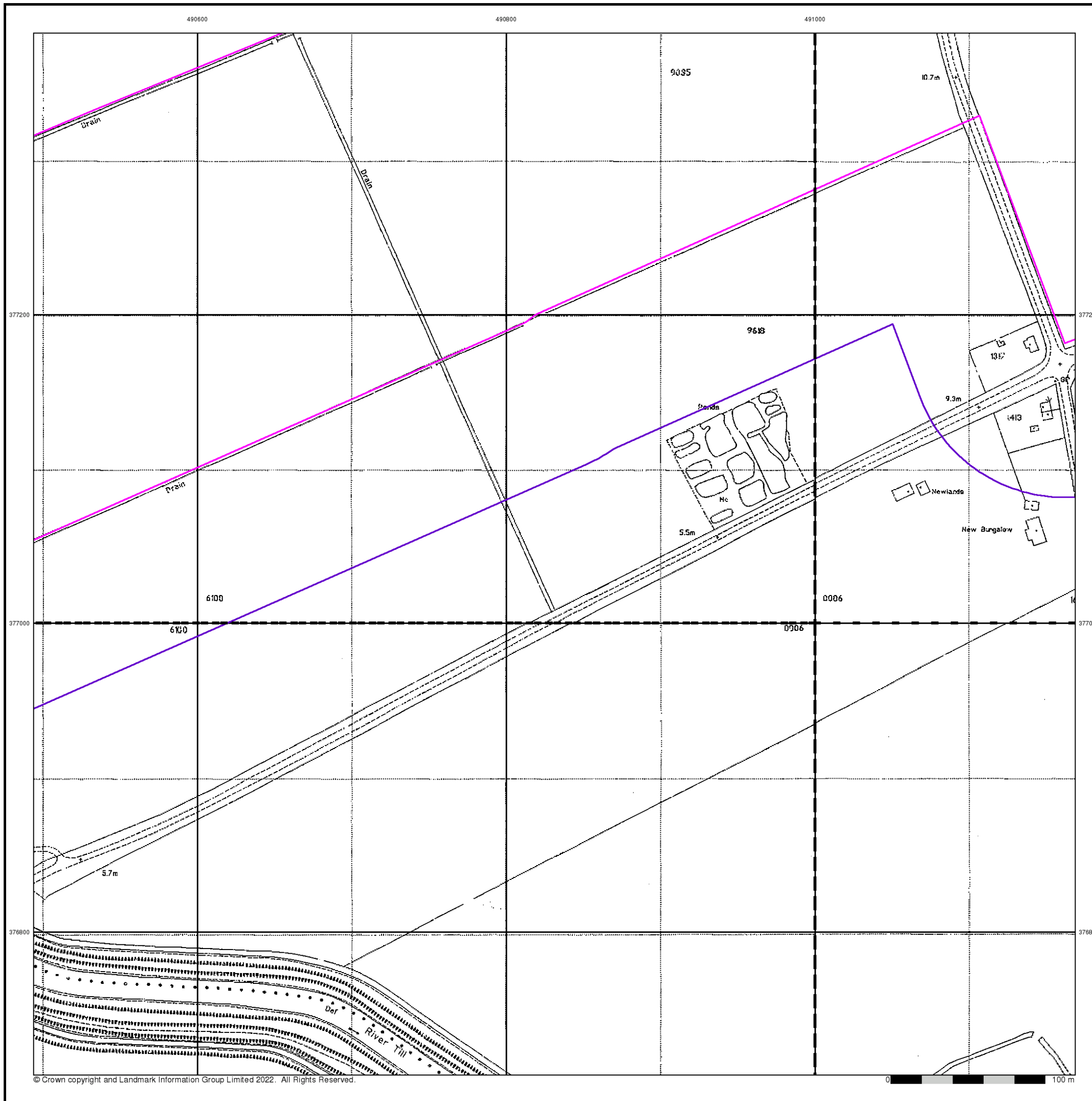

Historical Mapping Legends

Ordnance Survey County Series and Ordnance Survey Plan 1:2,500

Quarry **Gravel Pit** **Sand Pit**
Clay Pit **Shingle** **Refuse Heap**
Sloping Masonry **Flat Rock**
Marsh **Reeds** **Osiers**
Rough Pasture **Furze** **Wood**
Mixed Wood **Brushwood** **Orchard**
Fir **Ford** **Stepping Stones**
Ferry **Waterfall** **Lock**
Trig. Station **Altitude at Trig. Station**
B.M. 325.9 **Bench Mark** **Surface Level**
Arrow denotes flow of water **Antiquities (site of)**
Cutting **Embankment**
Railway crossing Road **Level Crossing** **Road crossing Railway**
Railway crossing River or Canal **Road over single stream** **Road over River or Canal**
County Boundary (Geographical)
County & Civil Parish Boundary
Administrative County & Civil Parish Boundary
County Borough Boundary (England)
County Burgh Boundary (Scotland)
Co. Boro. Bdy.
Co. Burgh Bdy.
Boundary Post or Stone **Police Call Box**
B.R. **Bridle Road** **P** **Pump**
E.P. **Electricity Pylon** **S.P.** **Signal Post**
F.B. **Foot Bridge** **Sl.** **Sluice**
F.P. **Foot Path** **Sp.** **Spring**
G.P. **Guide Post or Board** **T.C.B.** **Telephone Call Box**
M.S. **Mile Stone** **Tr.** **Trough**
M.P. M.R. **Mooring Post or Ring** **W** **Well**

Ordnance Survey Plan, Additional SIMs and Supply of Unpublished Survey Information 1:2,500 and 1:1,250

Inactive Quarry, Chalk Pit or Clay Pit **Active Quarry, Chalk Pit or Clay Pit**
Rock **Boulders**
Cliff **Slopes** **Top**
Roofed Building **Glazed Roof Building**
Sloping Masonry **Archway**
Non-Coniferous Tree (surveyed) **Coniferous Tree (surveyed)**
Non-Coniferous Trees (not surveyed) **Coniferous Trees (not surveyed)**
Orchard Tree **Scrub** **Bracken**
Coppice, Osier **Reeds** **Marsh, Saltings**
Rough Grassland **Heath** **Culvert**
Direction of water flow **Bench Mark** **Antiquity (site of)**
Cave Entrance **Triangulation Station** **Electricity Pylon**
Electricity Transmission Line
County Boundary (Geographical)
County & Civil Parish Boundary
Civil Parish Boundary
Admin. County or County Bor. Boundary
London Borough Boundary
Symbol marking point where boundary mereing changes
Beer House **Pillar, Pole or Post**
Boundary Post or Stone **Post Office**
Capstan, Crane **Public Convenience**
Chimney **Public House**
Drinking Fountain **Pump**
Electricity Pillar or Post **Signal Box or Bridge**
Fire Alarm Pillar **Signal Post or Light**
Foot Bridge **Spring**
Guide Post **Tank or Track**
Hydrant or Hydraulic **Telephone Call Box**
Level Crossing **Telephone Call Post**
Manhole **Trough**
Mile Post or Mooring Post **Water Point, Water Tap**
Mile Stone **Well**
Normal Tidal Limit **Wind Pump**

Large-Scale National Grid Data 1:2,500 and 1:1,250

Cliff **Slopes** **Top**
Rock **Rock (scattered)**
Boulders **Boulders (scattered)**
Positioned Boulder **Scree**
Non-Coniferous Tree (surveyed) **Coniferous Tree (surveyed)**
Non-Coniferous Trees (not surveyed) **Coniferous Trees (not surveyed)**
Orchard Tree **Scrub** **Bracken**
Coppice, Osier **Reeds** **Marsh, Saltings**
Rough Grassland **Heath** **Culvert**
Direction of water flow **Triangulation Station** **Antiquity (site of)**
Electricity Transmission Line **Electricity Pylon**
Bench Mark **Buildings with Building Seed**
Roofed Building **Glazed Roof Building**
Civil parish/community boundary
District boundary
County boundary
Boundary post/stone
Boundary mereing symbol (note: these always appear in opposed pairs or groups of three)
Barracks **Pillar, Pole or Post**
Battery **Post Office**
Cemetery **Public Convenience**
Chimney **Pump**
Cistern **Pumping Station**
Dismtd Rly **Place of Worship**
Electricity Generating Station **Sewage Ppg Sta** **Sewage Pumping Station**
Electricity Pole, Pillar **Signal Box or Bridge**
Electricity Sub Station **Signal Post or Light**
Filter Bed **Spring**
Fountain / Drinking Ftn. **Tank or Track**
Gas Valve Compound **Trough**
Gas Governor **Wind Pump**
Guide Post **Water Point, Water Tap**
Manhole **Works (building or area)**
Mile Post or Mile Stone **Well**

Historical Mapping & Photography included:

Mapping Type	Scale	Date	Pg
Lincolnshire	1:2,500	1886	2
Lincolnshire	1:2,500	1906	3
Lincolnshire	1:2,500	1920	4
Ordnance Survey Plan	1:2,500	1973 - 1974	5
Additional SIMs	1:2,500	1993	6
Large-Scale National Grid Data	1:2,500	1994	7

Historical Map - Segment D2

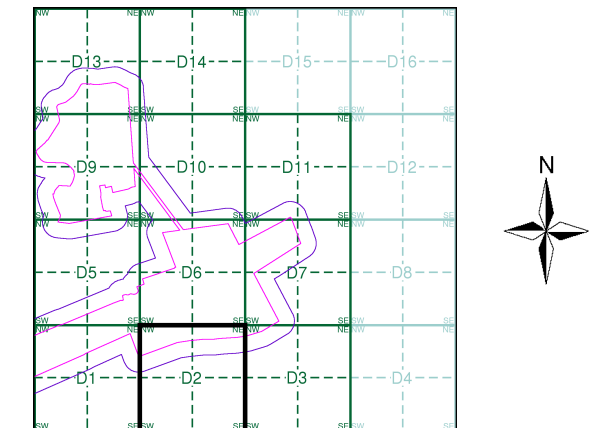

Order Details

Order Number: 298001007_1_1
 Customer Ref: 21-1098.04
 National Grid Reference: 491280, 377900
 Slice: D
 Site Area (Ha): 471.82
 Search Buffer (m): 100

Site Details

West Barton 1

Lincolnshire

Published 1886

Source map scale - 1:2,500

The historical maps shown were reproduced from maps predominantly held at the scale adopted for England, Wales and Scotland in the 1840's. In 1854 the 1:2,500 scale was adopted for mapping urban areas and by 1896 it covered the whole of what were considered to be the cultivated parts of Great Britain. The published date given below is often some years later than the surveyed date. Before 1938, all OS maps were based on the Cassini Projection, with independent surveys of a single county or group of counties, giving rise to significant inaccuracies in outlying areas.

Map Name(s) and Date(s)

060_08	1886	1:2,500
060_12	1886	1:2,500

Historical Map - Segment D2

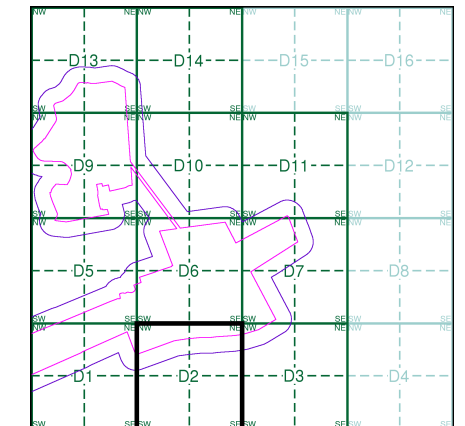

Order Details

Order Number: 298001007_1_1
 Customer Ref: 21-1098.04
 National Grid Reference: 491280, 377900
 Slice: D
 Site Area (Ha): 471.82
 Search Buffer (m): 100

Site Details

West Barton 1

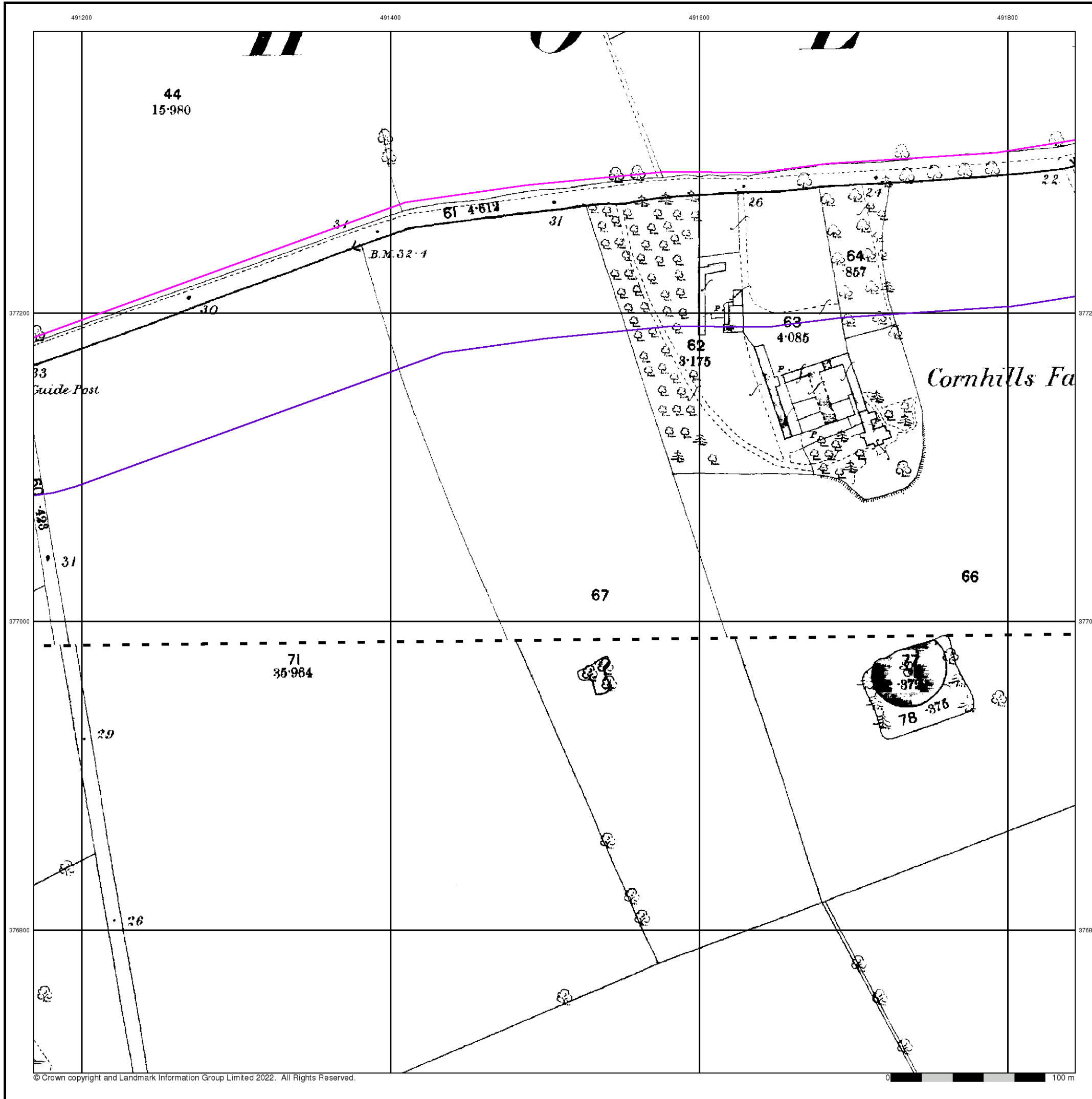

Lincolnshire

Published 1906

Source map scale - 1:2,500

The historical maps shown were reproduced from maps predominantly held at the scale adopted for England, Wales and Scotland in the 1840's. In 1854 the 1:2,500 scale was adopted for mapping urban areas and by 1896 it covered the whole of what were considered to be the cultivated parts of Great Britain. The published date given below is often some years later than the surveyed date. Before 1938, all OS maps were based on the Cassini Projection, with independent surveys of a single county or group of counties, giving rise to significant inaccuracies in outlying areas.

Map Name(s) and Date(s)

060_08	1906	1:2,500
060_12	1906	1:2,500

Historical Map - Segment D2

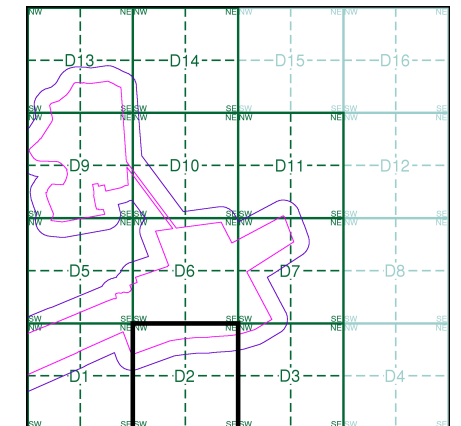

Order Details

Order Number: 298001007_1_1
 Customer Ref: 21-1098.04
 National Grid Reference: 491280, 377900
 Slice: D
 Site Area (Ha): 471.82
 Search Buffer (m): 100

Site Details

West Barton 1

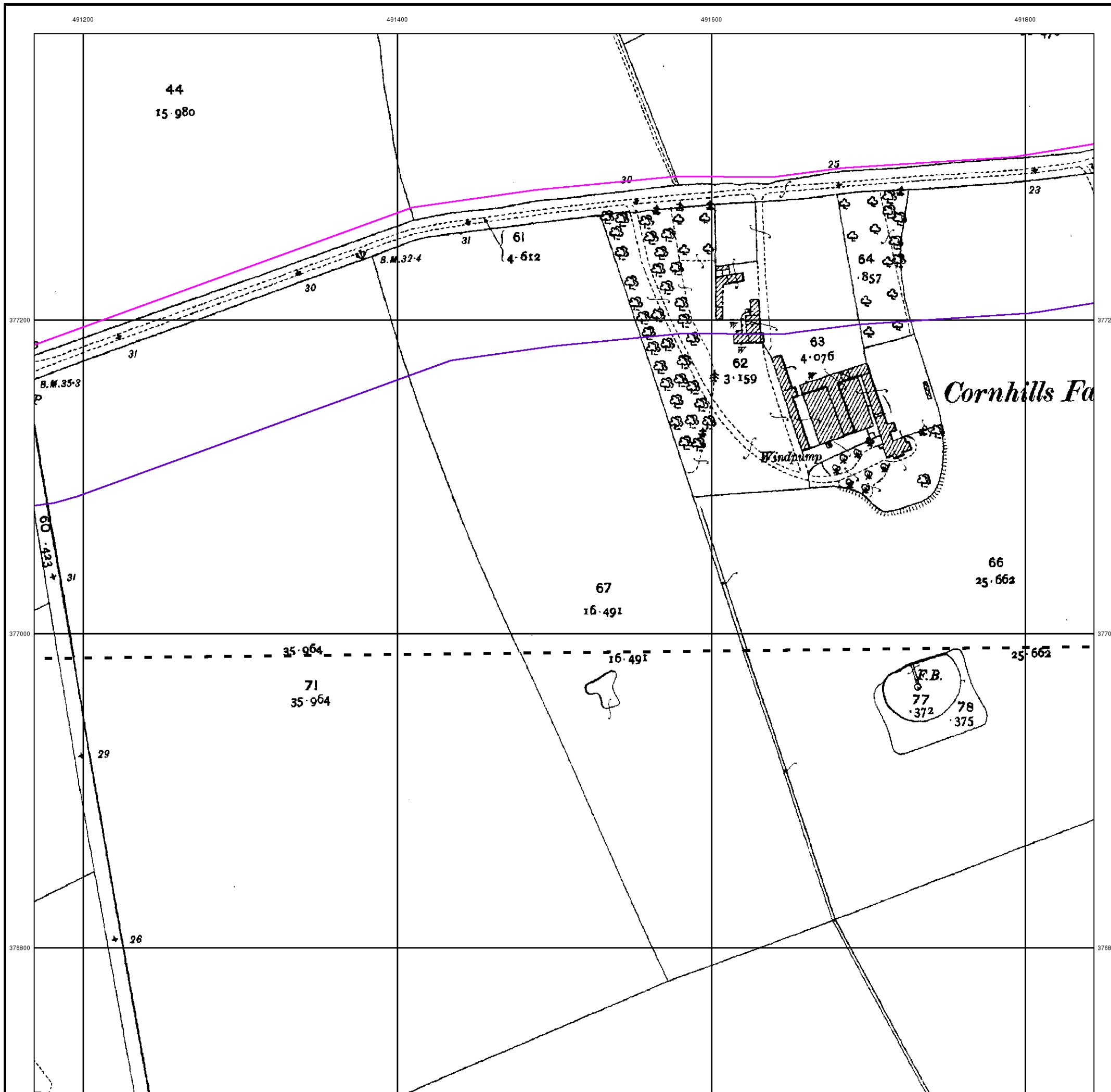

491200

491400

491600

491800



Lincolnshire

Published 1920

Source map scale - 1:2,500

The historical maps shown were reproduced from maps predominantly held at the scale adopted for England, Wales and Scotland in the 1840's. In 1854 the 1:2,500 scale was adopted for mapping urban areas and by 1896 it covered the whole of what were considered to be the cultivated parts of Great Britain. The published date given below is often some years later than the surveyed date. Before 1938, all OS maps were based on the Cassini Projection, with independent surveys of a single county or group of counties, giving rise to significant inaccuracies in outlying areas.

Map Name(s) and Date(s)

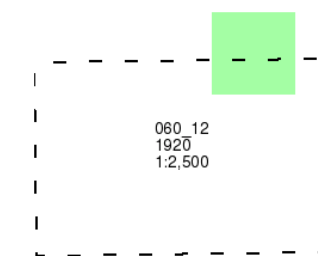

Historical Map - Segment D2

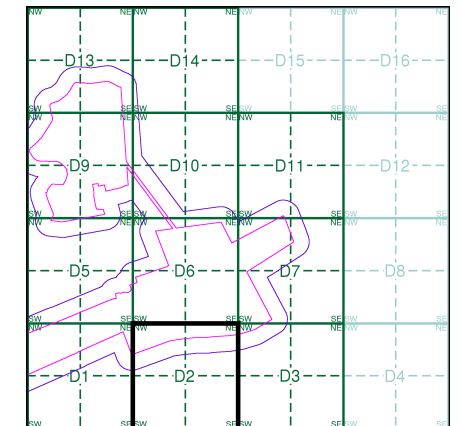

Order Details

Order Number:	298001007_1_1
Customer Ref:	21-1098.04
National Grid Reference:	491280, 377900
Slice:	D
Site Area (Ha):	471.82
Search Buffer (m):	100

Site Details

West Barton 1



Tel:	0844 844 9952
Fax:	0844 844 9951
Web:	[REDACTED]

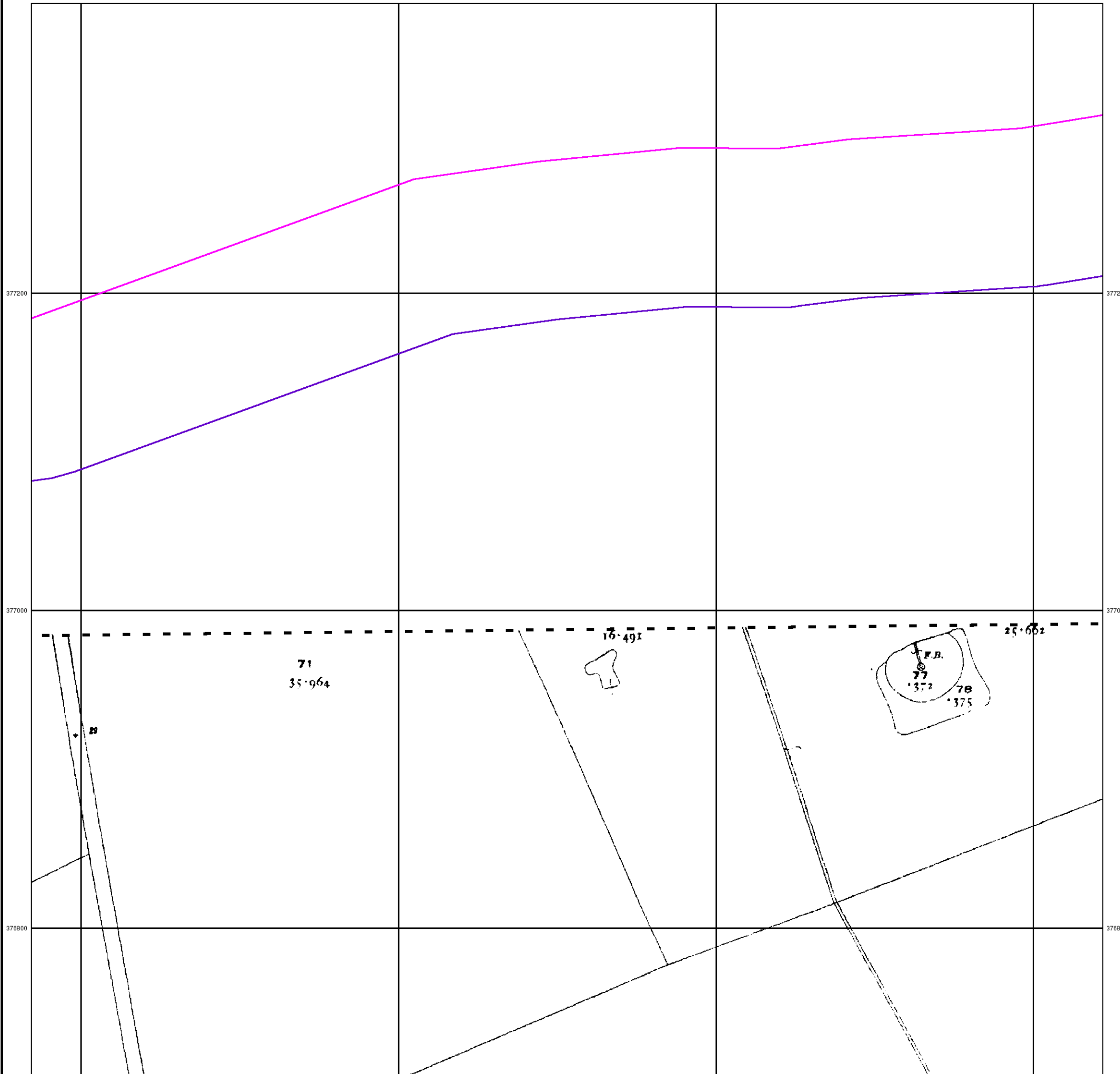

Ordnance Survey Plan
Published 1973 - 1974
Source map scale - 1:2,500

The historical maps shown were reproduced from maps predominantly held at the scale adopted for England, Wales and Scotland in the 1840's. In 1854 the 1:2,500 scale was adopted for mapping urban areas and by 1896 it covered the whole of what were considered to be the cultivated parts of Great Britain. The published date given below is often some years later than the surveyed date. Before 1938, all OS maps were based on the Cassini Projection, with independent surveys of a single county or group of counties, giving rise to significant inaccuracies in outlying areas.

Map Name(s) and Date(s)

SK9177	1974	1:2,500
SK9176	1973	1:2,500

Historical Map - Segment D2

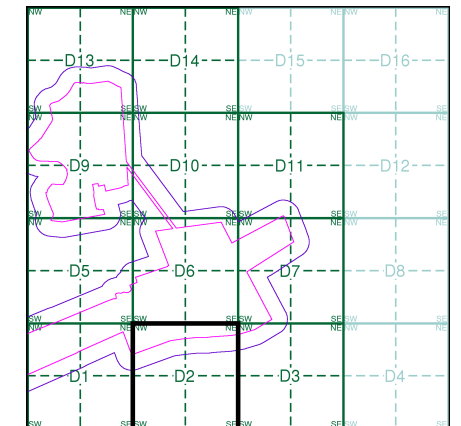

Order Details

Order Number: 298001007_1_1
 Customer Ref: 21-1098.04
 National Grid Reference: 491280, 377900
 Slice: D
 Site Area (Ha): 471.82
 Search Buffer (m): 100

Site Details

West Barton 1

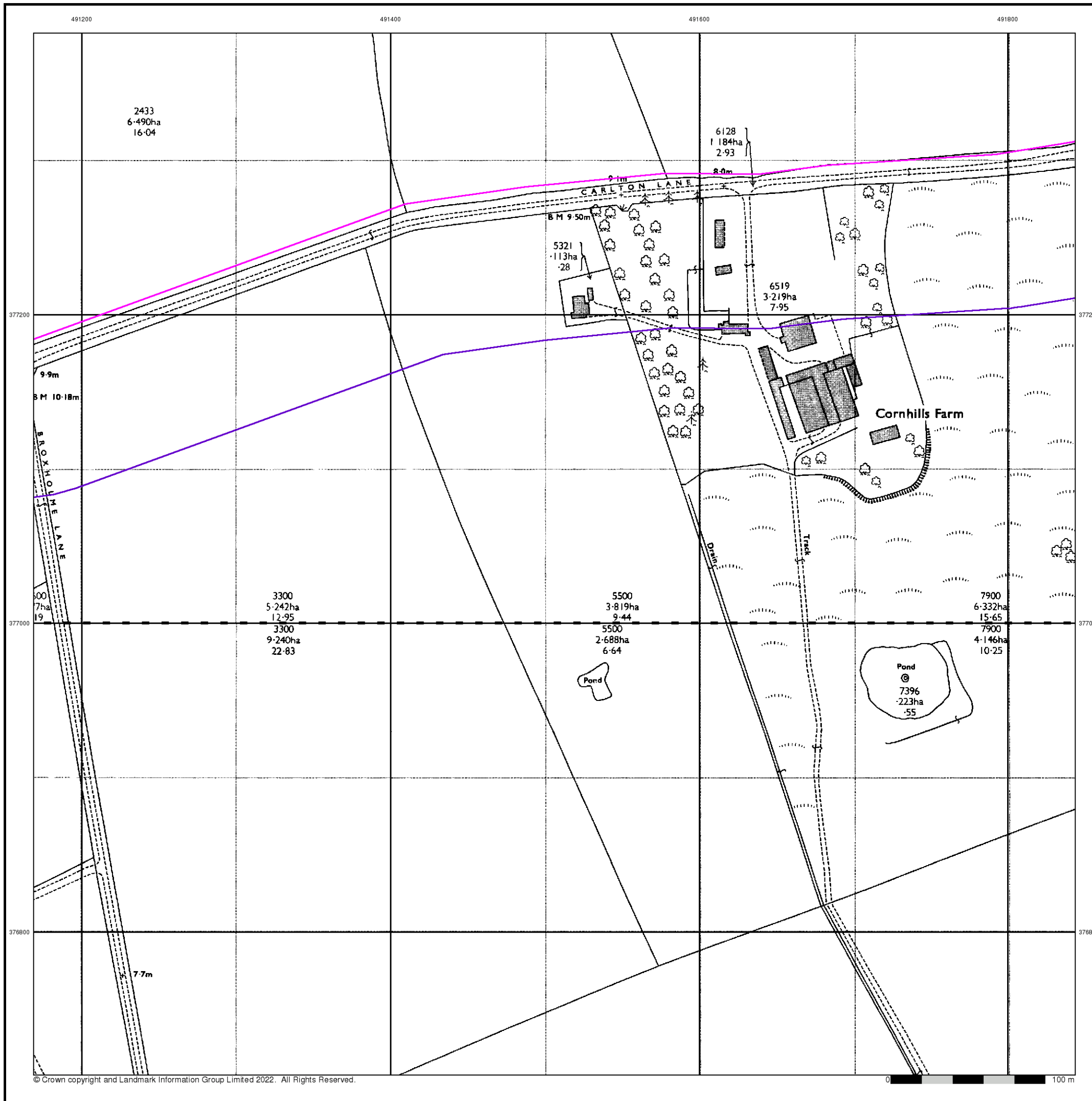

491200

491400

491600

491800

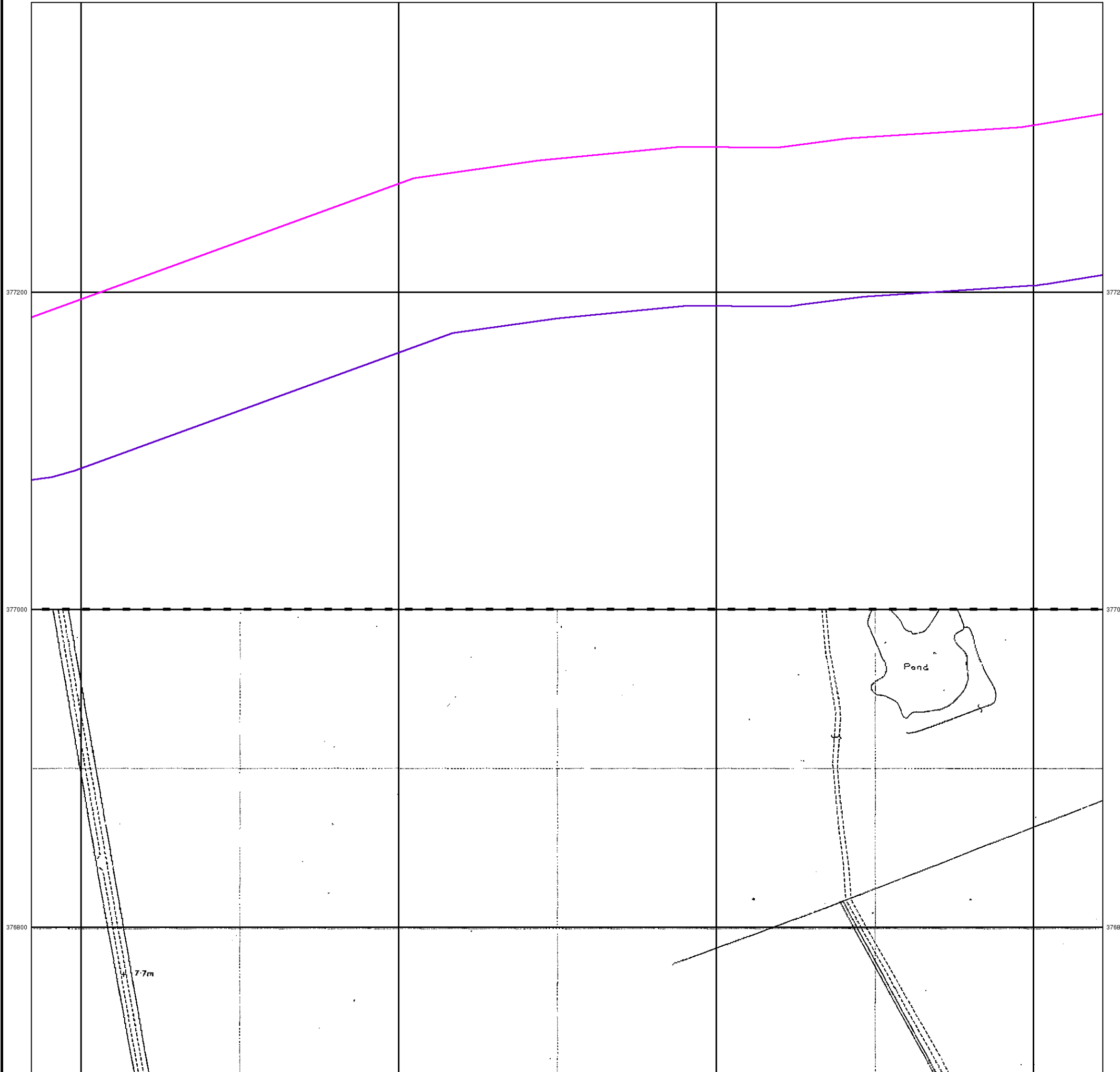

© Crown copyright and Landmark Information Group Limited 2022. All Rights Reserved.



Additional SIMs

Published 1993

Source map scale - 1:2,500

The SIM cards (Ordnance Survey's 'Survey of Information on Microfilm') are further, minor editions of mapping which were produced and published in between the main editions as an area was updated. They date from 1947 to 1994, and contain detailed information on buildings, roads and land-use. These maps were produced at both 1:2,500 and 1:1,250 scales.

Map Name(s) and Date(s)

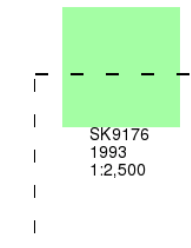

Historical Map - Segment D2

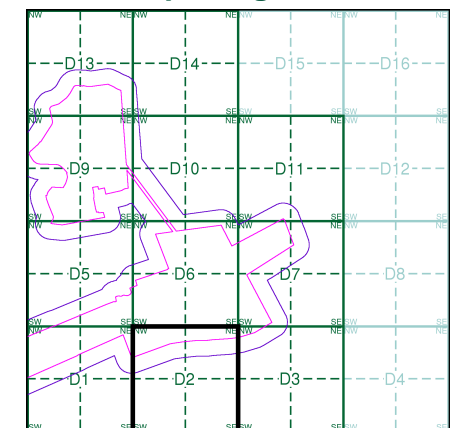

Order Details

Order Number: 298001007_1_1
 Customer Ref: 21-1098.04
 National Grid Reference: 491280, 377900
 Slice: D
 Site Area (Ha): 471.82
 Search Buffer (m): 100

Site Details

West Barton 1



Tel: 0844 844 9952
 Fax: 0844 844 9951
 Web: [REDACTED]

Large-Scale National Grid Data

Published 1994

Source map scale - 1:2,500

'Large Scale National Grid Data' superseded SIM cards (Ordnance Survey's 'Survey of Information on Microfilm') in 1992, and continued to be produced until 1999. These maps were the fore-runners of digital mapping and so provide detailed information on houses and roads, but tend to show less topographic features such as vegetation. These maps were produced at both 1:2,500 and 1:1,250 scales.

Map Name(s) and Date(s)

SK9177	1994	1:2,500
SK9176	1994	1:2,500

Historical Map - Segment D2

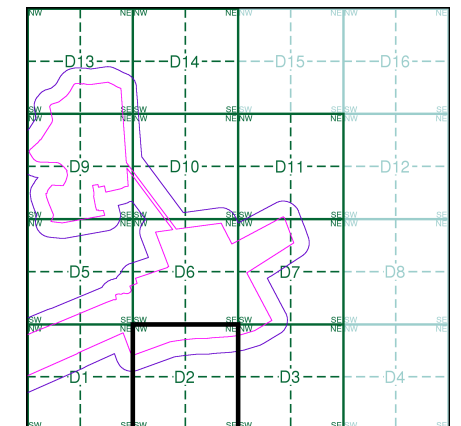

Order Details

Order Number: 298001007_1_1
 Customer Ref: 21-1098.04
 National Grid Reference: 491280, 377900
 Slice: D
 Site Area (Ha): 471.82
 Search Buffer (m): 100

Site Details

West Barton 1



Historical Mapping Legends

Ordnance Survey County Series and Ordnance Survey Plan 1:2,500

Quarry **Gravel Pit** **Sand Pit**
Clay Pit **Shingle** **Refuse Heap**
Sloping Masonry **Flat Rock**
Marsh **Reeds** **Osiers**
Rough Pasture **Furze** **Wood**
Mixed Wood **Brushwood** **Orchard**
Fir **Ford** **Stepping Stones**
Ferry **Waterfall** **Lock**
Trig. Station **Altitude at Trig. Station**
B.M. 325.9 **Bench Mark** **Surface Level**
Arrow denotes flow of water **Antiquities (site of)**
Cutting **Embankment**
Railway crossing Road **Level Crossing** **Road crossing Railway**
Railway crossing River or Canal **Road over single stream** **Road over River or Canal**
County Boundary (Geographical)
County & Civil Parish Boundary
Administrative County & Civil Parish Boundary
County Borough Boundary (England)
Co. Boro. Bdy.
County Burgh Boundary (Scotland)
Boundary Post or Stone **Police Call Box**
B.R. **Bridle Road** **P** **Pump**
E.P. **Electricity Pylon** **S.P.** **Signal Post**
F.B. **Foot Bridge** **Sl.** **Sluice**
F.P. **Foot Path** **Sp.** **Spring**
G.P. **Guide Post or Board** **T.C.B.** **Telephone Call Box**
M.S. **Mile Stone** **Tr.** **Trough**
M.P. M.R. **Mooring Post or Ring** **W** **Well**

Ordnance Survey Plan, Additional SIMs and Supply of Unpublished Survey Information 1:2,500 and 1:1,250

Inactive Quarry, Chalk Pit or Clay Pit **Active Quarry, Chalk Pit or Clay Pit**
Rock **Boulders**
Cliff **Slopes** **Top**
Roofed Building **Glazed Roof Building**
Sloping Masonry **Archway**
Non-Coniferous Tree (surveyed) **Coniferous Tree (surveyed)**
Non-Coniferous Trees (not surveyed) **Coniferous Trees (not surveyed)**
Orchard Tree **Scrub** **Bracken**
Coppice, Osier **Reeds** **Marsh, Saltings**
Rough Grassland **Heath** **Culvert**
Direction of water flow **Bench Mark** **Antiquity (site of)**
Cave Entrance **Triangulation Station** **Electricity Pylon**
Electricity Transmission Line
County Boundary (Geographical)
County & Civil Parish Boundary
Civil Parish Boundary
Admin. County or County Bor. Boundary
London Borough Boundary
Symbol marking point where boundary mereing changes
Beer House **Pillar, Pole or Post**
Boundary Post or Stone **Post Office**
Capstan, Crane **Public Convenience**
Chimney **Public House**
Drinking Fountain **Pump**
Electricity Pillar or Post **Signal Box or Bridge**
Fire Alarm Pillar **Signal Post or Light**
Foot Bridge **Spring**
Guide Post **Tank or Track**
Hydrant or Hydraulic **Telephone Call Box**
Level Crossing **Telephone Call Post**
Manhole **Trough**
Mile Post or Mooring Post **Water Point, Water Tap**
Mile Stone **Well**
Normal Tidal Limit **Wind Pump**

Large-Scale National Grid Data 1:2,500 and 1:1,250

Cliff **Slopes** **Top**
Rock **Rock (scattered)**
Boulders **Boulders (scattered)**
Positioned Boulder **Scree**
Non-Coniferous Tree (surveyed) **Coniferous Tree (surveyed)**
Non-Coniferous Trees (not surveyed) **Coniferous Trees (not surveyed)**
Orchard Tree **Scrub** **Bracken**
Coppice, Osier **Reeds** **Marsh, Saltings**
Rough Grassland **Heath** **Culvert**
Direction of water flow **Triangulation Station** **Antiquity (site of)**
Electricity Transmission Line **Electricity Pylon**
Bench Mark **Buildings with Building Seed**
Roofed Building **Glazed Roof Building**
Civil parish/community boundary
District boundary
County boundary
Boundary post/stone
Boundary mereing symbol (note: these always appear in opposed pairs or groups of three)
Barracks **Pillar, Pole or Post**
Battery **Post Office**
Cemetery **Public Convenience**
Chimney **Pump**
Cistern **Pumping Station**
Dismtd Rly **Place of Worship**
Electricity Generating Station **Sewage Ppg Sta** **Sewage Pumping Station**
Electricity Pole, Pillar **Signal Box or Bridge**
Electricity Sub Station **Signal Post or Light**
Filter Bed **Spring**
Fountain / Drinking Ftn. **Tank or Track**
Gas Valve Compound **Trough**
Gas Governor **Wind Pump**
Guide Post **Water Point, Water Tap**
Manhole **Works (building or area)**
Mile Post or Mile Stone **Well**

Historical Mapping & Photography included:

Mapping Type	Scale	Date	Pg
Lincolnshire	1:2,500	1886 - 1887	2
Lincolnshire	1:2,500	1906	3
Lincolnshire	1:2,500	1920	4
Ordnance Survey Plan	1:2,500	1973 - 1974	5
Additional SIMs	1:2,500	1993	6
Large-Scale National Grid Data	1:2,500	1994	7

Historical Map - Segment D3

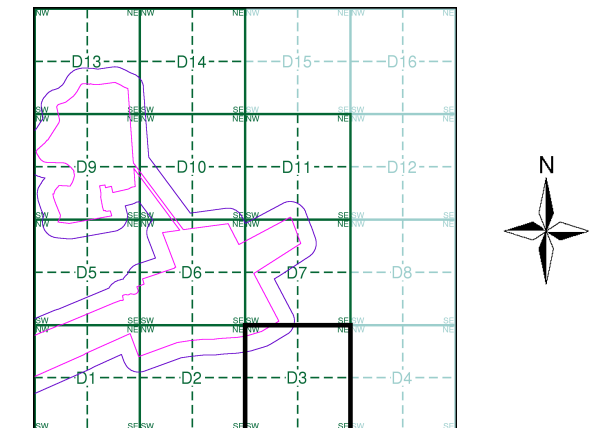

Order Details

Order Number: 298001007_1_1
 Customer Ref: 21-1098.04
 National Grid Reference: 491280, 377900
 Slice: D
 Site Area (Ha): 471.82
 Search Buffer (m): 100

Site Details

West Barton 1

Lincolnshire

Published 1886 - 1887

Source map scale - 1:2,500

The historical maps shown were reproduced from maps predominantly held at the scale adopted for England, Wales and Scotland in the 1840's. In 1854 the 1:2,500 scale was adopted for mapping urban areas and by 1896 it covered the whole of what were considered to be the cultivated parts of Great Britain. The published date given below is often some years later than the surveyed date. Before 1938, all OS maps were based on the Cassini Projection, with independent surveys of a single county or group of counties, giving rise to significant inaccuracies in outlying areas.

Map Name(s) and Date(s)

060_08 1886 1:2,500	061_05 1886 1:2,500
060_12 1886 1:2,500	061_09 1887 1:2,500

Historical Map - Segment D3

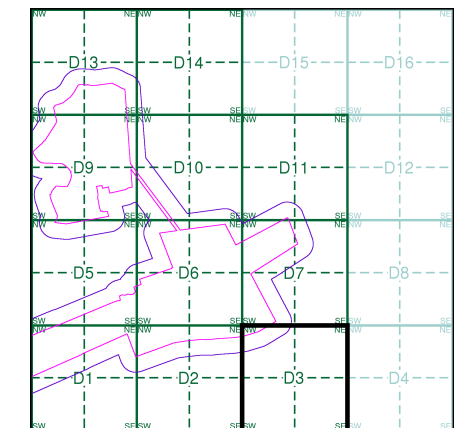

Order Details

Order Number: 298001007_1_1
 Customer Ref: 21-1098.04
 National Grid Reference: 491280, 377900
 Slice: D
 Site Area (Ha): 471.82
 Search Buffer (m): 100

Site Details

West Barton 1

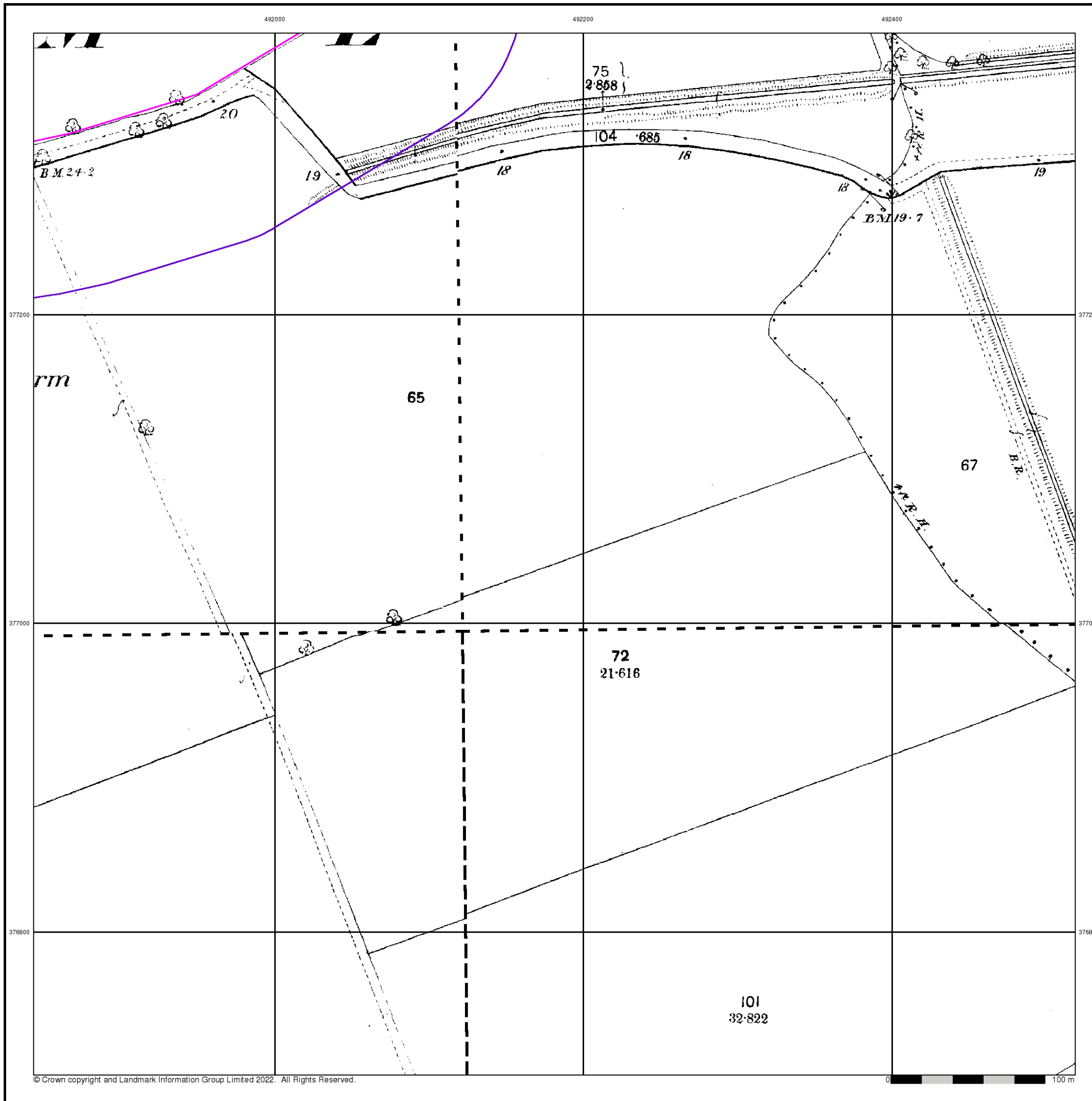

Lincolnshire

Published 1906

Source map scale - 1:2,500

The historical maps shown were reproduced from maps predominantly held at the scale adopted for England, Wales and Scotland in the 1840's. In 1854 the 1:2,500 scale was adopted for mapping urban areas and by 1896 it covered the whole of what were considered to be the cultivated parts of Great Britain. The published date given below is often some years later than the surveyed date. Before 1938, all OS maps were based on the Cassini Projection, with independent surveys of a single county or group of counties, giving rise to significant inaccuracies in outlying areas.

Map Name(s) and Date(s)

060_08 1906 1:2,500	061_05 1906 1:2,500
060_12 1906 1:2,500	061_09 1906 1:2,500

Historical Map - Segment D3

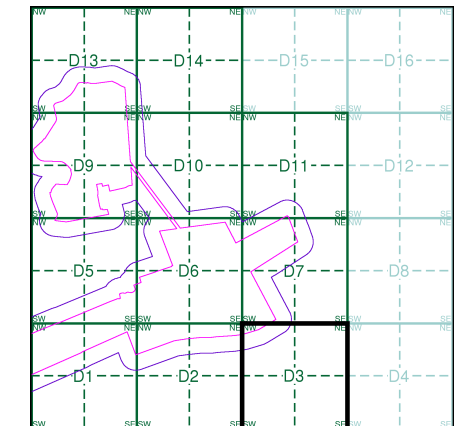

Order Details

Order Number: 298001007_1_1
 Customer Ref: 21-1098.04
 National Grid Reference: 491280, 377900
 Slice: D
 Site Area (Ha): 471.82
 Search Buffer (m): 100

Site Details

West Barton 1

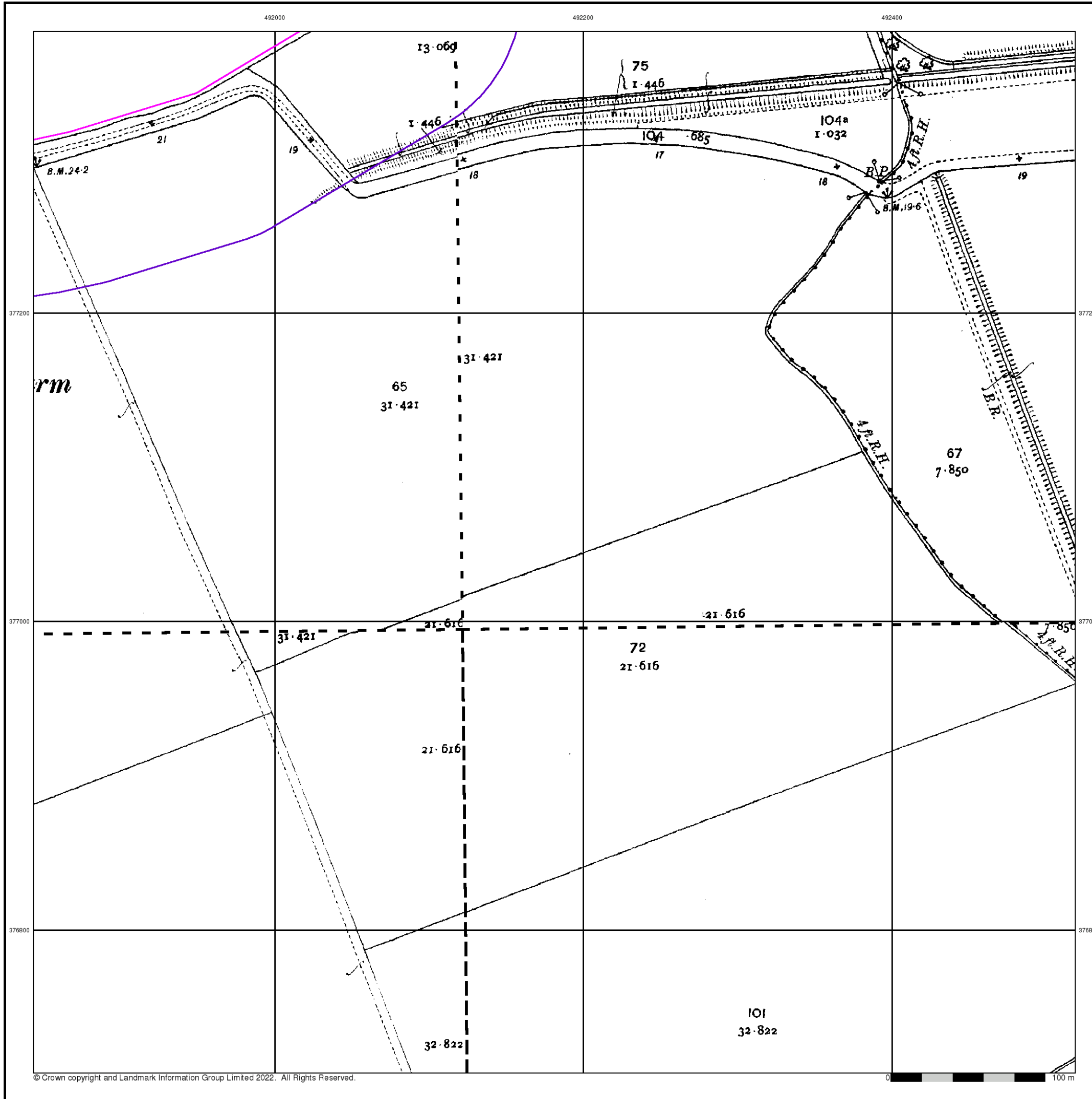

492000

492200

492400

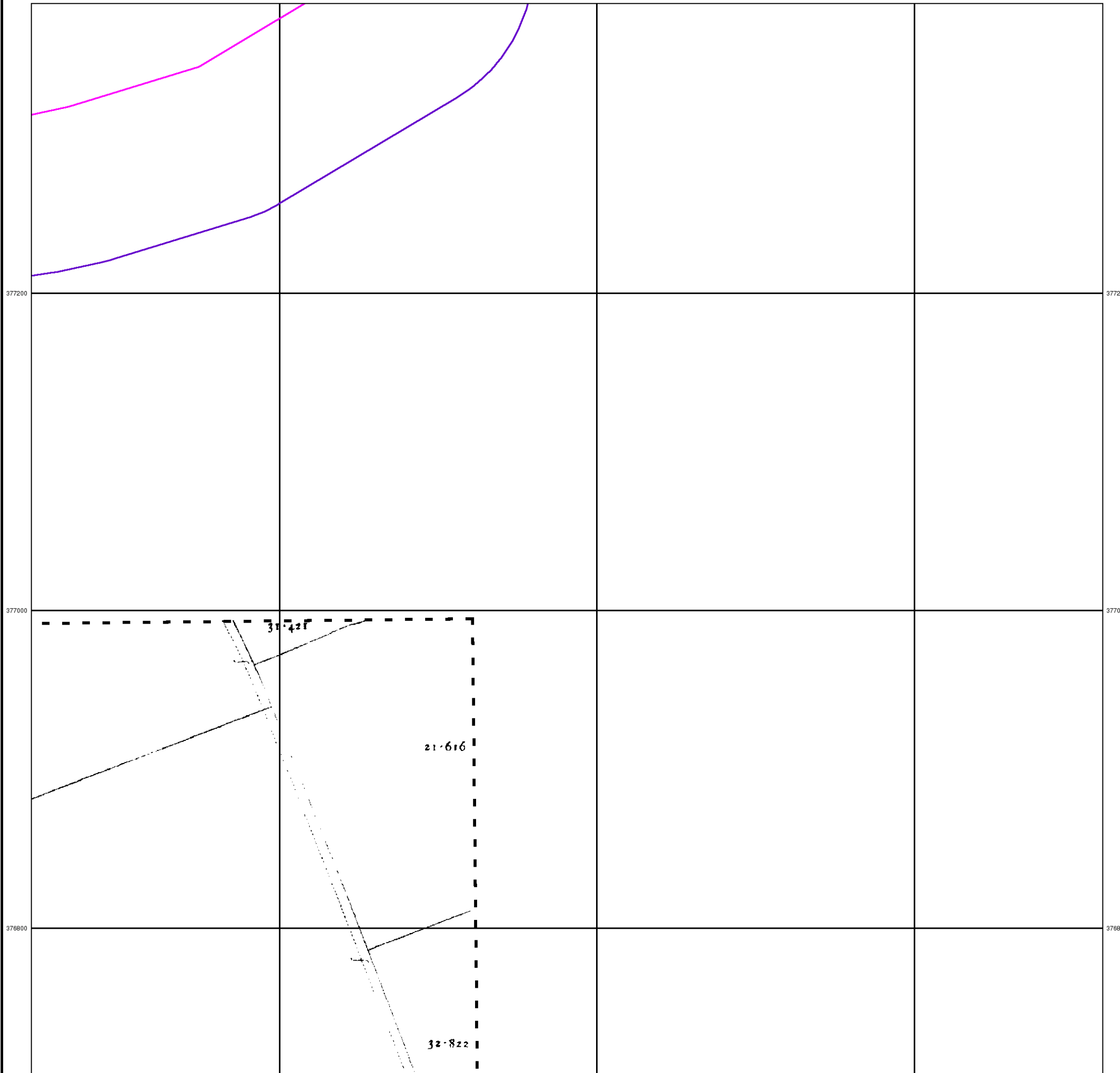

© Crown copyright and Landmark Information Group Limited 2022. All Rights Reserved.

0 100 m



Lincolnshire

Published 1920

Source map scale - 1:2,500

The historical maps shown were reproduced from maps predominantly held at the scale adopted for England, Wales and Scotland in the 1840's. In 1854 the 1:2,500 scale was adopted for mapping urban areas and by 1896 it covered the whole of what were considered to be the cultivated parts of Great Britain. The published date given below is often some years later than the surveyed date. Before 1938, all OS maps were based on the Cassini Projection, with independent surveys of a single county or group of counties, giving rise to significant inaccuracies in outlying areas.

Map Name(s) and Date(s)

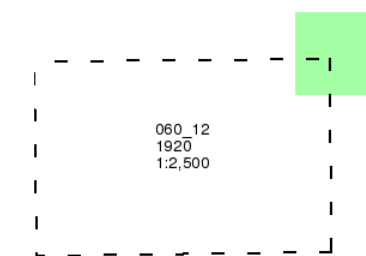

Historical Map - Segment D3

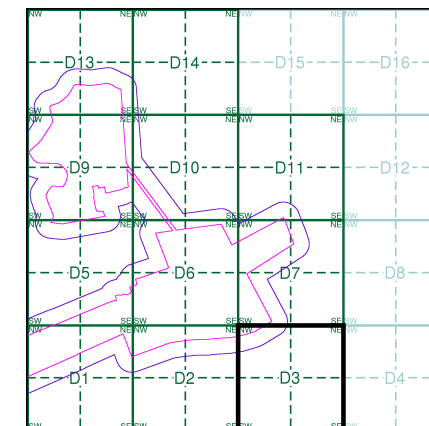

Order Details

Order Number: 298001007_1_1
 Customer Ref: 21-1098.04
 National Grid Reference: 491280, 377900
 Slice: D
 Site Area (Ha): 471.82
 Search Buffer (m): 100

Site Details

West Barton 1



Tel: 0844 844 9952
 Fax: 0844 844 9951
 Web: [REDACTED]

Ordnance Survey Plan
Published 1973 - 1974
Source map scale - 1:2,500

The historical maps shown were reproduced from maps predominantly held at the scale adopted for England, Wales and Scotland in the 1840's. In 1854 the 1:2,500 scale was adopted for mapping urban areas and by 1896 it covered the whole of what were considered to be the cultivated parts of Great Britain. The published date given below is often some years later than the surveyed date. Before 1938, all OS maps were based on the Cassini Projection, with independent surveys of a single county or group of counties, giving rise to significant inaccuracies in outlying areas.

Map Name(s) and Date(s)

SK9177 1974 1:2,500	SK9277 1973 1:2,500
SK9176 1973 1:2,500	SK9276 1973 1:2,500

Historical Map - Segment D3

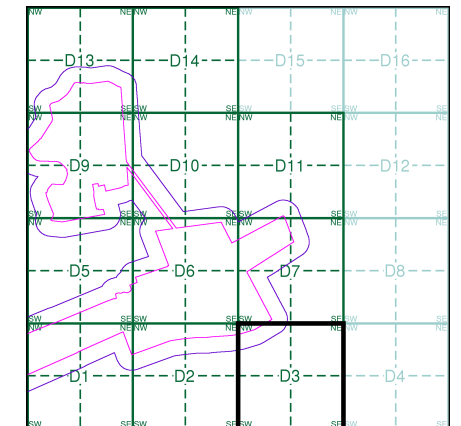

Order Details

Order Number: 298001007_1_1
 Customer Ref: 21-1098.04
 National Grid Reference: 491280, 377900
 Slice: D
 Site Area (Ha): 471.82
 Search Buffer (m): 100

Site Details

West Barton 1

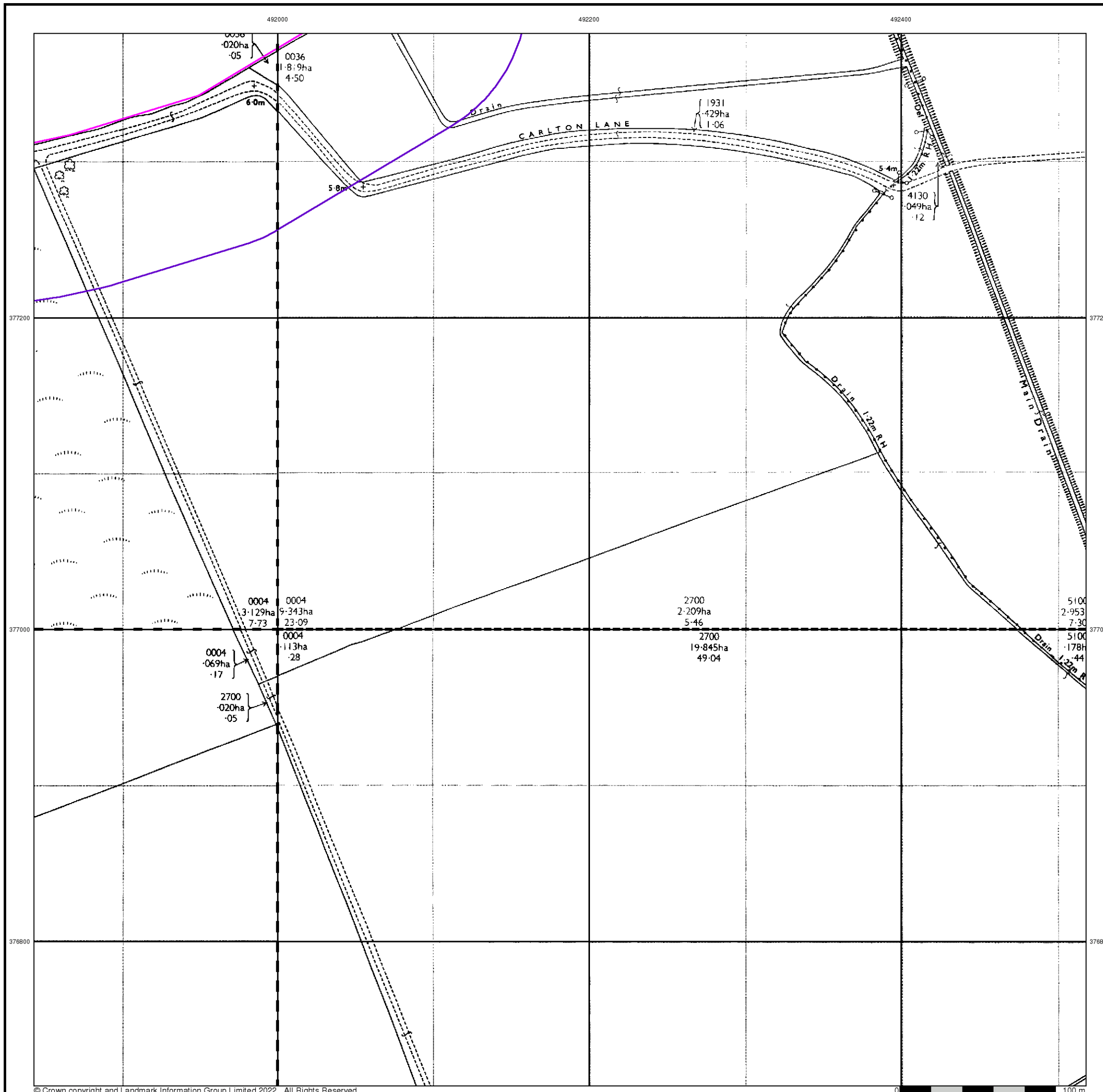

Additional SIMs

Published 1993

Source map scale - 1:2,500

The SIM cards (Ordnance Survey's 'Survey of Information on Microfilm') are further, minor editions of mapping which were produced and published in between the main editions as an area was updated. They date from 1947 to 1994, and contain detailed information on buildings, roads and land-use. These maps were produced at both 1:2,500 and 1:1,250 scales.

Map Name(s) and Date(s)

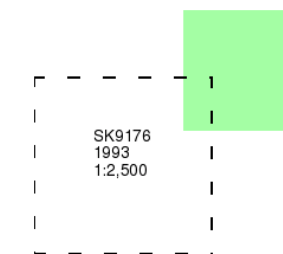

Historical Map - Segment D3

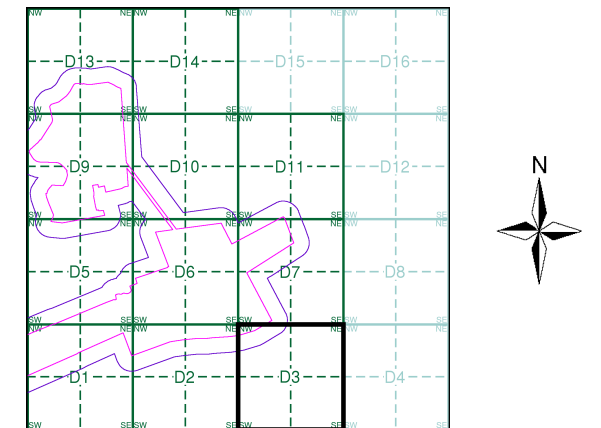

Order Details

Order Number: 298001007_1_1
 Customer Ref: 21-1098.04
 National Grid Reference: 491280, 377900
 Slice: D
 Site Area (Ha): 471.82
 Search Buffer (m): 100

Site Details

West Barton 1

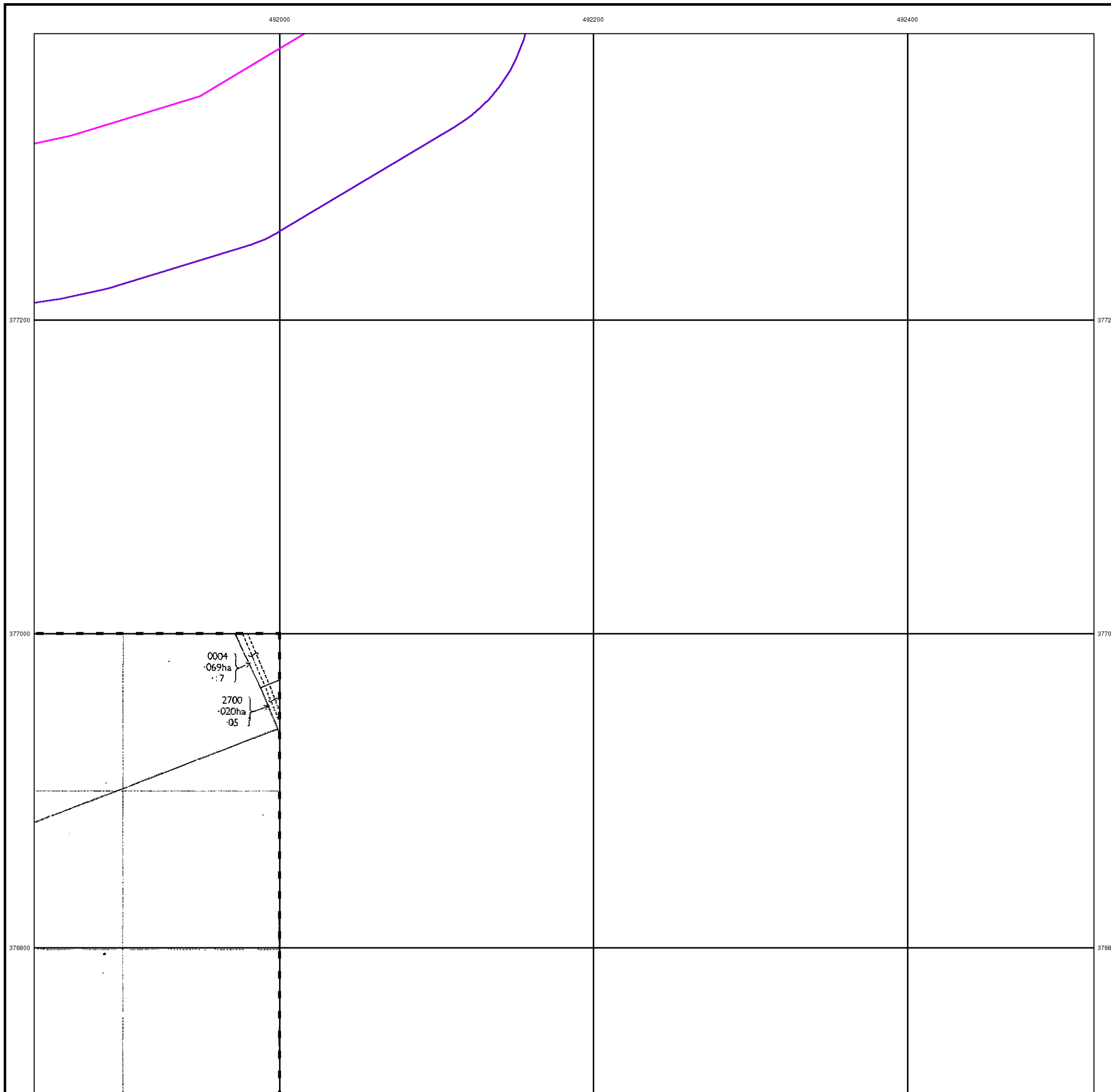

Large-Scale National Grid Data

Published 1994

Source map scale - 1:2,500

'Large Scale National Grid Data' superseded SIM cards (Ordnance Survey's 'Survey of Information on Microfilm') in 1992, and continued to be produced until 1999. These maps were the fore-runners of digital mapping and so provide detailed information on houses and roads, but tend to show less topographic features such as vegetation. These maps were produced at both 1:2,500 and 1:1,250 scales.

Map Name(s) and Date(s)

SK9177	SK9277
1994	1994
12,500	12,500
SK9176	SK9276
1994	1994
12,500	12,500

Historical Map - Segment D3

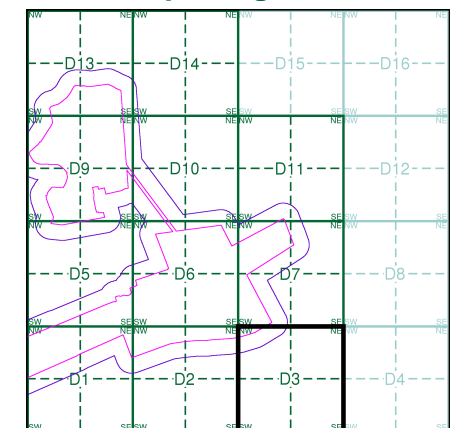

Order Details

Order Number: 298001007_1_1
 Customer Ref: 21-1098.04
 National Grid Reference: 491280, 377900
 Slice: D
 Site Area (Ha): 471.82
 Search Buffer (m): 100

Site Details

West Barton 1

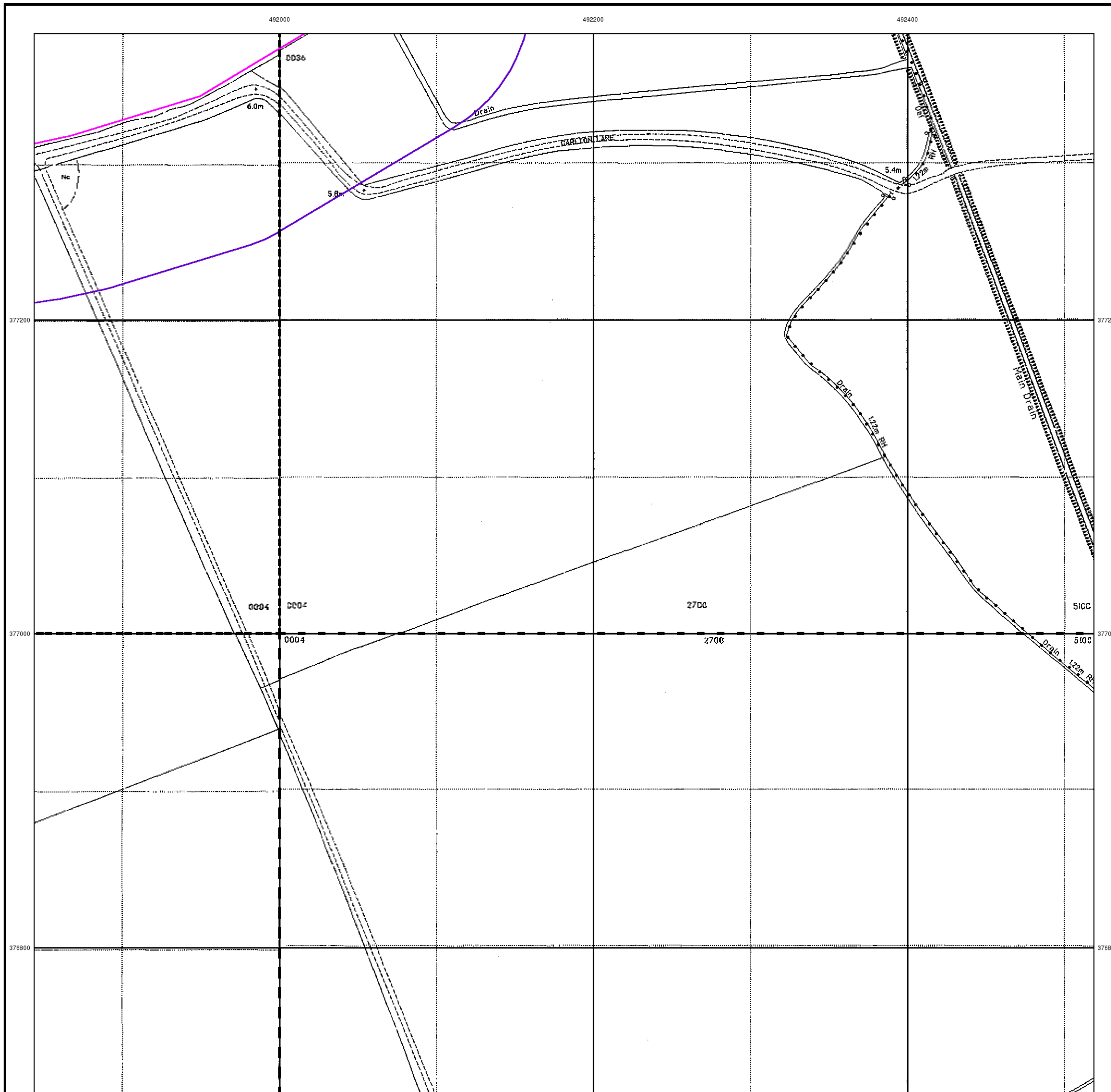

Historical Mapping Legends

Ordnance Survey County Series and Ordnance Survey Plan 1:2,500

Quarry **Gravel Pit** **Sand Pit**
Clay Pit **Shingle** **Refuse Heap**
Sloping Masonry **Flat Rock**
Marsh **Reeds** **Osiers**
Rough Pasture **Furze** **Wood**
Mixed Wood **Brushwood** **Orchard**
Fir **Ford** **Stepping Stones**
Ferry **Waterfall** **Lock**
Trig. Station **Altitude at Trig. Station**
B.M. 325.9 **Bench Mark** **Surface Level**
Arrow denotes flow of water **Antiquities (site of)**
Cutting **Embankment**
Railway crossing Road **Level Crossing** **Road crossing Railway**
Railway crossing River or Canal **Road over single stream** **Road over River or Canal**
County Boundary (Geographical)
County & Civil Parish Boundary
Administrative County & Civil Parish Boundary
County Borough Boundary (England)
County Burgh Boundary (Scotland)
Boundary Post or Stone **Police Call Box**
B.R. Bridle Road **Pump**
E.P. Electricity Pylon **S.P. Signal Post**
F.B. Foot Bridge **Sl. Sluice**
F.P. Foot Path **Sp. Spring**
G.P. Guide Post or Board **T.C.B. Telephone Call Box**
M.S. Mile Stone **Tr. Trough**
M.P. M.R. Mooring Post or Ring **W. Well**

Ordnance Survey Plan, Additional SIMs and Supply of Unpublished Survey Information 1:2,500 and 1:1,250

Inactive Quarry, Chalk Pit or Clay Pit **Active Quarry, Chalk Pit or Clay Pit**
Rock **Boulders**
Cliff **Slopes** **Top**
Roofed Building **Glazed Roof Building**
Sloping Masonry **Archway**
Non-Coniferous Tree (surveyed) **Coniferous Tree (surveyed)**
Non-Coniferous Trees (not surveyed) **Coniferous Trees (not surveyed)**
Orchard Tree **Scrub** **Bracken**
Coppice, Osier **Reeds** **Marsh, Saltings**
Rough Grassland **Heath** **Culvert**
Direction of water flow **Bench Mark** **Antiquity (site of)**
Cave Entrance **Triangulation Station** **Electricity Pylon**
Electricity Transmission Line
County Boundary (Geographical)
County & Civil Parish Boundary
Civil Parish Boundary
Admin. County or County Bor. Boundary
London Borough Boundary
Symbol marking point where boundary mereing changes
Beer House **Pillar, Pole or Post**
Boundary Post or Stone **Post Office**
Capstan, Crane **Public Convenience**
Chimney **Public House**
Drinking Fountain **Pump**
Electricity Pillar or Post **Signal Box or Bridge**
Fire Alarm Pillar **Signal Post or Light**
Foot Bridge **Spring**
Guide Post **Tank or Track**
Hydrant or Hydraulic **Telephone Call Box**
Level Crossing **Telephone Call Post**
Manhole **Trough**
Mile Post or Mooring Post **Water Point, Water Tap**
Mile Stone **Well**
Normal Tidal Limit **Wind Pump**

Large-Scale National Grid Data 1:2,500 and 1:1,250

Cliff **Slopes** **Top**
Rock **Rock (scattered)**
Boulders **Boulders (scattered)**
Positioned Boulder **Scree**
Non-Coniferous Tree (surveyed) **Coniferous Tree (surveyed)**
Non-Coniferous Trees (not surveyed) **Coniferous Trees (not surveyed)**
Orchard Tree **Scrub** **Bracken**
Coppice, Osier **Reeds** **Marsh, Saltings**
Rough Grassland **Heath** **Culvert**
Direction of water flow **Triangulation Station** **Antiquity (site of)**
Electricity Transmission Line **Electricity Pylon**
Bench Mark **Buildings with Building Seed**
Roofed Building **Glazed Roof Building**
Civil parish/community boundary
District boundary
County boundary
Boundary post/stone
Boundary mereing symbol (note: these always appear in opposed pairs or groups of three)
Barracks **Pillar, Pole or Post**
Battery **Post Office**
Cemetery **Public Convenience**
Chimney **Pump**
Cistern **Pumping Station**
Dismtd Rly **Place of Worship**
Electricity Generating Station **Sewage Ppg Sta** **Sewage Pumping Station**
Electricity Pole, Pillar **Signal Box or Bridge**
Electricity Sub Station **Signal Post or Light**
Filter Bed **Spring**
Fountain / Drinking Ftn. **Tank or Track**
Gas Valve Compound **Trough**
Gas Governor **Wind Pump**
Guide Post **Water Point, Water Tap**
Manhole **Works (building or area)**
Mile Post or Mile Stone **Well**

Historical Mapping & Photography included:

Mapping Type	Scale	Date	Pg
Lincolnshire	1:2,500	1886	2
Lincolnshire	1:2,500	1906	3
Ordnance Survey Plan	1:2,500	1974	4
Large-Scale National Grid Data	1:2,500	1994	5

Historical Map - Segment D5

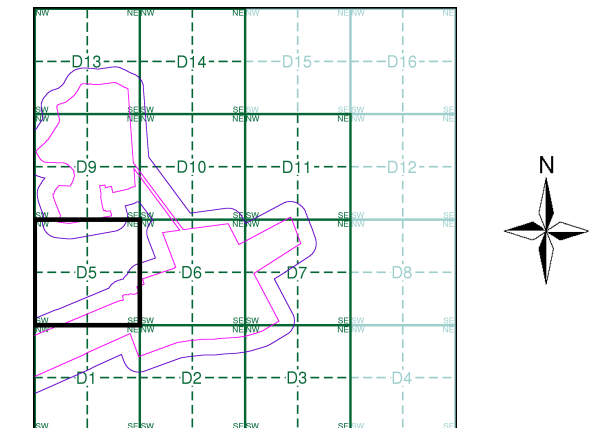

Order Details

Order Number: 298001007_1_1
 Customer Ref: 21-1098.04
 National Grid Reference: 491280, 377900
 Slice: D
 Site Area (Ha): 471.82
 Search Buffer (m): 100

Site Details

West Barton 1

Lincolnshire

Published 1886

Source map scale - 1:2,500

The historical maps shown were reproduced from maps predominantly held at the scale adopted for England, Wales and Scotland in the 1840's. In 1854 the 1:2,500 scale was adopted for mapping urban areas and by 1896 it covered the whole of what were considered to be the cultivated parts of Great Britain. The published date given below is often some years later than the surveyed date. Before 1938, all OS maps were based on the Cassini Projection, with independent surveys of a single county or group of counties, giving rise to significant inaccuracies in outlying areas.

Map Name(s) and Date(s)

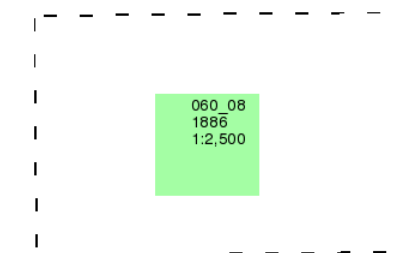

Historical Map - Segment D5

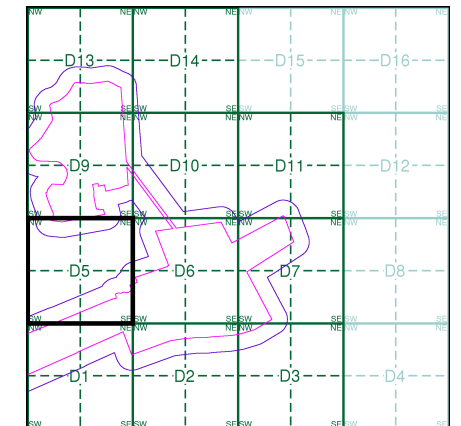

Order Details

Order Number: 298001007_1_1
 Customer Ref: 21-1098.04
 National Grid Reference: 491280, 377900
 Slice: D
 Site Area (Ha): 471.82
 Search Buffer (m): 100

Site Details

West Barton 1

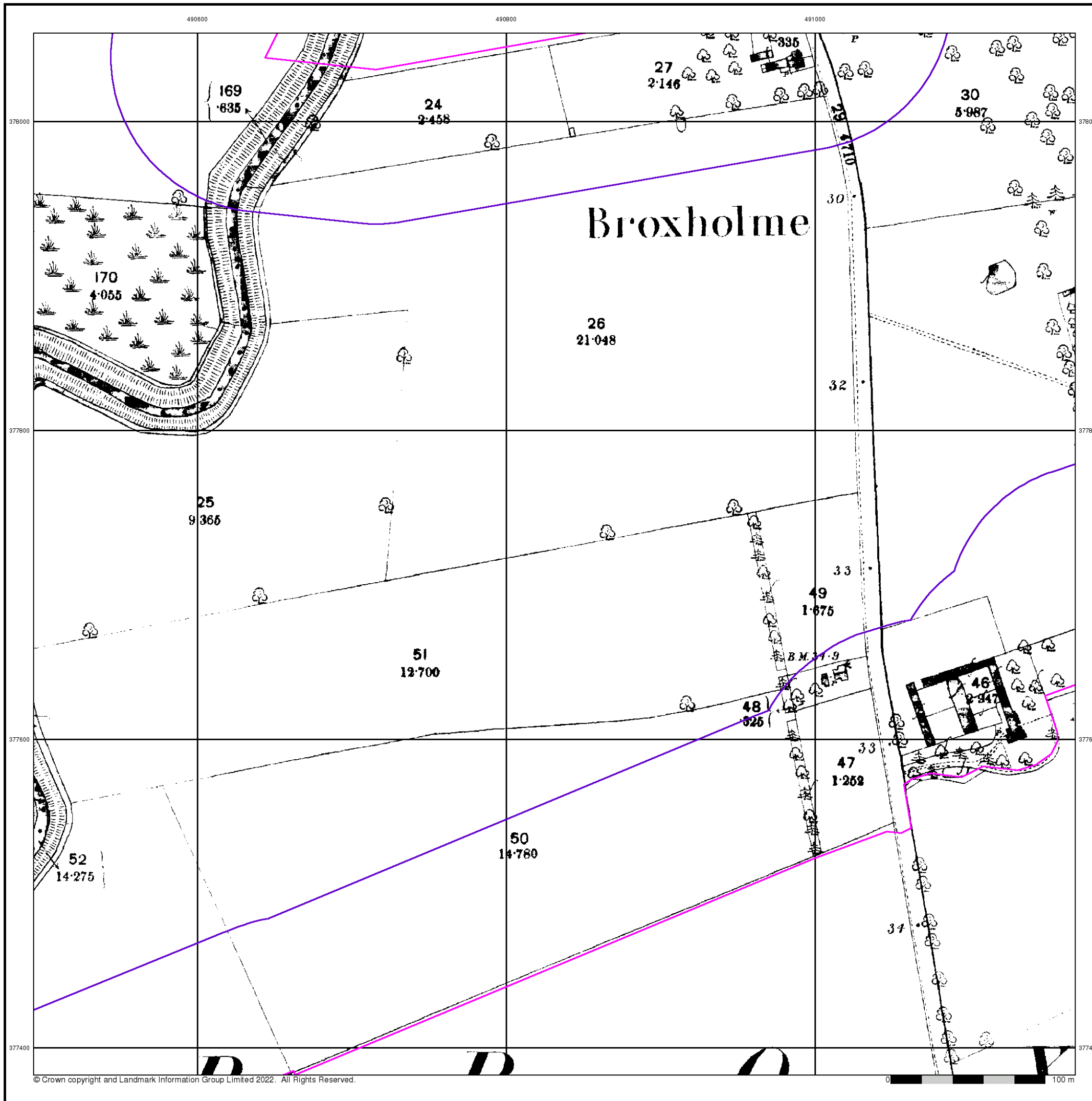

Lincolnshire

Published 1906

Source map scale - 1:2,500

The historical maps shown were reproduced from maps predominantly held at the scale adopted for England, Wales and Scotland in the 1840's. In 1854 the 1:2,500 scale was adopted for mapping urban areas and by 1896 it covered the whole of what were considered to be the cultivated parts of Great Britain. The published date given below is often some years later than the surveyed date. Before 1938, all OS maps were based on the Cassini Projection, with independent surveys of a single county or group of counties, giving rise to significant inaccuracies in outlying areas.

Map Name(s) and Date(s)

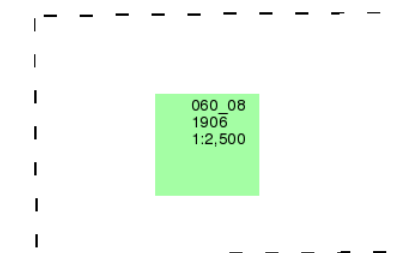

Historical Map - Segment D5

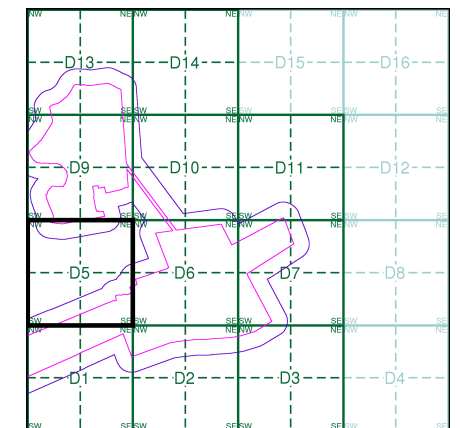

Order Details

Order Number: 298001007_1_1
 Customer Ref: 21-1098.04
 National Grid Reference: 491280, 377900
 Slice: D
 Site Area (Ha): 471.82
 Search Buffer (m): 100

Site Details

West Barton 1

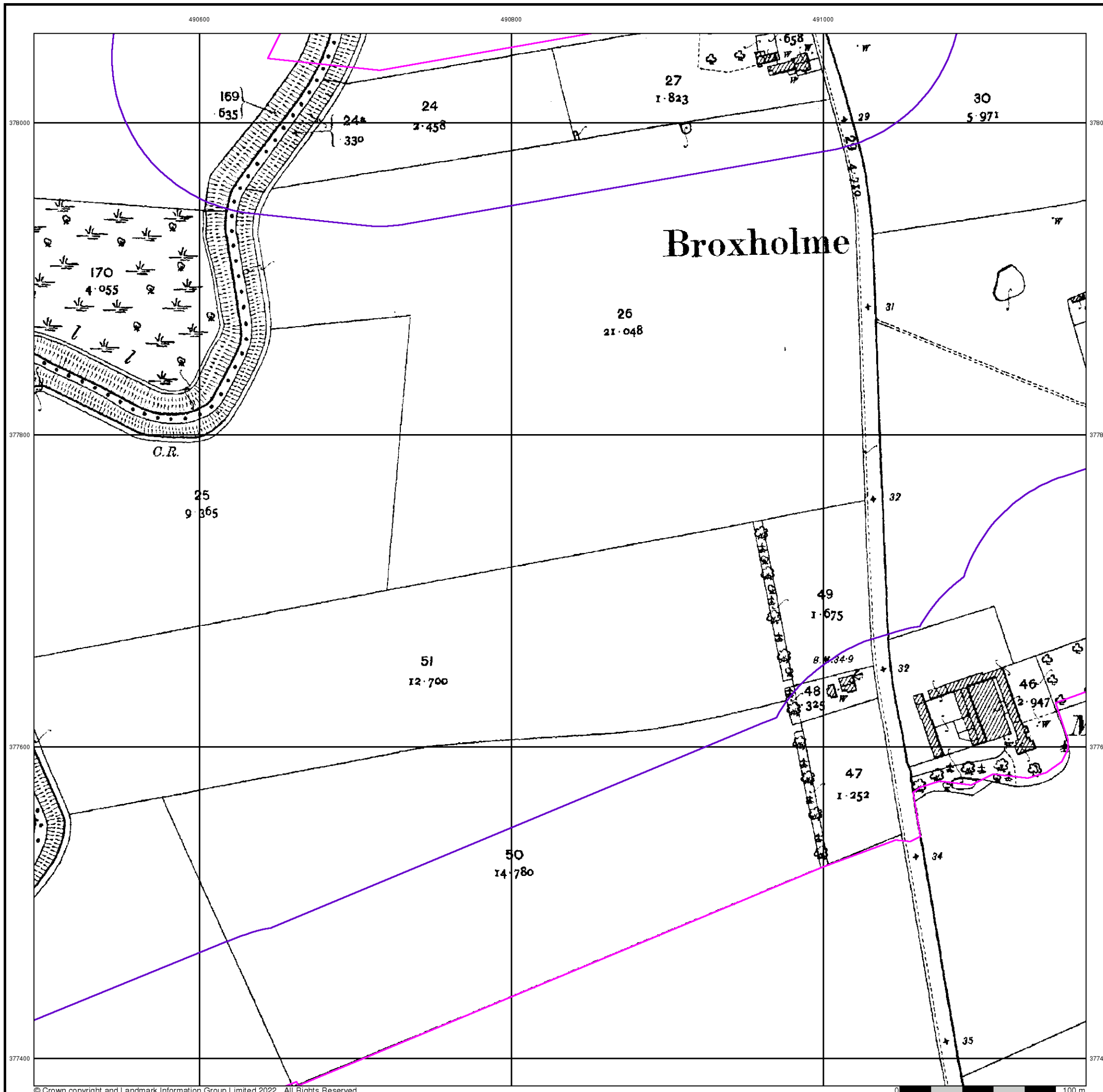

Ordnance Survey Plan

Published 1974

Source map scale - 1:2,500

The historical maps shown were reproduced from maps predominantly held at the scale adopted for England, Wales and Scotland in the 1840's. In 1854 the 1:2,500 scale was adopted for mapping urban areas and by 1896 it covered the whole of what were considered to be the cultivated parts of Great Britain. The published date given below is often some years later than the surveyed date. Before 1938, all OS maps were based on the Cassini Projection, with independent surveys of a single county or group of counties, giving rise to significant inaccuracies in outlying areas.

Map Name(s) and Date(s)

SK9078 1974 1:2,500	SK9178 1974 1:2,500
SK9077 1974 1:2,500	SK9177 1974 1:2,500

Historical Map - Segment D5

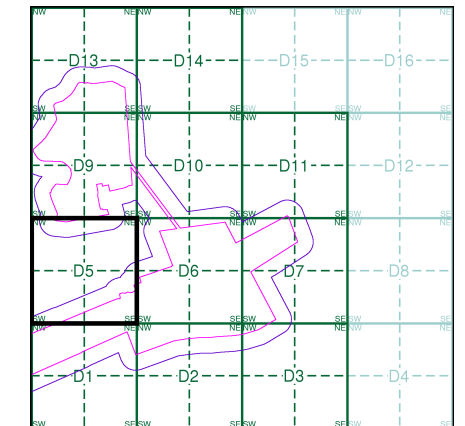

Order Details

Order Number: 298001007_1_1
 Customer Ref: 21-1098.04
 National Grid Reference: 491280, 377900
 Slice: D
 Site Area (Ha): 471.82
 Search Buffer (m): 100

Site Details

West Barton 1

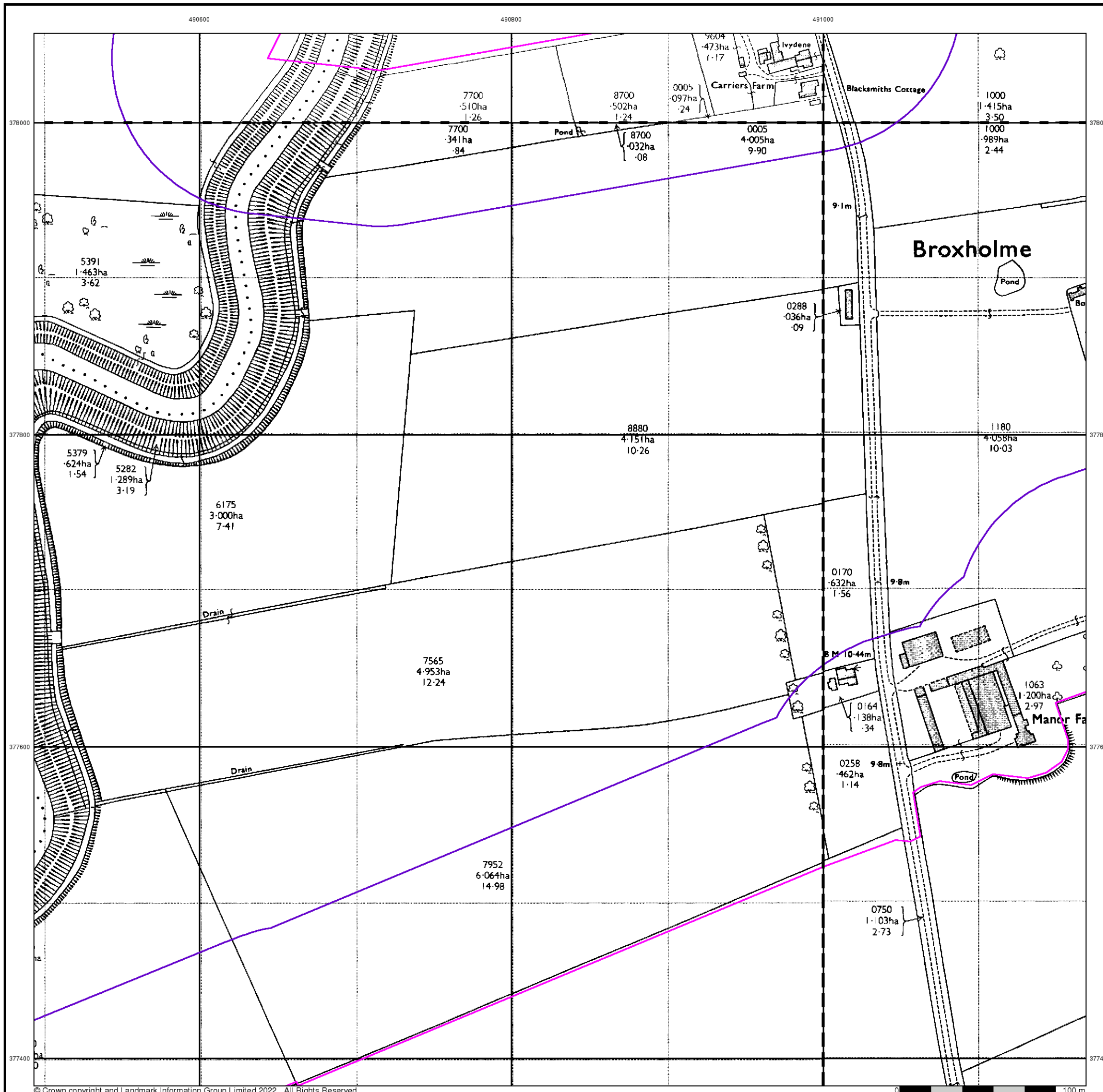

Large-Scale National Grid Data

Published 1994

Source map scale - 1:2,500

'Large Scale National Grid Data' superseded SIM cards (Ordnance Survey's 'Survey of Information on Microfilm') in 1992, and continued to be produced until 1999. These maps were the fore-runners of digital mapping and so provide detailed information on houses and roads, but tend to show less topographic features such as vegetation. These maps were produced at both 1:2,500 and 1:1,250 scales.

Map Name(s) and Date(s)

SK9078 1994 1:2,500	SK9178 1994 1:2,500
SK9077 1994 1:2,500	SK9177 1994 1:2,500

Historical Map - Segment D5

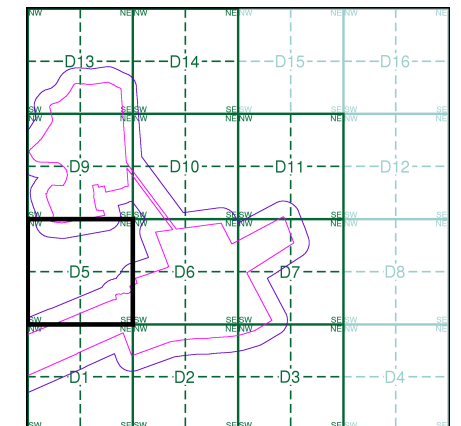

Order Details

Order Number: 298001007_1_1
 Customer Ref: 21-1098.04
 National Grid Reference: 491280, 377900
 Slice: D
 Site Area (Ha): 471.82
 Search Buffer (m): 100

Site Details

West Barton 1

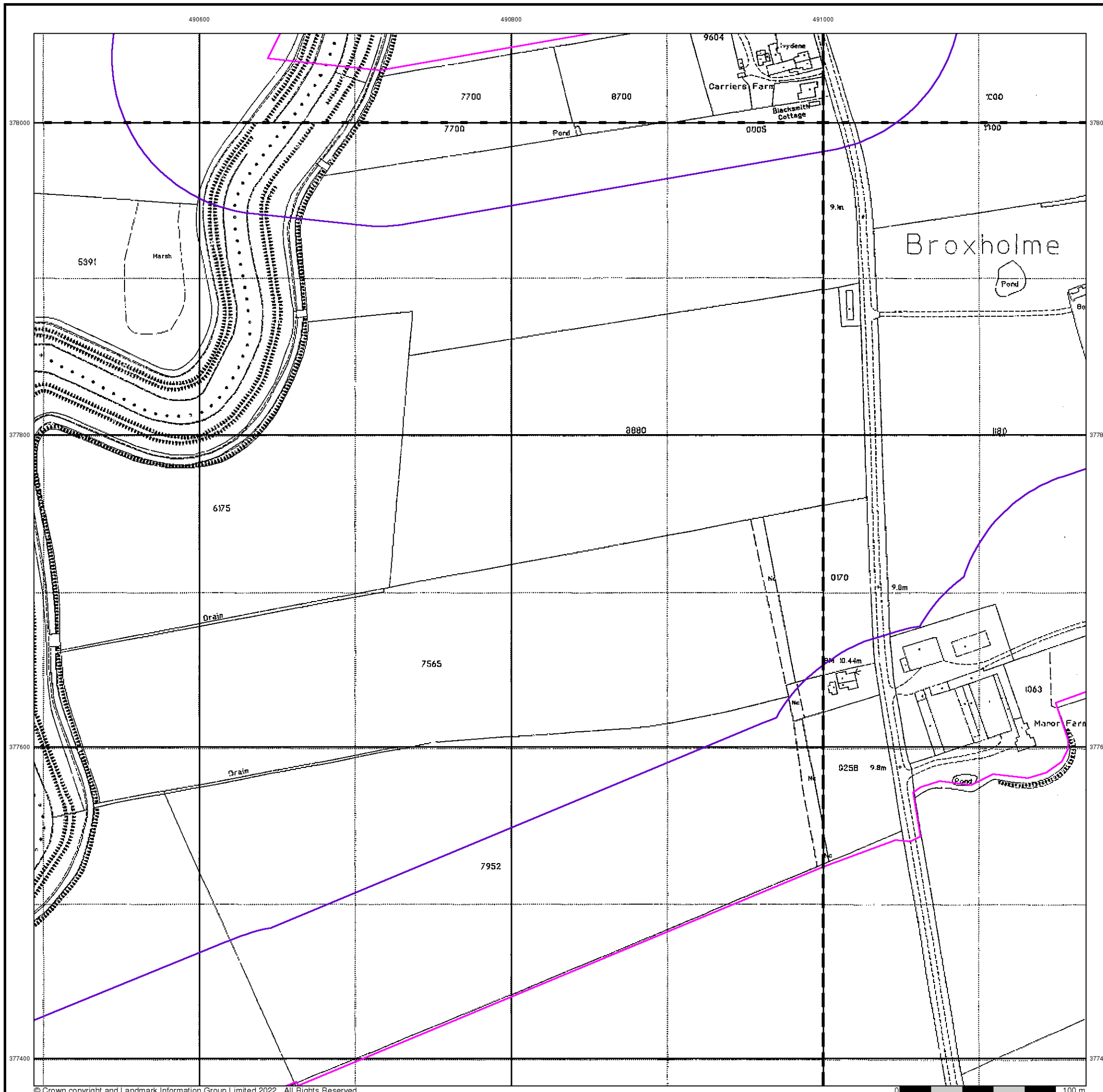

Historical Mapping Legends

Ordnance Survey County Series and Ordnance Survey Plan 1:2,500

Quarry **Gravel Pit** **Sand Pit**
Clay Pit **Shingle** **Refuse Heap**
Sloping Masonry **Flat Rock**
Marsh **Reeds** **Osiers**
Rough Pasture **Furze** **Wood**
Mixed Wood **Brushwood** **Orchard**
Fir **Ford** **Stepping Stones**
Ferry **Waterfall** **Lock**
Trig. Station 507 **Altitude at Trig. Station**
B.M. 325.9 **Bench Mark** 342 **Surface Level**
Arrow denotes flow of water **Antiquities (site of)**
Cutting **Embankment**
Railway crossing Road **Level Crossing** **Road crossing Railway**
Railway crossing River or Canal **Road over single stream** **Road over River or Canal**
County Boundary (Geographical)
County & Civil Parish Boundary
Administrative County & Civil Parish Boundary
County Borough Boundary (England)
Co. Boro. Bdy.
County Burgh Boundary (Scotland)
BP BS Boundary Post or Stone **P.C.B** Police Call Box
B.R. Bridle Road **P** Pump
E.P Electricity Pylon **S.P** Signal Post
F.B. Foot Bridge **SL** Sluice
F.P. Foot Path **Sp.** Spring
G.P Guide Post or Board **T.C.B** Telephone Call Box
M.S Mile Stone **Tr.** Trough
M.P M.R Mooring Post or Ring **W** Well

Ordnance Survey Plan, Additional SIMs and Supply of Unpublished Survey Information 1:2,500 and 1:1,250

Inactive Quarry, Chalk Pit or Clay Pit **Active Quarry, Chalk Pit or Clay Pit**
Rock **Boulders**
Cliff **Slopes** **Top**
Roofed Building **Glazed Roof Building**
Sloping Masonry **Archway**
Non-Coniferous Tree (surveyed) **Coniferous Tree (surveyed)**
Non-Coniferous Trees (not surveyed) **Coniferous Trees (not surveyed)**
Orchard Tree **Scrub** **Bracken**
Coppice, Osier **Reeds** **Marsh, Saltings**
Rough Grassland **Heath** **Culvert**
Direction of water flow **Bench Mark** **Antiquity (site of)**
Cave Entrance **Triangulation Station** **Electricity Pylon**
Electricity Transmission Line
County Boundary (Geographical)
County & Civil Parish Boundary
Civil Parish Boundary
Admin. County or County Bor. Boundary
London Borough Boundary
Symbol marking point where boundary mereing changes
BH Beer House **P** Pillar, Pole or Post
BP, BS Boundary Post or Stone **PO** Post Office
Cn, C Capstan, Crane **PC** Public Convenience
Chy Chimney **PH** Public House
D Fn Drinking Fountain **Pp** Pump
EI P Electricity Pillar or Post **SB, S Br** Signal Box or Bridge
FAP Fire Alarm Pillar **SP, SL** Signal Post or Light
FB Foot Bridge **Spr** Spring
GP Guide Post **Tk** Tank or Track
H Hydrant or Hydraulic **TCB** Telephone Call Box
LC Level Crossing **TCP** Telephone Call Post
MH Manhole **Tr** Trough
MP Mile Post or Mooring Post **Wr Pt, Wr T** Water Point, Water Tap
MS Mile Stone **W** Well
NTL Normal Tidal Limit **Wd Pp** Wind Pump

Large-Scale National Grid Data 1:2,500 and 1:1,250

Cliff **Slopes** **Top**
Rock **Rock (scattered)**
Boulders **Boulders (scattered)**
Positioned Boulder **Scree**
Non-Coniferous Tree (surveyed) **Coniferous Tree (surveyed)**
Non-Coniferous Trees (not surveyed) **Coniferous Trees (not surveyed)**
Orchard Tree **Scrub** **Bracken**
Coppice, Osier **Reeds** **Marsh, Saltings**
Rough Grassland **Heath** **Culvert**
Direction of water flow **Triangulation Station** **Antiquity (site of)**
Electricity Transmission Line **Electricity Pylon**
BM 231.60m Bench Mark **Buildings with Building Seed**
Roofed Building **Glazed Roof Building**
Civil parish/community boundary
District boundary
County boundary
Boundary post/stone
Boundary mereing symbol (note: these always appear in opposed pairs or groups of three)
Bks Barracks **P** Pillar, Pole or Post
Bty Battery **PO** Post Office
Cemy Cemetery **PC** Public Convenience
Chy Chimney **Pp** Pump
Cis Cistern **Ppg Sta** Pumping Station
Dismtd Rly Dismantled Railway **PW** Place of Worship
EI Gen Sta Electricity Generating Station **Sewage Ppg Sta** Sewage Pumping Station
EI P Electricity Pole, Pillar **SB, S Br** Signal Box or Bridge
EI Sub Sta Electricity Sub Station **SP, SL** Signal Post or Light
FB Filter Bed **Spr** Spring
Fn / D Fn Fountain / Drinking Ftn. **Tk** Tank or Track
Gas Gov Gas Valve Compound **Tr** Trough
GVC Gas Governor **Wd Pp** Wind Pump
GP Guide Post **Wr Pt, Wr T** Water Point, Water Tap
MH Manhole **Wks** Works (building or area)
MP, MS Mile Post or Mile Stone **W** Well

Historical Mapping & Photography included:

Mapping Type	Scale	Date	Pg
Lincolnshire	1:2,500	1886	2
Lincolnshire	1:2,500	1906	3
Ordnance Survey Plan	1:2,500	1974	4
Large-Scale National Grid Data	1:2,500	1994	5

Historical Map - Segment D6

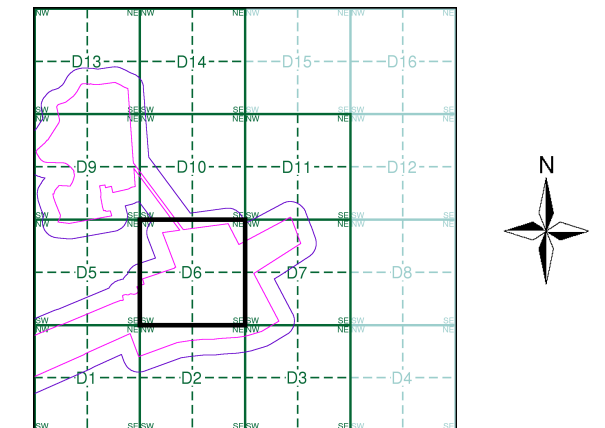

Order Details

Order Number: 298001007_1_1
 Customer Ref: 21-1098.04
 National Grid Reference: 491280, 377900
 Slice: D
 Site Area (Ha): 471.82
 Search Buffer (m): 100

Site Details

West Barton 1

Lincolnshire

Published 1886

Source map scale - 1:2,500

The historical maps shown were reproduced from maps predominantly held at the scale adopted for England, Wales and Scotland in the 1840's. In 1854 the 1:2,500 scale was adopted for mapping urban areas and by 1896 it covered the whole of what were considered to be the cultivated parts of Great Britain. The published date given below is often some years later than the surveyed date. Before 1938, all OS maps were based on the Cassini Projection, with independent surveys of a single county or group of counties, giving rise to significant inaccuracies in outlying areas.

Map Name(s) and Date(s)

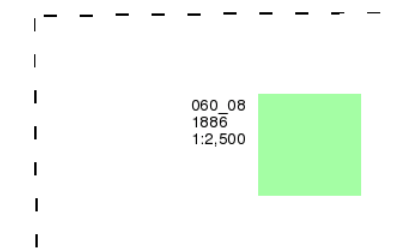

Historical Map - Segment D6

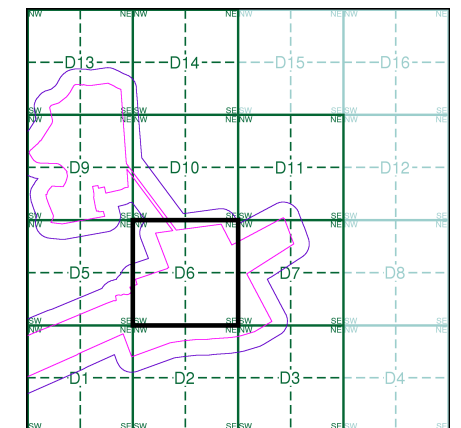

Order Details

Order Number: 298001007_1_1
 Customer Ref: 21-1098.04
 National Grid Reference: 491280, 377900
 Slice: D
 Site Area (Ha): 471.82
 Search Buffer (m): 100

Site Details

West Barton 1

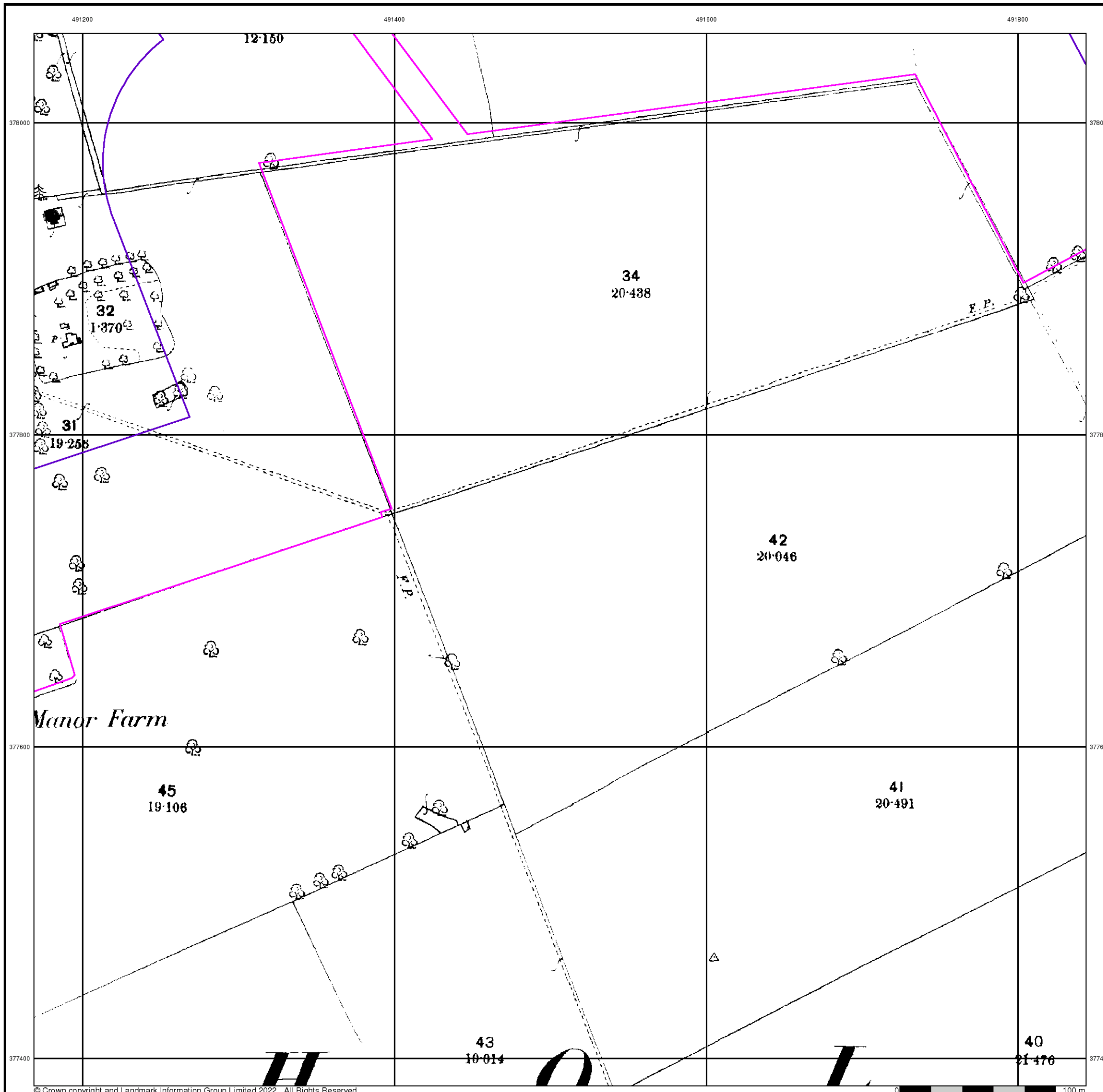

Lincolnshire

Published 1906

Source map scale - 1:2,500

The historical maps shown were reproduced from maps predominantly held at the scale adopted for England, Wales and Scotland in the 1840's. In 1854 the 1:2,500 scale was adopted for mapping urban areas and by 1896 it covered the whole of what were considered to be the cultivated parts of Great Britain. The published date given below is often some years later than the surveyed date. Before 1938, all OS maps were based on the Cassini Projection, with independent surveys of a single county or group of counties, giving rise to significant inaccuracies in outlying areas.

Map Name(s) and Date(s)

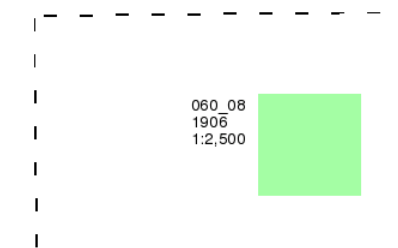

Historical Map - Segment D6

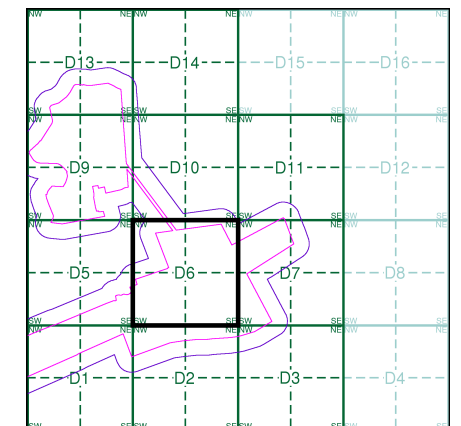

Order Details

Order Number: 298001007_1_1
 Customer Ref: 21-1098.04
 National Grid Reference: 491280, 377900
 Slice: D
 Site Area (Ha): 471.82
 Search Buffer (m): 100

Site Details

West Barton 1

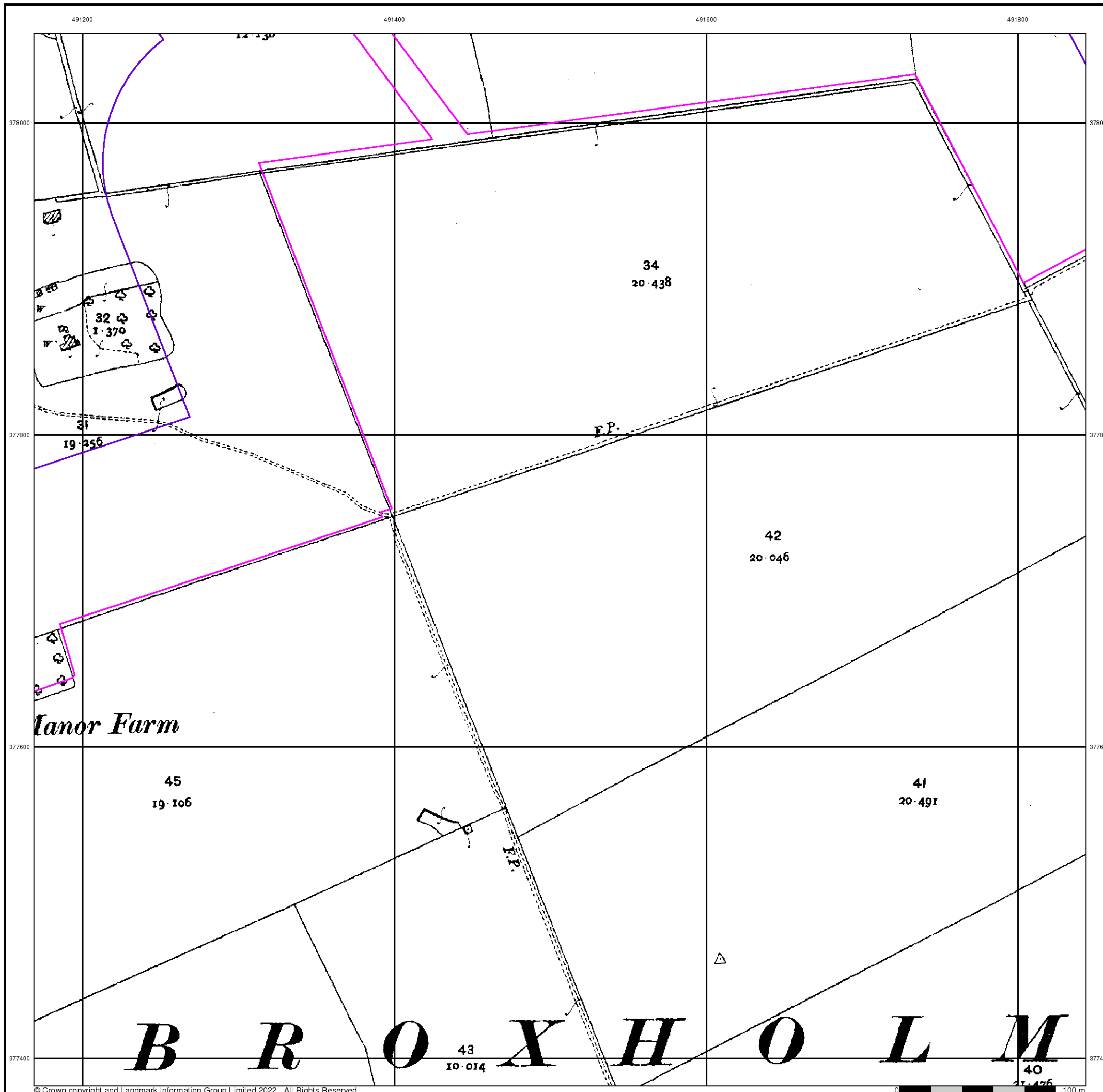

Ordnance Survey Plan

Published 1974

Source map scale - 1:2,500

The historical maps shown were reproduced from maps predominantly held at the scale adopted for England, Wales and Scotland in the 1840's. In 1854 the 1:2,500 scale was adopted for mapping urban areas and by 1896 it covered the whole of what were considered to be the cultivated parts of Great Britain. The published date given below is often some years later than the surveyed date. Before 1938, all OS maps were based on the Cassini Projection, with independent surveys of a single county or group of counties, giving rise to significant inaccuracies in outlying areas.

Map Name(s) and Date(s)

SK9178
1974
1:2,500
SK9177
1974
1:2,500

Historical Map - Segment D6

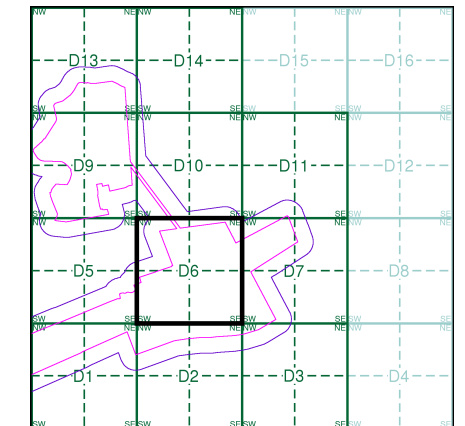

Order Details

Order Number: 298001007_1_1
 Customer Ref: 21-1098.04
 National Grid Reference: 491280, 377900
 Slice: D
 Site Area (Ha): 471.82
 Search Buffer (m): 100

Site Details

West Barton 1

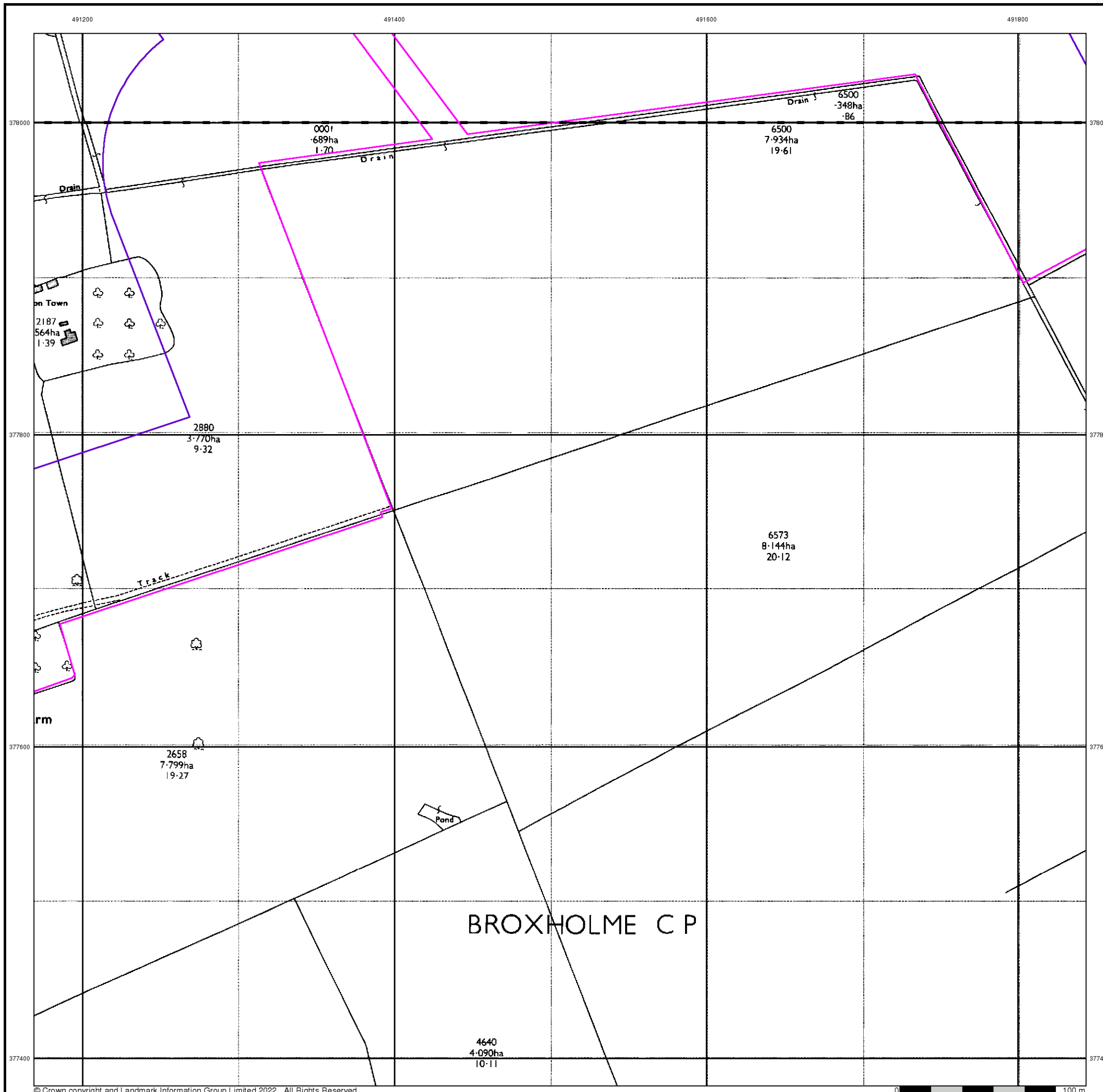

Large-Scale National Grid Data

Published 1994

Source map scale - 1:2,500

'Large Scale National Grid Data' superseded SIM cards (Ordnance Survey's 'Survey of Information on Microfilm') in 1992, and continued to be produced until 1999. These maps were the fore-runners of digital mapping and so provide detailed information on houses and roads, but tend to show less topographic features such as vegetation. These maps were produced at both 1:2,500 and 1:1,250 scales.

Map Name(s) and Date(s)

SK9178	1994	1:2,500
SK9177	1994	1:2,500

Historical Map - Segment D6

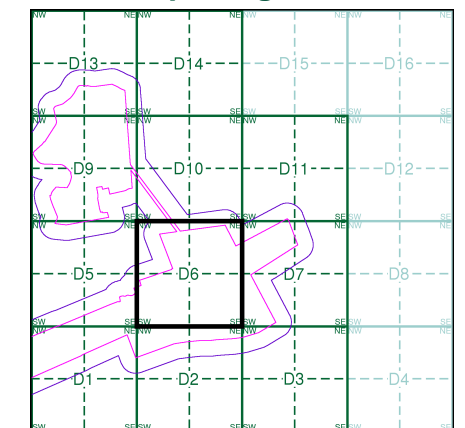

Order Details

Order Number: 298001007_1_1
 Customer Ref: 21-1098.04
 National Grid Reference: 491280, 377900
 Slice: D
 Site Area (Ha): 471.82
 Search Buffer (m): 100

Site Details

West Barton 1

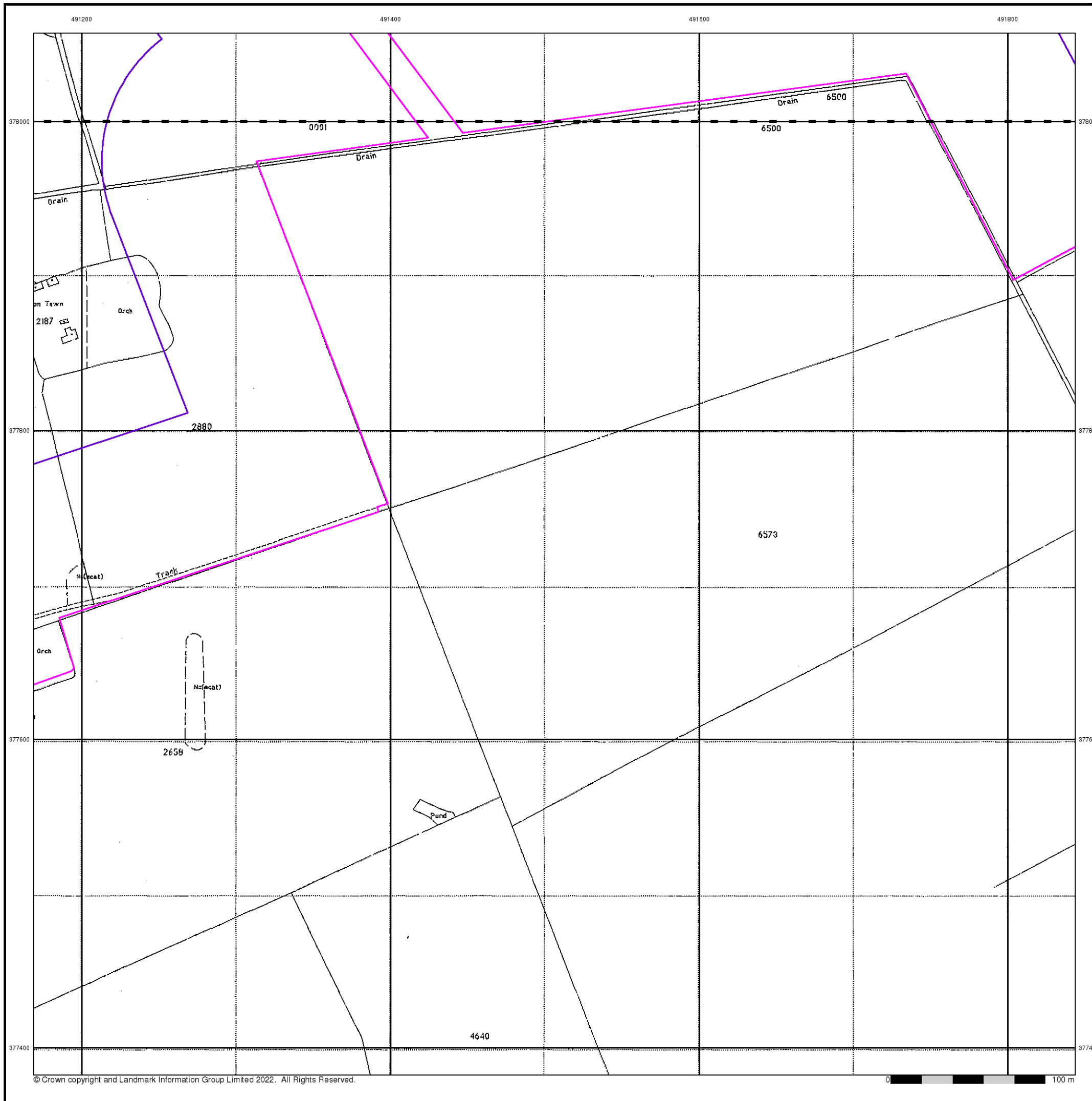

Historical Mapping Legends

Ordnance Survey County Series and Ordnance Survey Plan 1:2,500

Quarry **Gravel Pit** **Sand Pit**
Clay Pit **Shingle** **Refuse Heap**
Sloping Masonry **Flat Rock**
Marsh **Reeds** **Osiers**
Rough Pasture **Furze** **Wood**
Mixed Wood **Brushwood** **Orchard**
Fir **Ford** **Stepping Stones**
Ferry **Waterfall** **Lock**
Trig. Station **Altitude at Trig. Station**
B.M. 325.9 **Bench Mark** **Surface Level**
Arrow denotes flow of water **Antiquities (site of)**
Cutting **Embankment**
Railway crossing Road **Level Crossing** **Road crossing Railway**
Railway crossing River or Canal **Road over single stream** **Road over River or Canal**
County Boundary (Geographical)
County & Civil Parish Boundary
Administrative County & Civil Parish Boundary
County Borough Boundary (England)
County Burgh Boundary (Scotland)
Boundary Post or Stone **Police Call Box**
B.R. Bridle Road **Pump**
E.P. Electricity Pylon **S.P. Signal Post**
F.B. Foot Bridge **Sl. Sluice**
F.P. Foot Path **Sp. Spring**
G.P. Guide Post or Board **T.C.B. Telephone Call Box**
M.S. Mile Stone **Tr. Trough**
M.P. M.R. Mooring Post or Ring **W. Well**

Ordnance Survey Plan, Additional SIMs and Supply of Unpublished Survey Information 1:2,500 and 1:1,250

Inactive Quarry, Chalk Pit or Clay Pit **Active Quarry, Chalk Pit or Clay Pit**
Rock **Boulders**
Cliff **Slopes** **Top**
Roofed Building **Glazed Roof Building**
Sloping Masonry **Archway**
Non-Coniferous Tree (surveyed) **Coniferous Tree (surveyed)**
Non-Coniferous Trees (not surveyed) **Coniferous Trees (not surveyed)**
Orchard Tree **Scrub** **Bracken**
Coppice, Osier **Reeds** **Marsh, Saltings**
Rough Grassland **Heath** **Culvert**
Direction of water flow **Bench Mark** **Antiquity (site of)**
Cave Entrance **Triangulation Station** **Electricity Pylon**
Electricity Transmission Line
County Boundary (Geographical)
County & Civil Parish Boundary
Civil Parish Boundary
Admin. County or County Bor. Boundary
London Borough Boundary
Symbol marking point where boundary mereing changes
BH Beer House **P Pillar, Pole or Post**
BP, BS Boundary Post or Stone **PO Post Office**
Cn, C Capstan, Crane **PC Public Convenience**
Chy Chimney **PH Public House**
D Fn Drinking Fountain **Pp Pump**
EI P Electricity Pillar or Post **SB, S Br Signal Box or Bridge**
FAP Fire Alarm Pillar **SP, SL Signal Post or Light**
FB Foot Bridge **Spr Spring**
GP Guide Post **Tk Tank or Track**
H Hydrant or Hydraulic **TCB Telephone Call Box**
LC Level Crossing **TCP Telephone Call Post**
MH Manhole **Tr Trough**
MP Mile Post or Mooring Post **Wr Pt, Wr T Water Point, Water Tap**
MS Mile Stone **W Well**
NTL Normal Tidal Limit **Wd Pp Wind Pump**

Large-Scale National Grid Data 1:2,500 and 1:1,250

Cliff **Slopes** **Top**
Rock **Rock (scattered)**
Boulders **Boulders (scattered)**
Positioned Boulder **Scree**
Non-Coniferous Tree (surveyed) **Coniferous Tree (surveyed)**
Non-Coniferous Trees (not surveyed) **Coniferous Trees (not surveyed)**
Orchard Tree **Scrub** **Bracken**
Coppice, Osier **Reeds** **Marsh, Saltings**
Rough Grassland **Heath** **Culvert**
Direction of water flow **Triangulation Station** **Antiquity (site of)**
Electricity Transmission Line **Electricity Pylon**
Bench Mark **Buildings with Building Seed**
Roofed Building **Glazed Roof Building**
Civil parish/community boundary
District boundary
County boundary
Boundary post/stone
Boundary mereing symbol (note: these always appear in opposed pairs or groups of three)
Bks Barracks **P Pillar, Pole or Post**
Bty Battery **PO Post Office**
Cemy Cemetery **PC Public Convenience**
Chy Chimney **Pp Pump**
Cis Cistern **Ppg Sta Pumping Station**
Dismtd Rly Dismantled Railway **PW Place of Worship**
EI Gen Sta Electricity Generating Station **Sewage Ppg Sta Sewage Pumping Station**
EI P Electricity Pole, Pillar **SB, S Br Signal Box or Bridge**
EI Sub Sta Electricity Sub Station **SP, SL Signal Post or Light**
FB Filter Bed **Spr Spring**
Fn / D Fn Fountain / Drinking Ftn. **Tk Tank or Track**
Gas Gov Gas Valve Compound **Tr Trough**
GVC Gas Governor **Wd Pp Wind Pump**
GP Guide Post **Wr Pt, Wr T Water Point, Water Tap**
MH Manhole **Wks Works (building or area)**
MP, MS Mile Post or Mile Stone **W Well**

Historical Mapping & Photography included:

Mapping Type	Scale	Date	Pg
Lincolnshire	1:2,500	1886	2
Lincolnshire	1:2,500	1906	3
Ordnance Survey Plan	1:2,500	1973 - 1974	4
Large-Scale National Grid Data	1:2,500	1994	5

Historical Map - Segment D7

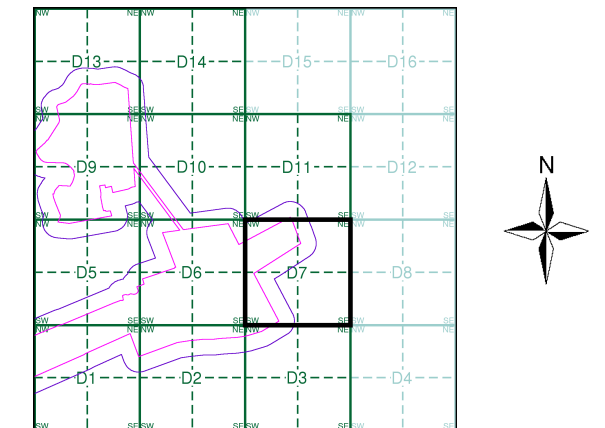

Order Details

Order Number: 298001007_1_1
 Customer Ref: 21-1098.04
 National Grid Reference: 491280, 377900
 Slice: D
 Site Area (Ha): 471.82
 Search Buffer (m): 100

Site Details

West Barton 1

Lincolnshire

Published 1886

Source map scale - 1:2,500

The historical maps shown were reproduced from maps predominantly held at the scale adopted for England, Wales and Scotland in the 1840's. In 1854 the 1:2,500 scale was adopted for mapping urban areas and by 1896 it covered the whole of what were considered to be the cultivated parts of Great Britain. The published date given below is often some years later than the surveyed date. Before 1938, all OS maps were based on the Cassini Projection, with independent surveys of a single county or group of counties, giving rise to significant inaccuracies in outlying areas.

Map Name(s) and Date(s)

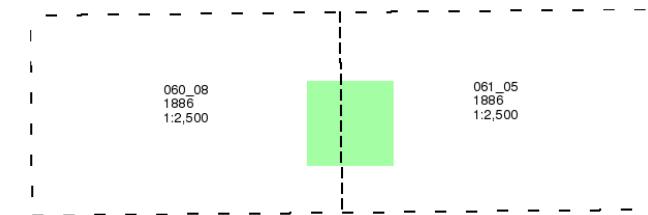

Historical Map - Segment D7

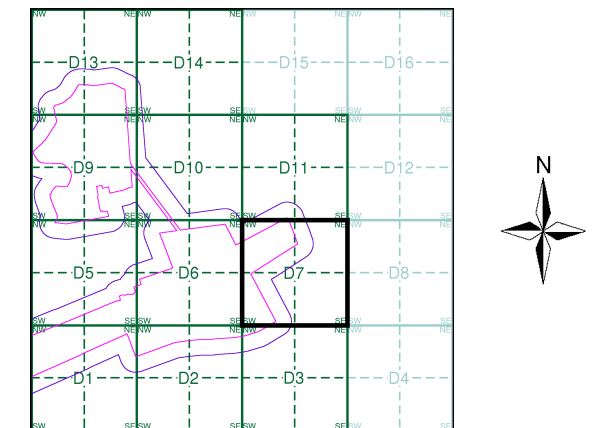

Order Details

Order Number: 298001007_1_1
 Customer Ref: 21-1098.04
 National Grid Reference: 491280, 377900
 Slice: D
 Site Area (Ha): 471.82
 Search Buffer (m): 100

Site Details

West Barton 1

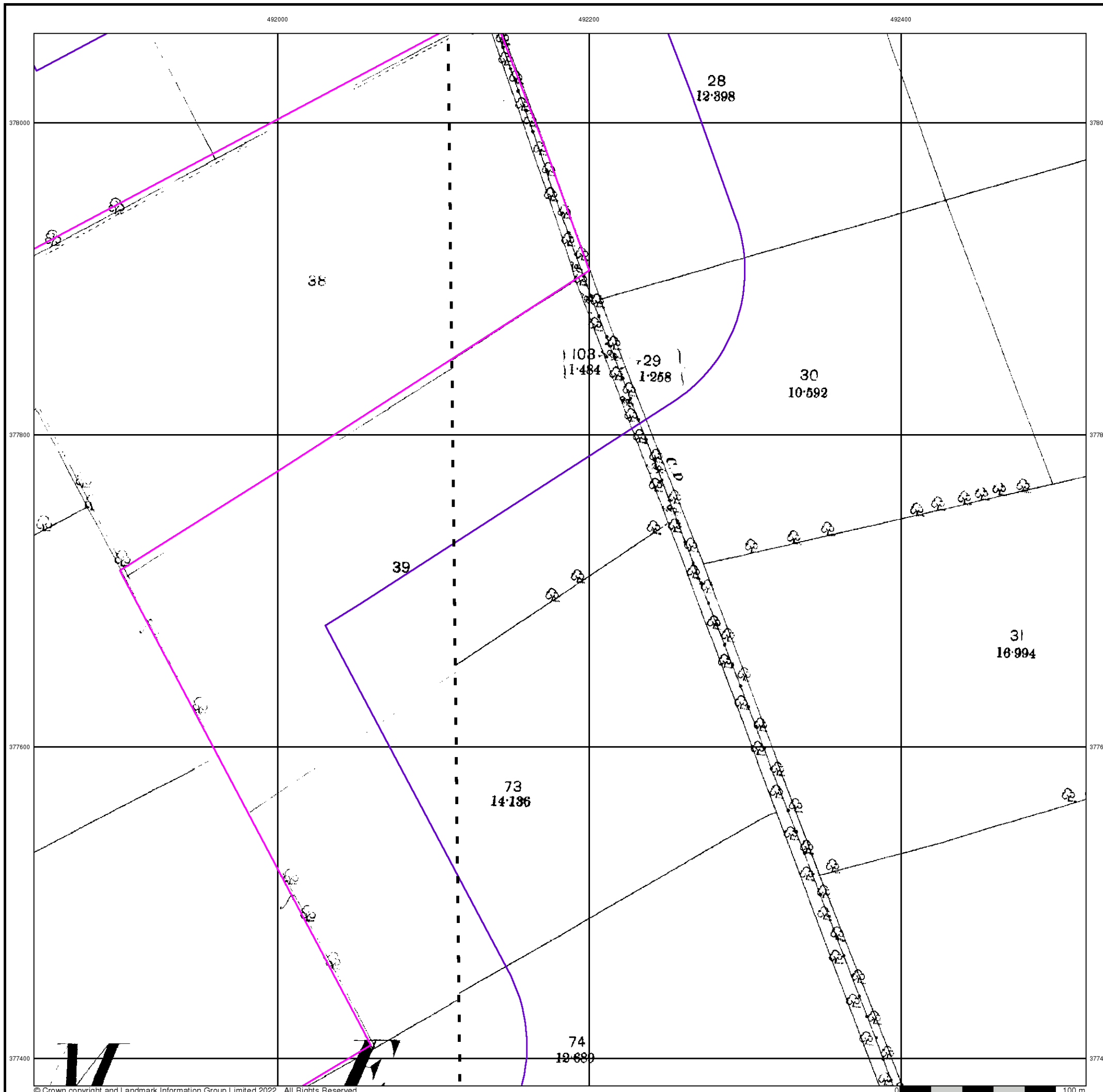

Lincolnshire

Published 1906

Source map scale - 1:2,500

The historical maps shown were reproduced from maps predominantly held at the scale adopted for England, Wales and Scotland in the 1840's. In 1854 the 1:2,500 scale was adopted for mapping urban areas and by 1896 it covered the whole of what were considered to be the cultivated parts of Great Britain. The published date given below is often some years later than the surveyed date. Before 1938, all OS maps were based on the Cassini Projection, with independent surveys of a single county or group of counties, giving rise to significant inaccuracies in outlying areas.

Map Name(s) and Date(s)

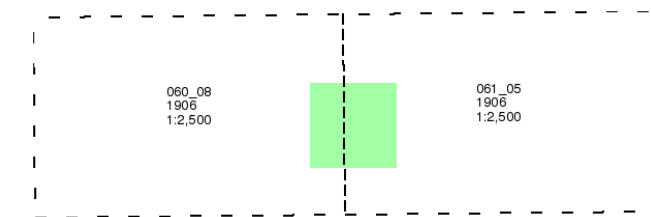

Historical Map - Segment D7

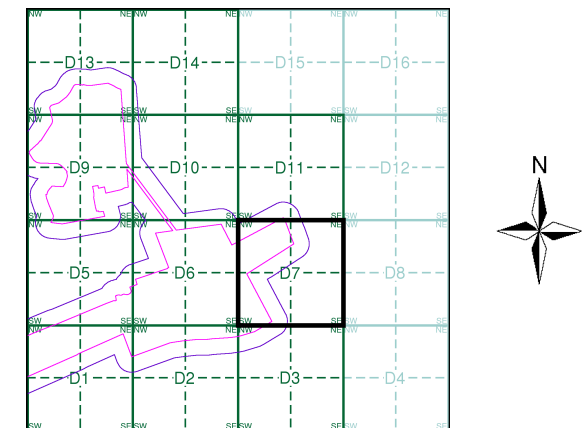

Order Details

Order Number: 298001007_1_1
 Customer Ref: 21-1098.04
 National Grid Reference: 491280, 377900
 Slice: D
 Site Area (Ha): 471.82
 Search Buffer (m): 100

Site Details

West Barton 1

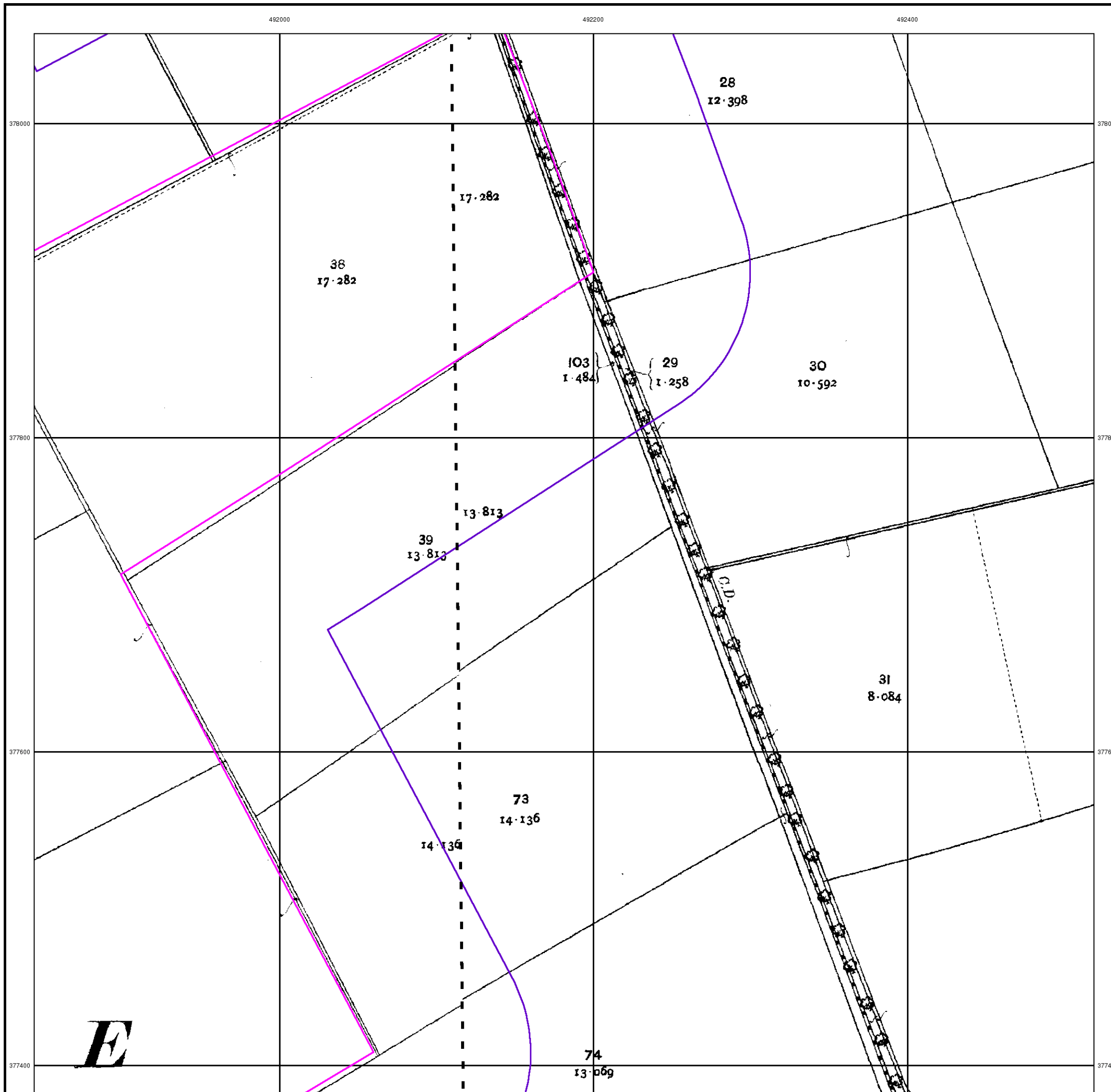

Ordnance Survey Plan
Published 1973 - 1974
Source map scale - 1:2,500

The historical maps shown were reproduced from maps predominantly held at the scale adopted for England, Wales and Scotland in the 1840's. In 1854 the 1:2,500 scale was adopted for mapping urban areas and by 1896 it covered the whole of what were considered to be the cultivated parts of Great Britain. The published date given below is often some years later than the surveyed date. Before 1938, all OS maps were based on the Cassini Projection, with independent surveys of a single county or group of counties, giving rise to significant inaccuracies in outlying areas.

Map Name(s) and Date(s)

SK9178 1974 1:2,500	SK9278 1974 1:2,500
SK9177 1974 1:2,500	SK9277 1973 1:2,500

Historical Map - Segment D7

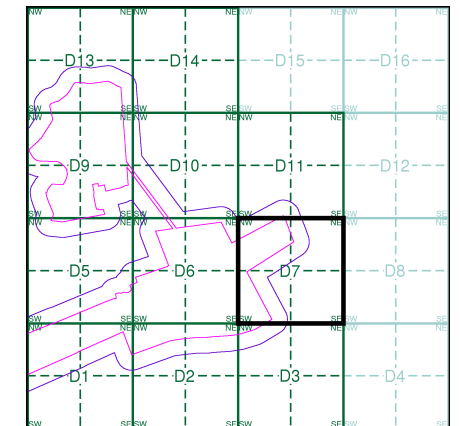

Order Details

Order Number: 298001007_1_1
 Customer Ref: 21-1098.04
 National Grid Reference: 491280, 377900
 Slice: D
 Site Area (Ha): 471.82
 Search Buffer (m): 100

Site Details

West Barton 1

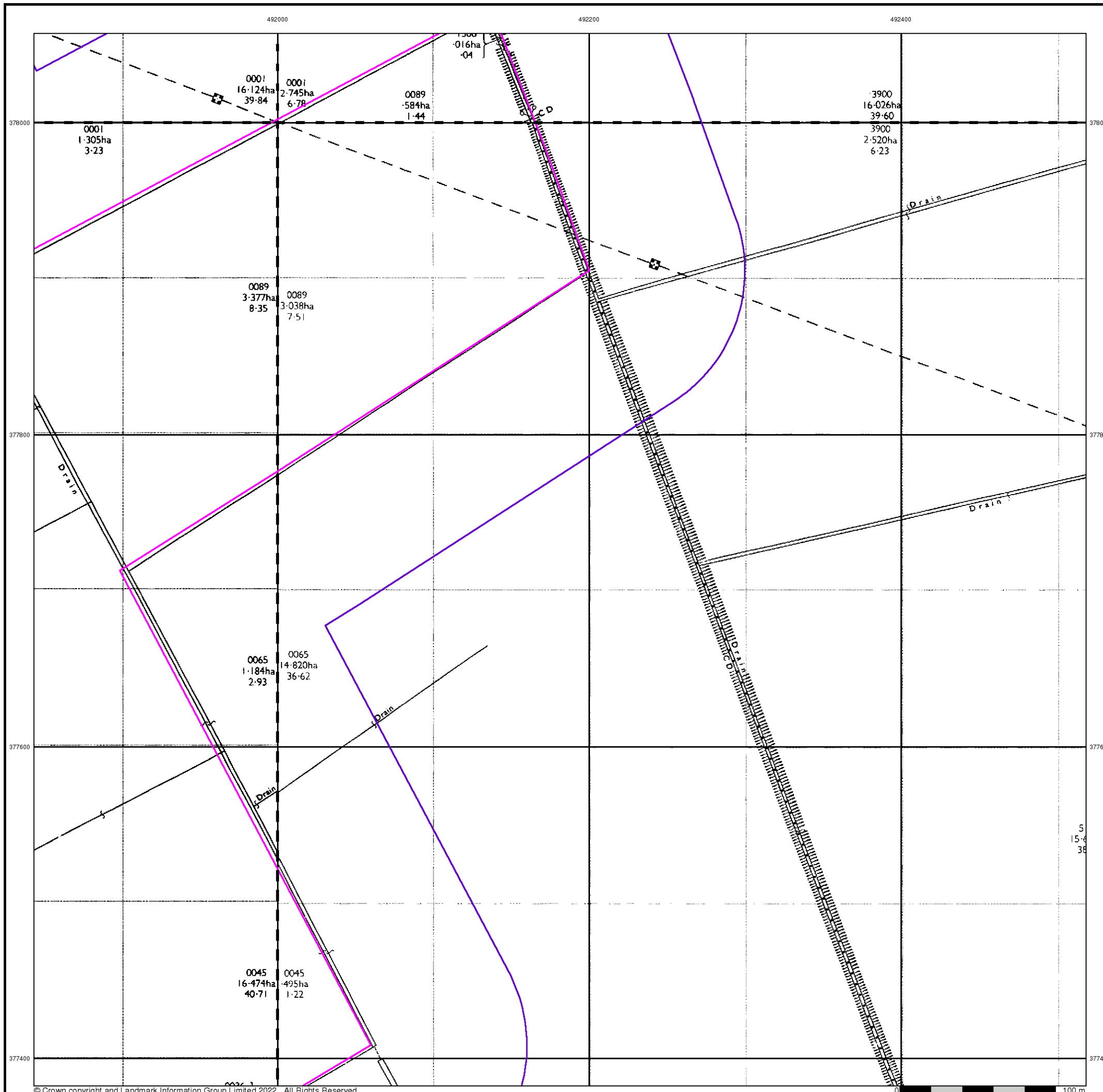

Large-Scale National Grid Data

Published 1994

Source map scale - 1:2,500

'Large Scale National Grid Data' superseded SIM cards (Ordnance Survey's 'Survey of Information on Microfilm') in 1992, and continued to be produced until 1999. These maps were the fore-runners of digital mapping and so provide detailed information on houses and roads, but tend to show less topographic features such as vegetation. These maps were produced at both 1:2,500 and 1:1,250 scales.

Map Name(s) and Date(s)

SK9178 1994 1:2,500	SK9278 1994 1:2,500
SK9177 1994 1:2,500	SK9277 1994 1:2,500

Historical Map - Segment D7

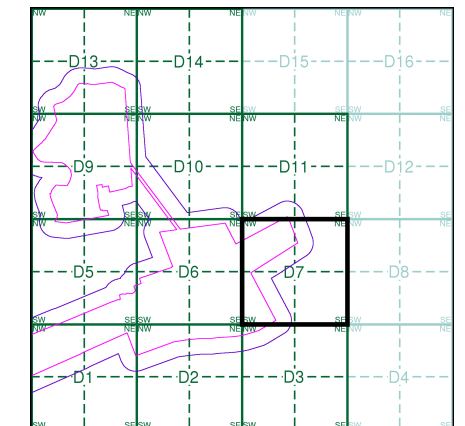

Order Details

Order Number: 298001007_1_1
 Customer Ref: 21-1098.04
 National Grid Reference: 491280, 377900
 Slice: D
 Site Area (Ha): 471.82
 Search Buffer (m): 100

Site Details

West Barton 1

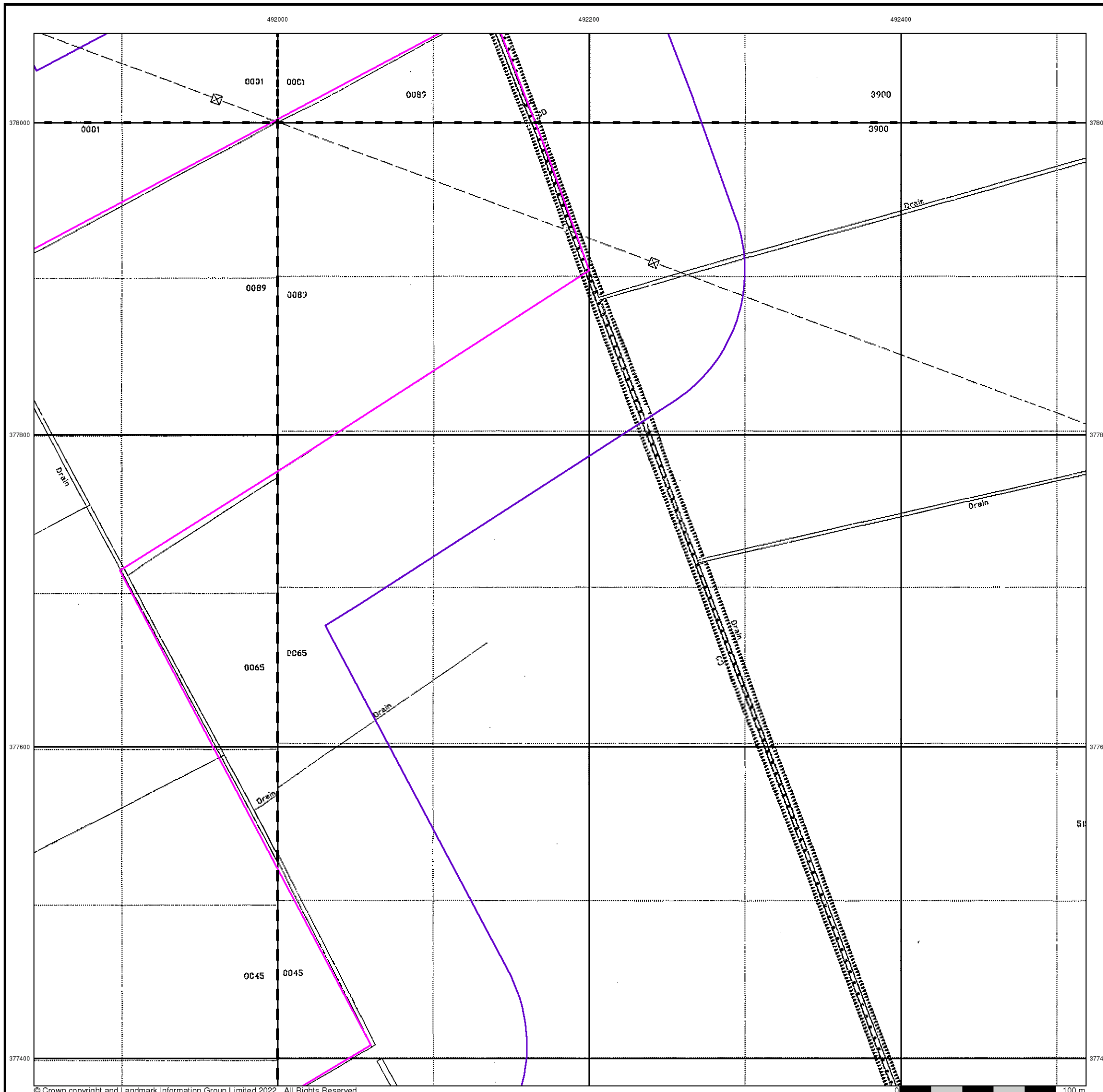

Historical Mapping Legends

Ordnance Survey County Series and Ordnance Survey Plan 1:2,500

Quarry **Gravel Pit** **Sand Pit**
Clay Pit **Shingle** **Refuse Heap**
Sloping Masonry **Flat Rock**
Marsh **Reeds** **Osiers**
Rough Pasture **Furze** **Wood**
Mixed Wood **Brushwood** **Orchard**
Fir **Ford** **Stepping Stones**
Ferry **Waterfall** **Lock**
Trig. Station **Altitude at Trig. Station**
B.M. 325.9 **Bench Mark** **Surface Level**
Arrow denotes flow of water **Antiquities (site of)**
Cutting **Embankment**
Railway crossing Road **Level Crossing** **Road crossing Railway**
Railway crossing River or Canal **Road over single stream** **Road over River or Canal**
County Boundary (Geographical)
County & Civil Parish Boundary
Administrative County & Civil Parish Boundary
County Borough Boundary (England)
County Burgh Boundary (Scotland)
Co. Boro. Bdy.
Co. Burgh Bdy.
BP BS Boundary Post or Stone **P.C.B** Police Call Box
B.R. Bridle Road **P** Pump
E.P Electricity Pylon **S.P** Signal Post
F.B. Foot Bridge **SL** Sluice
F.P. Foot Path **Sp.** Spring
G.P Guide Post or Board **T.C.B** Telephone Call Box
M.S Mile Stone **Tr.** Trough
M.P M.R Mooring Post or Ring **W** Well

Ordnance Survey Plan, Additional SIMs and Supply of Unpublished Survey Information 1:2,500 and 1:1,250

Inactive Quarry, Chalk Pit or Clay Pit **Active Quarry, Chalk Pit or Clay Pit**
Rock **Boulders**
Cliff **Slopes** **Top**
Roofed Building **Glazed Roof Building**
Sloping Masonry **Archway**
Non-Coniferous Tree (surveyed) **Coniferous Tree (surveyed)**
Non-Coniferous Trees (not surveyed) **Coniferous Trees (not surveyed)**
Orchard Tree **Scrub** **Bracken**
Coppice, Osier **Reeds** **Marsh, Saltings**
Rough Grassland **Heath** **Culvert**
Direction of water flow **Bench Mark** **Antiquity (site of)**
Cave Entrance **Triangulation Station** **Electricity Pylon**
Electricity Transmission Line
County Boundary (Geographical)
County & Civil Parish Boundary
Civil Parish Boundary
Admin. County or County Bor. Boundary
London Borough Boundary
Symbol marking point where boundary mereing changes
BH Beer House **P** Pillar, Pole or Post
BP, BS Boundary Post or Stone **PO** Post Office
Cn, C Capstan, Crane **PC** Public Convenience
Chy Chimney **PH** Public House
D Fn Drinking Fountain **Pp** Pump
EI P Electricity Pillar or Post **SB, S Br** Signal Box or Bridge
FAP Fire Alarm Pillar **SP, SL** Signal Post or Light
FB Foot Bridge **Spr** Spring
GP Guide Post **Tk** Tank or Track
H Hydrant or Hydraulic **TCB** Telephone Call Box
LC Level Crossing **TCP** Telephone Call Post
MH Manhole **Tr** Trough
MP Mile Post or Mooring Post **Wr Pt, Wr T** Water Point, Water Tap
MS Mile Stone **W** Well
NTL Normal Tidal Limit **Wd Pp** Wind Pump

Large-Scale National Grid Data 1:2,500 and 1:1,250

Cliff **Slopes** **Top**
Rock **Rock (scattered)**
Boulders **Boulders (scattered)**
Positioned Boulder **Scree**
Non-Coniferous Tree (surveyed) **Coniferous Tree (surveyed)**
Non-Coniferous Trees (not surveyed) **Coniferous Trees (not surveyed)**
Orchard Tree **Scrub** **Bracken**
Coppice, Osier **Reeds** **Marsh, Saltings**
Rough Grassland **Heath** **Culvert**
Direction of water flow **Triangulation Station** **Antiquity (site of)**
Electricity Transmission Line **Electricity Pylon**
B.M. 231.60m Bench Mark **Buildings with Building Seed**
Roofed Building **Glazed Roof Building**
Civil parish/community boundary
District boundary
County boundary
Boundary post/stone
Boundary mereing symbol (note: these always appear in opposed pairs or groups of three)
Bks Barracks **P** Pillar, Pole or Post
Bty Battery **PO** Post Office
Cemy Cemetery **PC** Public Convenience
Chy Chimney **Pp** Pump
Cis Cistern **Ppg Sta** Pumping Station
Dismtd Rly Dismantled Railway **PW** Place of Worship
EI Gen Sta Electricity Generating Station **Sewage Ppg Sta** Sewage Pumping Station
EI P Electricity Pole, Pillar **SB, S Br** Signal Box or Bridge
EI Sub Sta Electricity Sub Station **SP, SL** Signal Post or Light
FB Filter Bed **Spr** Spring
Fn / D Fn Fountain / Drinking Ftn. **Tk** Tank or Track
Gas Gov Gas Valve Compound **Tr** Trough
GVC Gas Governor **Wd Pp** Wind Pump
GP Guide Post **Wr Pt, Wr T** Water Point, Water Tap
MH Manhole **Wks** Works (building or area)
MP, MS Mile Post or Mile Stone **W** Well

Historical Mapping & Photography included:

Mapping Type	Scale	Date	Pg
Lincolnshire	1:2,500	1886	2
Lincolnshire	1:2,500	1906	3
Ordnance Survey Plan	1:2,500	1974	4
Large-Scale National Grid Data	1:2,500	1994	5

Historical Map - Segment D9

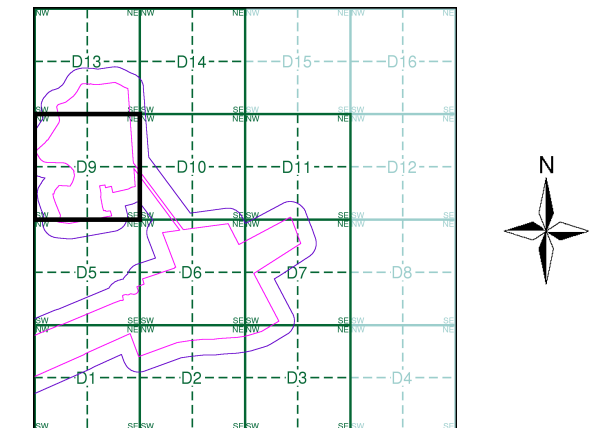

Order Details

Order Number: 298001007_1_1
 Customer Ref: 21-1098.04
 National Grid Reference: 491280, 377900
 Slice: D
 Site Area (Ha): 471.82
 Search Buffer (m): 100

Site Details

West Barton 1

Lincolnshire

Published 1886

Source map scale - 1:2,500

The historical maps shown were reproduced from maps predominantly held at the scale adopted for England, Wales and Scotland in the 1840's. In 1854 the 1:2,500 scale was adopted for mapping urban areas and by 1896 it covered the whole of what were considered to be the cultivated parts of Great Britain. The published date given below is often some years later than the surveyed date. Before 1938, all OS maps were based on the Cassini Projection, with independent surveys of a single county or group of counties, giving rise to significant inaccuracies in outlying areas.

Map Name(s) and Date(s)

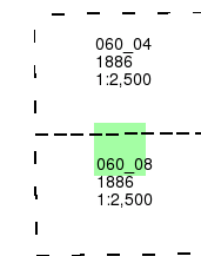

Historical Map - Segment D9

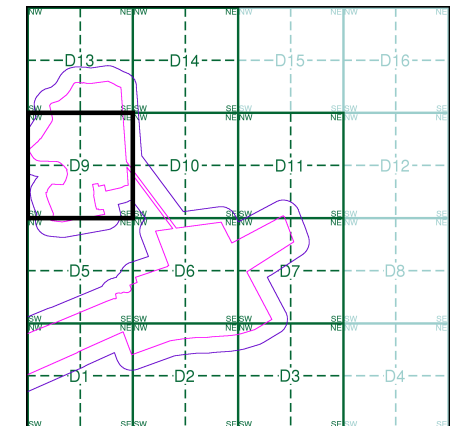

Order Details

Order Number: 298001007_1_1
 Customer Ref: 21-1098.04
 National Grid Reference: 491280, 377900
 Slice: D
 Site Area (Ha): 471.82
 Search Buffer (m): 100

Site Details

West Barton 1

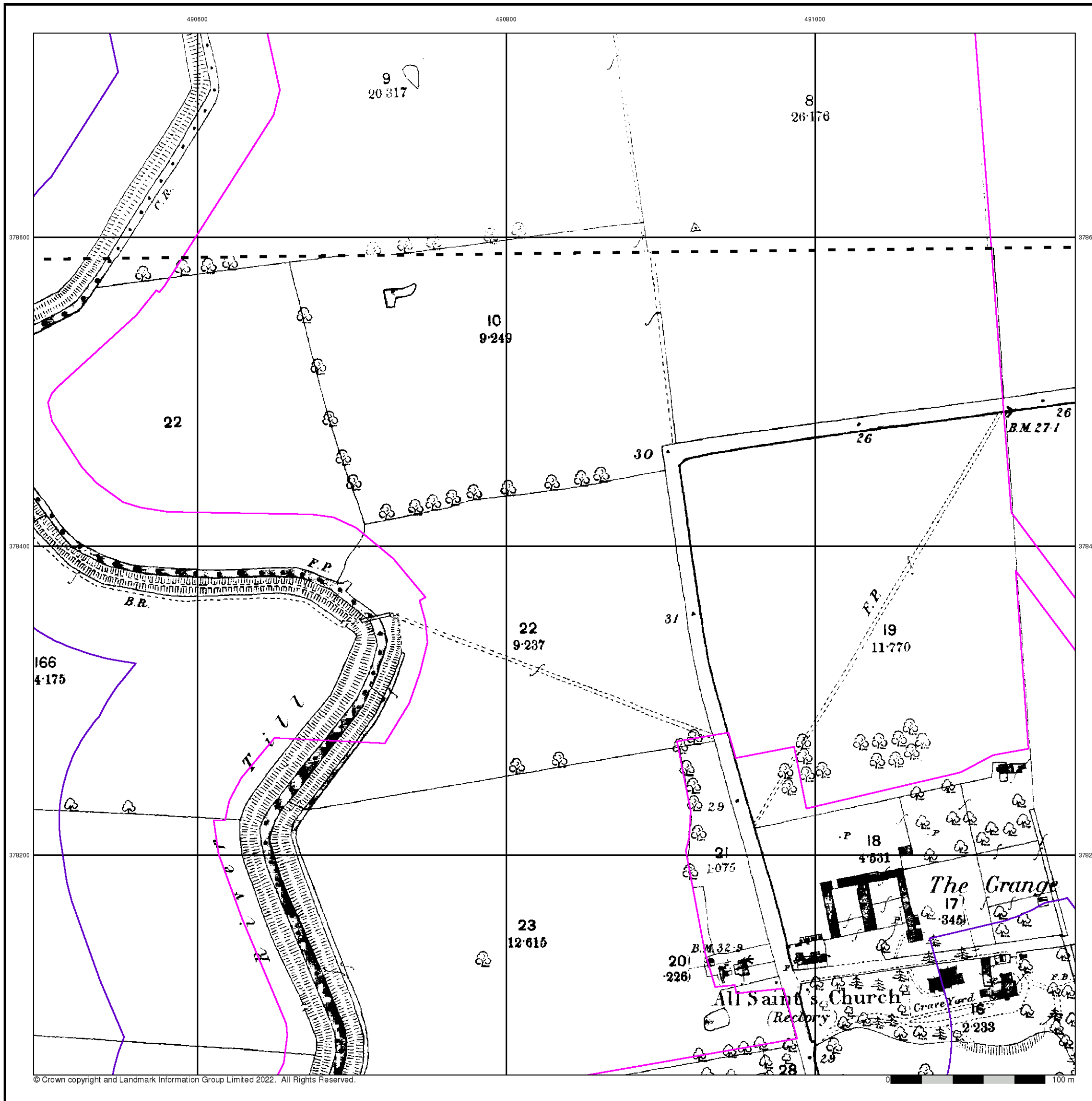

Lincolnshire

Published 1906

Source map scale - 1:2,500

The historical maps shown were reproduced from maps predominantly held at the scale adopted for England, Wales and Scotland in the 1840's. In 1854 the 1:2,500 scale was adopted for mapping urban areas and by 1896 it covered the whole of what were considered to be the cultivated parts of Great Britain. The published date given below is often some years later than the surveyed date. Before 1938, all OS maps were based on the Cassini Projection, with independent surveys of a single county or group of counties, giving rise to significant inaccuracies in outlying areas.

Map Name(s) and Date(s)

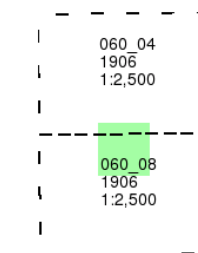

Historical Map - Segment D9

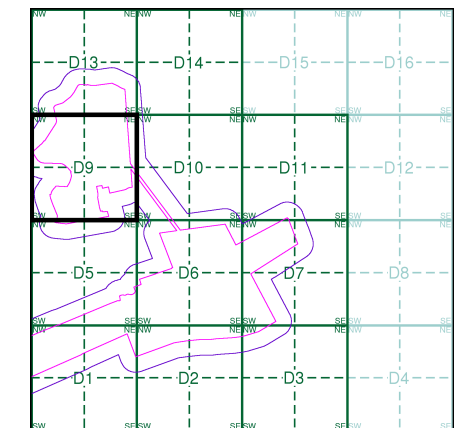

Order Details

Order Number: 298001007_1_1
 Customer Ref: 21-1098.04
 National Grid Reference: 491280, 377900
 Slice: D
 Site Area (Ha): 471.82
 Search Buffer (m): 100

Site Details

West Barton 1

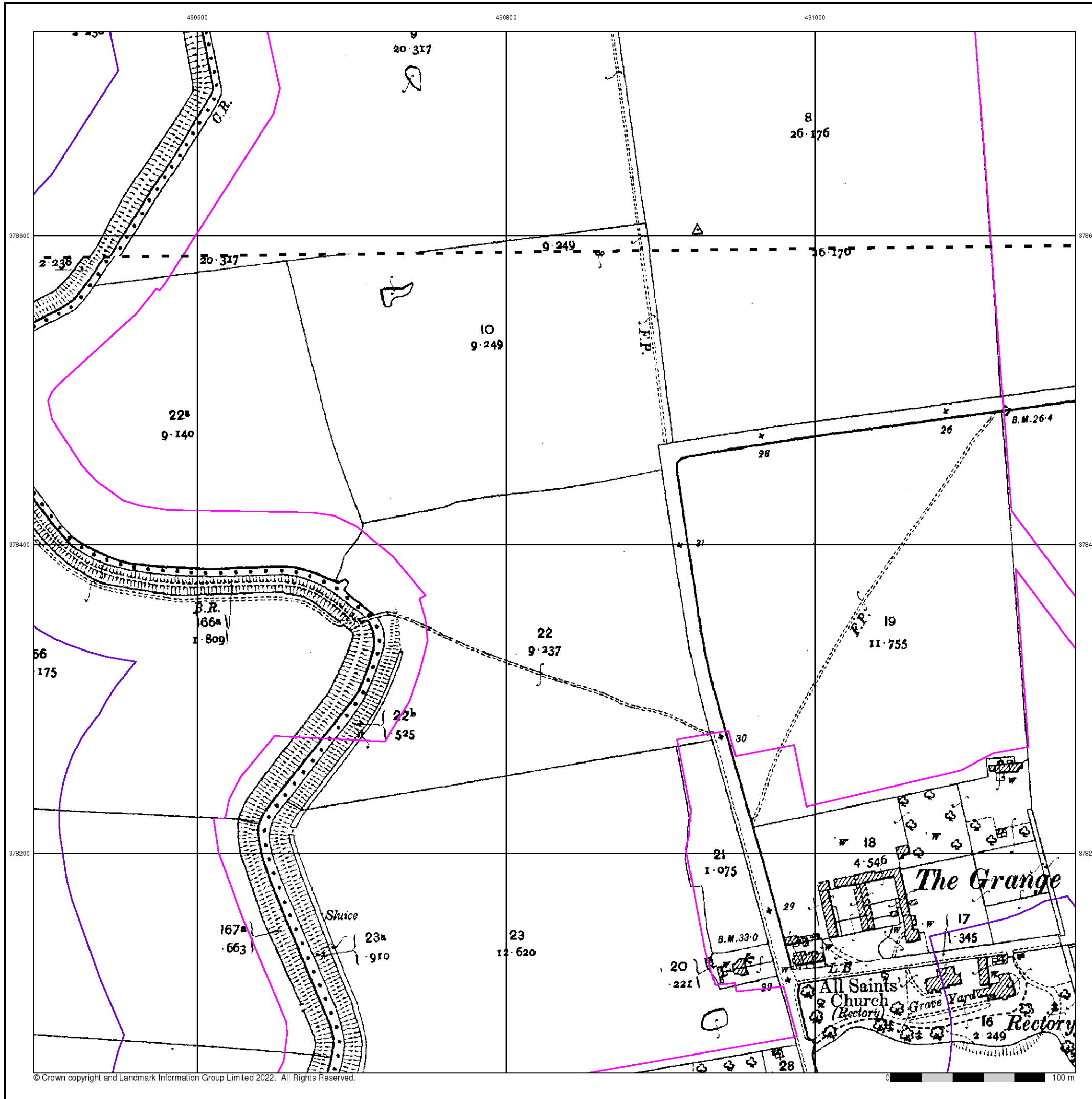

Ordnance Survey Plan
Published 1974
Source map scale - 1:2,500

The historical maps shown were reproduced from maps predominantly held at the scale adopted for England, Wales and Scotland in the 1840's. In 1854 the 1:2,500 scale was adopted for mapping urban areas and by 1896 it covered the whole of what were considered to be the cultivated parts of Great Britain. The published date given below is often some years later than the surveyed date. Before 1938, all OS maps were based on the Cassini Projection, with independent surveys of a single county or group of counties, giving rise to significant inaccuracies in outlying areas.

Map Name(s) and Date(s)

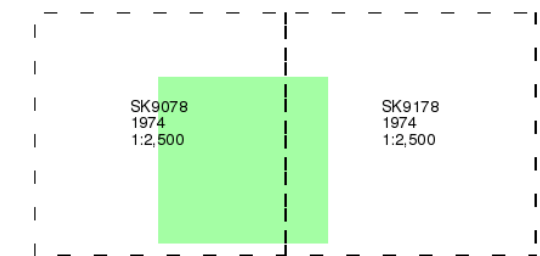

Historical Map - Segment D9

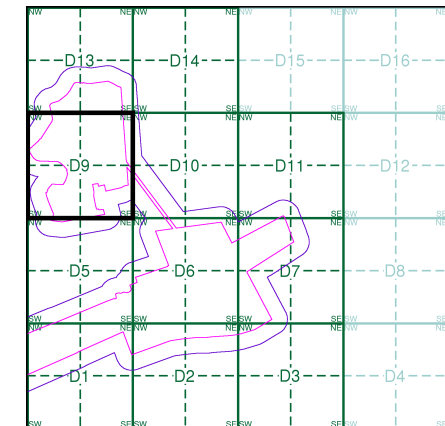

Order Details

Order Number: 298001007_1_1
 Customer Ref: 21-1098.04
 National Grid Reference: 491280, 377900
 Slice: D
 Site Area (Ha): 471.82
 Search Buffer (m): 100

Site Details

West Barton 1

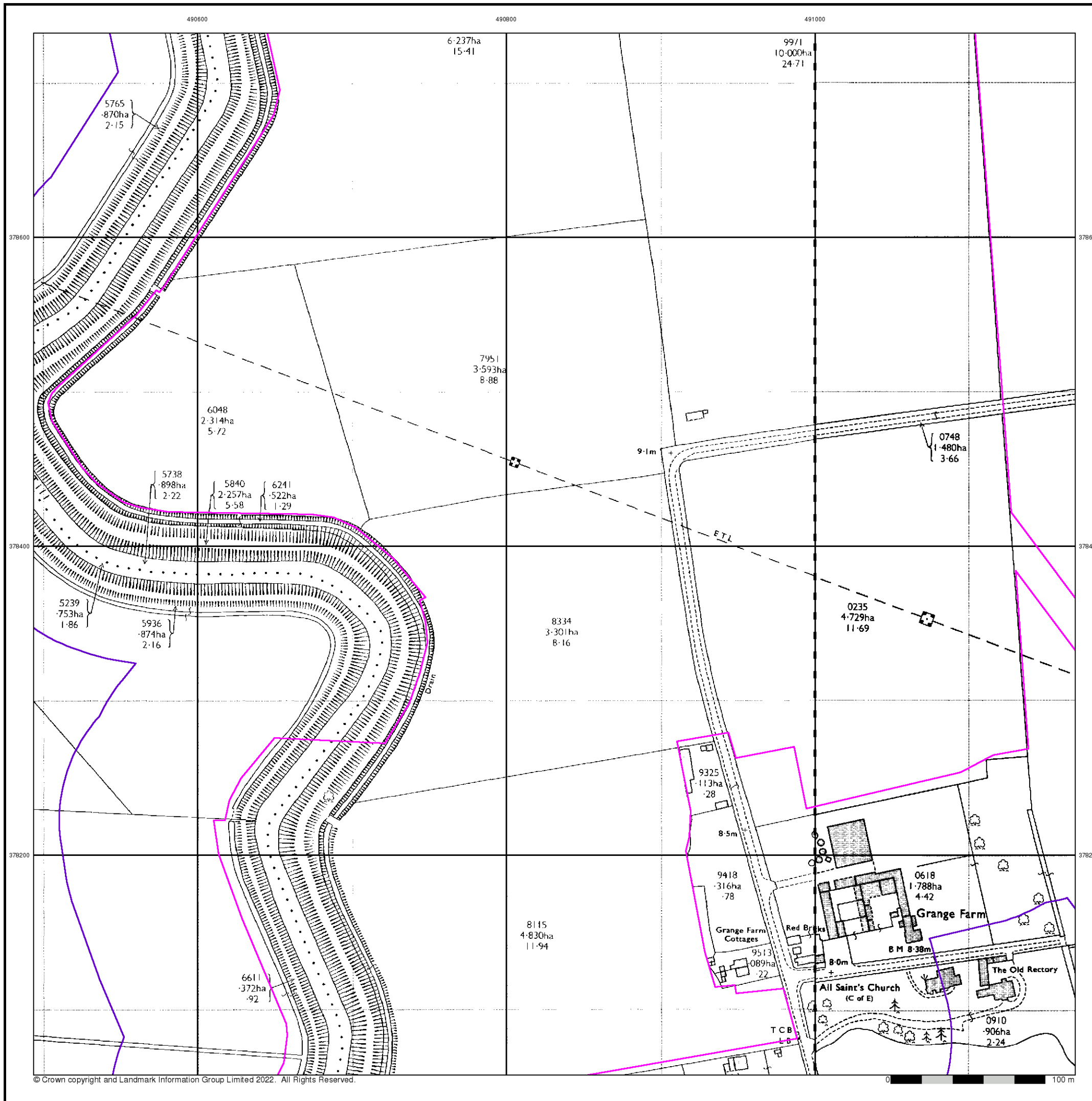

Large-Scale National Grid Data

Published 1994

Source map scale - 1:2,500

'Large Scale National Grid Data' superseded SIM cards (Ordnance Survey's 'Survey of Information on Microfilm') in 1992, and continued to be produced until 1999. These maps were the fore-runners of digital mapping and so provide detailed information on houses and roads, but tend to show less topographic features such as vegetation. These maps were produced at both 1:2,500 and 1:1,250 scales.

Map Name(s) and Date(s)

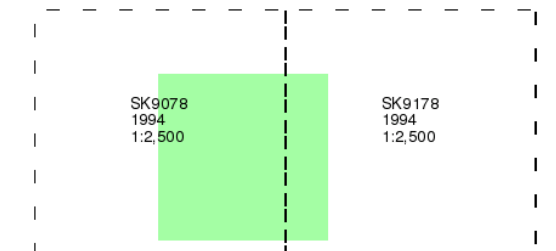

Historical Map - Segment D9

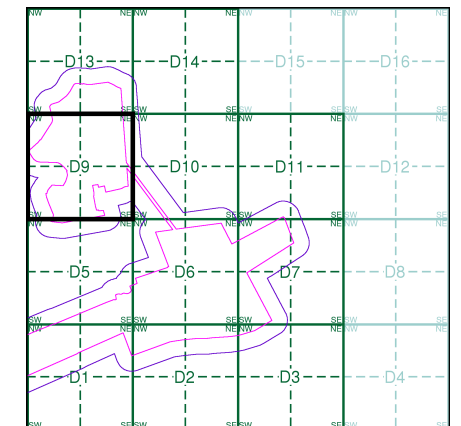

Order Details

Order Number: 298001007_1_1
 Customer Ref: 21-1098.04
 National Grid Reference: 491280, 377900
 Slice: D
 Site Area (Ha): 471.82
 Search Buffer (m): 100

Site Details

West Barton 1



Historical Mapping Legends

Ordnance Survey County Series and Ordnance Survey Plan 1:2,500

Quarry **Gravel Pit** **Sand Pit**
Clay Pit **Shingle** **Refuse Heap**
Sloping Masonry **Flat Rock**
Marsh **Reeds** **Osiers**
Rough Pasture **Furze** **Wood**
Mixed Wood **Brushwood** **Orchard**
Fir **Ford** **Stepping Stones**
Ferry **Waterfall** **Lock**
Trig. Station **Altitude at Trig. Station**
B.M. 325.9 **Bench Mark** **Surface Level**
Arrow denotes flow of water **Antiquities (site of)**
Cutting **Embankment**
Railway crossing Road **Level Crossing** **Road crossing Railway**
Railway crossing River or Canal **Road over single stream** **Road over River or Canal**
County Boundary (Geographical)
County & Civil Parish Boundary
Administrative County & Civil Parish Boundary
County Borough Boundary (England)
County Burgh Boundary (Scotland)
Boundary Post or Stone **Police Call Box**
B.R. Bridle Road **Pump**
E.P. Electricity Pylon **S.P. Signal Post**
F.B. Foot Bridge **Sl. Sluice**
F.P. Foot Path **Sp. Spring**
G.P. Guide Post or Board **T.C.B. Telephone Call Box**
M.S. Mile Stone **Tr. Trough**
M.P. M.R. Mooring Post or Ring **W. Well**

Ordnance Survey Plan, Additional SIMs and Supply of Unpublished Survey Information 1:2,500 and 1:1,250

Inactive Quarry, Chalk Pit or Clay Pit **Active Quarry, Chalk Pit or Clay Pit**
Rock **Boulders**
Cliff **Slopes** **Top**
Roofed Building **Glazed Roof Building**
Sloping Masonry **Archway**
Non-Coniferous Tree (surveyed) **Coniferous Tree (surveyed)**
Non-Coniferous Trees (not surveyed) **Coniferous Trees (not surveyed)**
Orchard Tree **Scrub** **Bracken**
Coppice, Osier **Reeds** **Marsh, Saltings**
Rough Grassland **Heath** **Culvert**
Direction of water flow **Bench Mark** **Antiquity (site of)**
Cave Entrance **Triangulation Station** **Electricity Pylon**
Electricity Transmission Line
County Boundary (Geographical)
County & Civil Parish Boundary
Civil Parish Boundary
Admin. County or County Bor. Boundary
London Borough Boundary
Symbol marking point where boundary mereing changes
Beer House **Pillar, Pole or Post**
Boundary Post or Stone **Post Office**
Capstan, Crane **Public Convenience**
Chimney **Public House**
Drinking Fountain **Pump**
Electricity Pillar or Post **Signal Box or Bridge**
Fire Alarm Pillar **Signal Post or Light**
Foot Bridge **Spring**
Guide Post **Tank or Track**
Hydrant or Hydraulic **Telephone Call Box**
Level Crossing **Telephone Call Post**
Manhole **Trough**
Mile Post or Mooring Post **Water Point, Water Tap**
Mile Stone **Well**
Normal Tidal Limit **Wind Pump**

Large-Scale National Grid Data 1:2,500 and 1:1,250

Cliff **Slopes** **Top**
Rock **Rock (scattered)**
Boulders **Boulders (scattered)**
Positioned Boulder **Scree**
Non-Coniferous Tree (surveyed) **Coniferous Tree (surveyed)**
Non-Coniferous Trees (not surveyed) **Coniferous Trees (not surveyed)**
Orchard Tree **Scrub** **Bracken**
Coppice, Osier **Reeds** **Marsh, Saltings**
Rough Grassland **Heath** **Culvert**
Direction of water flow **Triangulation Station** **Antiquity (site of)**
Electricity Transmission Line **Electricity Pylon**
Bench Mark **Buildings with Building Seed**
Roofed Building **Glazed Roof Building**
Civil parish/community boundary
District boundary
County boundary
Boundary post/stone
Boundary mereing symbol (note: these always appear in opposed pairs or groups of three)
Barracks **Pillar, Pole or Post**
Battery **Post Office**
Cemetery **Public Convenience**
Chimney **Pump**
Cistern **Pumping Station**
Dismtd Rly **Place of Worship**
Electricity Generating Station **Sewage Ppg Sta** **Sewage Pumping Station**
Electricity Pole, Pillar **Signal Box or Bridge**
Electricity Sub Station **Signal Post or Light**
Filter Bed **Spring**
Fountain / Drinking Ftn. **Tank or Track**
Gas Valve Compound **Trough**
Gas Governor **Wind Pump**
Guide Post **Water Point, Water Tap**
Manhole **Works (building or area)**
Mile Post or Mile Stone **Well**

Historical Mapping & Photography included:

Mapping Type	Scale	Date	Pg
Lincolnshire	1:2,500	1886	2
Lincolnshire	1:2,500	1906	3
Ordnance Survey Plan	1:2,500	1974	4
Large-Scale National Grid Data	1:2,500	1994	5

Historical Map - Segment D10

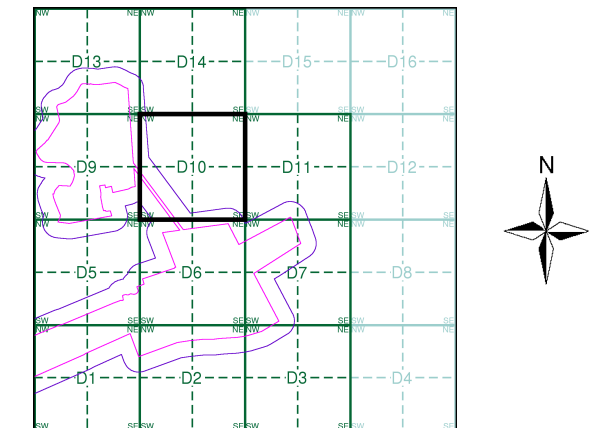

Order Details

Order Number: 298001007_1_1
 Customer Ref: 21-1098.04
 National Grid Reference: 491280, 377900
 Slice: D
 Site Area (Ha): 471.82
 Search Buffer (m): 100

Site Details

West Barton 1

Lincolnshire

Published 1886

Source map scale - 1:2,500

The historical maps shown were reproduced from maps predominantly held at the scale adopted for England, Wales and Scotland in the 1840's. In 1854 the 1:2,500 scale was adopted for mapping urban areas and by 1896 it covered the whole of what were considered to be the cultivated parts of Great Britain. The published date given below is often some years later than the surveyed date. Before 1938, all OS maps were based on the Cassini Projection, with independent surveys of a single county or group of counties, giving rise to significant inaccuracies in outlying areas.

Map Name(s) and Date(s)

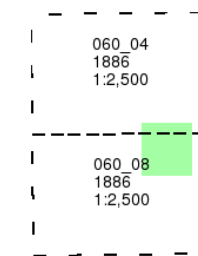

Historical Map - Segment D10

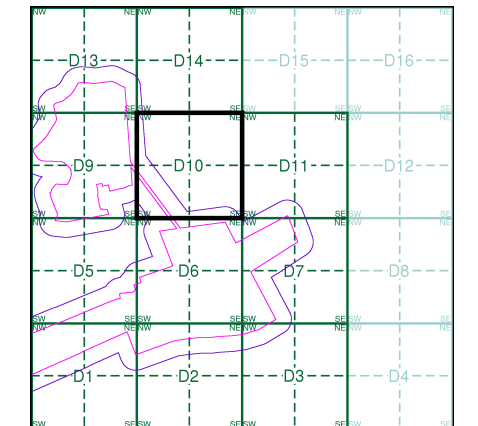

Order Details

Order Number: 298001007_1_1
 Customer Ref: 21-1098.04
 National Grid Reference: 491280, 377900
 Slice: D
 Site Area (Ha): 471.82
 Search Buffer (m): 100

Site Details

West Barton 1

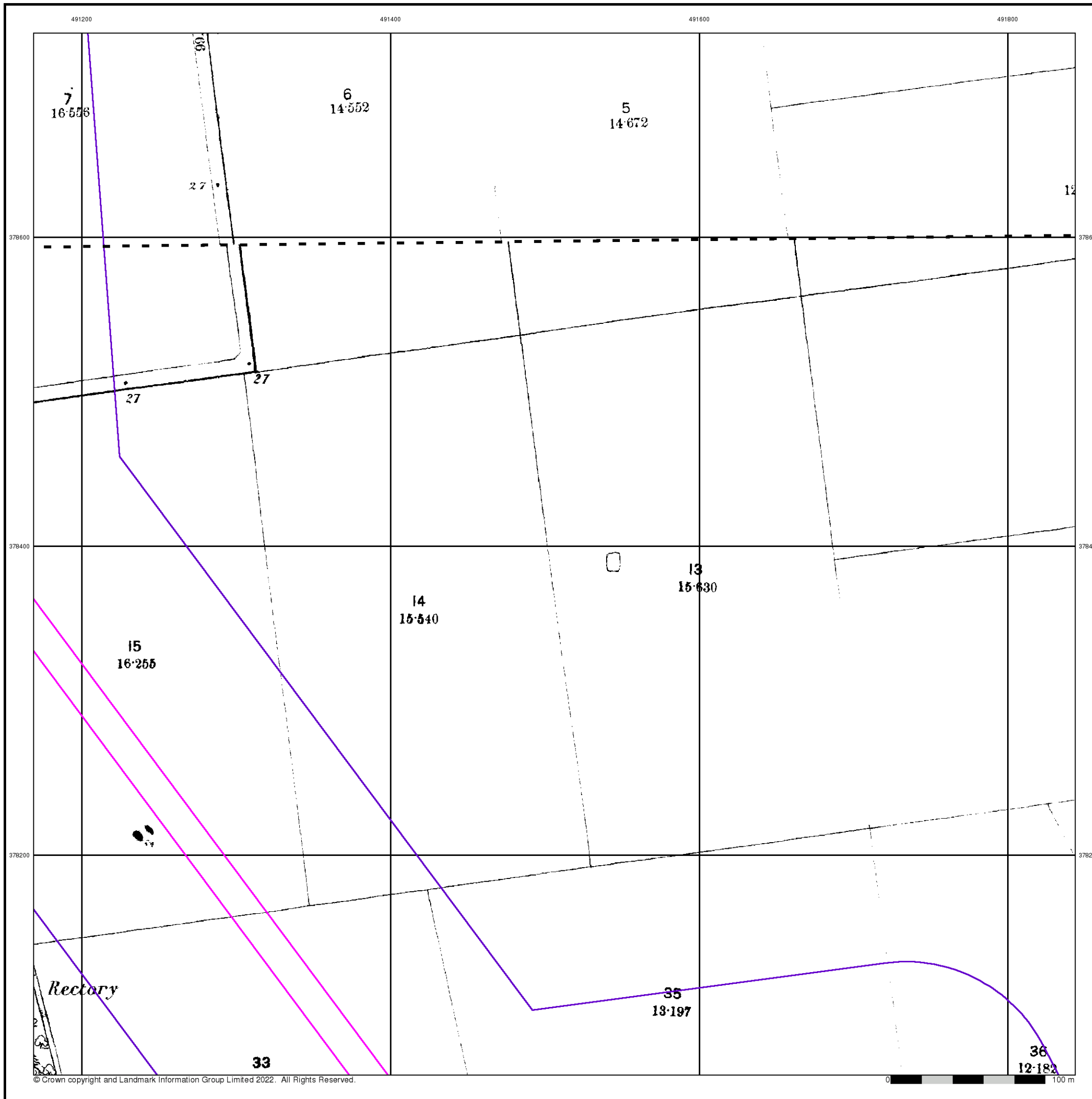

Lincolnshire

Published 1906

Source map scale - 1:2,500

The historical maps shown were reproduced from maps predominantly held at the scale adopted for England, Wales and Scotland in the 1840's. In 1854 the 1:2,500 scale was adopted for mapping urban areas and by 1896 it covered the whole of what were considered to be the cultivated parts of Great Britain. The published date given below is often some years later than the surveyed date. Before 1938, all OS maps were based on the Cassini Projection, with independent surveys of a single county or group of counties, giving rise to significant inaccuracies in outlying areas.

Map Name(s) and Date(s)

060_04	1906	1:2,500
060_08	1906	1:2,500

Historical Map - Segment D10

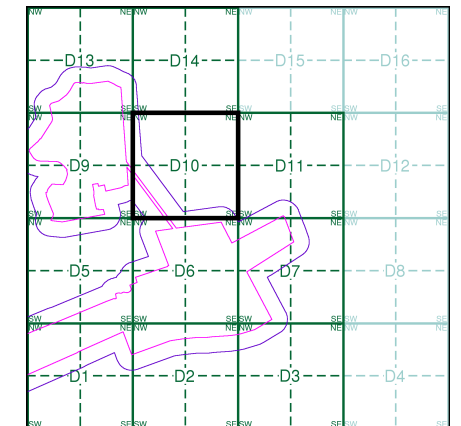

Order Details

Order Number: 298001007_1_1
 Customer Ref: 21-1098.04
 National Grid Reference: 491280, 377900
 Slice: D
 Site Area (Ha): 471.82
 Search Buffer (m): 100

Site Details

West Barton 1

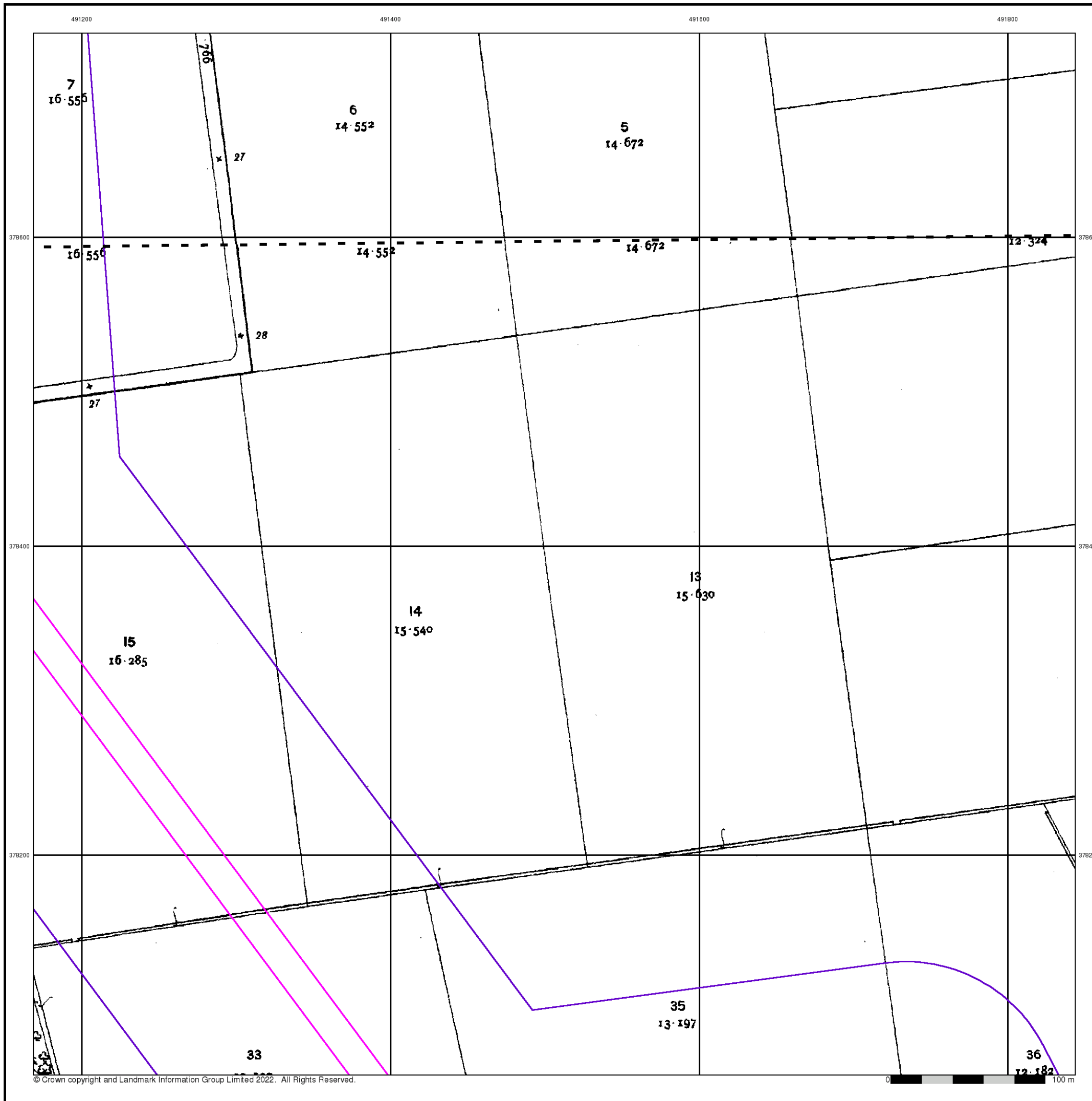

Ordnance Survey Plan

Published 1974

Source map scale - 1:2,500

The historical maps shown were reproduced from maps predominantly held at the scale adopted for England, Wales and Scotland in the 1840's. In 1854 the 1:2,500 scale was adopted for mapping urban areas and by 1896 it covered the whole of what were considered to be the cultivated parts of Great Britain. The published date given below is often some years later than the surveyed date. Before 1938, all OS maps were based on the Cassini Projection, with independent surveys of a single county or group of counties, giving rise to significant inaccuracies in outlying areas.

Map Name(s) and Date(s)

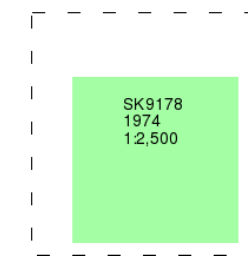

Historical Map - Segment D10

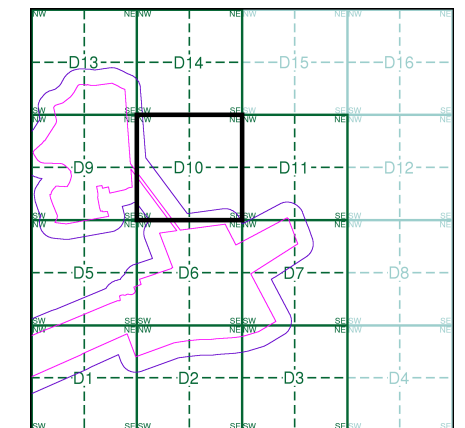

Order Details

Order Number: 298001007_1_1
 Customer Ref: 21-1098.04
 National Grid Reference: 491280, 377900
 Slice: D
 Site Area (Ha): 471.82
 Search Buffer (m): 100

Site Details

West Barton 1

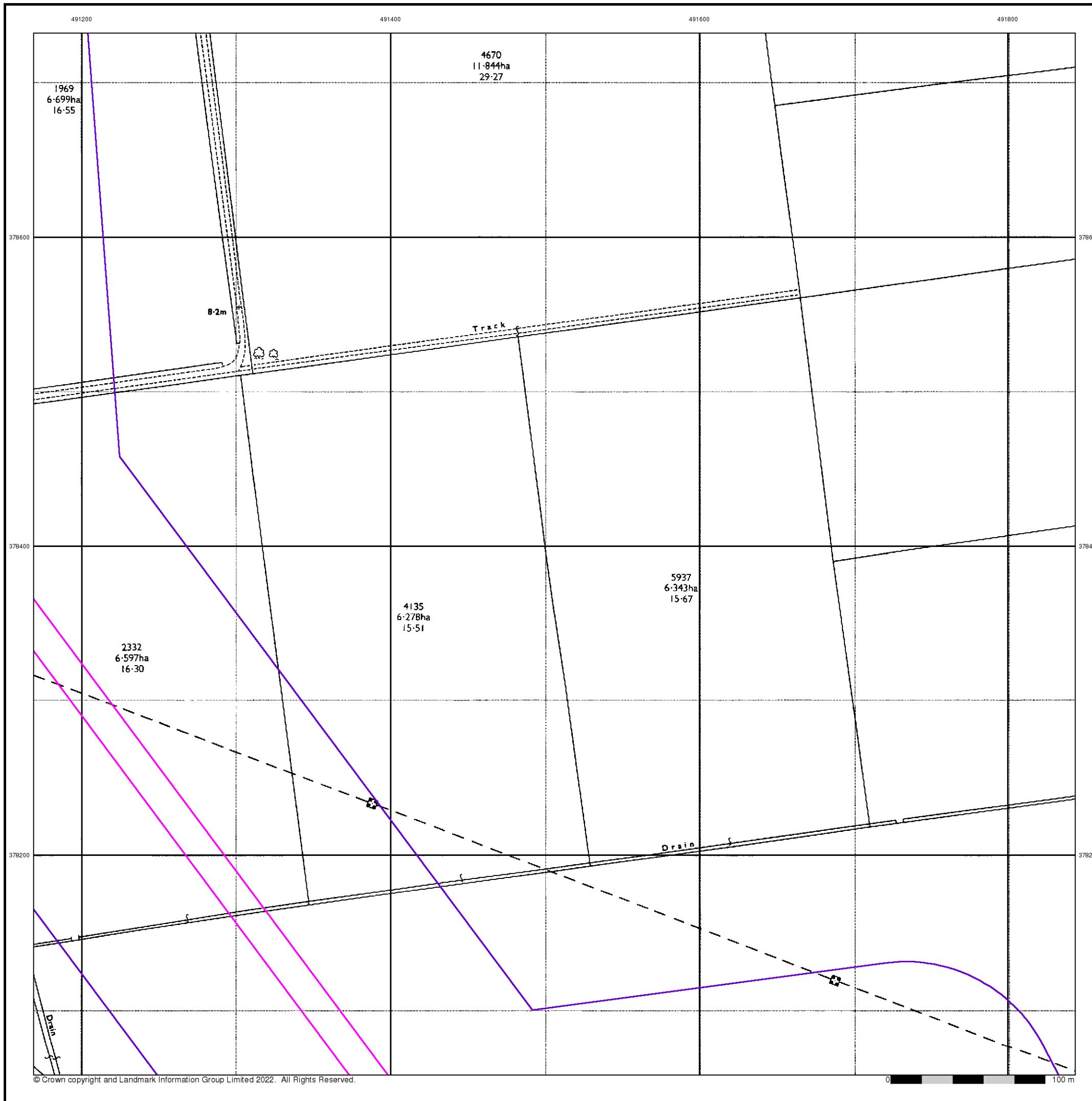

Large-Scale National Grid Data

Published 1994

Source map scale - 1:2,500

'Large Scale National Grid Data' superseded SIM cards (Ordnance Survey's 'Survey of Information on Microfilm') in 1992, and continued to be produced until 1999. These maps were the fore-runners of digital mapping and so provide detailed information on houses and roads, but tend to show less topographic features such as vegetation. These maps were produced at both 1:2,500 and 1:1,250 scales.

Map Name(s) and Date(s)

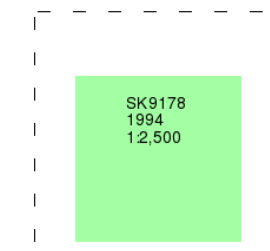

Historical Map - Segment D10

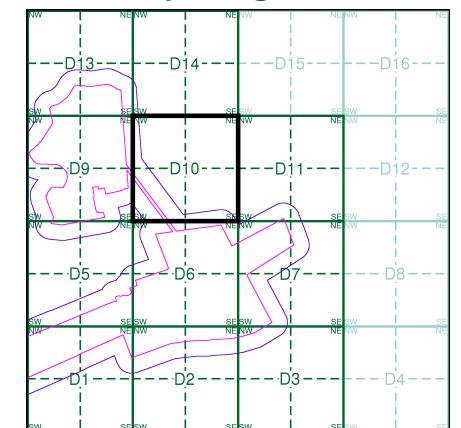

Order Details

Order Number: 298001007_1_1
 Customer Ref: 21-1098.04
 National Grid Reference: 491280, 377900
 Slice: D
 Site Area (Ha): 471.82
 Search Buffer (m): 100

Site Details

West Barton 1

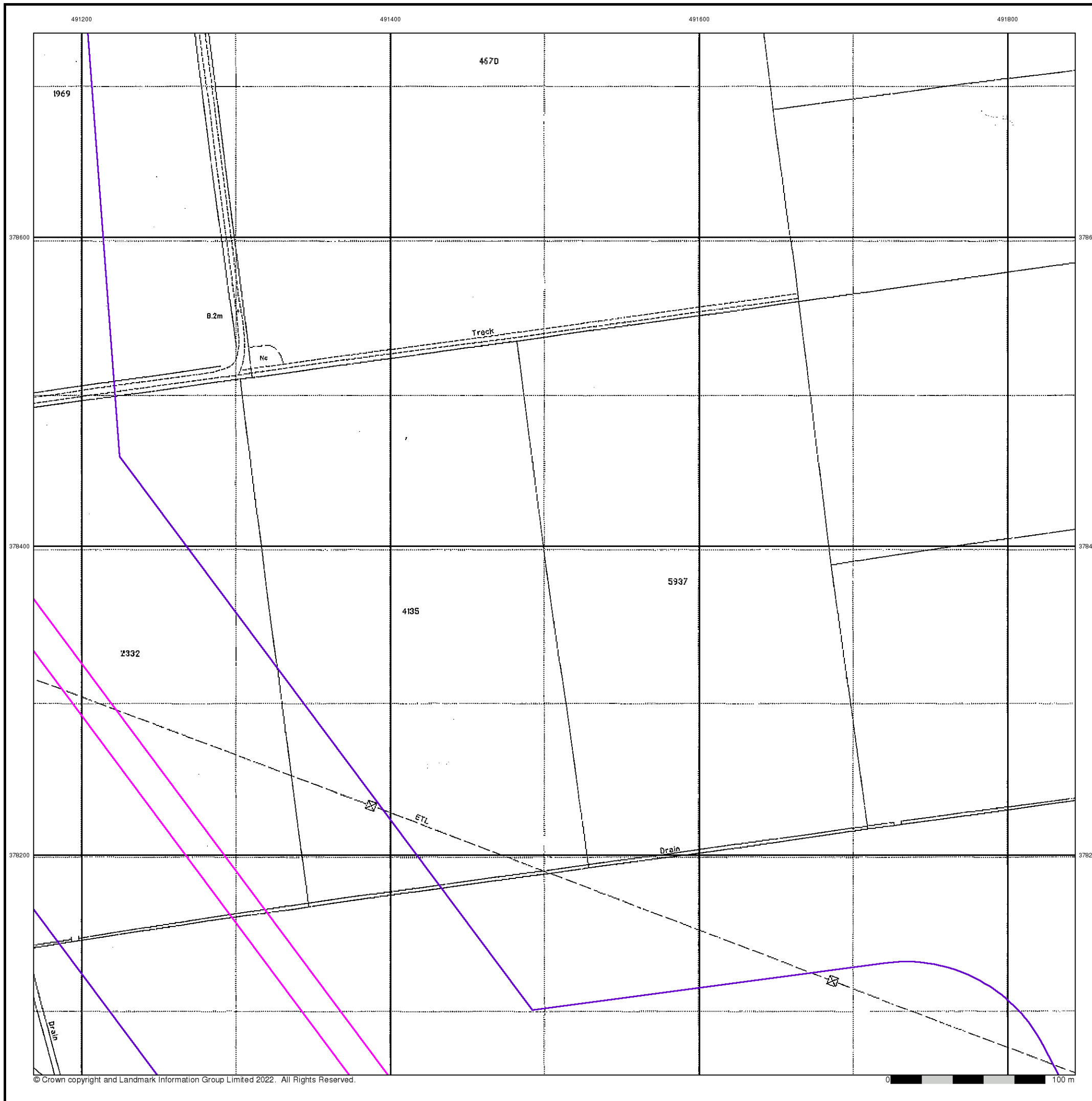

Historical Mapping Legends

Ordnance Survey County Series and Ordnance Survey Plan 1:2,500

Quarry **Gravel Pit** **Sand Pit**
Clay Pit **Shingle** **Refuse Heap**
Sloping Masonry **Flat Rock**
Marsh **Reeds** **Osiers**
Rough Pasture **Furze** **Wood**
Mixed Wood **Brushwood** **Orchard**
Fir **Ford** **Stepping Stones**
Ferry **Waterfall** **Lock**
Trig. Station **Altitude at Trig. Station**
B.M. 325.9 **Bench Mark** **Surface Level**
Arrow denotes flow of water **Antiquities (site of)**
Cutting **Embankment**
Railway crossing Road **Level Crossing** **Road crossing Railway**
Railway crossing River or Canal **Road over single stream** **Road over River or Canal**
County Boundary (Geographical)
County & Civil Parish Boundary
Administrative County & Civil Parish Boundary
County Borough Boundary (England)
County Burgh Boundary (Scotland)
Boundary Post or Stone **Police Call Box**
B.R. Bridle Road **Pump**
E.P. Electricity Pylon **S.P. Signal Post**
F.B. Foot Bridge **Sl. Sluice**
F.P. Foot Path **Sp. Spring**
G.P. Guide Post or Board **T.C.B. Telephone Call Box**
M.S. Mile Stone **Tr. Trough**
M.P. M.R. Mooring Post or Ring **W. Well**

Ordnance Survey Plan, Additional SIMs and Supply of Unpublished Survey Information 1:2,500 and 1:1,250

Inactive Quarry, Chalk Pit or Clay Pit **Active Quarry, Chalk Pit or Clay Pit**
Rock **Boulders**
Cliff **Slopes** **Top**
Roofed Building **Glazed Roof Building**
Sloping Masonry **Archway**
Non-Coniferous Tree (surveyed) **Coniferous Tree (surveyed)**
Non-Coniferous Trees (not surveyed) **Coniferous Trees (not surveyed)**
Orchard Tree **Scrub** **Bracken**
Coppice, Osier **Reeds** **Marsh, Saltings**
Rough Grassland **Heath** **Culvert**
Direction of water flow **Bench Mark** **Antiquity (site of)**
Cave Entrance **Triangulation Station** **Electricity Pylon**
Electricity Transmission Line
County Boundary (Geographical)
County & Civil Parish Boundary
Civil Parish Boundary
Admin. County or County Bor. Boundary
London Borough Boundary
Symbol marking point where boundary mereing changes
BH Beer House **P Pillar, Pole or Post**
BP, BS Boundary Post or Stone **PO Post Office**
Cn, C Capstan, Crane **PC Public Convenience**
Chy Chimney **PH Public House**
D Fn Drinking Fountain **Pp Pump**
EI P Electricity Pillar or Post **SB, S Br Signal Box or Bridge**
FAP Fire Alarm Pillar **SP, SL Signal Post or Light**
FB Foot Bridge **Spr Spring**
GP Guide Post **Tk Tank or Track**
H Hydrant or Hydraulic **TCB Telephone Call Box**
LC Level Crossing **TCP Telephone Call Post**
MH Manhole **Tr Trough**
MP Mile Post or Mooring Post **Wr Pt, Wr T Water Point, Water Tap**
MS Mile Stone **W Well**
NTL Normal Tidal Limit **Wd Pp Wind Pump**

Large-Scale National Grid Data 1:2,500 and 1:1,250

Cliff **Slopes** **Top**
Rock **Rock (scattered)**
Boulders **Boulders (scattered)**
Positioned Boulder **Scree**
Non-Coniferous Tree (surveyed) **Coniferous Tree (surveyed)**
Non-Coniferous Trees (not surveyed) **Coniferous Trees (not surveyed)**
Orchard Tree **Scrub** **Bracken**
Coppice, Osier **Reeds** **Marsh, Saltings**
Rough Grassland **Heath** **Culvert**
Direction of water flow **Triangulation Station** **Antiquity (site of)**
Electricity Transmission Line **Electricity Pylon**
Bench Mark **Buildings with Building Seed**
Roofed Building **Glazed Roof Building**
Civil parish/community boundary
District boundary
County boundary
Boundary post/stone
Boundary mereing symbol (note: these always appear in opposed pairs or groups of three)
Bks Barracks **P Pillar, Pole or Post**
Bty Battery **PO Post Office**
Cemy Cemetery **PC Public Convenience**
Chy Chimney **Pp Pump**
Cis Cistern **Ppg Sta Pumping Station**
Dismtd Rly Dismantled Railway **PW Place of Worship**
EI Gen Sta Electricity Generating Station **Sewage Ppg Sta Sewage Pumping Station**
EI P Electricity Pole, Pillar **SB, S Br Signal Box or Bridge**
EI Sub Sta Electricity Sub Station **SP, SL Signal Post or Light**
FB Filter Bed **Spr Spring**
Fn / D Fn Fountain / Drinking Ftn. **Tk Tank or Track**
Gas Gov Gas Valve Compound **Tr Trough**
GVC Gas Governor **Wd Pp Wind Pump**
GP Guide Post **Wr Pt, Wr T Water Point, Water Tap**
MH Manhole **Wks Works (building or area)**
MP, MS Mile Post or Mile Stone **W Well**

Historical Mapping & Photography included:

Mapping Type	Scale	Date	Pg
Lincolnshire	1:2,500	1886	2
Lincolnshire	1:2,500	1906	3
Ordnance Survey Plan	1:2,500	1974	4
Large-Scale National Grid Data	1:2,500	1994	5

Historical Map - Segment D11

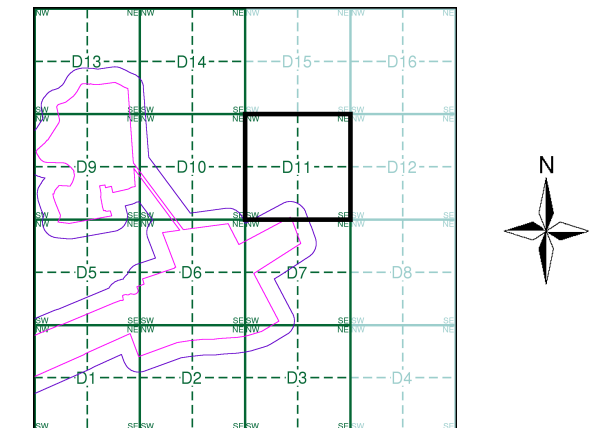

Order Details

Order Number: 298001007_1_1
 Customer Ref: 21-1098.04
 National Grid Reference: 491280, 377900
 Slice: D
 Site Area (Ha): 471.82
 Search Buffer (m): 100

Site Details

West Barton 1

Lincolnshire

Published 1886

Source map scale - 1:2,500

The historical maps shown were reproduced from maps predominantly held at the scale adopted for England, Wales and Scotland in the 1840's. In 1854 the 1:2,500 scale was adopted for mapping urban areas and by 1896 it covered the whole of what were considered to be the cultivated parts of Great Britain. The published date given below is often some years later than the surveyed date. Before 1938, all OS maps were based on the Cassini Projection, with independent surveys of a single county or group of counties, giving rise to significant inaccuracies in outlying areas.

Map Name(s) and Date(s)

060_04 1886 1:2,500	061_01 1886 1:2,500
060_08 1886 1:2,500	061_05 1886 1:2,500

Historical Map - Segment D11

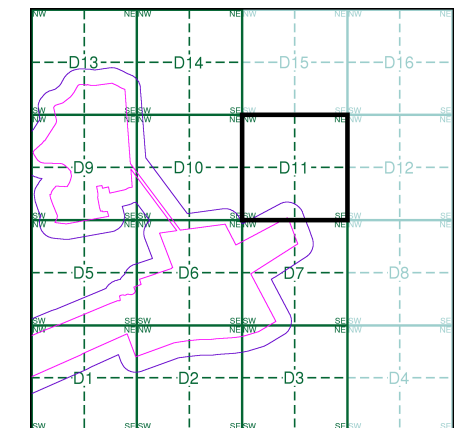

Order Details

Order Number: 298001007_1_1
 Customer Ref: 21-1098.04
 National Grid Reference: 491280, 377900
 Slice: D
 Site Area (Ha): 471.82
 Search Buffer (m): 100

Site Details

West Barton 1

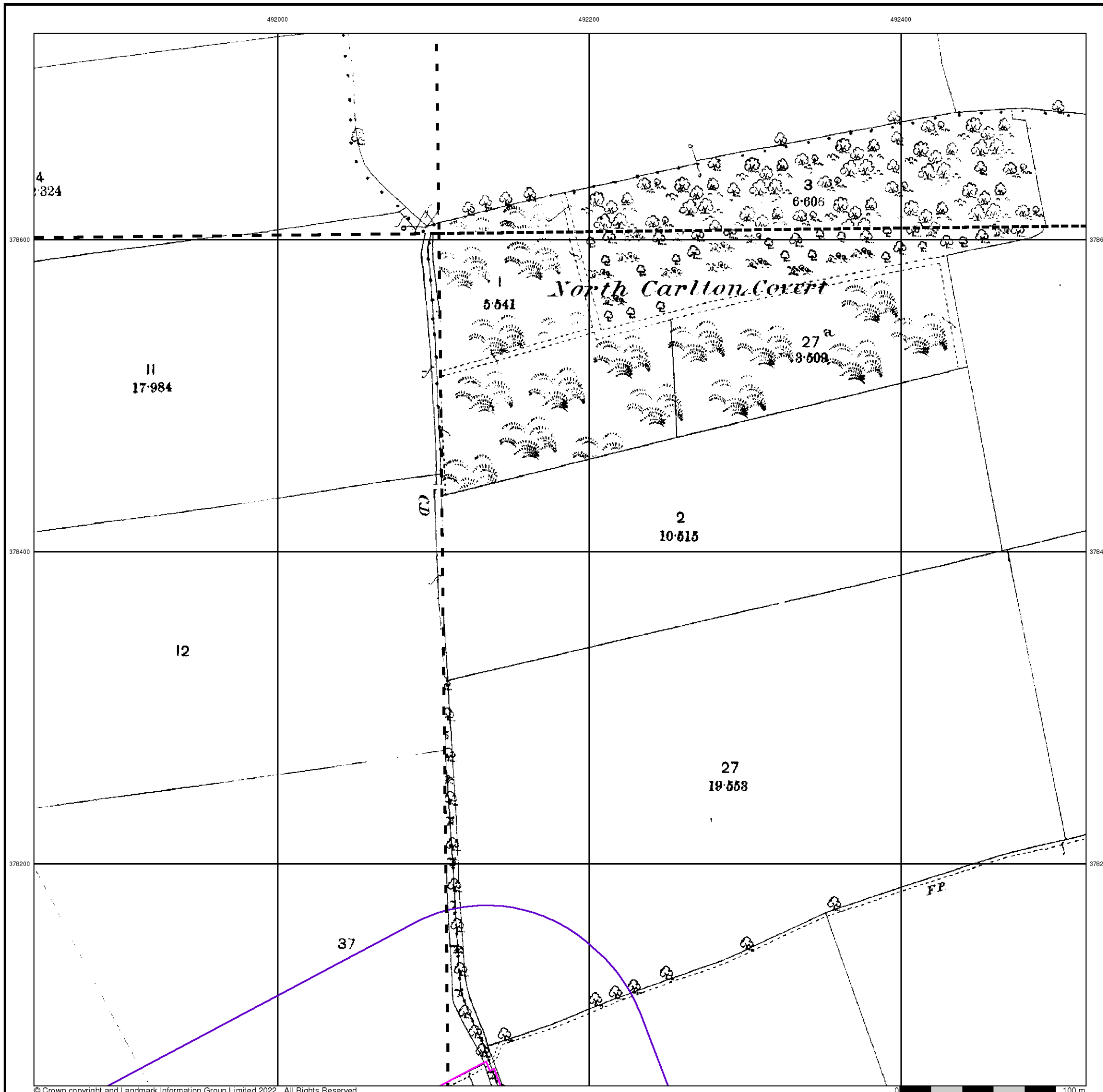

Lincolnshire

Published 1906

Source map scale - 1:2,500

The historical maps shown were reproduced from maps predominantly held at the scale adopted for England, Wales and Scotland in the 1840's. In 1854 the 1:2,500 scale was adopted for mapping urban areas and by 1896 it covered the whole of what were considered to be the cultivated parts of Great Britain. The published date given below is often some years later than the surveyed date. Before 1938, all OS maps were based on the Cassini Projection, with independent surveys of a single county or group of counties, giving rise to significant inaccuracies in outlying areas.

Map Name(s) and Date(s)

060_04 1906 1:2,500	061_01 1906 1:2,500
060_08 1906 1:2,500	061_05 1906 1:2,500

Historical Map - Segment D11

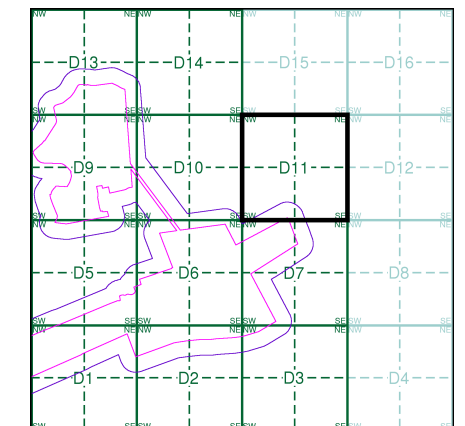

Order Details

Order Number: 298001007_1_1
 Customer Ref: 21-1098.04
 National Grid Reference: 491280, 377900
 Slice: D
 Site Area (Ha): 471.82
 Search Buffer (m): 100

Site Details

West Barton 1

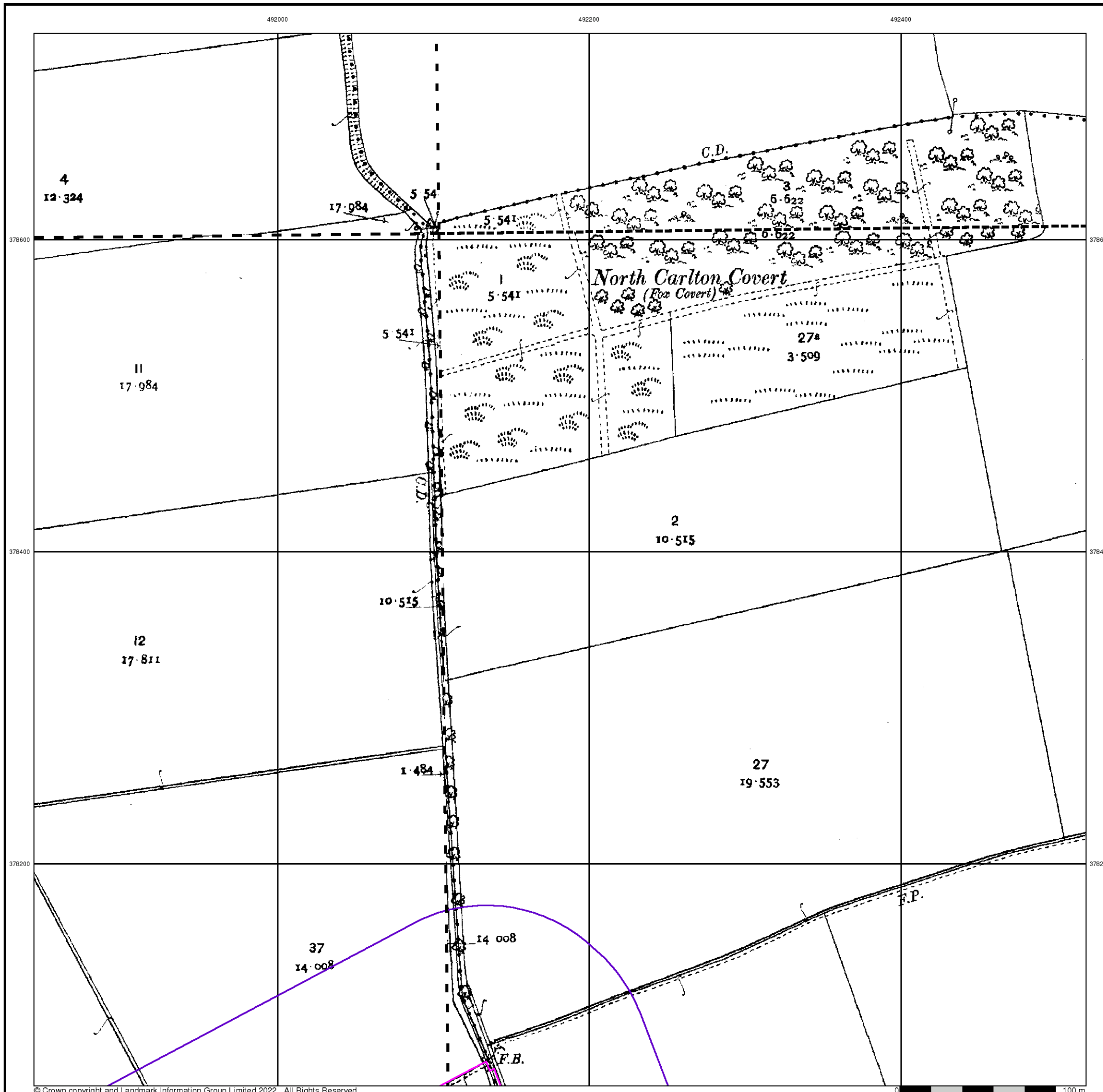

Ordnance Survey Plan

Published 1974

Source map scale - 1:2,500

The historical maps shown were reproduced from maps predominantly held at the scale adopted for England, Wales and Scotland in the 1840's. In 1854 the 1:2,500 scale was adopted for mapping urban areas and by 1896 it covered the whole of what were considered to be the cultivated parts of Great Britain. The published date given below is often some years later than the surveyed date. Before 1938, all OS maps were based on the Cassini Projection, with independent surveys of a single county or group of counties, giving rise to significant inaccuracies in outlying areas.

Map Name(s) and Date(s)

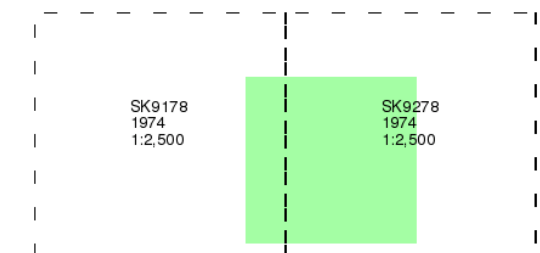

Historical Map - Segment D11

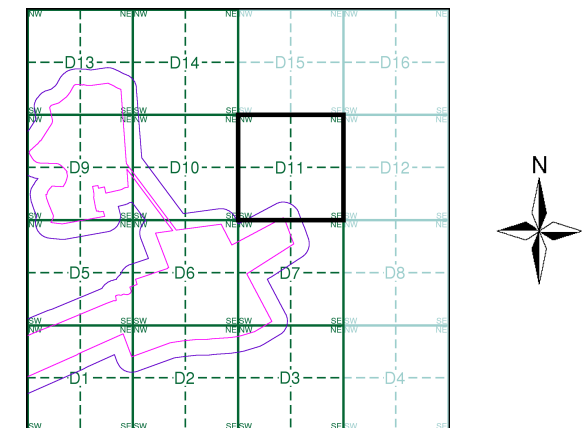

Order Details

Order Number: 298001007_1_1
 Customer Ref: 21-1098.04
 National Grid Reference: 491280, 377900
 Slice: D
 Site Area (Ha): 471.82
 Search Buffer (m): 100

Site Details

West Barton 1



Large-Scale National Grid Data

Published 1994

Source map scale - 1:2,500

'Large Scale National Grid Data' superseded SIM cards (Ordnance Survey's 'Survey of Information on Microfilm') in 1992, and continued to be produced until 1999. These maps were the fore-runners of digital mapping and so provide detailed information on houses and roads, but tend to show less topographic features such as vegetation. These maps were produced at both 1:2,500 and 1:1,250 scales.

Map Name(s) and Date(s)

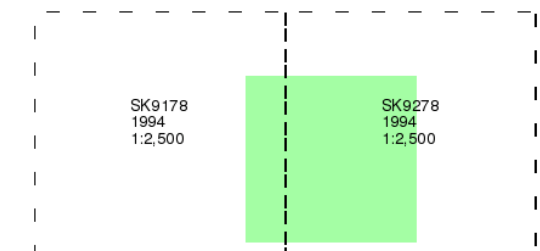

Historical Map - Segment D11

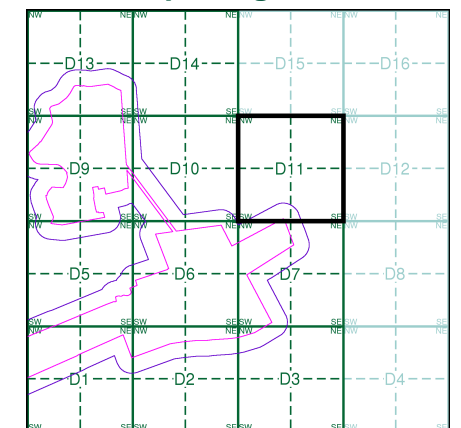

Order Details

Order Number: 298001007_1_1
 Customer Ref: 21-1098.04
 National Grid Reference: 491280, 377900
 Slice: D
 Site Area (Ha): 471.82
 Search Buffer (m): 100

Site Details

West Barton 1

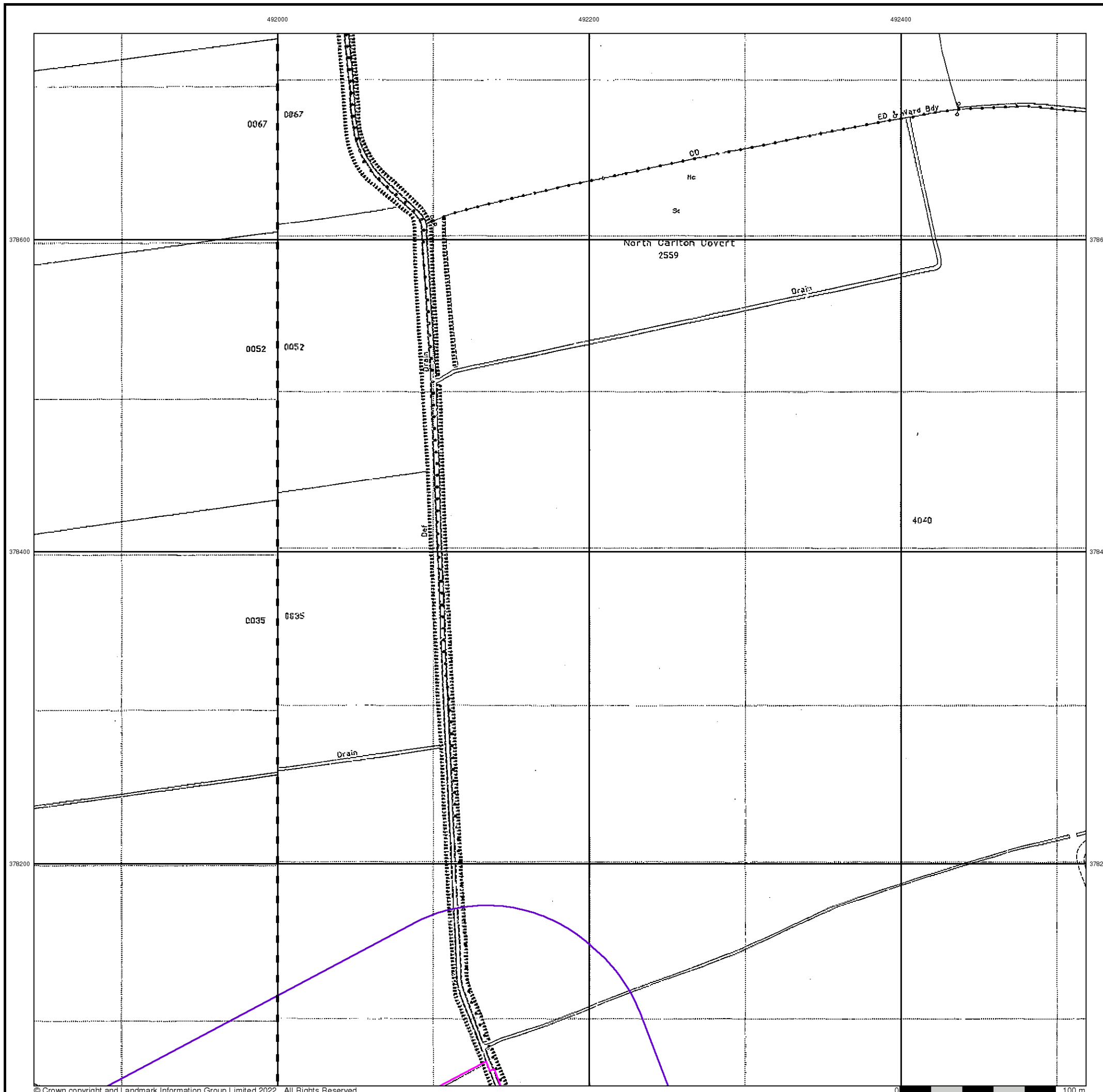

Historical Mapping Legends

Ordnance Survey County Series and Ordnance Survey Plan 1:2,500

Quarry **Gravel Pit** **Sand Pit**
Clay Pit **Shingle** **Refuse Heap**
Sloping Masonry **Flat Rock**
Marsh **Reeds** **Osiers**
Rough Pasture **Furze** **Wood**
Mixed Wood **Brushwood** **Orchard**
Fir **Ford** **Stepping Stones**
Ferry **Waterfall** **Lock**
Trig. Station **Altitude at Trig. Station**
B.M. 325.9 **Bench Mark** **Surface Level**
Arrow denotes flow of water **Antiquities (site of)**
Cutting **Embankment**
Railway crossing Road **Level Crossing** **Road crossing Railway**
Railway crossing River or Canal **Road over single stream** **Road over River or Canal**
County Boundary (Geographical)
County & Civil Parish Boundary
Administrative County & Civil Parish Boundary
County Borough Boundary (England)
County Burgh Boundary (Scotland)
Co. Boro. Bdy.
Co. Burgh Bdy.
BP BS Boundary Post or Stone **P.C.B** Police Call Box
B.R. Bridle Road **P** Pump
E.P Electricity Pylon **S.P** Signal Post
F.B. Foot Bridge **SL** Sluice
F.P. Foot Path **Sp.** Spring
G.P Guide Post or Board **T.C.B** Telephone Call Box
M.S Mile Stone **Tr.** Trough
M.P M.R Mooring Post or Ring **W** Well

Ordnance Survey Plan, Additional SIMs and Supply of Unpublished Survey Information 1:2,500 and 1:1,250

Inactive Quarry, Chalk Pit or Clay Pit **Active Quarry, Chalk Pit or Clay Pit**
Rock **Boulders**
Cliff **Slopes** **Top**
Roofed Building **Glazed Roof Building**
Sloping Masonry **Archway**
Non-Coniferous Tree (surveyed) **Coniferous Tree (surveyed)**
Non-Coniferous Trees (not surveyed) **Coniferous Trees (not surveyed)**
Orchard Tree **Scrub** **Bracken**
Coppice, Osier **Reeds** **Marsh, Saltings**
Rough Grassland **Heath** **Culvert**
Direction of water flow **Bench Mark** **Antiquity (site of)**
Cave Entrance **Triangulation Station** **Electricity Pylon**
Electricity Transmission Line
County Boundary (Geographical)
County & Civil Parish Boundary
Civil Parish Boundary
Admin. County or County Bor. Boundary
London Borough Boundary
Symbol marking point where boundary mereing changes
BH Beer House **P** Pillar, Pole or Post
BP, BS Boundary Post or Stone **PO** Post Office
Cn, C Capstan, Crane **PC** Public Convenience
Chy Chimney **PH** Public House
D Fn Drinking Fountain **Pp** Pump
EI P Electricity Pillar or Post **SB, S Br** Signal Box or Bridge
FAP Fire Alarm Pillar **SP, SL** Signal Post or Light
FB Foot Bridge **Spr** Spring
GP Guide Post **Tk** Tank or Track
H Hydrant or Hydraulic **TCB** Telephone Call Box
LC Level Crossing **TCP** Telephone Call Post
MH Manhole **Tr** Trough
MP Mile Post or Mooring Post **Wr Pt, Wr T** Water Point, Water Tap
MS Mile Stone **W** Well
NTL Normal Tidal Limit **Wd Pp** Wind Pump

Large-Scale National Grid Data 1:2,500 and 1:1,250

Cliff **Slopes** **Top**
Rock **Rock (scattered)**
Boulders **Boulders (scattered)**
Positioned Boulder **Scree**
Non-Coniferous Tree (surveyed) **Coniferous Tree (surveyed)**
Non-Coniferous Trees (not surveyed) **Coniferous Trees (not surveyed)**
Orchard Tree **Scrub** **Bracken**
Coppice, Osier **Reeds** **Marsh, Saltings**
Rough Grassland **Heath** **Culvert**
Direction of water flow **Triangulation Station** **Antiquity (site of)**
Electricity Transmission Line **Electricity Pylon**
B.M. 231.60m Bench Mark **Buildings with Building Seed**
Roofed Building **Glazed Roof Building**
Civil parish/community boundary
District boundary
County boundary
Boundary post/stone
Boundary mereing symbol (note: these always appear in opposed pairs or groups of three)
Bks Barracks **P** Pillar, Pole or Post
Bty Battery **PO** Post Office
Cemy Cemetery **PC** Public Convenience
Chy Chimney **Pp** Pump
Cis Cistern **Ppg Sta** Pumping Station
Dismtd Rly Dismantled Railway **PW** Place of Worship
EI Gen Sta Electricity Generating Station **Sewage Ppg Sta** Sewage Pumping Station
EI P Electricity Pole, Pillar **SB, S Br** Signal Box or Bridge
EI Sub Sta Electricity Sub Station **SP, SL** Signal Post or Light
FB Filter Bed **Spr** Spring
Fn / D Fn Fountain / Drinking Ftn. **Tk** Tank or Track
Gas Gov Gas Valve Compound **Tr** Trough
GVC Gas Governor **Wd Pp** Wind Pump
GP Guide Post **Wr Pt, Wr T** Water Point, Water Tap
MH Manhole **Wks** Works (building or area)
MP, MS Mile Post or Mile Stone **W** Well

Historical Mapping & Photography included:

Mapping Type	Scale	Date	Pg
Lincolnshire	1:2,500	1886	2
Lincolnshire	1:2,500	1906	3
Ordnance Survey Plan	1:2,500	1973 - 1974	4
Additional SIMs	1:2,500	1993	5
Large-Scale National Grid Data	1:2,500	1994	6

Historical Map - Segment D13

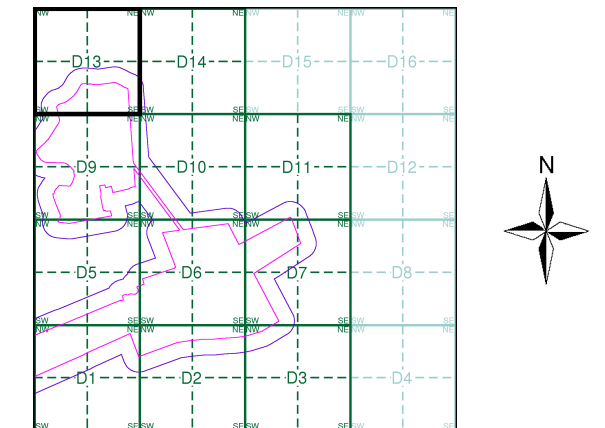

Order Details

Order Number: 298001007_1_1
 Customer Ref: 21-1098.04
 National Grid Reference: 491280, 377900
 Slice: D
 Site Area (Ha): 471.82
 Search Buffer (m): 100

Site Details

West Barton 1

Lincolnshire

Published 1886

Source map scale - 1:2,500

The historical maps shown were reproduced from maps predominantly held at the scale adopted for England, Wales and Scotland in the 1840's. In 1854 the 1:2,500 scale was adopted for mapping urban areas and by 1896 it covered the whole of what were considered to be the cultivated parts of Great Britain. The published date given below is often some years later than the surveyed date. Before 1938, all OS maps were based on the Cassini Projection, with independent surveys of a single county or group of counties, giving rise to significant inaccuracies in outlying areas.

Map Name(s) and Date(s)

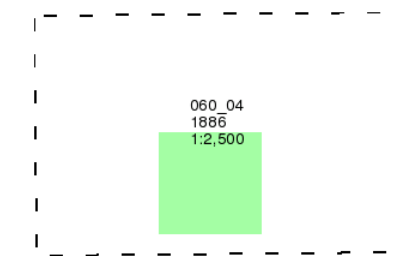

Historical Map - Segment D13

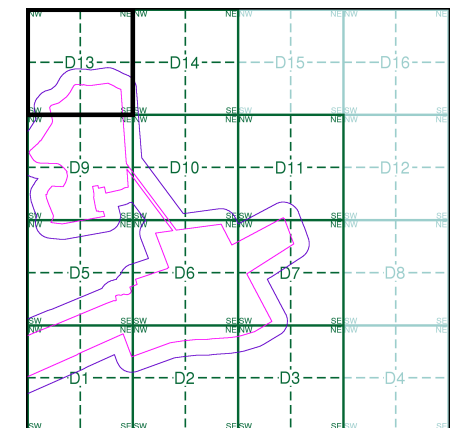

Order Details

Order Number: 298001007_1_1
 Customer Ref: 21-1098.04
 National Grid Reference: 491280, 377900
 Slice: D
 Site Area (Ha): 471.82
 Search Buffer (m): 100

Site Details

West Barton 1

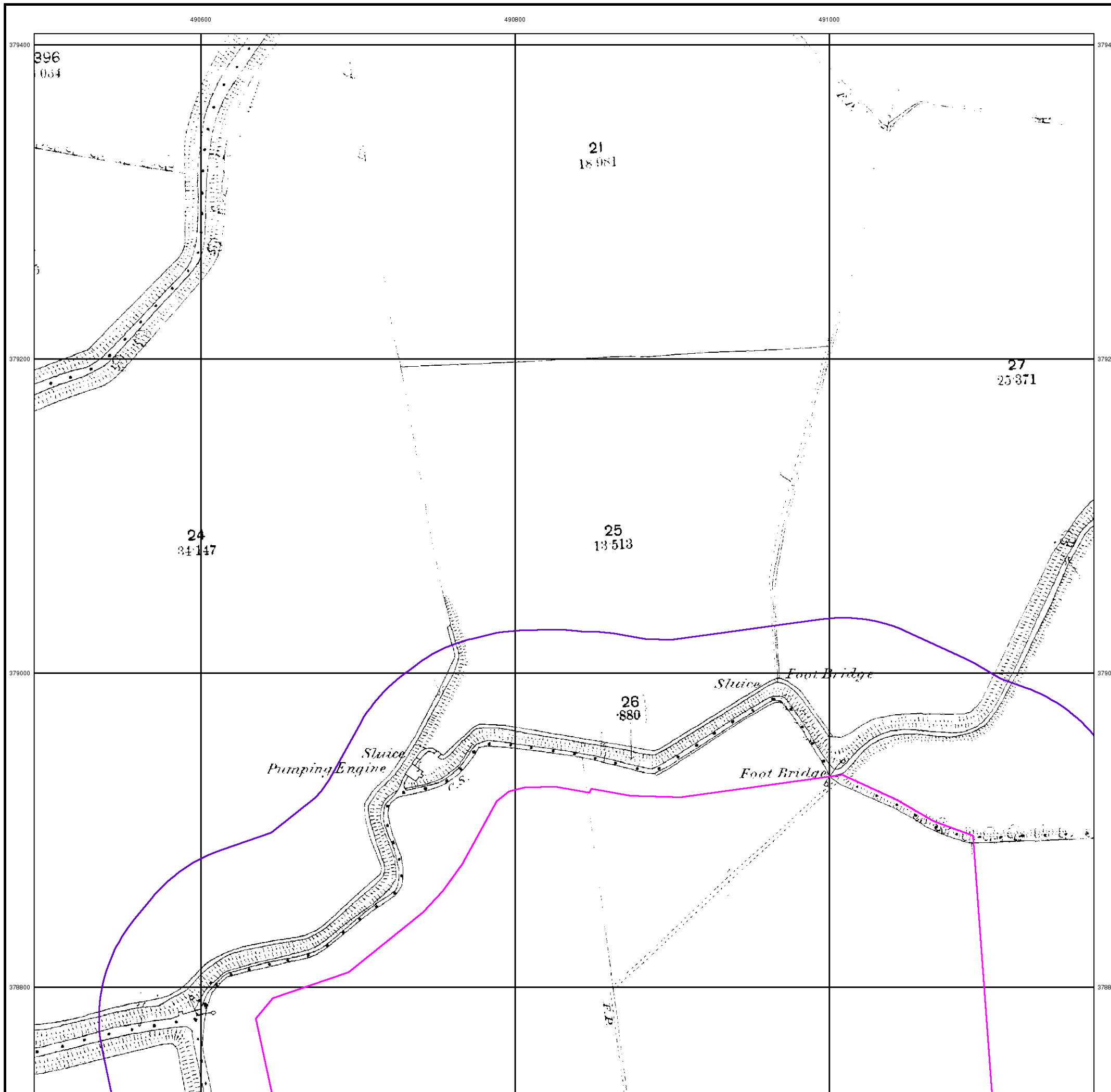

Lincolnshire

Published 1906

Source map scale - 1:2,500

The historical maps shown were reproduced from maps predominantly held at the scale adopted for England, Wales and Scotland in the 1840's. In 1854 the 1:2,500 scale was adopted for mapping urban areas and by 1896 it covered the whole of what were considered to be the cultivated parts of Great Britain. The published date given below is often some years later than the surveyed date. Before 1938, all OS maps were based on the Cassini Projection, with independent surveys of a single county or group of counties, giving rise to significant inaccuracies in outlying areas.

Map Name(s) and Date(s)

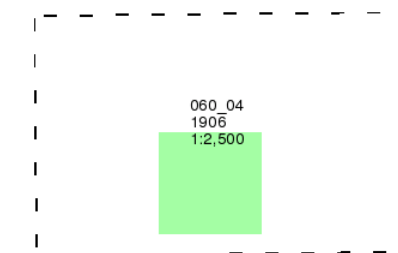

Historical Map - Segment D13

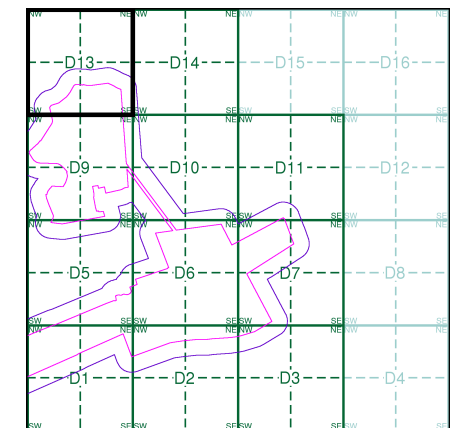

Order Details

Order Number: 298001007_1_1
 Customer Ref: 21-1098.04
 National Grid Reference: 491280, 377900
 Slice: D
 Site Area (Ha): 471.82
 Search Buffer (m): 100

Site Details

West Barton 1

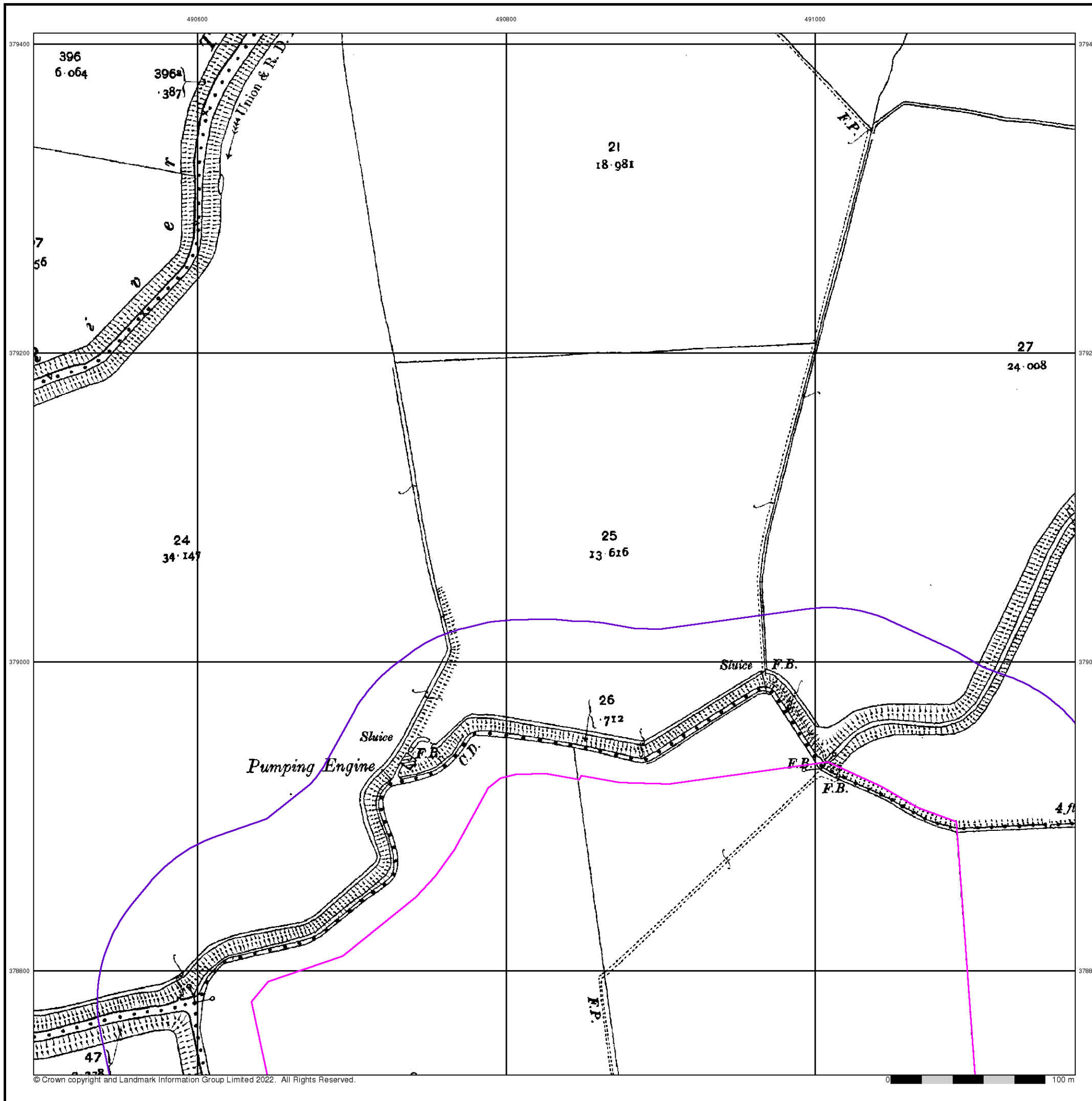

Ordnance Survey Plan
Published 1973 - 1974
Source map scale - 1:2,500

The historical maps shown were reproduced from maps predominantly held at the scale adopted for England, Wales and Scotland in the 1840's. In 1854 the 1:2,500 scale was adopted for mapping urban areas and by 1896 it covered the whole of what were considered to be the cultivated parts of Great Britain. The published date given below is often some years later than the surveyed date. Before 1938, all OS maps were based on the Cassini Projection, with independent surveys of a single county or group of counties, giving rise to significant inaccuracies in outlying areas.

Map Name(s) and Date(s)

SK9079 1973 1:2,500	SK9179 1973 1:2,500
SK9078 1974 1:2,500	SK9178 1974 1:2,500

Historical Map - Segment D13

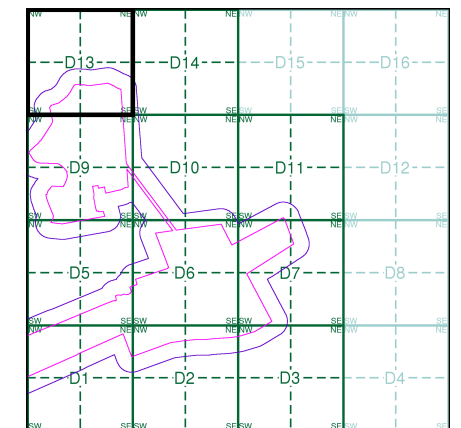

Order Details

Order Number: 298001007_1_1
 Customer Ref: 21-1098.04
 National Grid Reference: 491280, 377900
 Slice: D
 Site Area (Ha): 471.82
 Search Buffer (m): 100

Site Details

West Barton 1

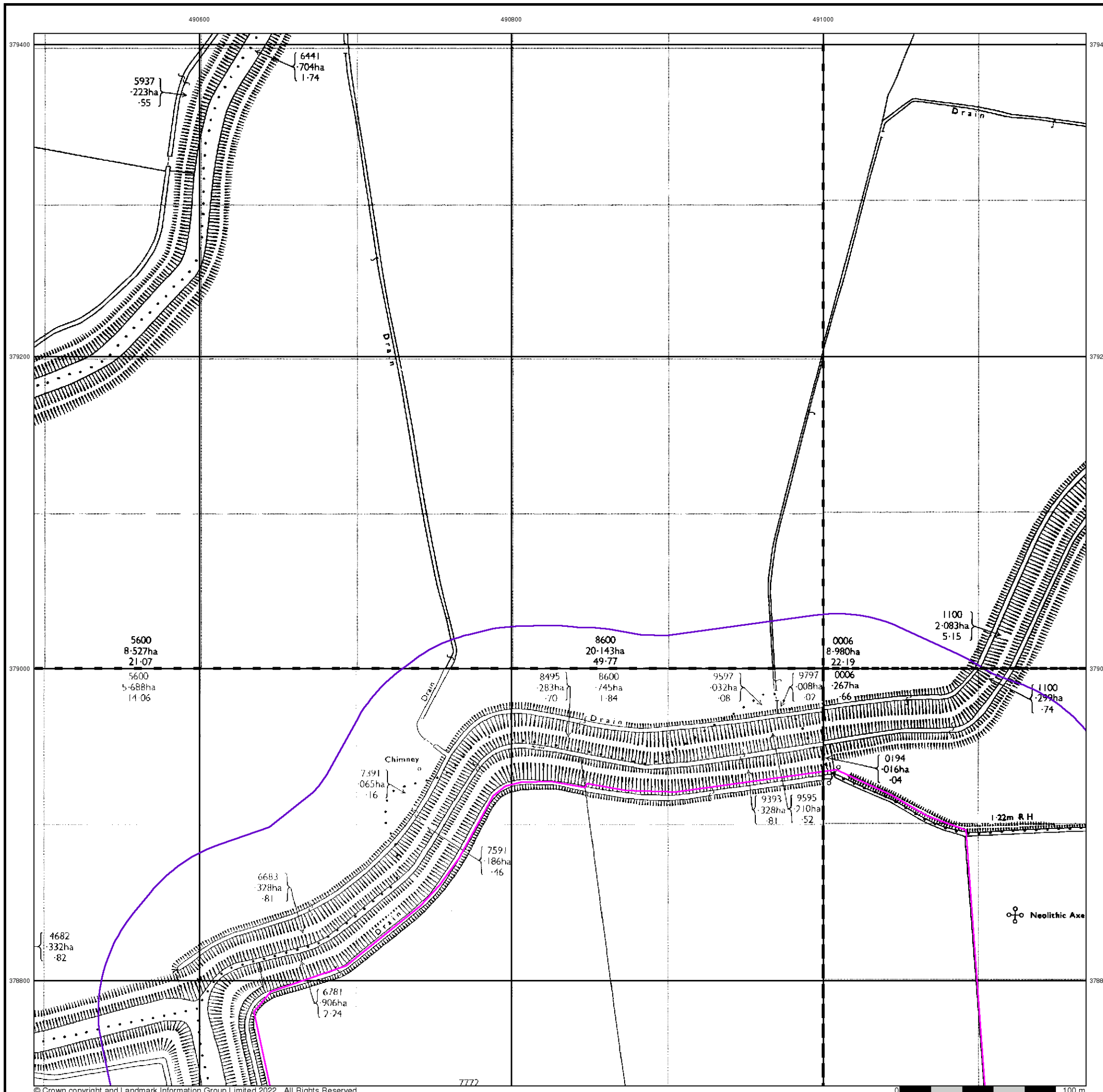

Additional SIMs

Published 1993

Source map scale - 1:2,500

The SIM cards (Ordnance Survey's 'Survey of Information on Microfilm') are further, minor editions of mapping which were produced and published in between the main editions as an area was updated. They date from 1947 to 1994, and contain detailed information on buildings, roads and land-use. These maps were produced at both 1:2,500 and 1:1,250 scales.

Map Name(s) and Date(s)

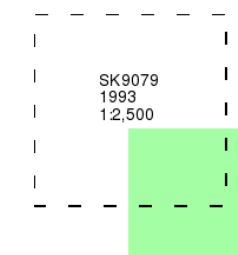

Historical Map - Segment D13

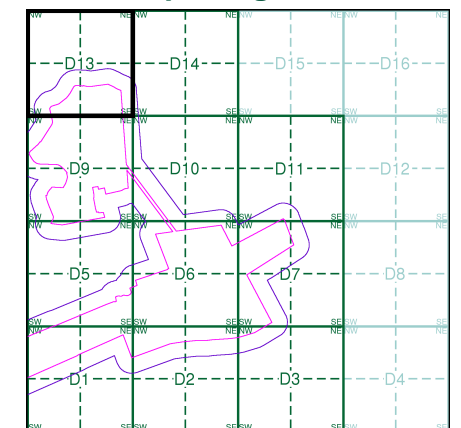

Order Details

Order Number: 298001007_1_1
 Customer Ref: 21-1098.04
 National Grid Reference: 491280, 377900
 Slice: D
 Site Area (Ha): 471.82
 Search Buffer (m): 100

Site Details

West Barton 1

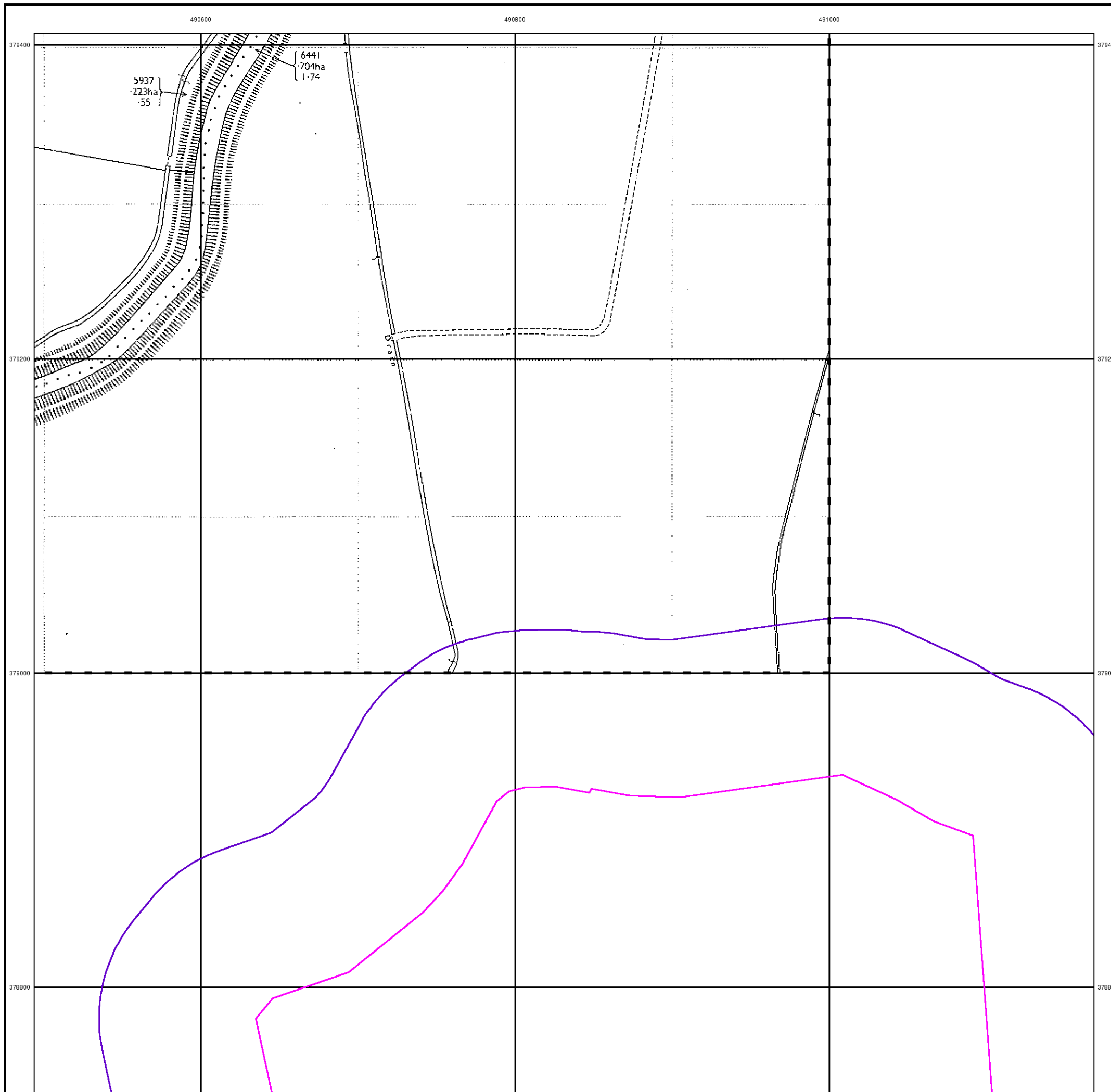

Large-Scale National Grid Data

Published 1994

Source map scale - 1:2,500

'Large Scale National Grid Data' superseded SIM cards (Ordnance Survey's 'Survey of Information on Microfilm') in 1992, and continued to be produced until 1999. These maps were the fore-runners of digital mapping and so provide detailed information on houses and roads, but tend to show less topographic features such as vegetation. These maps were produced at both 1:2,500 and 1:1,250 scales.

Map Name(s) and Date(s)

SK9079	SK9179
1994	1994
12,500	12,500
SK9078	SK9178
1994	1994
12,500	12,500

Historical Map - Segment D13

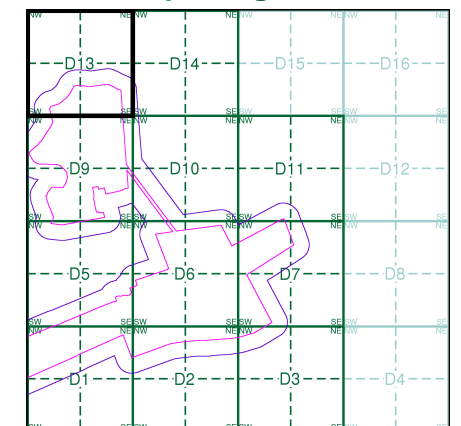

Order Details

Order Number: 298001007_1_1
 Customer Ref: 21-1098.04
 National Grid Reference: 491280, 377900
 Slice: D
 Site Area (Ha): 471.82
 Search Buffer (m): 100

Site Details

West Barton 1

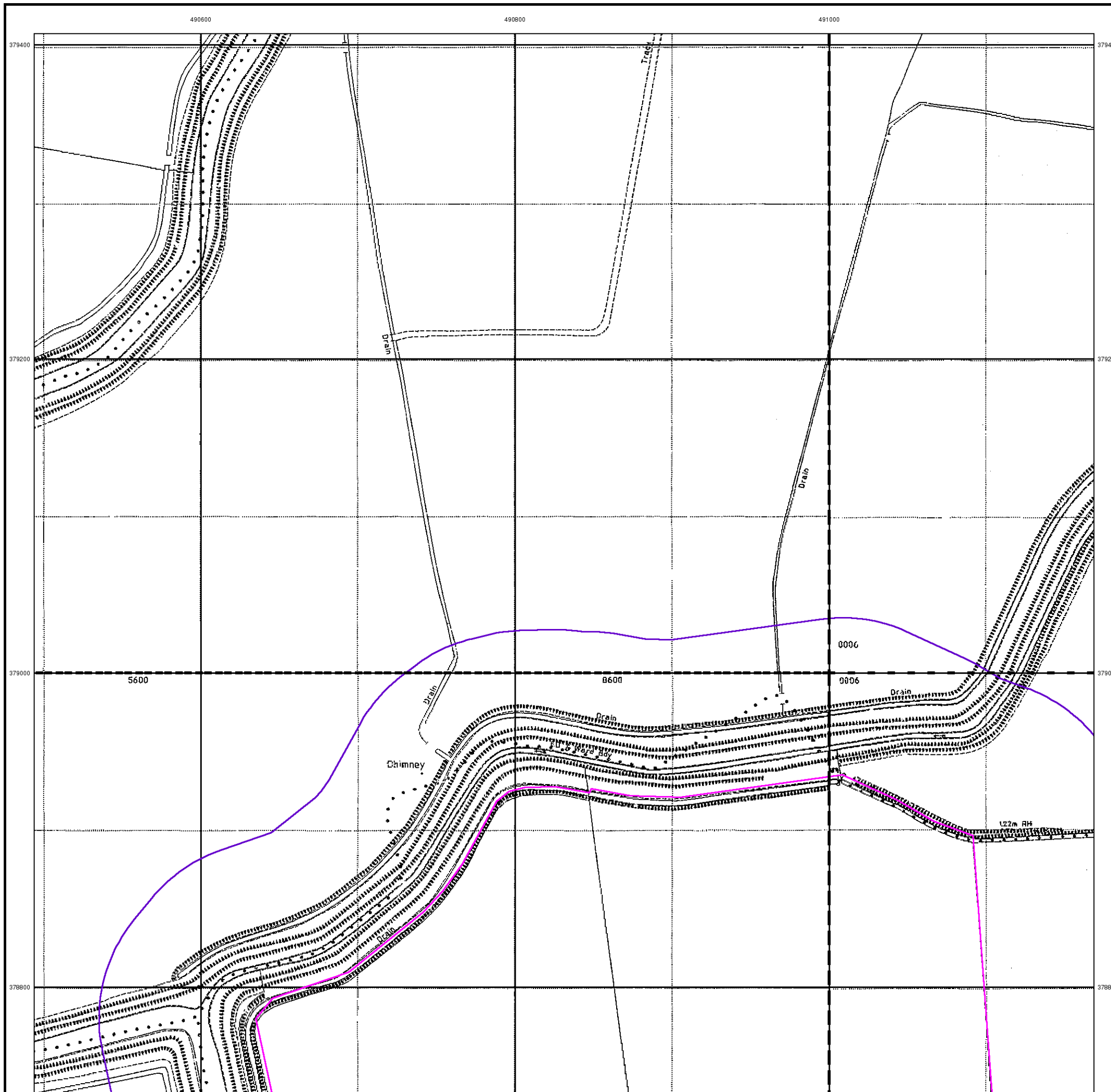

Historical Mapping Legends

Ordnance Survey County Series and Ordnance Survey Plan 1:2,500

Quarry **Gravel Pit** **Sand Pit**
Clay Pit **Shingle** **Refuse Heap**
Sloping Masonry **Flat Rock**
Marsh **Reeds** **Osiers**
Rough Pasture **Furze** **Wood**
Mixed Wood **Brushwood** **Orchard**
Fir **Ford** **Stepping Stones**
Ferry **Waterfall** **Lock**
Trig. Station **Altitude at Trig. Station**
B.M. 325.9 **Bench Mark** **Surface Level**
Arrow denotes flow of water **Antiquities (site of)**
Cutting **Embankment**
Railway crossing Road **Level Crossing** **Road crossing Railway**
Railway crossing River or Canal **Road over single stream** **Road over River or Canal**
County Boundary (Geographical)
County & Civil Parish Boundary
Administrative County & Civil Parish Boundary
County Borough Boundary (England)
County Burgh Boundary (Scotland)
Boundary Post or Stone **Police Call Box**
B.R. Bridle Road **Pump**
E.P. Electricity Pylon **S.P. Signal Post**
F.B. Foot Bridge **Sl. Sluice**
F.P. Foot Path **Sp. Spring**
G.P. Guide Post or Board **T.C.B. Telephone Call Box**
M.S. Mile Stone **Tr. Trough**
M.P. M.R. Mooring Post or Ring **W. Well**

Ordnance Survey Plan, Additional SIMs and Supply of Unpublished Survey Information 1:2,500 and 1:1,250

Inactive Quarry, Chalk Pit or Clay Pit **Active Quarry, Chalk Pit or Clay Pit**
Rock **Boulders**
Cliff **Slopes** **Top**
Roofed Building **Glazed Roof Building**
Sloping Masonry **Archway**
Non-Coniferous Tree (surveyed) **Coniferous Tree (surveyed)**
Non-Coniferous Trees (not surveyed) **Coniferous Trees (not surveyed)**
Orchard Tree **Scrub** **Bracken**
Coppice, Osier **Reeds** **Marsh, Saltings**
Rough Grassland **Heath** **Culvert**
Direction of water flow **Bench Mark** **Antiquity (site of)**
Cave Entrance **Triangulation Station** **Electricity Pylon**
Electricity Transmission Line
County Boundary (Geographical)
County & Civil Parish Boundary
Civil Parish Boundary
Admin. County or County Bor. Boundary
London Borough Boundary
Symbol marking point where boundary mereing changes
BH Beer House **P Pillar, Pole or Post**
BP, BS Boundary Post or Stone **PO Post Office**
Cn, C Capstan, Crane **PC Public Convenience**
Chy Chimney **PH Public House**
D Fn Drinking Fountain **Pp Pump**
EI P Electricity Pillar or Post **SB, S Br Signal Box or Bridge**
FAP Fire Alarm Pillar **SP, SL Signal Post or Light**
FB Foot Bridge **Spr Spring**
GP Guide Post **Tk Tank or Track**
H Hydrant or Hydraulic **TCB Telephone Call Box**
LC Level Crossing **TCP Telephone Call Post**
MH Manhole **Tr Trough**
MP Mile Post or Mooring Post **Wr Pt, Wr T Water Point, Water Tap**
MS Mile Stone **W Well**
NTL Normal Tidal Limit **Wd Pp Wind Pump**

Large-Scale National Grid Data 1:2,500 and 1:1,250

Cliff **Slopes** **Top**
Rock **Rock (scattered)**
Boulders **Boulders (scattered)**
Positioned Boulder **Scree**
Non-Coniferous Tree (surveyed) **Coniferous Tree (surveyed)**
Non-Coniferous Trees (not surveyed) **Coniferous Trees (not surveyed)**
Orchard Tree **Scrub** **Bracken**
Coppice, Osier **Reeds** **Marsh, Saltings**
Rough Grassland **Heath** **Culvert**
Direction of water flow **Triangulation Station** **Antiquity (site of)**
Electricity Transmission Line **Electricity Pylon**
Bench Mark **Buildings with Building Seed**
Roofed Building **Glazed Roof Building**
Civil parish/community boundary
District boundary
County boundary
Boundary post/stone
Boundary mereing symbol (note: these always appear in opposed pairs or groups of three)
Bks Barracks **P Pillar, Pole or Post**
Bty Battery **PO Post Office**
Cemy Cemetery **PC Public Convenience**
Chy Chimney **Pp Pump**
Cis Cistern **Ppg Sta Pumping Station**
Dismtd Rly Dismantled Railway **PW Place of Worship**
EI Gen Sta Electricity Generating Station **Sewage Ppg Sta Sewage Pumping Station**
EI P Electricity Pole, Pillar **SB, S Br Signal Box or Bridge**
EI Sub Sta Electricity Sub Station **SP, SL Signal Post or Light**
FB Filter Bed **Spr Spring**
Fn / D Fn Fountain / Drinking Ftn. **Tk Tank or Track**
Gas Gov Gas Valve Compound **Tr Trough**
GVC Gas Governor **Wd Pp Wind Pump**
GP Guide Post **Wr Pt, Wr T Water Point, Water Tap**
MH Manhole **Wks Works (building or area)**
MP, MS Mile Post or Mile Stone **W Well**

Historical Mapping & Photography included:

Mapping Type	Scale	Date	Pg
Lincolnshire	1:2,500	1886	2
Lincolnshire	1:2,500	1906	3
Ordnance Survey Plan	1:2,500	1973 - 1974	4
Large-Scale National Grid Data	1:2,500	1994	5

Historical Map - Segment D14

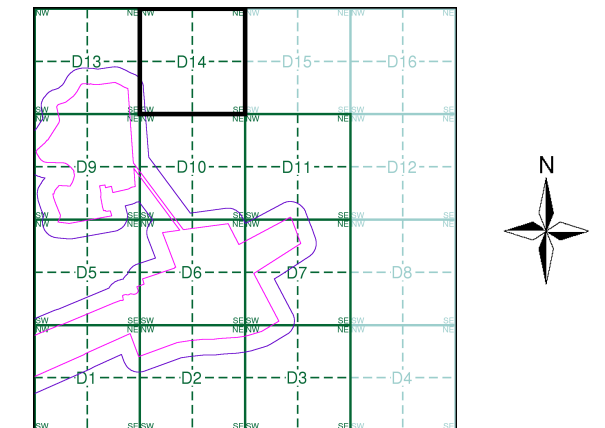

Order Details

Order Number: 298001007_1_1
 Customer Ref: 21-1098.04
 National Grid Reference: 491280, 377900
 Slice: D
 Site Area (Ha): 471.82
 Search Buffer (m): 100

Site Details

West Barton 1

Lincolnshire

Published 1886

Source map scale - 1:2,500

The historical maps shown were reproduced from maps predominantly held at the scale adopted for England, Wales and Scotland in the 1840's. In 1854 the 1:2,500 scale was adopted for mapping urban areas and by 1896 it covered the whole of what were considered to be the cultivated parts of Great Britain. The published date given below is often some years later than the surveyed date. Before 1938, all OS maps were based on the Cassini Projection, with independent surveys of a single county or group of counties, giving rise to significant inaccuracies in outlying areas.

Map Name(s) and Date(s)

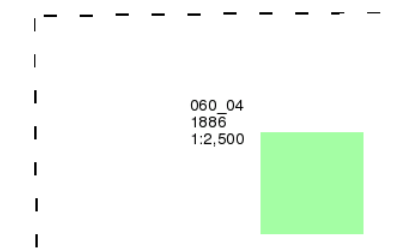

Historical Map - Segment D14

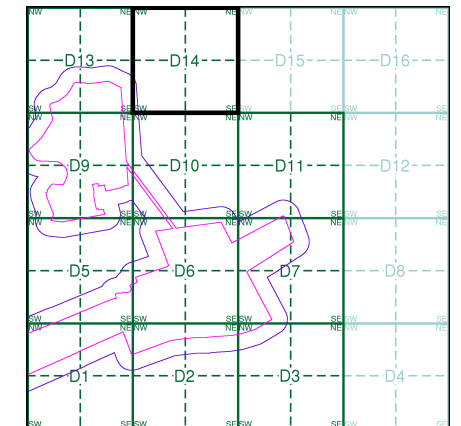

Order Details

Order Number: 298001007_1_1
 Customer Ref: 21-1098.04
 National Grid Reference: 491280, 377900
 Slice: D
 Site Area (Ha): 471.82
 Search Buffer (m): 100

Site Details

West Barton 1

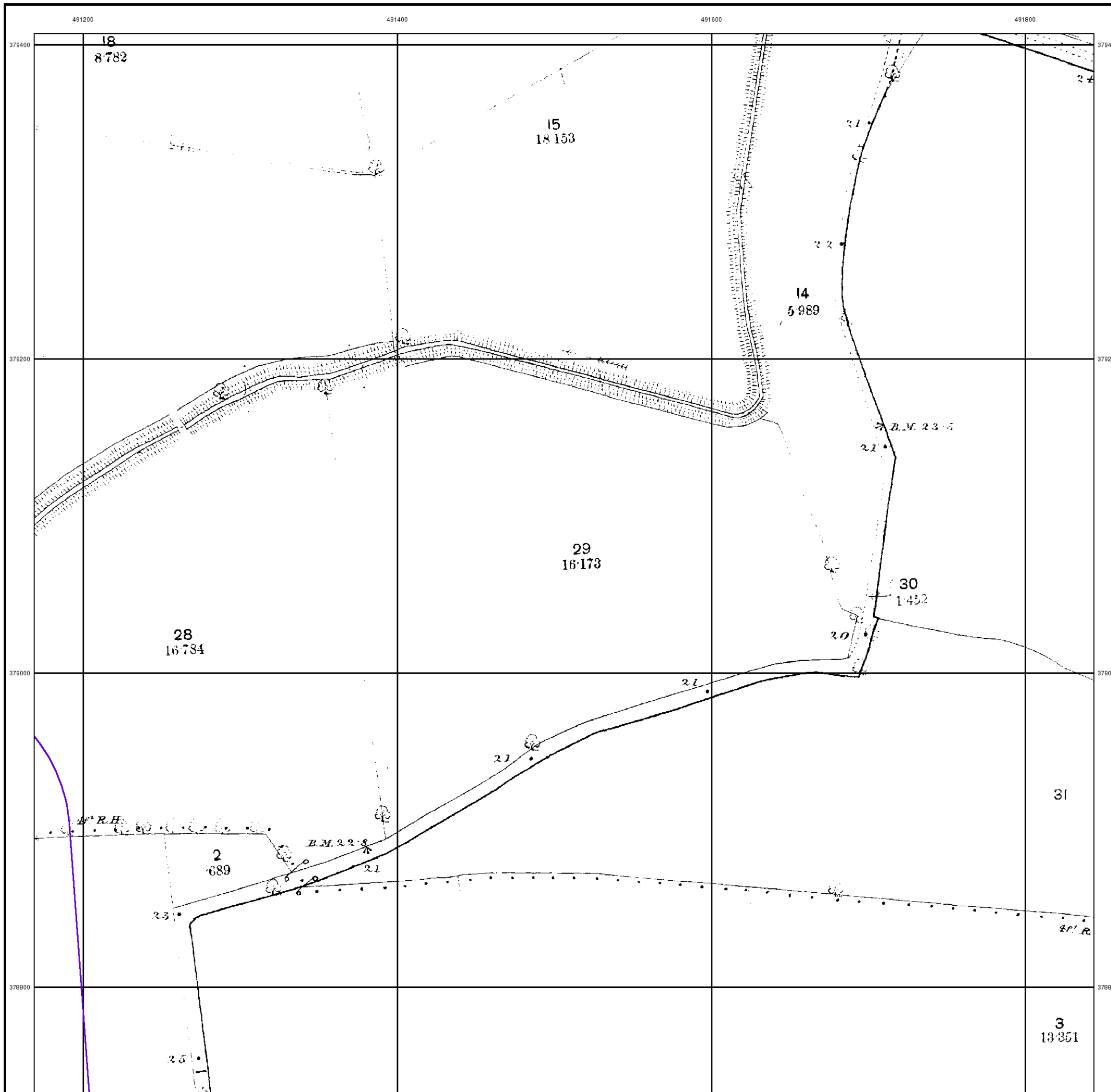

Lincolnshire

Published 1906

Source map scale - 1:2,500

The historical maps shown were reproduced from maps predominantly held at the scale adopted for England, Wales and Scotland in the 1840's. In 1854 the 1:2,500 scale was adopted for mapping urban areas and by 1896 it covered the whole of what were considered to be the cultivated parts of Great Britain. The published date given below is often some years later than the surveyed date. Before 1938, all OS maps were based on the Cassini Projection, with independent surveys of a single county or group of counties, giving rise to significant inaccuracies in outlying areas.

Map Name(s) and Date(s)

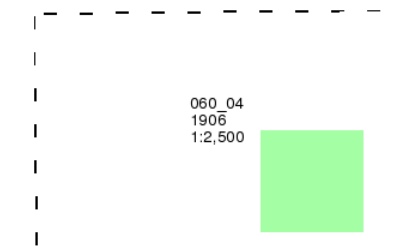

Historical Map - Segment D14

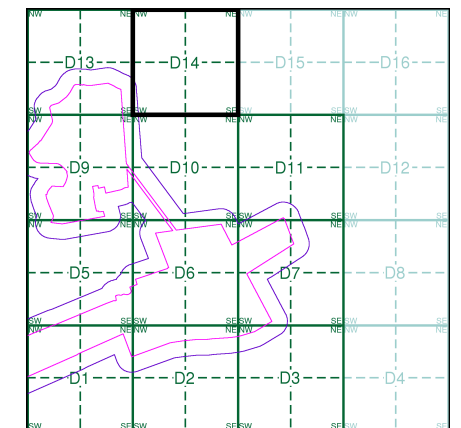

Order Details

Order Number: 298001007_1_1
 Customer Ref: 21-1098.04
 National Grid Reference: 491280, 377900
 Slice: D
 Site Area (Ha): 471.82
 Search Buffer (m): 100

Site Details

West Barton 1

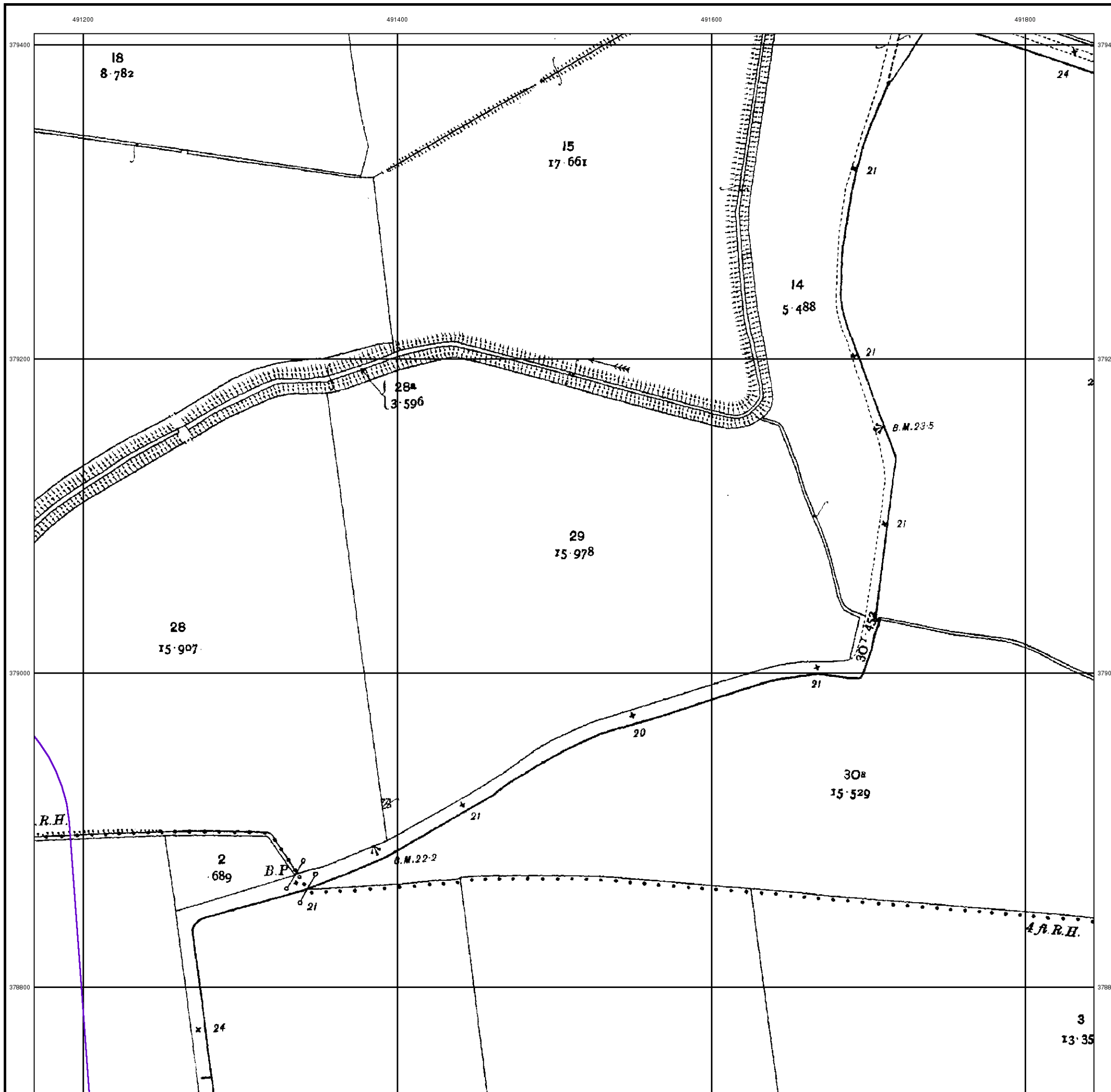

Ordnance Survey Plan
Published 1973 - 1974
Source map scale - 1:2,500

The historical maps shown were reproduced from maps predominantly held at the scale adopted for England, Wales and Scotland in the 1840's. In 1854 the 1:2,500 scale was adopted for mapping urban areas and by 1896 it covered the whole of what were considered to be the cultivated parts of Great Britain. The published date given below is often some years later than the surveyed date. Before 1938, all OS maps were based on the Cassini Projection, with independent surveys of a single county or group of counties, giving rise to significant inaccuracies in outlying areas.

Map Name(s) and Date(s)

SK9179	1973	1:2,500
SK9178	1974	1:2,500

Historical Map - Segment D14

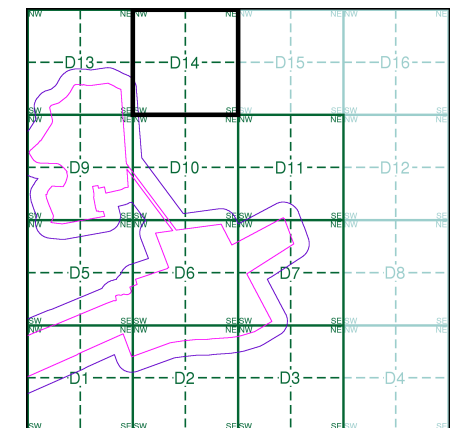

Order Details

Order Number: 298001007_1_1
 Customer Ref: 21-1098.04
 National Grid Reference: 491280, 377900
 Slice: D
 Site Area (Ha): 471.82
 Search Buffer (m): 100

Site Details

West Barton 1

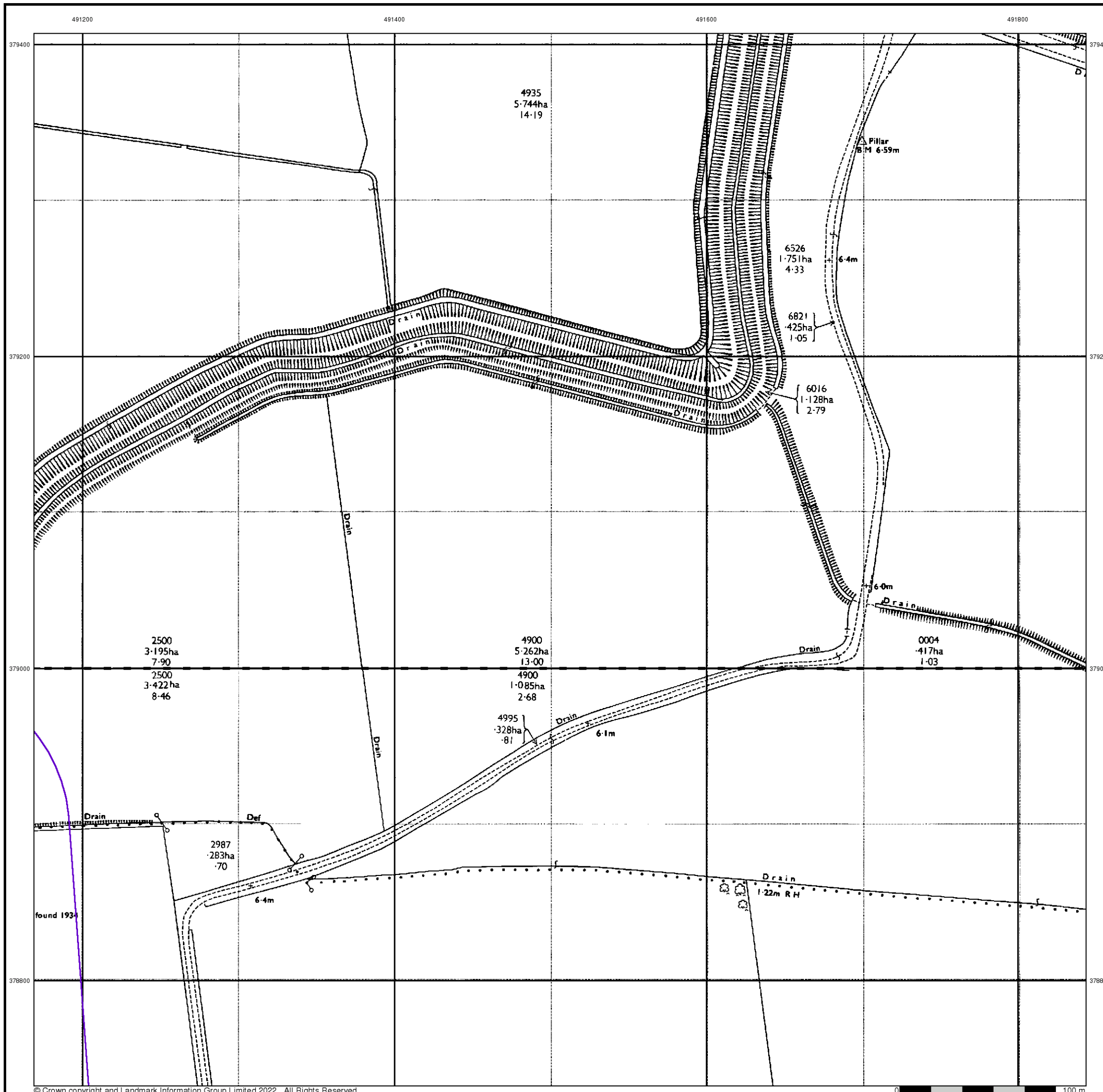

Large-Scale National Grid Data
Published 1994
Source map scale - 1:2,500

'Large Scale National Grid Data' superseded SIM cards (Ordnance Survey's 'Survey of Information on Microfilm') in 1992, and continued to be produced until 1999. These maps were the fore-runners of digital mapping and so provide detailed information on houses and roads, but tend to show less topographic features such as vegetation. These maps were produced at both 1:2,500 and 1:1,250 scales.

Map Name(s) and Date(s)

SK9179	1994	1:2,500
SK9178	1994	1:2,500

Historical Map - Segment D14

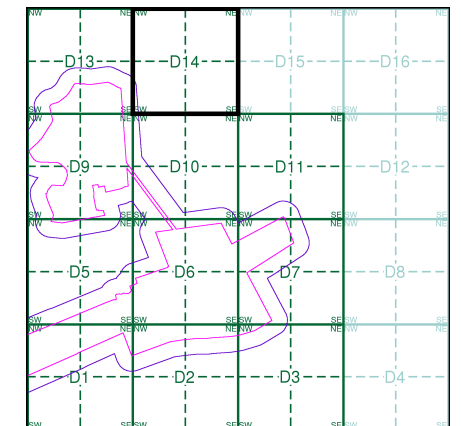

Order Details

Order Number: 298001007_1_1
 Customer Ref: 21-1098.04
 National Grid Reference: 491280, 377900
 Slice: D
 Site Area (Ha): 471.82
 Search Buffer (m): 100

Site Details

West Barton 1



Historical Mapping Legends

Ordnance Survey County Series 1:10,560

- Gravel Pit
- Sand Pit
- Other Pits
- Quarry
- Shingle
- Orchard
- Osiers
- Reeds
- Marsh
- Mixed Wood
- Deciduous
- Brushwood
- Fir
- Furze
- Rough Pasture
- Arrow denotes flow of water
- Trigonometrical Station
- Site of Antiquities
- Bench Mark
- Pump, Guide Post, Signal Post
- Well, Spring, Boundary Post
- 285** Surface Level
- Sketched Contour
- Instrumental Contour
- Main Roads (Fenced, Un-Fenced)
- Minor Roads (Fenced, Un-Fenced)
- Sunken Road
- Raised Road
- Road over Railway
- Railway over River
- Railway over Road
- Level Crossing
- Road over River or Canal
- Road over Stream
- Road over Stream
- County Boundary (Geographical)
- County & Civil Parish Boundary
- Administrative County & Civil Parish Boundary
- County Borough Boundary (England)
- County Burgh Boundary (Scotland)
- Rural District Boundary
- Civil Parish Boundary

Ordnance Survey Plan 1:10,000

- Chalk Pit, Clay Pit or Quarry
- Gravel Pit
- Sand Pit
- Disused Pit or Quarry
- Refuse or Slag Heap
- Lake, Loch or Pond
- Dunes
- Boulders
- Coniferous Trees
- Non-Coniferous Trees
- Orchard
- Scrub
- Coppice
- Bracken
- Heath
- Rough Grassland
- Marsh
- Reeds
- Saltings
- Building
- Glasshouse
- Sloping Masonry
- Pylon
- Electricity Transmission Line
- Pole
- Cutting
- Embankment
- Standard Gauge Multiple Track
- Road Under
- Road Over
- Level Crossing
- Foot Bridge
- Standard Gauge Single Track
- Siding, Tramway or Mineral Line
- Narrow Gauge
- Geographical County
- Administrative County, County Borough or County of City
- Municipal Borough, Urban or Rural District, Burgh or District Council
- Borough, Burgh or County Constituency (Shown only when not coincident with other boundaries)
- Civil Parish (Shown alternately when coincidence of boundaries occurs)
- BP, BS Boundary Post or Stone
- Ch Church
- CH Club House
- F E Sta Fire Engine Station
- FB Foot Bridge
- Fn Fountain
- GP Guide Post
- MP Mile Post
- MS Mile Stone
- Pol Sta Police Station
- PO Post Office
- PC Public Convenience
- PH Public House
- SB Signal Box
- Spr Spring
- TCB Telephone Call Box
- TCP Telephone Call Post
- W Well

1:10,000 Raster Mapping

- Gravel Pit
- Refuse tip or slag heap
- Rock
- Rock (scattered)
- Boulders
- Boulders (scattered)
- Shingle
- Mud
- Mud
- Sand
- Sand Pit
- Slopes
- Top of cliff
- General detail
- Underground detail
- Overhead detail
- Narrow gauge railway
- Multi-track railway
- Single track railway
- County boundary (England only)
- Civil, parish or community boundary
- District, Unitary, Metropolitan, London Borough boundary
- Constituency boundary
- Area of wooded vegetation
- Non-coniferous trees
- Non-coniferous trees (scattered)
- Coniferous trees
- Coniferous trees (scattered)
- Positioned tree
- Orchard
- Coppice or Osiers
- Rough Grassland
- Heath
- Scrub
- Marsh, Salt Marsh or Reeds
- Water feature
- Flow arrows
- MHW(S) Mean high water (springs)
- MLW(S) Mean low water (springs)
- Telephone line (where shown)
- Electricity transmission line (with poles)
- Bench mark (where shown)
- Triangulation station
- Point feature (e.g. Guide Post or Mile Stone)
- Pylon, flare stack or lighting tower
- Site of (antiquity)
- Glasshouse
- General Building
- Important Building



Historical Mapping & Photography included:

Mapping Type	Scale	Date	Pg
Lincolnshire	1:10,560	1885	2
Nottinghamshire	1:10,560	1885	3
Nottinghamshire	1:10,560	1900	4
Lincolnshire	1:10,560	1906	5
Lincolnshire	1:10,560	1921 - 1922	6
Lincolnshire	1:10,560	1922	7
Lincolnshire	1:10,560	1947	8
Ordnance Survey Plan	1:10,000	1956	9
Ordnance Survey Plan	1:10,000	1974 - 1979	10
Ordnance Survey Plan	1:10,000	1980 - 1981	11
10K Raster Mapping	1:10,000	2000	12
Street View	Variable		13

Historical Map - Slice E

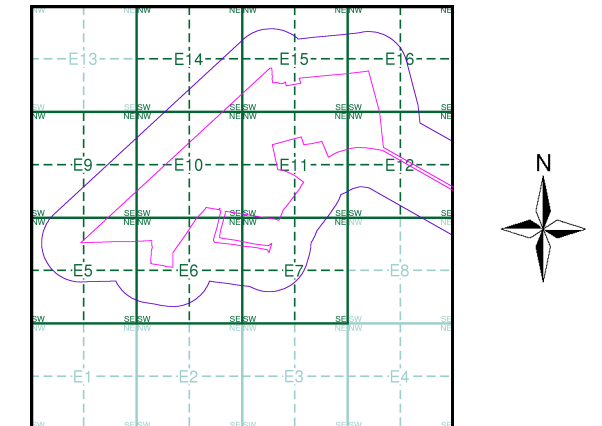

Order Details

Order Number: 298001007_1_1
 Customer Ref: 21-1098.04
 National Grid Reference: 483820, 381060
 Slice: E
 Site Area (Ha): 471.82
 Search Buffer (m): 250

Site Details

West Barton 1



Tel: 0844 844 9952
 Fax: 0844 844 9951
 Web: [REDACTED]

Lincolnshire

Published 1885

Source map scale - 1:10,560

The historical maps shown were reproduced from maps predominantly held at the scale adopted for England, Wales and Scotland in the 1840's. In 1854 the 1:2,500 scale was adopted for mapping urban areas; these maps were used to update the 1:10,560 maps. The published date given therefore is often some years later than the surveyed date. Before 1938, all OS maps were based on the Cassini Projection, with independent surveys of a single county or group of counties, giving rise to significant inaccuracies in outlying areas. In the late 1940's, a Provisional Edition was produced, which updated the 1:10,560 mapping from a number of sources. The maps appear unfinished - with all military camps and other strategic sites removed. These maps were initially overprinted with the National Grid. In 1970, the first 1:10,000 maps were produced using the Transverse Mercator Projection. The revision process continued until recently, with new editions appearing every 10 years or so for urban areas.

Map Name(s) and Date(s)

051SW	1885	1:10,560
060NW	1885	1:10,560

Historical Map - Slice E

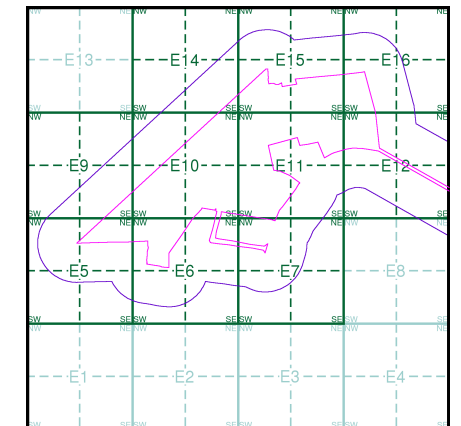

Order Details

Order Number: 298001007_1_1
 Customer Ref: 21-1098.04
 National Grid Reference: 483820, 381060
 Slice: E
 Site Area (Ha): 471.82
 Search Buffer (m): 250

Site Details

West Barton 1

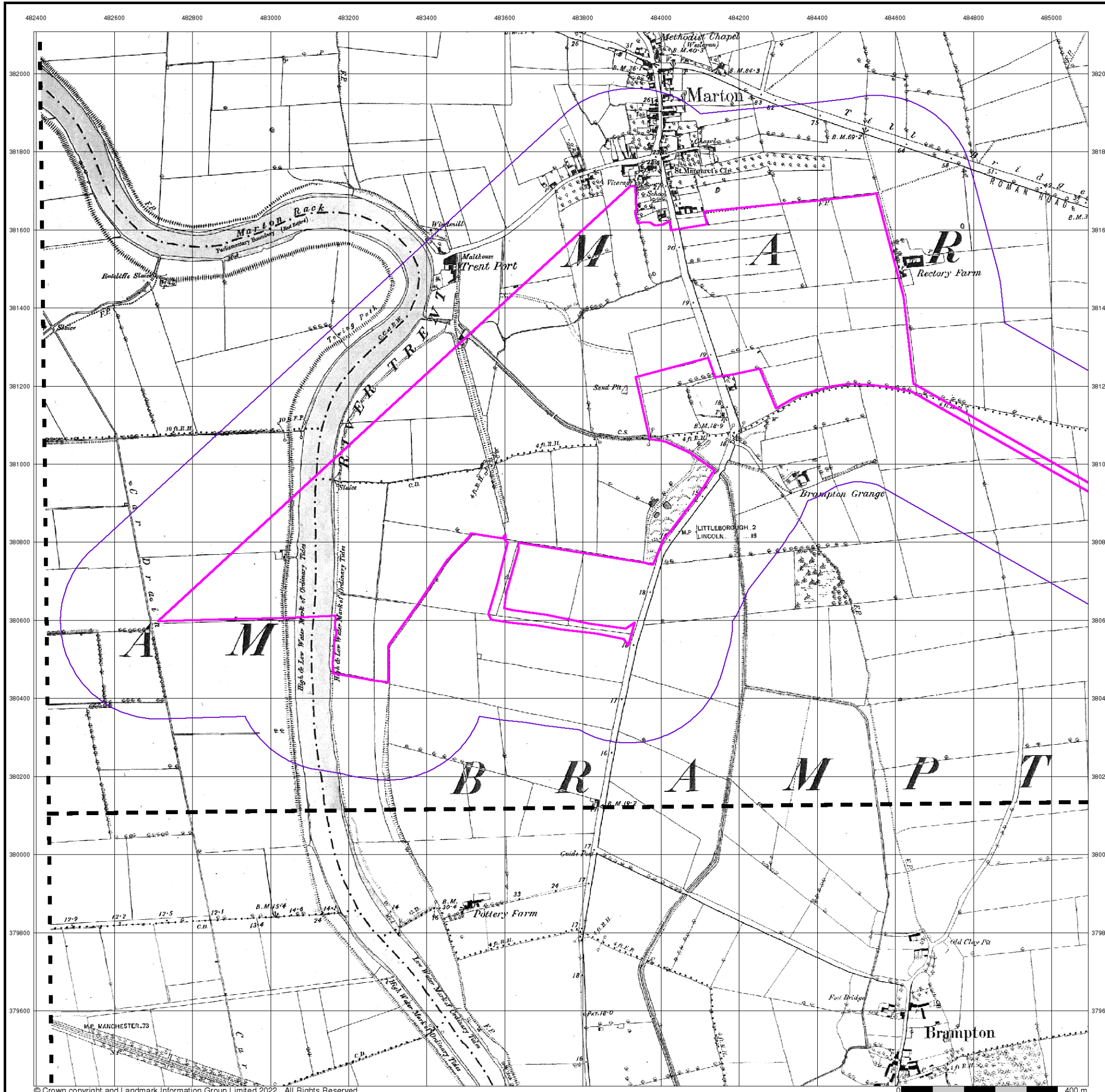

Nottinghamshire

Published 1885

Source map scale - 1:10,560

The historical maps shown were reproduced from maps predominantly held at the scale adopted for England, Wales and Scotland in the 1840's. In 1854 the 1:2,500 scale was adopted for mapping urban areas; these maps were used to update the 1:10,560 maps. The published date given therefore is often some years later than the surveyed date. Before 1938, all OS maps were based on the Cassini Projection, with independent surveys of a single county or group of counties, giving rise to significant inaccuracies in outlying areas. In the late 1940's, a Provisional Edition was produced, which updated the 1:10,560 mapping from a number of sources. The maps appear unfinished - with all military camps and other strategic sites removed. These maps were initially overprinted with the National Grid. In 1970, the first 1:10,000 maps were produced using the Transverse Mercator Projection. The revision process continued until recently, with new editions appearing every 10 years or so for urban areas.

Map Name(s) and Date(s)

010SE 1885 1:10,560	
015NE 1885 1:10,560	

Historical Map - Slice E

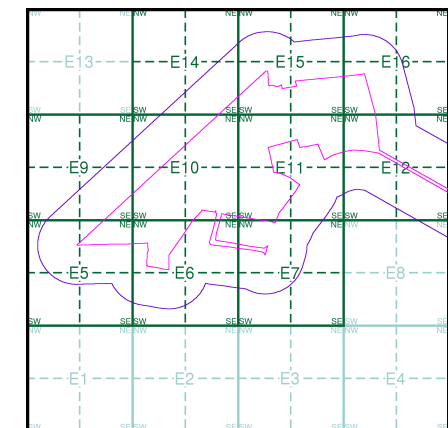

Order Details

Order Number: 298001007_1_1
 Customer Ref: 21-1098.04
 National Grid Reference: 483820, 381060
 Slice: E
 Site Area (Ha): 471.82
 Search Buffer (m): 250

Site Details

West Barton 1

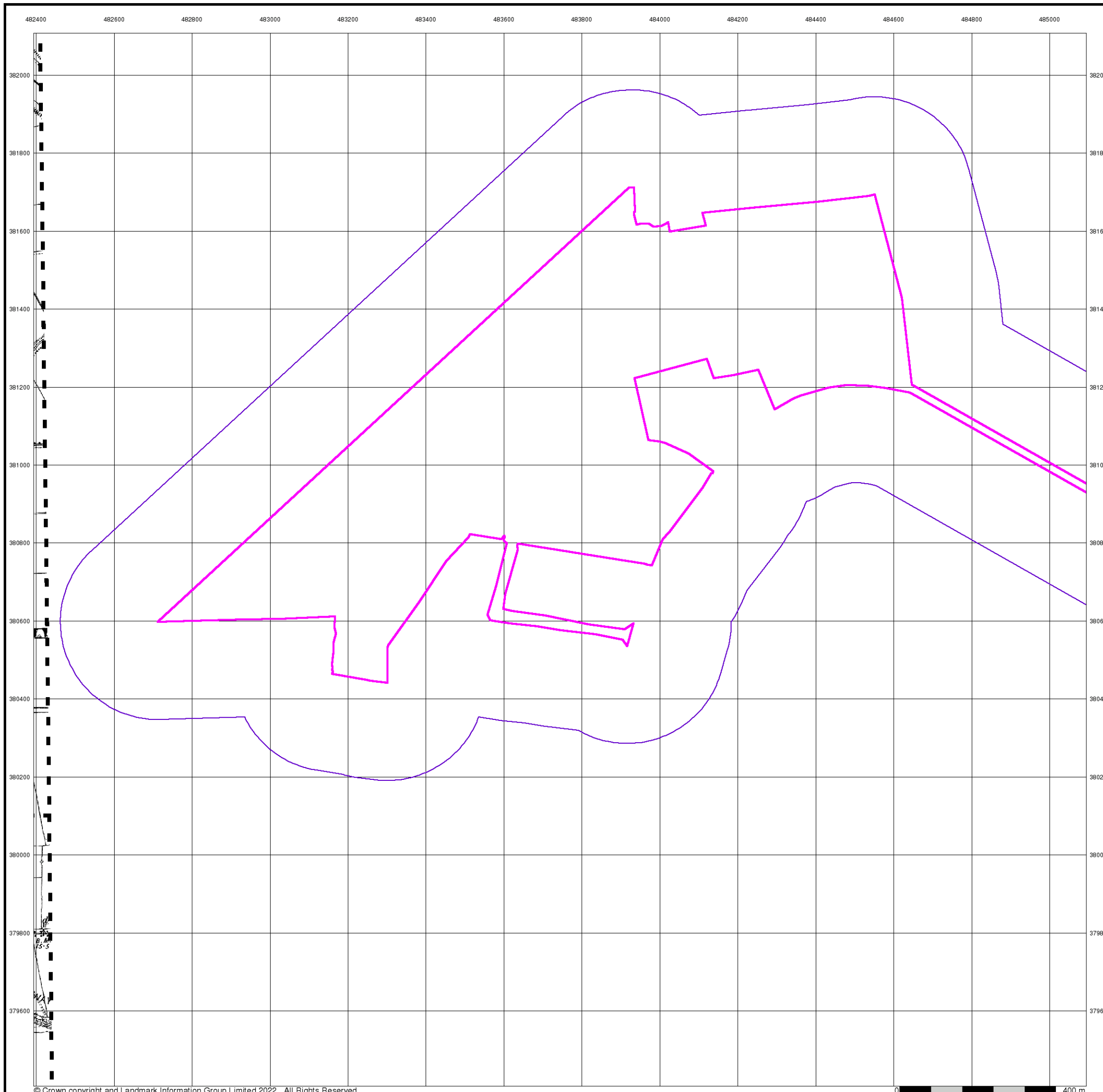

Nottinghamshire

Published 1900

Source map scale - 1:10,560

The historical maps shown were reproduced from maps predominantly held at the scale adopted for England, Wales and Scotland in the 1840's. In 1854 the 1:2,500 scale was adopted for mapping urban areas; these maps were used to update the 1:10,560 maps. The published date given therefore is often some years later than the surveyed date. Before 1938, all OS maps were based on the Cassini Projection, with independent surveys of a single county or group of counties, giving rise to significant inaccuracies in outlying areas. In the late 1940's, a Provisional Edition was produced, which updated the 1:10,560 mapping from a number of sources. The maps appear unfinished - with all military camps and other strategic sites removed. These maps were initially overprinted with the National Grid. In 1970, the first 1:10,000 maps were produced using the Transverse Mercator Projection. The revision process continued until recently, with new editions appearing every 10 years or so for urban areas.

Map Name(s) and Date(s)

010SE 1900 1:10,560	011SW 1900 1:10,560
015NE 1900 1:10,560	016NW 1900 1:10,560

Historical Map - Slice E

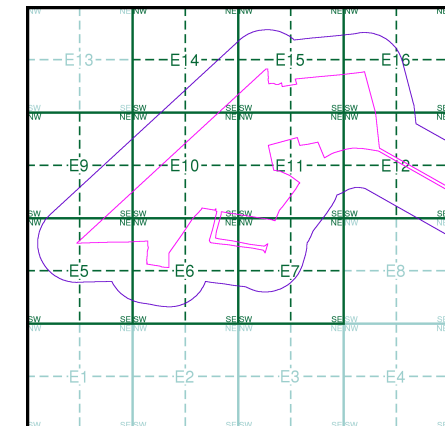

Order Details

Order Number: 298001007_1_1
 Customer Ref: 21-1098.04
 National Grid Reference: 483820, 381060
 Slice: E
 Site Area (Ha): 471.82
 Search Buffer (m): 250

Site Details

West Barton 1

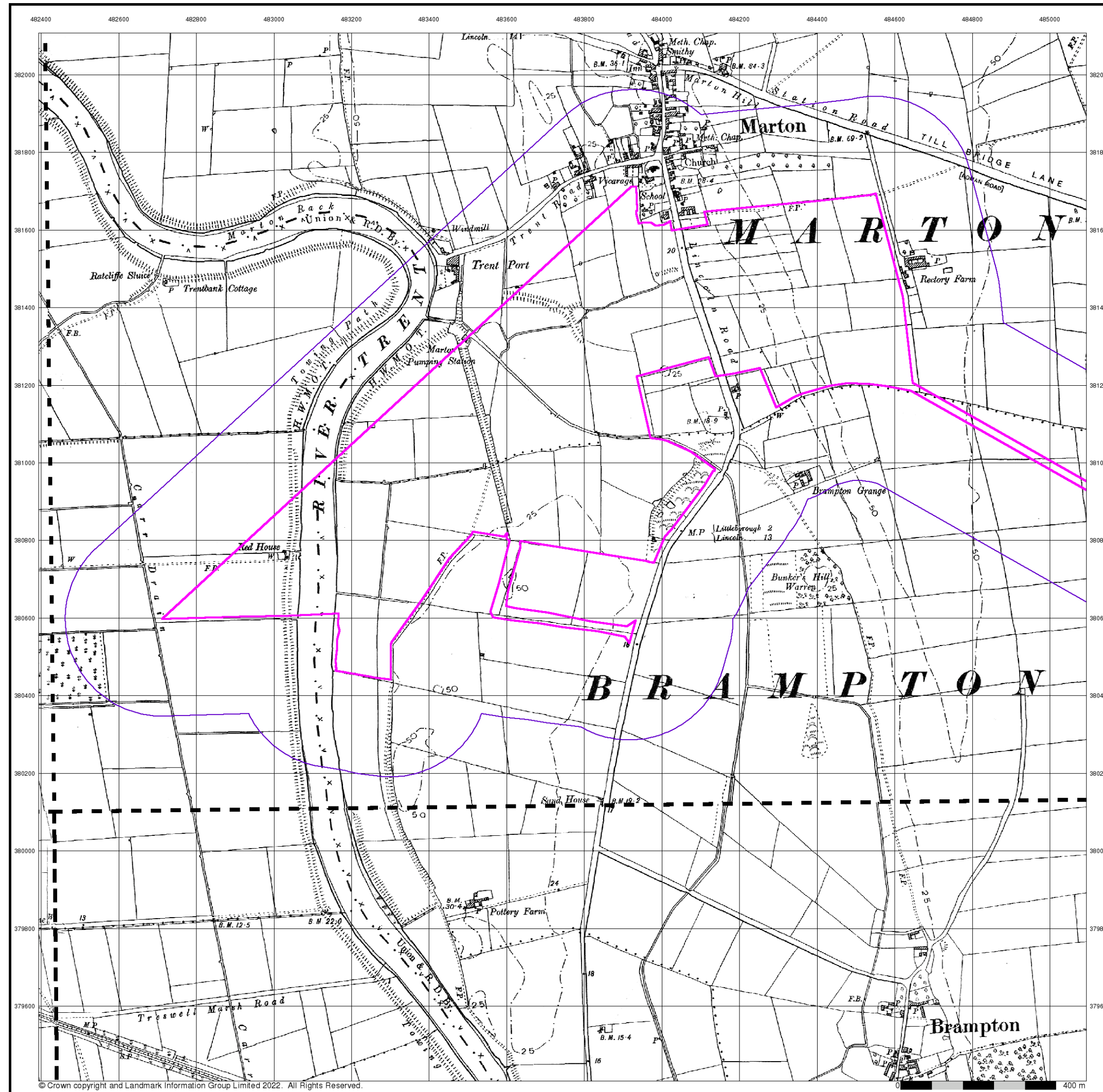

Lincolnshire

Published 1906

Source map scale - 1:10,560

The historical maps shown were reproduced from maps predominantly held at the scale adopted for England, Wales and Scotland in the 1840's. In 1854 the 1:2,500 scale was adopted for mapping urban areas; these maps were used to update the 1:10,560 maps. The published date given therefore is often some years later than the surveyed date. Before 1938, all OS maps were based on the Cassini Projection, with independent surveys of a single county or group of counties, giving rise to significant inaccuracies in outlying areas. In the late 1940's, a Provisional Edition was produced, which updated the 1:10,560 mapping from a number of sources. The maps appear unfinished - with all military camps and other strategic sites removed. These maps were initially overprinted with the National Grid. In 1970, the first 1:10,000 maps were produced using the Transverse Mercator Projection. The revision process continued until recently, with new editions appearing every 10 years or so for urban areas.

Map Name(s) and Date(s)

051SW	1906
060NW	1906

Historical Map - Slice E

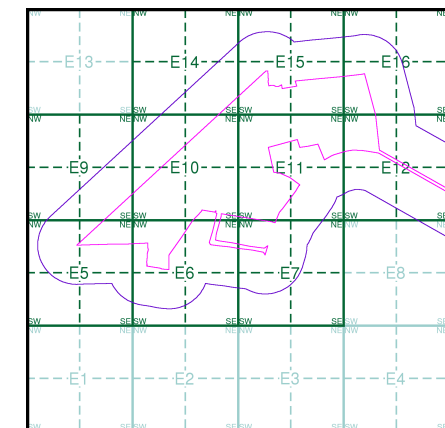

Order Details

Order Number: 298001007_1_1
 Customer Ref: 21-1098.04
 National Grid Reference: 483820, 381060
 Slice: E
 Site Area (Ha): 471.82
 Search Buffer (m): 250

Site Details

West Barton 1

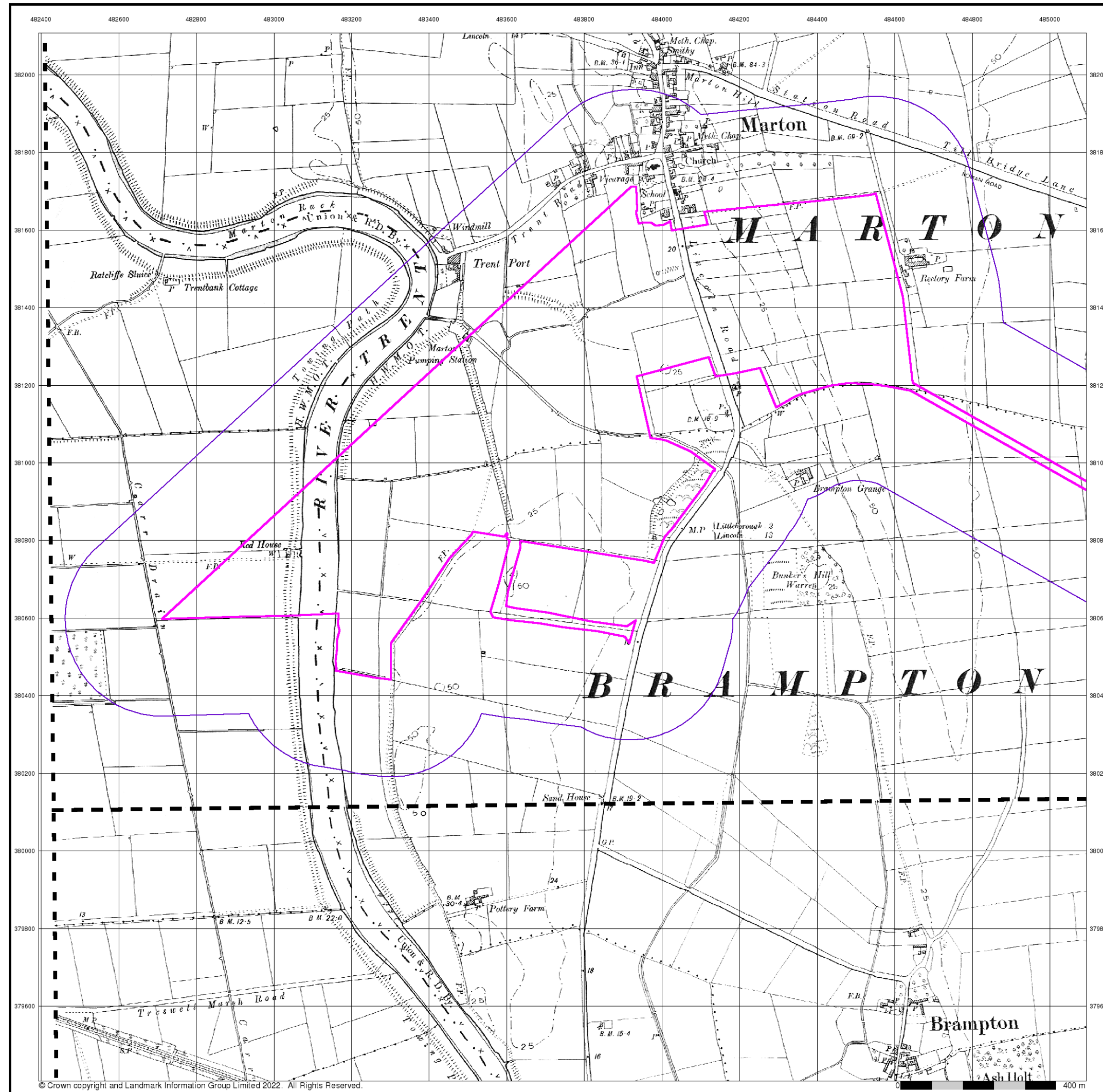

Lincolnshire

Published 1921 - 1922

Source map scale - 1:10,560

The historical maps shown were reproduced from maps predominantly held at the scale adopted for England, Wales and Scotland in the 1840's. In 1854 the 1:2,500 scale was adopted for mapping urban areas; these maps were used to update the 1:10,560 maps. The published date given therefore is often some years later than the surveyed date. Before 1938, all OS maps were based on the Cassini Projection, with independent surveys of a single county or group of counties, giving rise to significant inaccuracies in outlying areas. In the late 1940's, a Provisional Edition was produced, which updated the 1:10,560 mapping from a number of sources. The maps appear unfinished - with all military camps and other strategic sites removed. These maps were initially overprinted with the National Grid. In 1970, the first 1:10,000 maps were produced using the Transverse Mercator Projection. The revision process continued until recently, with new editions appearing every 10 years or so for urban areas.

Map Name(s) and Date(s)

050SE 1922 1:10,560	051SW 1922 1:10,560
059NE 1921 1:10,560	060NW 1922 1:10,560

Historical Map - Slice E

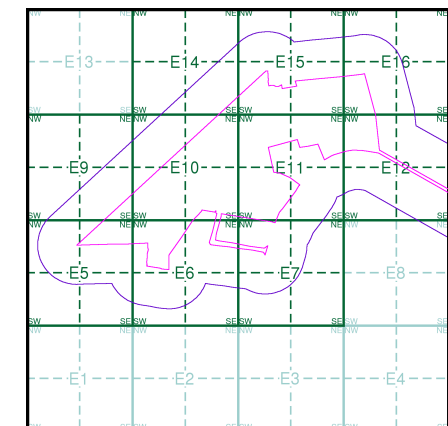

Order Details

Order Number: 298001007_1_1
 Customer Ref: 21-1098.04
 National Grid Reference: 483820, 381060
 Slice: E
 Site Area (Ha): 471.82
 Search Buffer (m): 250

Site Details

West Barton 1

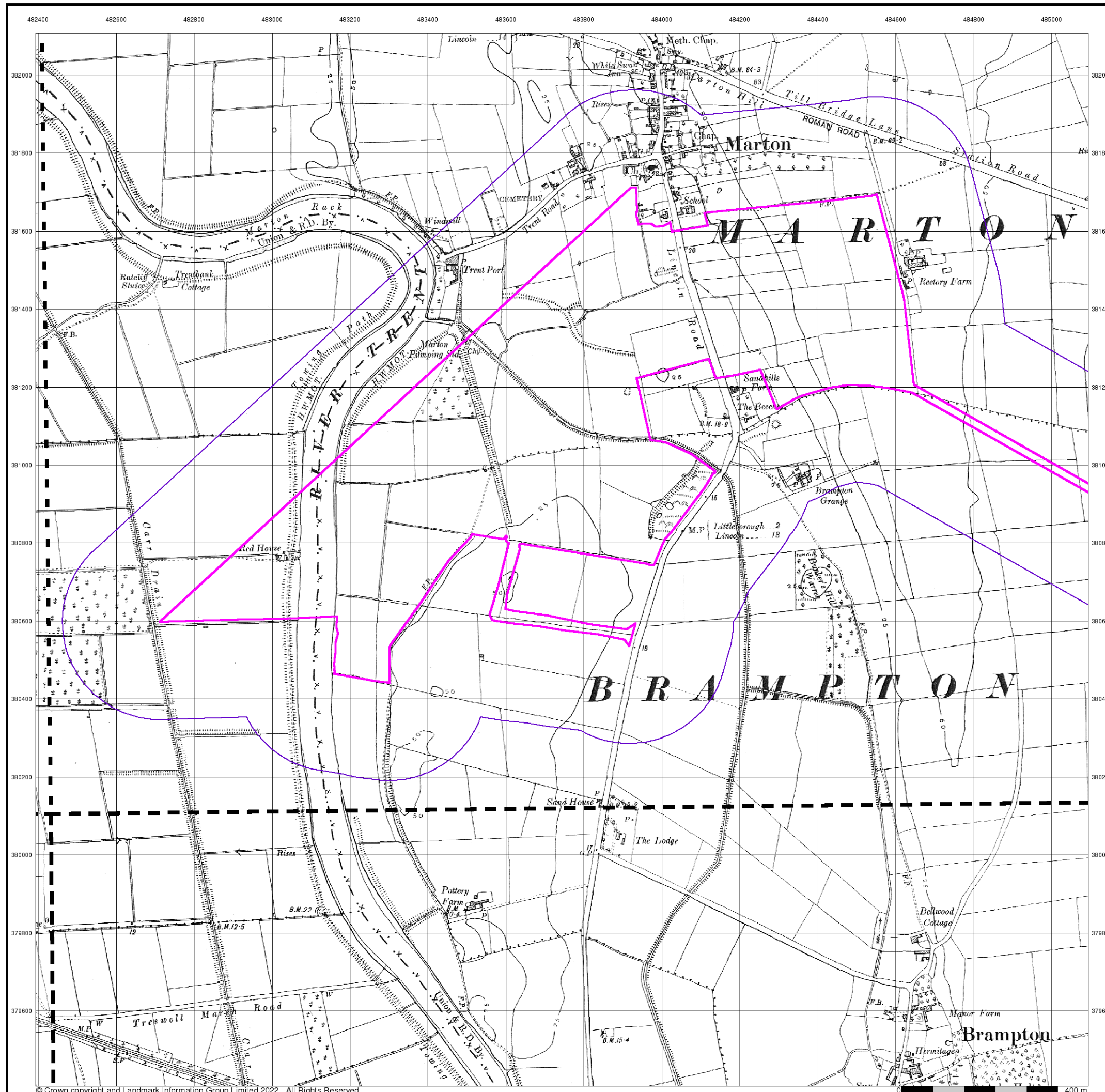

Lincolnshire

Published 1922

Source map scale - 1:10,560

The historical maps shown were reproduced from maps predominantly held at the scale adopted for England, Wales and Scotland in the 1840's. In 1854 the 1:2,500 scale was adopted for mapping urban areas; these maps were used to update the 1:10,560 maps. The published date given therefore is often some years later than the surveyed date. Before 1938, all OS maps were based on the Cassini Projection, with independent surveys of a single county or group of counties, giving rise to significant inaccuracies in outlying areas. In the late 1940's, a Provisional Edition was produced, which updated the 1:10,560 mapping from a number of sources. The maps appear unfinished - with all military camps and other strategic sites removed. These maps were initially overprinted with the National Grid. In 1970, the first 1:10,000 maps were produced using the Transverse Mercator Projection. The revision process continued until recently, with new editions appearing every 10 years or so for urban areas.

Map Name(s) and Date(s)

051SW	1922
060NW	1922

Historical Map - Slice E

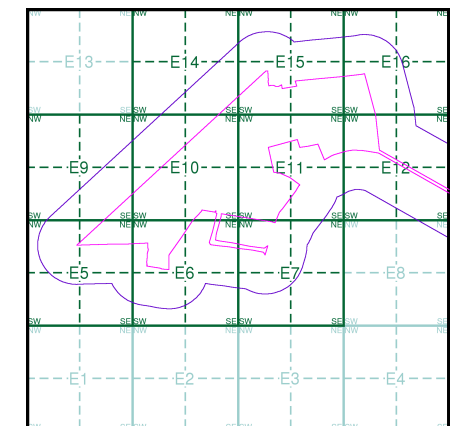

Order Details

Order Number: 298001007_1_1
 Customer Ref: 21-1098.04
 National Grid Reference: 483820, 381060
 Slice: E
 Site Area (Ha): 471.82
 Search Buffer (m): 250

Site Details

West Barton 1

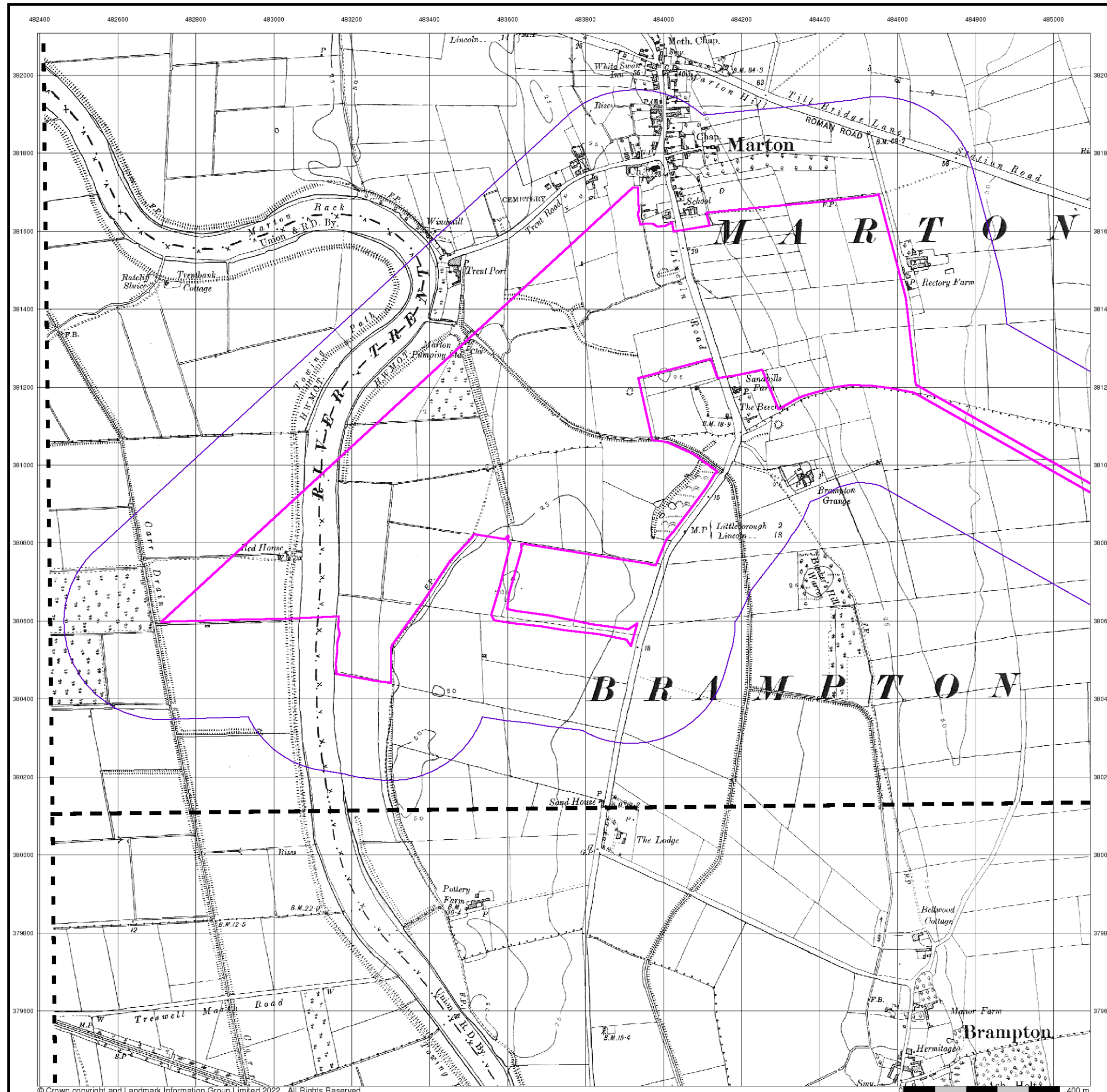

Lincolnshire

Published 1947

Source map scale - 1:10,560

The historical maps shown were reproduced from maps predominantly held at the scale adopted for England, Wales and Scotland in the 1840's. In 1854 the 1:2,500 scale was adopted for mapping urban areas; these maps were used to update the 1:10,560 maps. The published date given therefore is often some years later than the surveyed date. Before 1938, all OS maps were based on the Cassini Projection, with independent surveys of a single county or group of counties, giving rise to significant inaccuracies in outlying areas. In the late 1940's, a Provisional Edition was produced, which updated the 1:10,560 mapping from a number of sources. The maps appear unfinished - with all military camps and other strategic sites removed. These maps were initially overprinted with the National Grid. In 1970, the first 1:10,000 maps were produced using the Transverse Mercator Projection. The revision process continued until recently, with new editions appearing every 10 years or so for urban areas.

Map Name(s) and Date(s)

050SE 1947 1:10,560	051SW 1947 1:10,560
059NE 1947 1:10,560	060NW 1947 1:10,560

Historical Map - Slice E

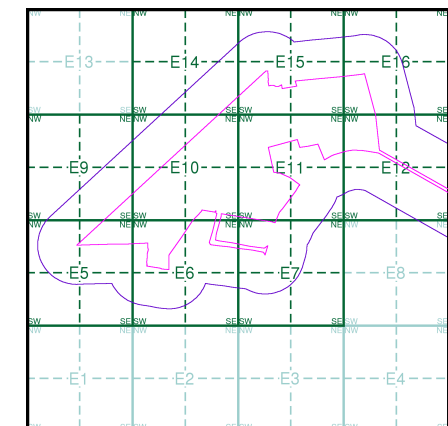

Order Details

Order Number: 298001007_1_1
 Customer Ref: 21-1098.04
 National Grid Reference: 483820, 381060
 Slice: E
 Site Area (Ha): 471.82
 Search Buffer (m): 250

Site Details

West Barton 1

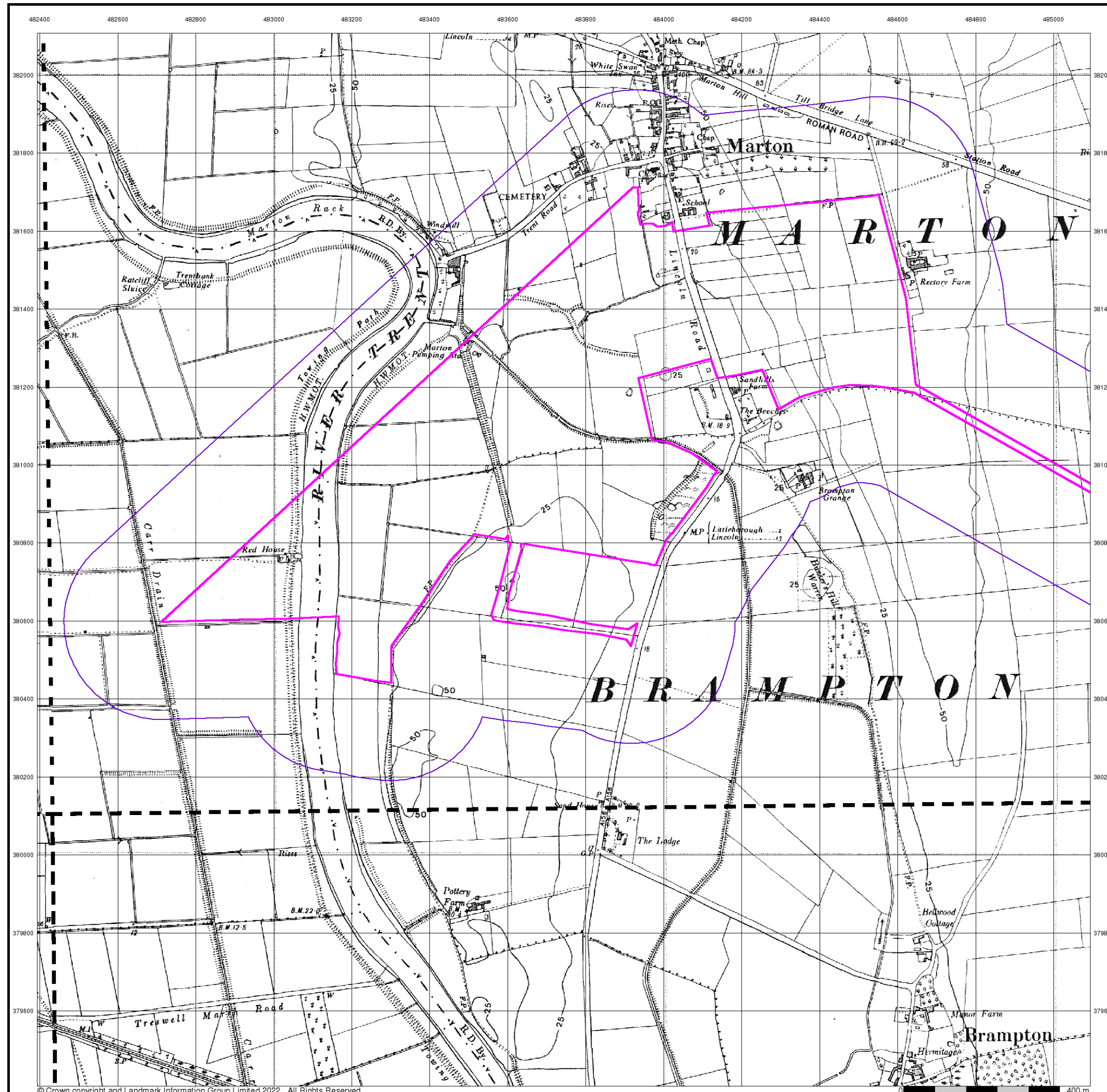

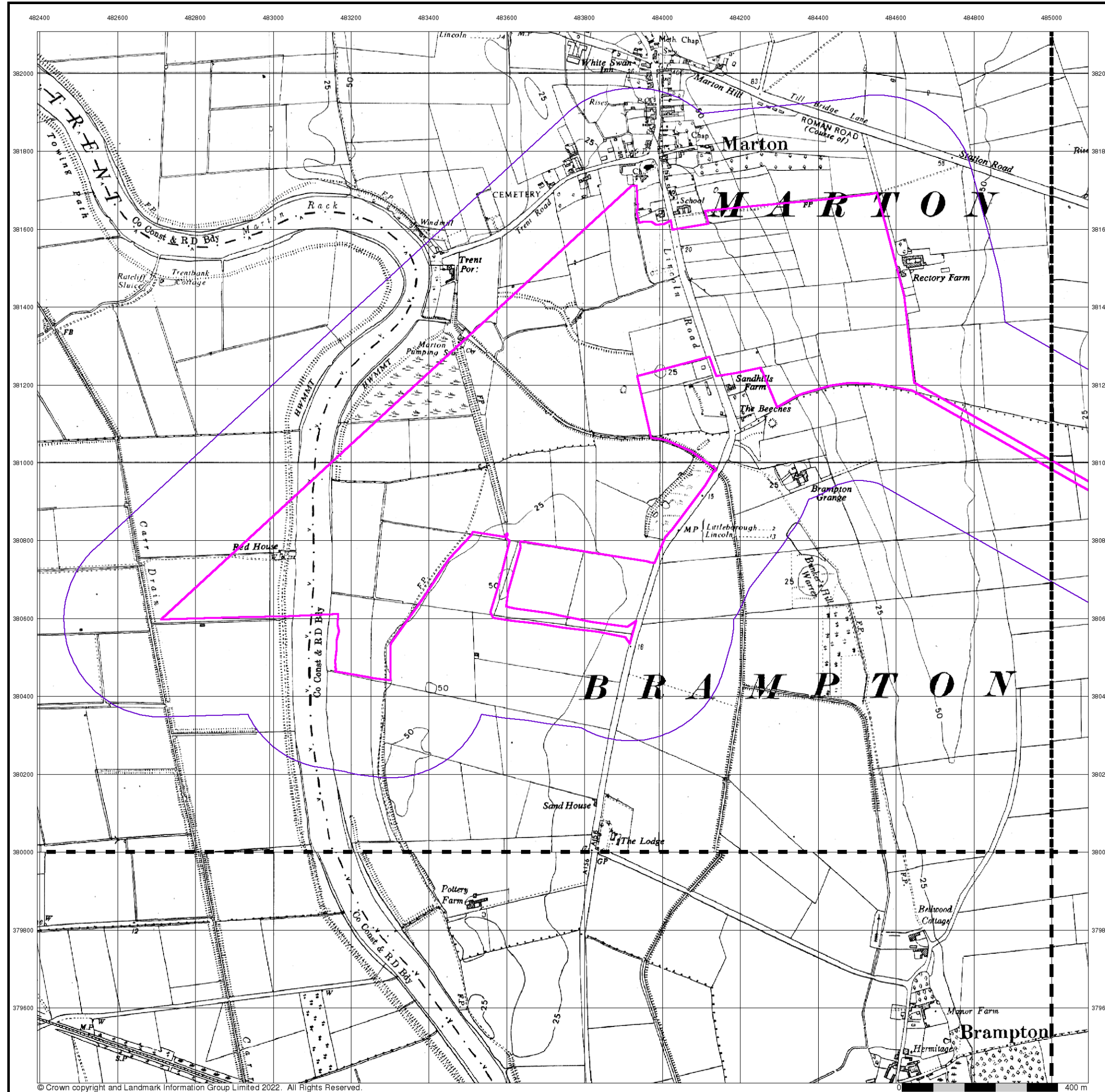

© Crown copyright and Landmark Information Group Limited 2022. All Rights Reserved.



Ordnance Survey Plan
Published 1956
Source map scale - 1:10,000

The historical maps shown were reproduced from maps predominantly held at the scale adopted for England, Wales and Scotland in the 1840's. In 1854 the 1:2,500 scale was adopted for mapping urban areas; these maps were used to update the 1:10,560 maps. The published date given therefore is often some years later than the surveyed date. Before 1938, all OS maps were based on the Cassini Projection, with independent surveys of a single county or group of counties, giving rise to significant inaccuracies in outlying areas. In the late 1940's, a Provisional Edition was produced, which updated the 1:10,560 mapping from a number of sources. The maps appear unfinished - with all military camps and other strategic sites removed. These maps were initially overprinted with the National Grid. In 1970, the first 1:10,000 maps were produced using the Transverse Mercator Projection. The revision process continued until recently, with new editions appearing every 10 years or so for urban areas.

Map Name(s) and Date(s)

SK88SW 1956 1:10,560	SK88SE 1956 1:10,560
SK87NW 1956 1:10,560	SK87NE 1956 1:10,560

Historical Map - Slice E

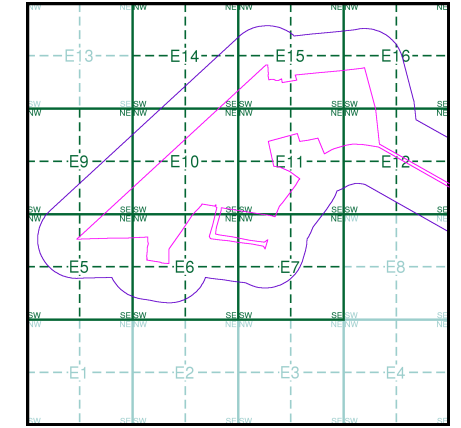

Order Details

Order Number: 298001007_1_1
 Customer Ref: 21-1098.04
 National Grid Reference: 483820, 381060
 Slice: E
 Site Area (Ha): 471.82
 Search Buffer (m): 250

Site Details

West Barton 1



Tel: 0844 844 9952
 Fax: 0844 844 9951
 Web: [REDACTED]

Ordnance Survey Plan

Published 1974 - 1979

Source map scale - 1:10,000

The historical maps shown were reproduced from maps predominantly held at the scale adopted for England, Wales and Scotland in the 1840's. In 1854 the 1:2,500 scale was adopted for mapping urban areas; these maps were used to update the 1:10,560 maps. The published date given therefore is often some years later than the surveyed date. Before 1938, all OS maps were based on the Cassini Projection, with independent surveys of a single county or group of counties, giving rise to significant inaccuracies in outlying areas. In the late 1940's, a Provisional Edition was produced, which updated the 1:10,560 mapping from a number of sources. The maps appear unfinished - with all military camps and other strategic sites removed. These maps were initially overprinted with the National Grid. In 1970, the first 1:10,000 maps were produced using the Transverse Mercator Projection. The revision process continued until recently, with new editions appearing every 10 years or so for urban areas.

Map Name(s) and Date(s)

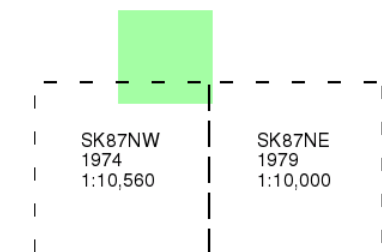

Historical Map - Slice E

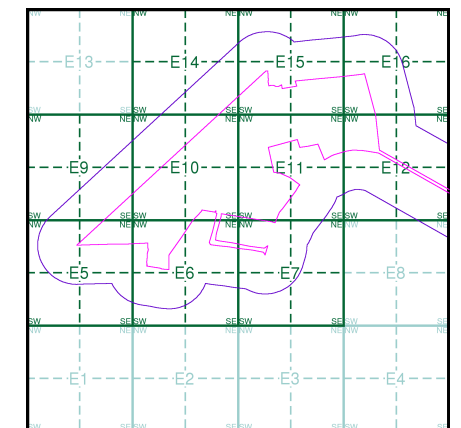

Order Details

Order Number: 298001007_1_1
 Customer Ref: 21-1098.04
 National Grid Reference: 483820, 381060
 Slice: E
 Site Area (Ha): 471.82
 Search Buffer (m): 250

Site Details

West Barton 1

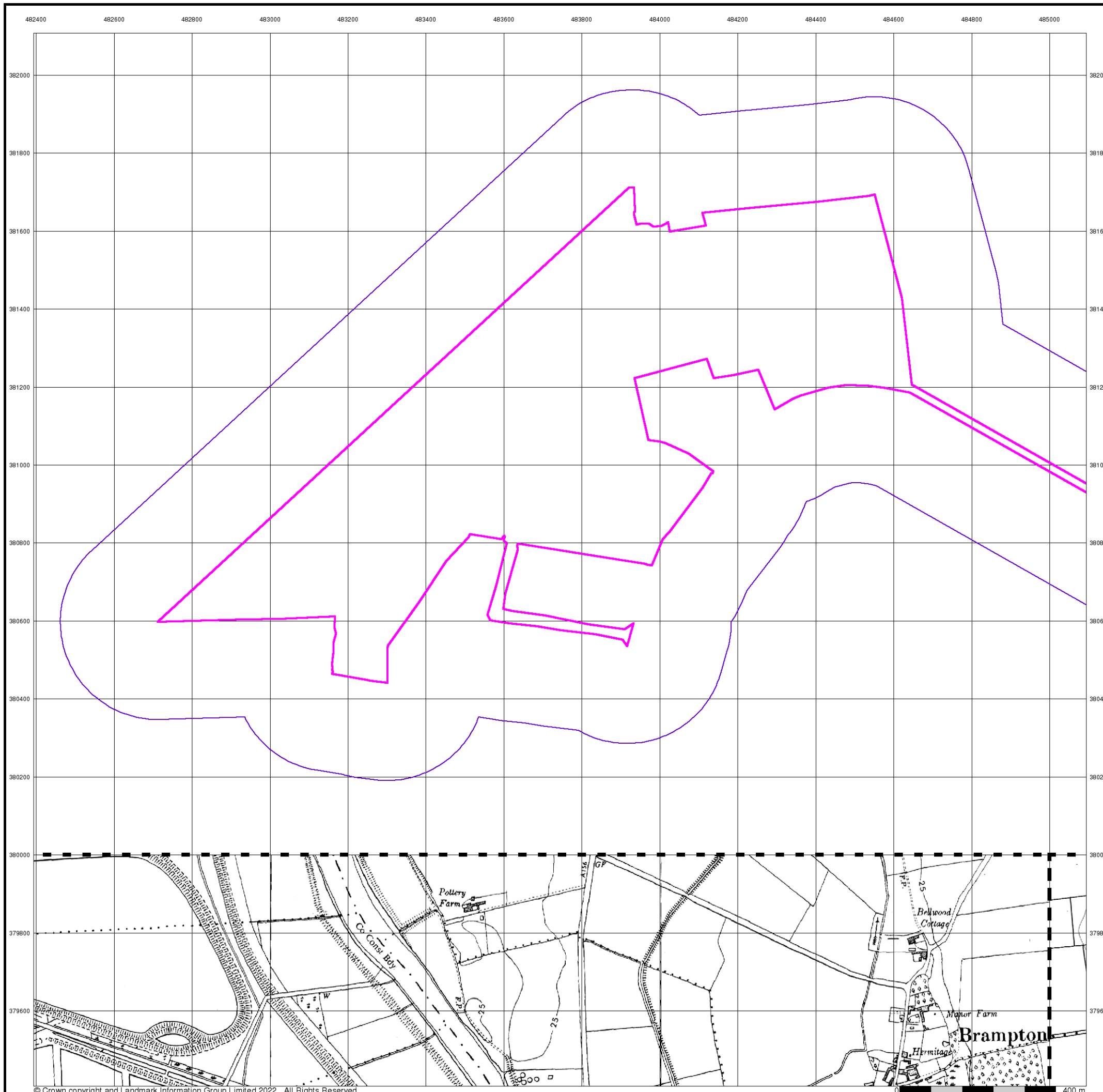

Ordnance Survey Plan
Published 1980 - 1981
Source map scale - 1:10,000

The historical maps shown were reproduced from maps predominantly held at the scale adopted for England, Wales and Scotland in the 1840's. In 1854 the 1:2,500 scale was adopted for mapping urban areas; these maps were used to update the 1:10,560 maps. The published date given therefore is often some years later than the surveyed date. Before 1938, all OS maps were based on the Cassini Projection, with independent surveys of a single county or group of counties, giving rise to significant inaccuracies in outlying areas. In the late 1940's, a Provisional Edition was produced, which updated the 1:10,560 mapping from a number of sources. The maps appear unfinished - with all military camps and other strategic sites removed. These maps were initially overprinted with the National Grid. In 1970, the first 1:10,000 maps were produced using the Transverse Mercator Projection. The revision process continued until recently, with new editions appearing every 10 years or so for urban areas.

Map Name(s) and Date(s)

SK88SW 1980 1:10,000	SK88SE 1981 1:10,000
SK87NW 1980 1:10,000	

Historical Map - Slice E

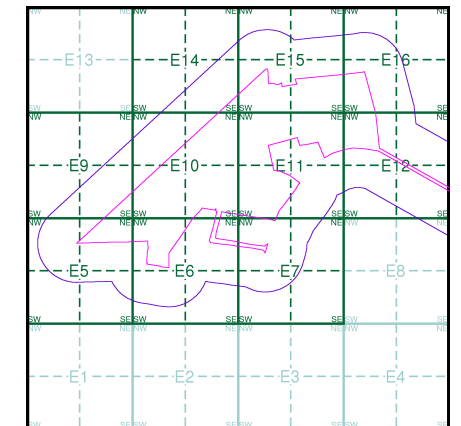

Order Details

Order Number: 298001007_1_1
 Customer Ref: 21-1098.04
 National Grid Reference: 483820, 381060
 Slice: E
 Site Area (Ha): 471.82
 Search Buffer (m): 250

Site Details

West Barton 1

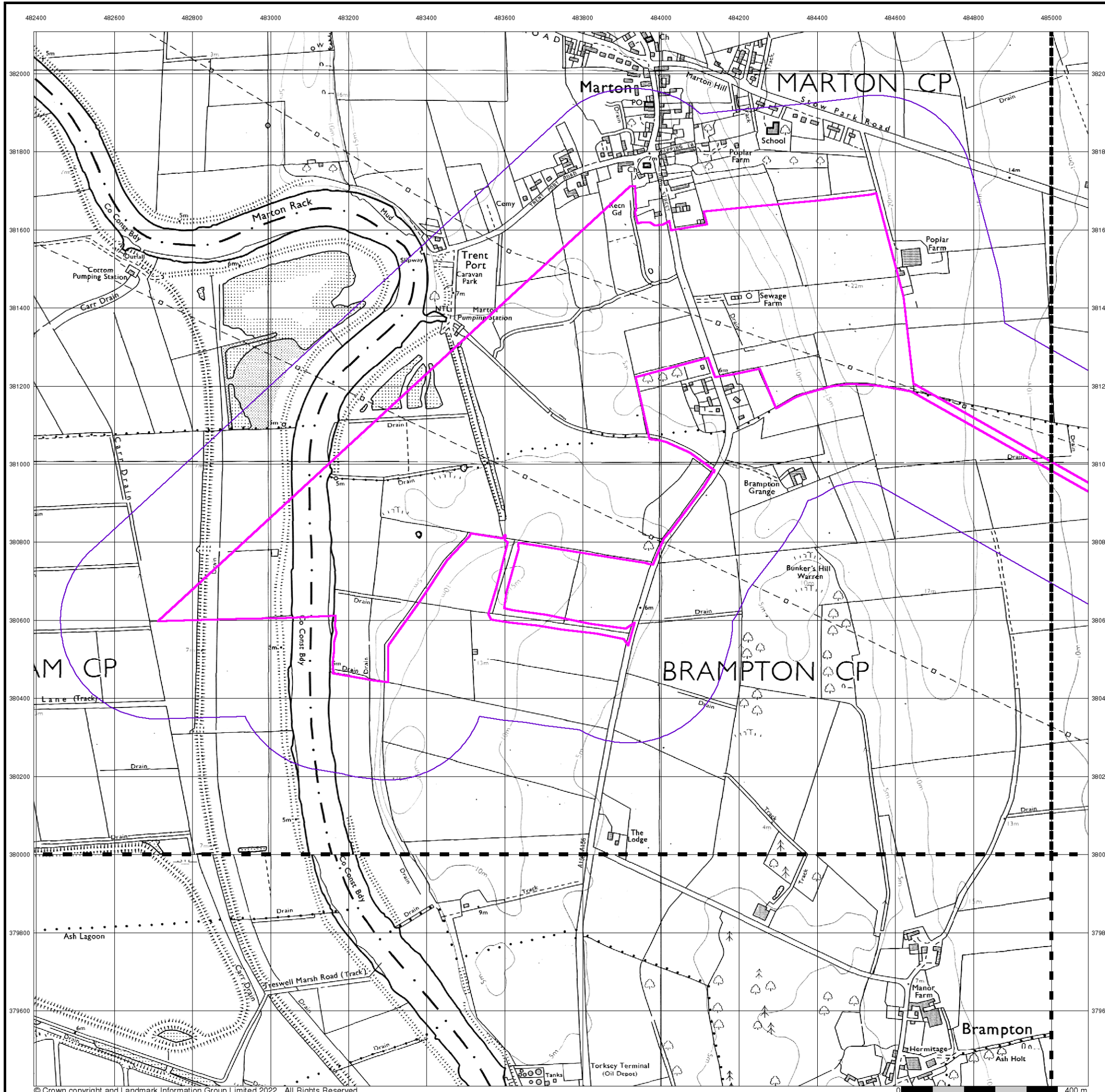

10k Raster Mapping

Published 2000

Source map scale - 1:10,000

The historical maps shown were produced from the Ordnance Survey's 1:10,000 colour raster mapping. These maps are derived from Landplan which replaced the old 1:10,000 maps originally published in 1970. The data is highly detailed showing buildings, fences and field boundaries as well as all roads, tracks and paths. Road names are also included together with the relevant road number and classification. Boundary information depiction includes county, unitary authority, district, civil parish and constituency.

Map Name(s) and Date(s)

SK88SW 2000 1:10,000	SK88SE 2000 1:10,000
SK87NW 2000 1:10,000	SK87NE 2000 1:10,000

Historical Map - Slice E

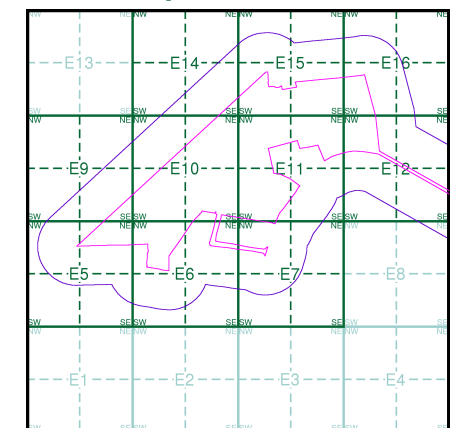

Order Details

Order Number: 298001007_1_1
 Customer Ref: 21-1098.04
 National Grid Reference: 483820, 381060
 Slice: E
 Site Area (Ha): 471.82
 Search Buffer (m): 250

Site Details

West Barton 1

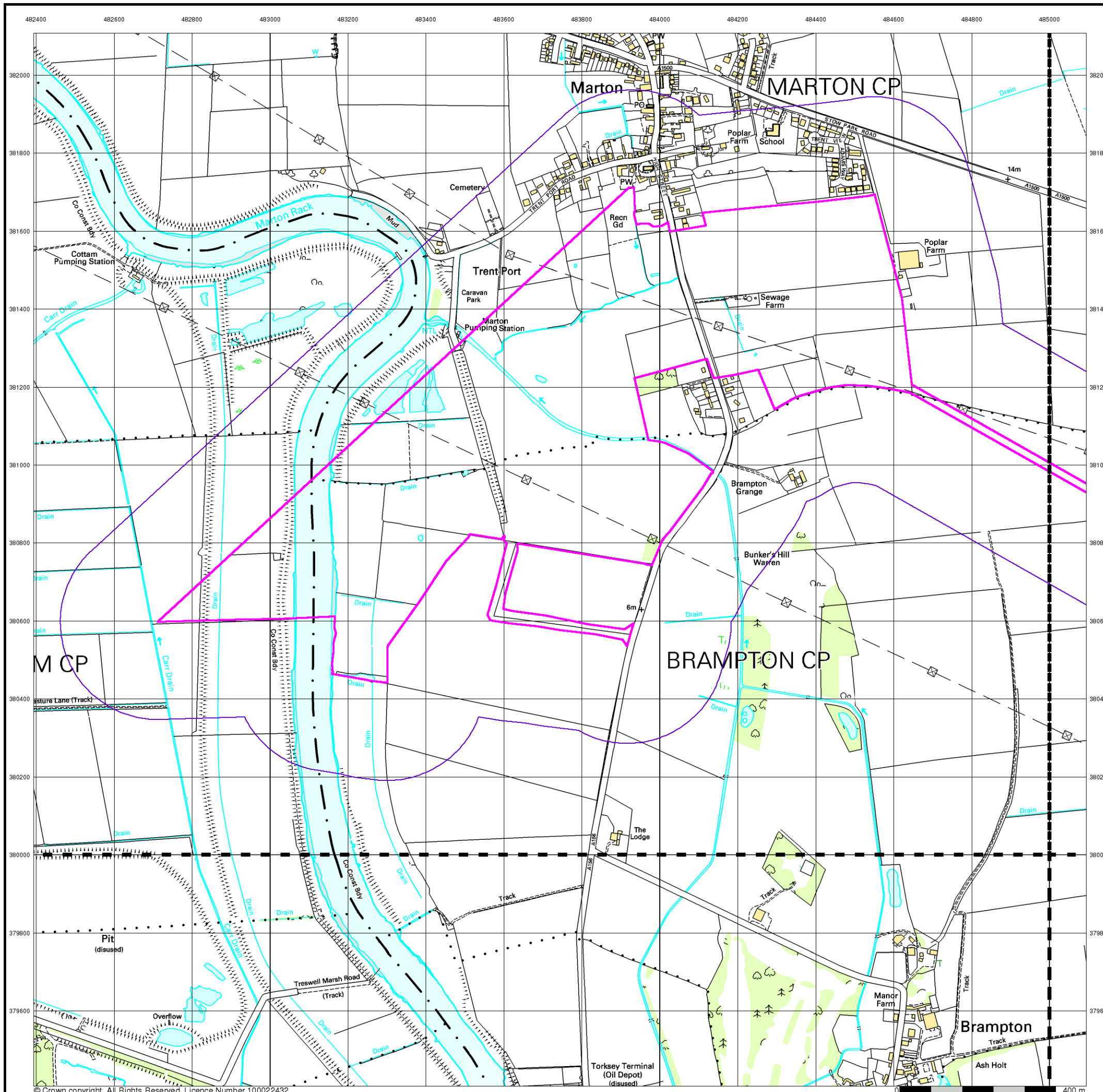

© Crown copyright. All Rights Reserved. Licence Number 100022432.

Street View

Published 2022

Source map scale - 1:10,000

Street View is a street-level map for the whole of Great Britain produced by the Ordnance Survey. These maps are provided at a nominal scale of 1:10,000

Map Name(s) and Date(s)



Street View Map - Slice E

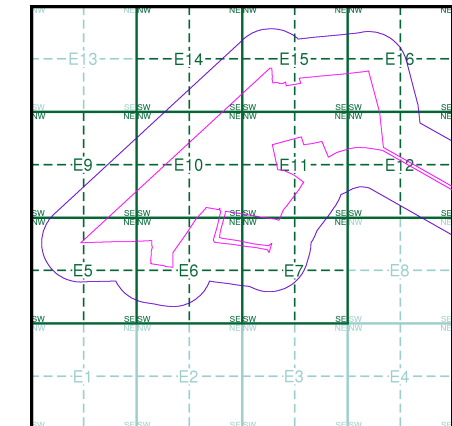

Order Details

Order Number: 298001007_1_1
 Customer Ref: 21-1098.04
 National Grid Reference: 483820, 381060
 Slice: E
 Site Area (Ha): 471.82
 Search Buffer (m): 250

Site Details

West Barton 1

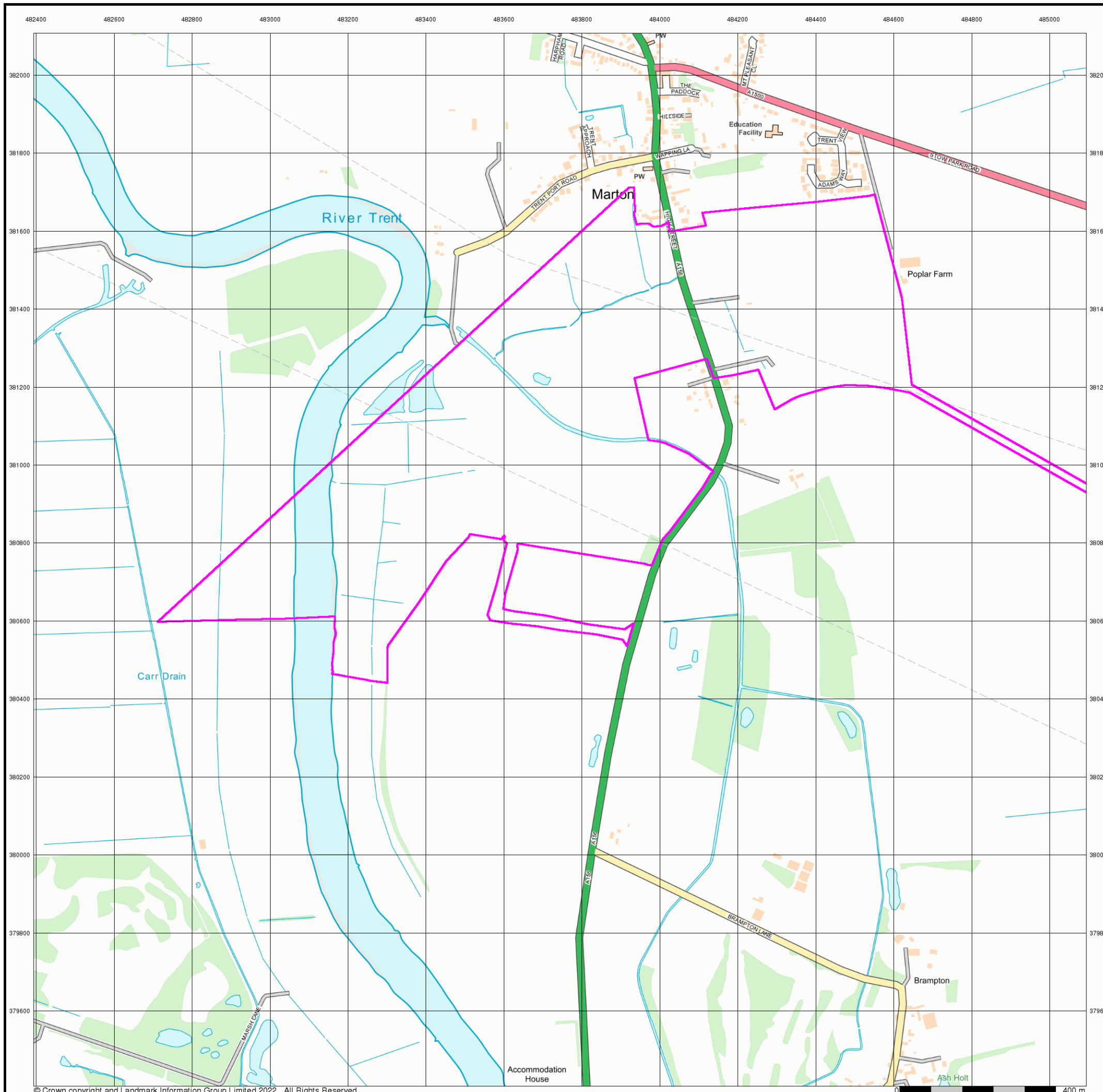

Historical Mapping Legends

Ordnance Survey County Series and Ordnance Survey Plan 1:2,500

Quarry **Gravel Pit** **Sand Pit**
Clay Pit **Shingle** **Refuse Heap**
Sloping Masonry **Flat Rock**
Marsh **Reeds** **Osiers**
Rough Pasture **Furze** **Wood**
Mixed Wood **Brushwood** **Orchard**
Fir **Ford** **Stepping Stones**
Ferry **Waterfall** **Lock**
Trig. Station **Altitude at Trig. Station**
B.M. 325.9 **Bench Mark** **Surface Level**
Arrow denotes flow of water **Antiquities (site of)**
Cutting **Embankment**
Railway crossing Road **Level Crossing** **Road crossing Railway**
Railway crossing River or Canal **Road over single stream** **Road over River or Canal**
County Boundary (Geographical)
County & Civil Parish Boundary
Administrative County & Civil Parish Boundary
County Borough Boundary (England)
County Burgh Boundary (Scotland)
Boundary Post or Stone **Police Call Box**
B.R. Bridle Road **Pump**
E.P. Electricity Pylon **S.P. Signal Post**
F.B. Foot Bridge **Sl. Sluice**
F.P. Foot Path **Sp. Spring**
G.P. Guide Post or Board **T.C.B. Telephone Call Box**
M.S. Mile Stone **Tr. Trough**
M.P. M.R. Mooring Post or Ring **W. Well**

Ordnance Survey Plan, Additional SIMs and Supply of Unpublished Survey Information 1:2,500 and 1:1,250

Inactive Quarry, Chalk Pit or Clay Pit **Active Quarry, Chalk Pit or Clay Pit**
Rock **Boulders**
Cliff **Slopes** **Top**
Roofed Building **Glazed Roof Building**
Sloping Masonry **Archway**
Non-Coniferous Tree (surveyed) **Coniferous Tree (surveyed)**
Non-Coniferous Trees (not surveyed) **Coniferous Trees (not surveyed)**
Orchard Tree **Scrub** **Bracken**
Coppice, Osier **Reeds** **Marsh, Saltings**
Rough Grassland **Heath** **Culvert**
Direction of water flow **Bench Mark** **Antiquity (site of)**
Cave Entrance **Triangulation Station** **Electricity Pylon**
Electricity Transmission Line
County Boundary (Geographical)
County & Civil Parish Boundary
Civil Parish Boundary
Admin. County or County Bor. Boundary
London Borough Boundary
Symbol marking point where boundary mereing changes
Beer House **Pillar, Pole or Post**
Boundary Post or Stone **Post Office**
Capstan, Crane **Public Convenience**
Chimney **Public House**
Drinking Fountain **Pump**
Electricity Pillar or Post **Signal Box or Bridge**
Fire Alarm Pillar **Signal Post or Light**
Foot Bridge **Spring**
Guide Post **Tank or Track**
Hydrant or Hydraulic **Telephone Call Box**
Level Crossing **Telephone Call Post**
Manhole **Trough**
Mile Post or Mooring Post **Water Point, Water Tap**
Mile Stone **Well**
Normal Tidal Limit **Wind Pump**

Large-Scale National Grid Data 1:2,500 and 1:1,250

Cliff **Slopes** **Top**
Rock **Rock (scattered)**
Boulders **Boulders (scattered)**
Positioned Boulder **Scree**
Non-Coniferous Tree (surveyed) **Coniferous Tree (surveyed)**
Non-Coniferous Trees (not surveyed) **Coniferous Trees (not surveyed)**
Orchard Tree **Scrub** **Bracken**
Coppice, Osier **Reeds** **Marsh, Saltings**
Rough Grassland **Heath** **Culvert**
Direction of water flow **Triangulation Station** **Antiquity (site of)**
Electricity Transmission Line **Electricity Pylon**
Bench Mark **Buildings with Building Seed**
Roofed Building **Glazed Roof Building**
Civil parish/community boundary
District boundary
County boundary
Boundary post/stone
Boundary mereing symbol (note: these always appear in opposed pairs or groups of three)
Barracks **Pillar, Pole or Post**
Battery **Post Office**
Cemetery **Public Convenience**
Chimney **Pump**
Cistern **Pumping Station**
Dismtd Rly **Place of Worship**
Electricity Generating Station **Sewage Ppg Sta** **Sewage Pumping Station**
Electricity Pole, Pillar **Signal Box or Bridge**
Electricity Sub Station **Signal Post or Light**
Filter Bed **Spring**
Fountain / Drinking Ftn. **Tank or Track**
Gas Valve Compound **Trough**
Gas Governor **Wind Pump**
Guide Post **Water Point, Water Tap**
Manhole **Works (building or area)**
Mile Post or Mile Stone **Well**



Historical Mapping & Photography included:

Mapping Type	Scale	Date	Pg
Lincolnshire	1:2,500	1885 - 1886	2
Nottinghamshire	1:2,500	1885 - 1886	3
Nottinghamshire	1:2,500	1899 - 1900	4
Nottinghamshire	1:2,500	1920	5
Lincolnshire	1:2,500	1920	6
Ordnance Survey Plan	1:2,500	1974	7
Large-Scale National Grid Data	1:2,500	1994	8

Historical Map - Segment E5

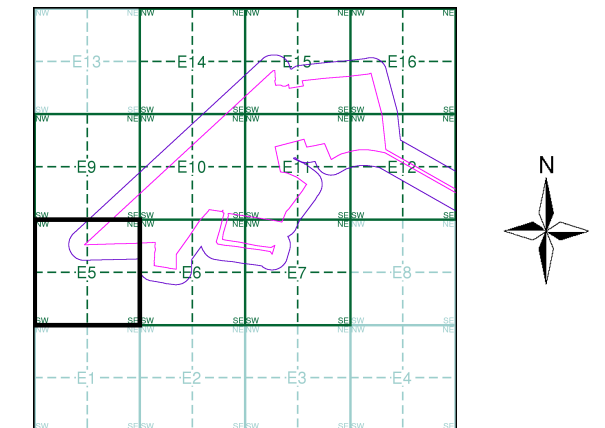

Order Details

Order Number: 298001007_1_1
 Customer Ref: 21-1098.04
 National Grid Reference: 483820, 381060
 Slice: E
 Site Area (Ha): 471.82
 Search Buffer (m): 100

Site Details

West Barton 1



Tel: 0844 844 9952
 Fax: 0844 844 9951
 Web: [REDACTED]

482400

482600

482800

483000



Lincolnshire

Published 1885 - 1886

Source map scale - 1:2,500

The historical maps shown were reproduced from maps predominantly held at the scale adopted for England, Wales and Scotland in the 1840's. In 1854 the 1:2,500 scale was adopted for mapping urban areas and by 1896 it covered the whole of what were considered to be the cultivated parts of Great Britain. The published date given below is often some years later than the surveyed date. Before 1938, all OS maps were based on the Cassini Projection, with independent surveys of a single county or group of counties, giving rise to significant inaccuracies in outlying areas.

Map Name(s) and Date(s)

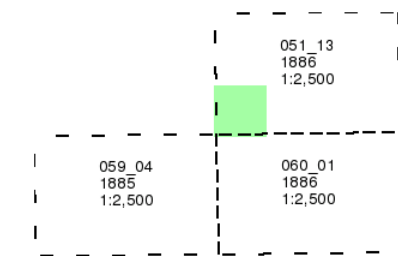

Historical Map - Segment E5

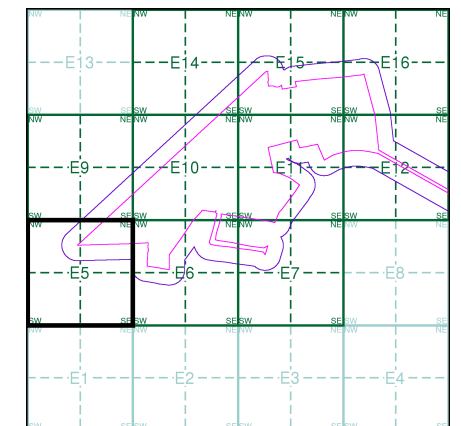

Order Details

Order Number: 298001007_1_1
Customer Ref: 21-1098.04
National Grid Reference: 483820, 381060
Slice: E
Site Area (Ha): 471.82
Search Buffer (m): 100

Site Details

West Barton 1



Tel: 0844 844 9952
Fax: 0844 844 9951
Web: [REDACTED]

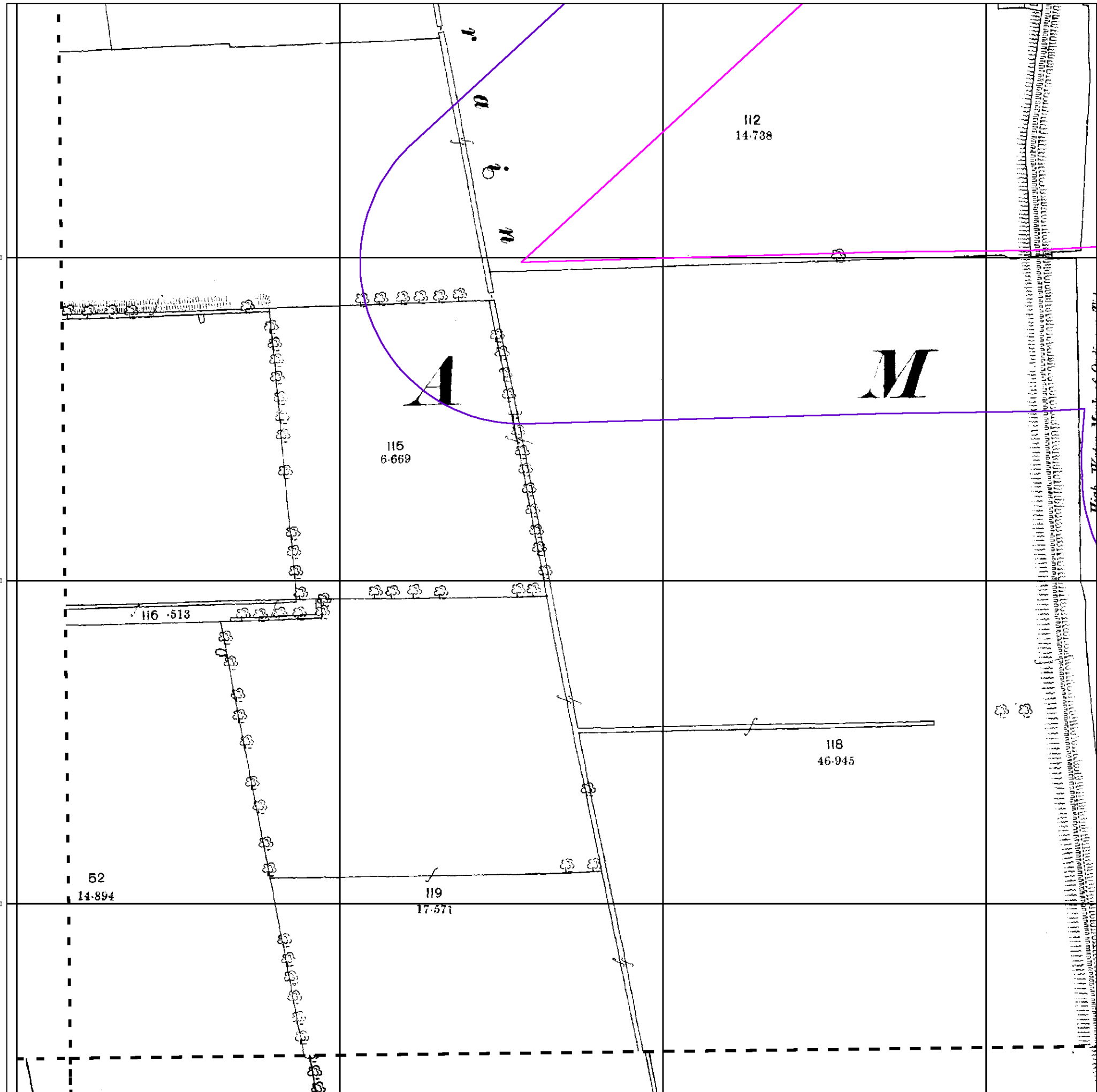

Nottinghamshire

Published 1885 - 1886

Source map scale - 1:2,500

The historical maps shown were reproduced from maps predominantly held at the scale adopted for England, Wales and Scotland in the 1840's. In 1854 the 1:2,500 scale was adopted for mapping urban areas and by 1896 it covered the whole of what were considered to be the cultivated parts of Great Britain. The published date given below is often some years later than the surveyed date. Before 1938, all OS maps were based on the Cassini Projection, with independent surveys of a single county or group of counties, giving rise to significant inaccuracies in outlying areas.

Map Name(s) and Date(s)

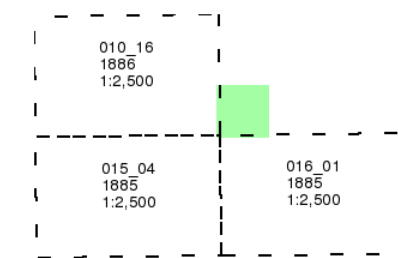

Historical Map - Segment E5

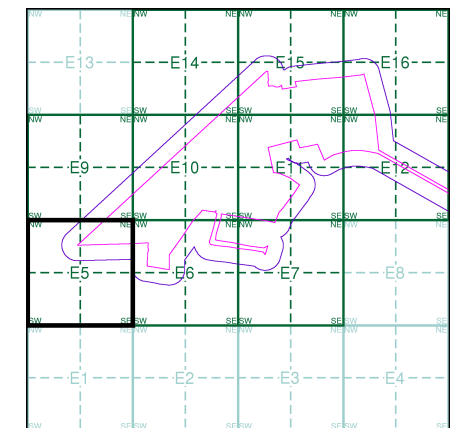

Order Details

Order Number: 298001007_1_1
 Customer Ref: 21-1098.04
 National Grid Reference: 483820, 381060
 Slice: E
 Site Area (Ha): 471.82
 Search Buffer (m): 100

Site Details

West Barton 1

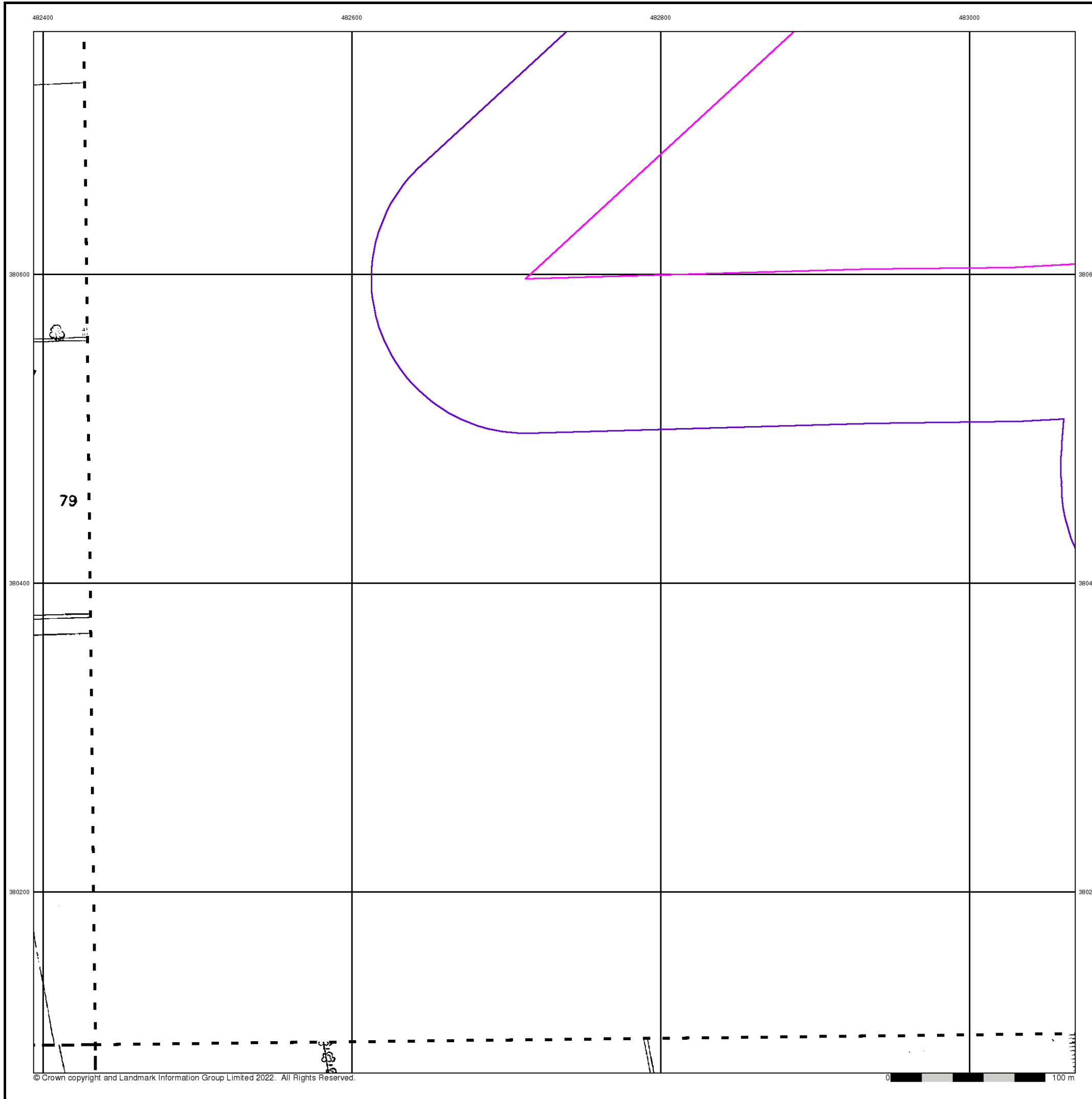

482400

482600

482800

483000



Nottinghamshire

Published 1899 - 1900

Source map scale - 1:2,500

The historical maps shown were reproduced from maps predominantly held at the scale adopted for England, Wales and Scotland in the 1840's. In 1854 the 1:2,500 scale was adopted for mapping urban areas and by 1896 it covered the whole of what were considered to be the cultivated parts of Great Britain. The published date given below is often some years later than the surveyed date. Before 1938, all OS maps were based on the Cassini Projection, with independent surveys of a single county or group of counties, giving rise to significant inaccuracies in outlying areas.

Map Name(s) and Date(s)

010_16 1899 1:2,500	011_13 1899 1:2,500
015_04 1900 1:2,500	016_01 1899 1:2,500

Historical Map - Segment E5

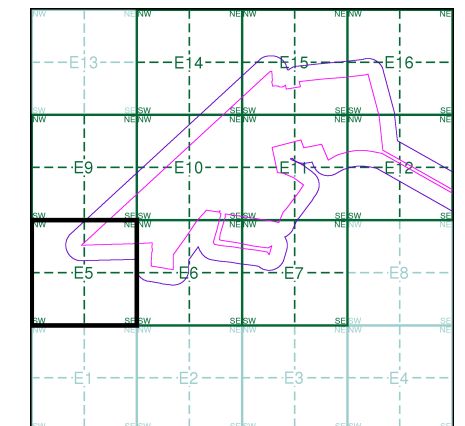

Order Details

Order Number: 298001007_1_1
 Customer Ref: 21-1098.04
 National Grid Reference: 483820, 381060
 Slice: E
 Site Area (Ha): 471.82
 Search Buffer (m): 100

Site Details

West Barton 1



Tel: 0844 844 9952
 Fax: 0844 844 9951
 Web: [REDACTED]

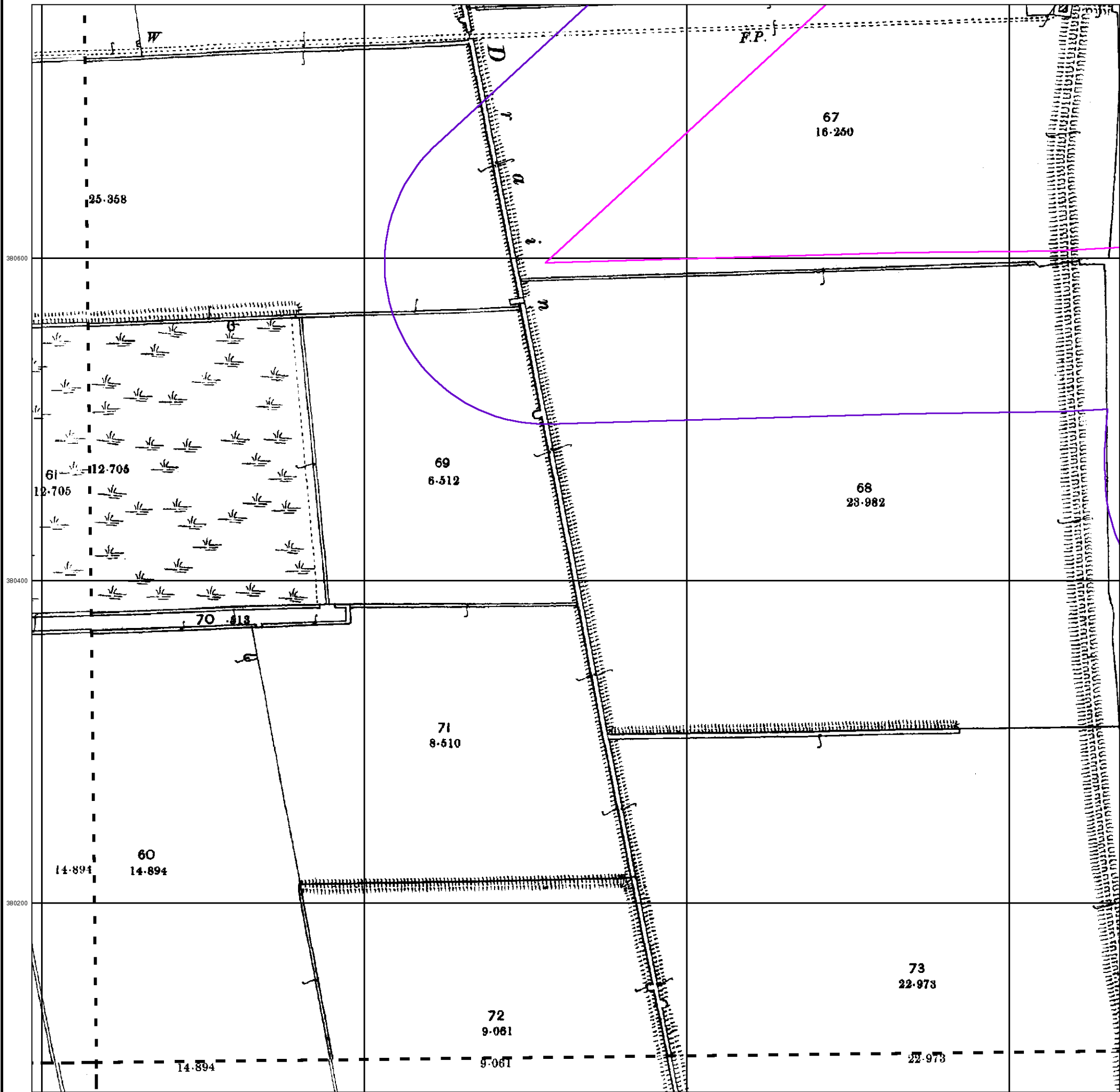

482400

482600

482800

483000

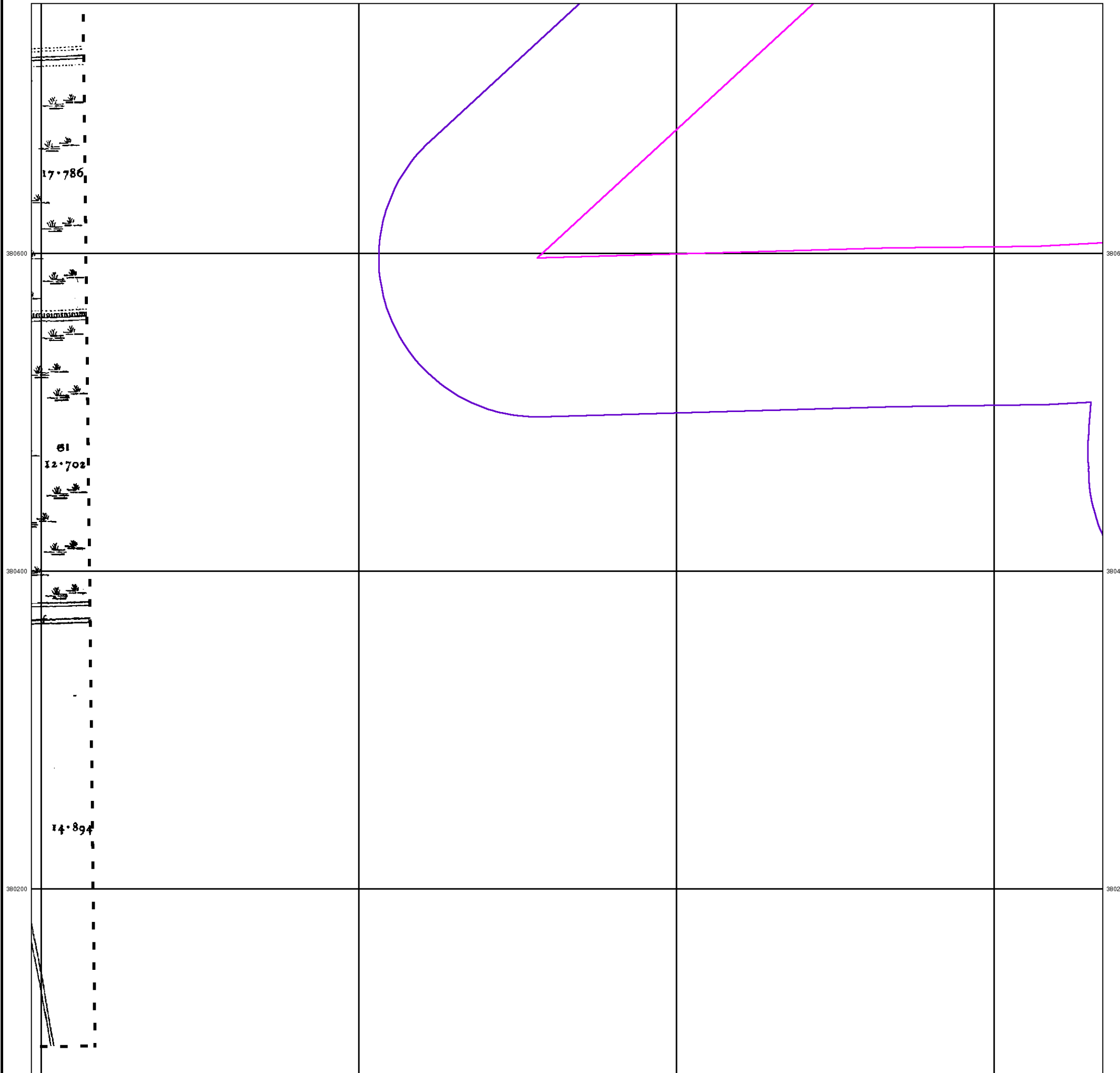

© Crown copyright and Landmark Information Group Limited 2022. All Rights Reserved.

0 100 m



Nottinghamshire

Published 1920

Source map scale - 1:2,500

The historical maps shown were reproduced from maps predominantly held at the scale adopted for England, Wales and Scotland in the 1840's. In 1854 the 1:2,500 scale was adopted for mapping urban areas and by 1896 it covered the whole of what were considered to be the cultivated parts of Great Britain. The published date given below is often some years later than the surveyed date. Before 1938, all OS maps were based on the Cassini Projection, with independent surveys of a single county or group of counties, giving rise to significant inaccuracies in outlying areas.

Map Name(s) and Date(s)

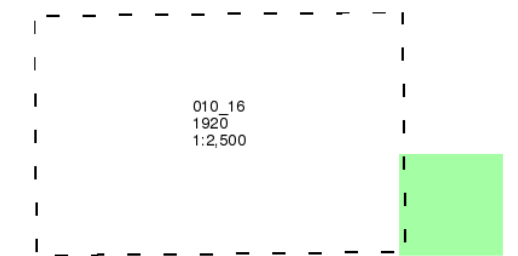

Historical Map - Segment E5

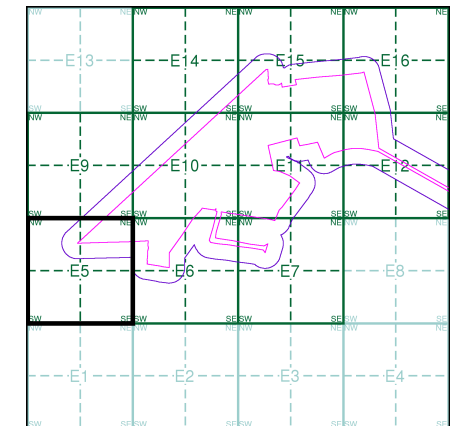

Order Details

Order Number: 298001007_1_1
 Customer Ref: 21-1098.04
 National Grid Reference: 483820, 381060
 Slice: E
 Site Area (Ha): 471.82
 Search Buffer (m): 100

Site Details

West Barton 1



Tel: 0844 844 9952
 Fax: 0844 844 9951
 Web: [REDACTED]

482400

482600

482800

483000



Lincolnshire

Published 1920

Source map scale - 1:2,500

The historical maps shown were reproduced from maps predominantly held at the scale adopted for England, Wales and Scotland in the 1840's. In 1854 the 1:2,500 scale was adopted for mapping urban areas and by 1896 it covered the whole of what were considered to be the cultivated parts of Great Britain. The published date given below is often some years later than the surveyed date. Before 1938, all OS maps were based on the Cassini Projection, with independent surveys of a single county or group of counties, giving rise to significant inaccuracies in outlying areas.

Map Name(s) and Date(s)

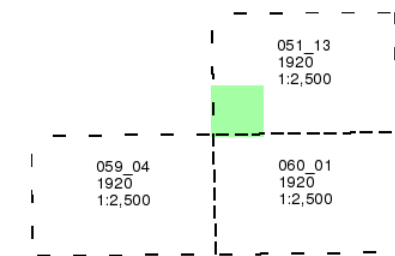

Historical Map - Segment E5

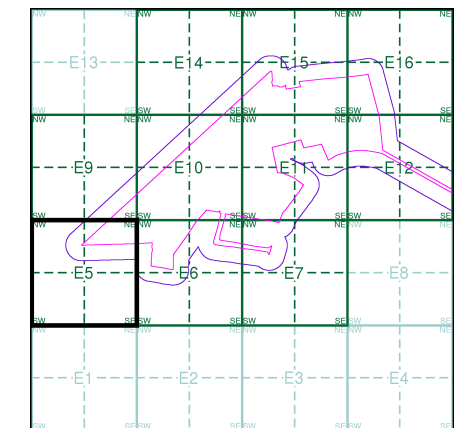

Order Details

Order Number: 298001007_1_1
Customer Ref: 21-1098.04
National Grid Reference: 483820, 381060
Slice: E
Site Area (Ha): 471.82
Search Buffer (m): 100

Site Details

West Barton 1



Tel: 0844 844 9952
Fax: 0844 844 9951
Web: [REDACTED]

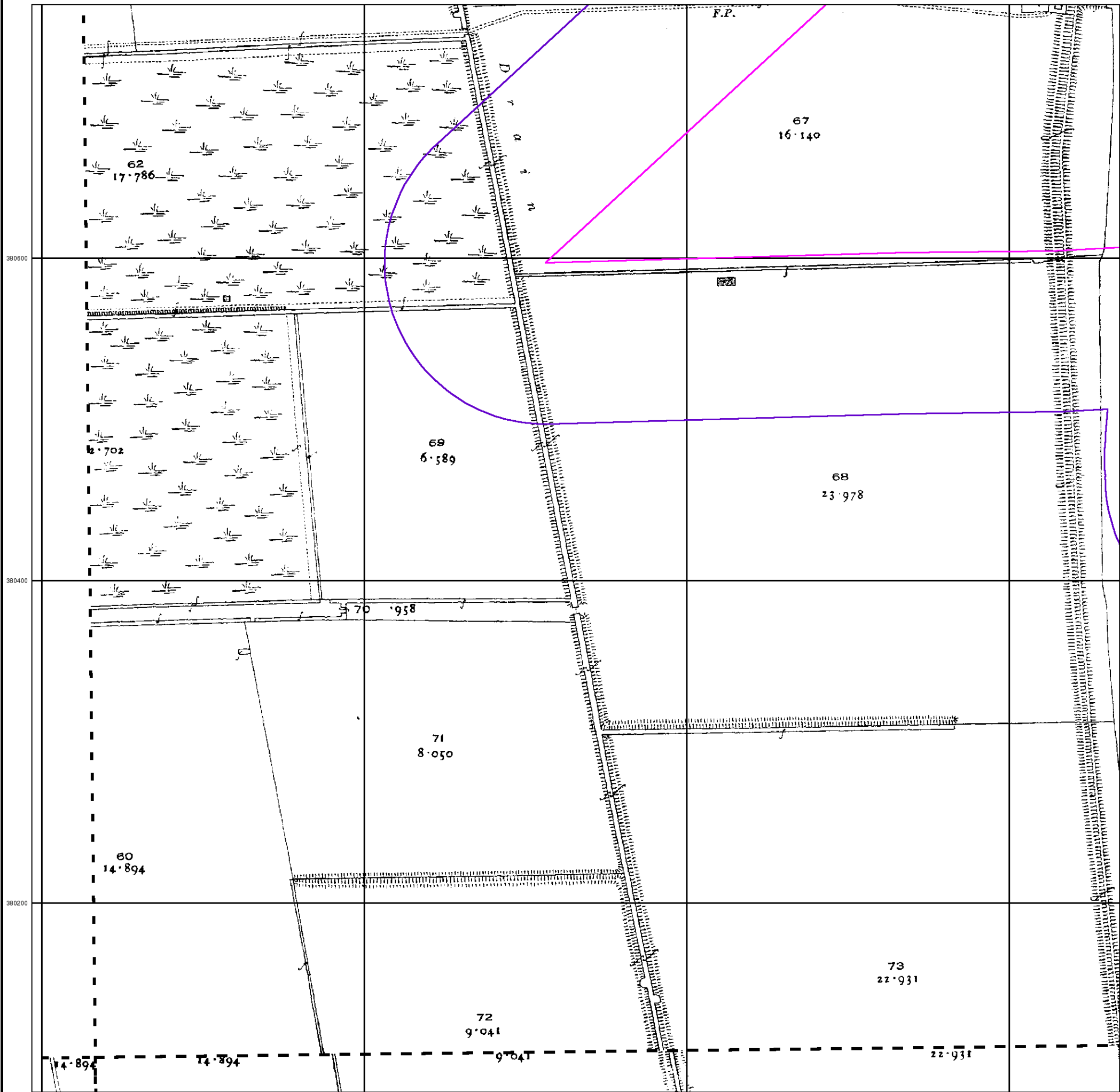

Ordnance Survey Plan

Published 1974

Source map scale - 1:2,500

The historical maps shown were reproduced from maps predominantly held at the scale adopted for England, Wales and Scotland in the 1840's. In 1854 the 1:2,500 scale was adopted for mapping urban areas and by 1896 it covered the whole of what were considered to be the cultivated parts of Great Britain. The published date given below is often some years later than the surveyed date. Before 1938, all OS maps were based on the Cassini Projection, with independent surveys of a single county or group of counties, giving rise to significant inaccuracies in outlying areas.

Map Name(s) and Date(s)

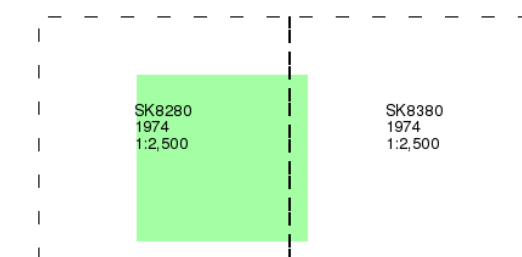

Historical Map - Segment E5

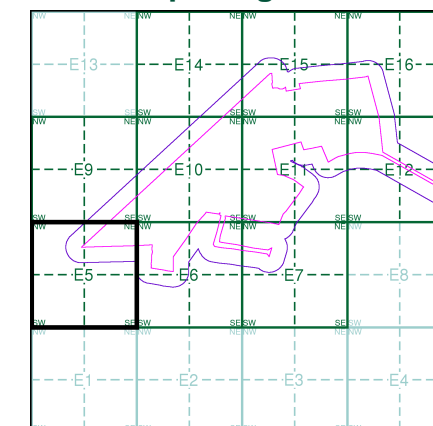

Order Details

Order Number: 298001007_1_1
 Customer Ref: 21-1098.04
 National Grid Reference: 483820, 381060
 Slice: E
 Site Area (Ha): 471.82
 Search Buffer (m): 100

Site Details

West Barton 1

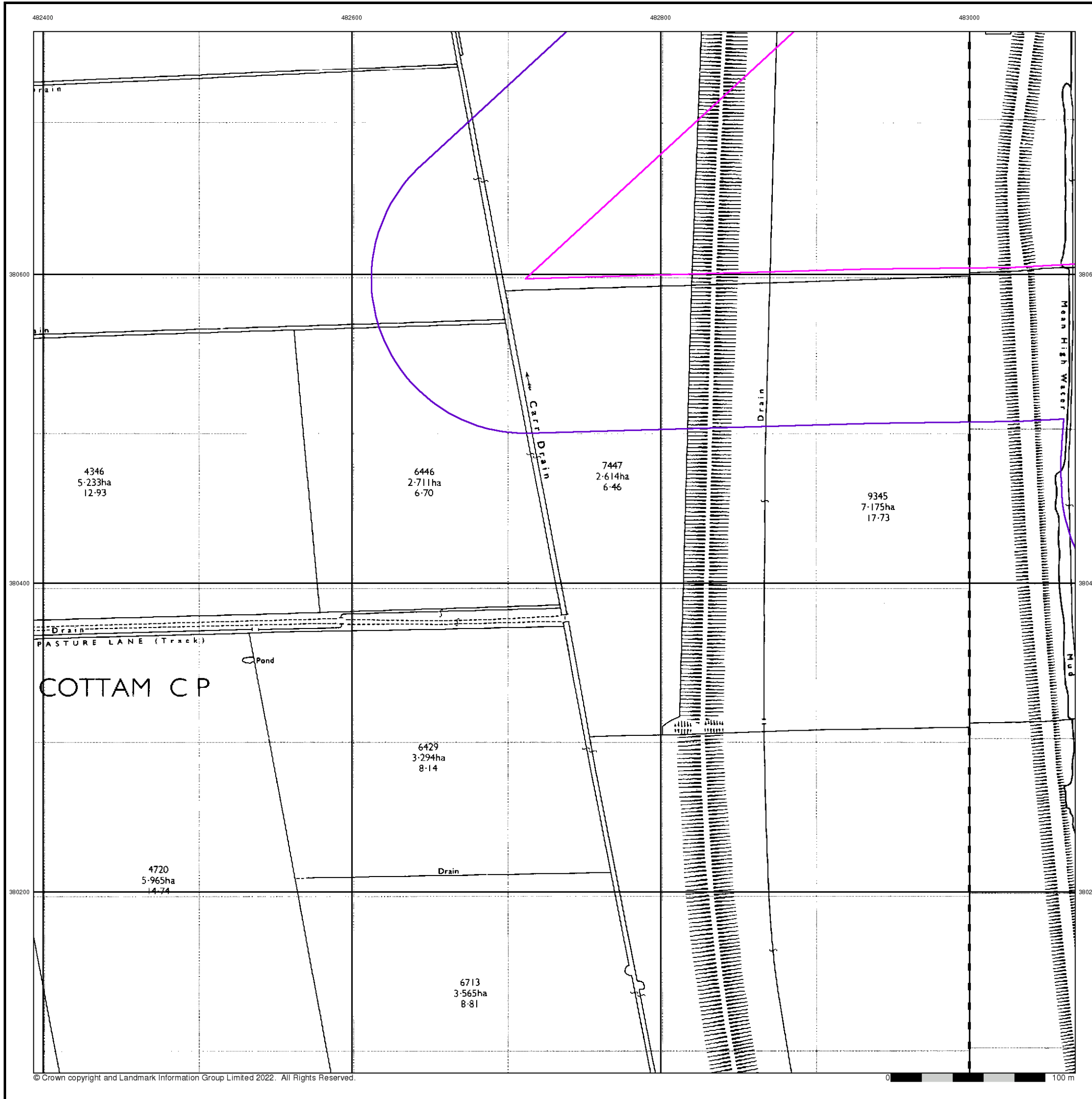

482400

482600

482800

483000

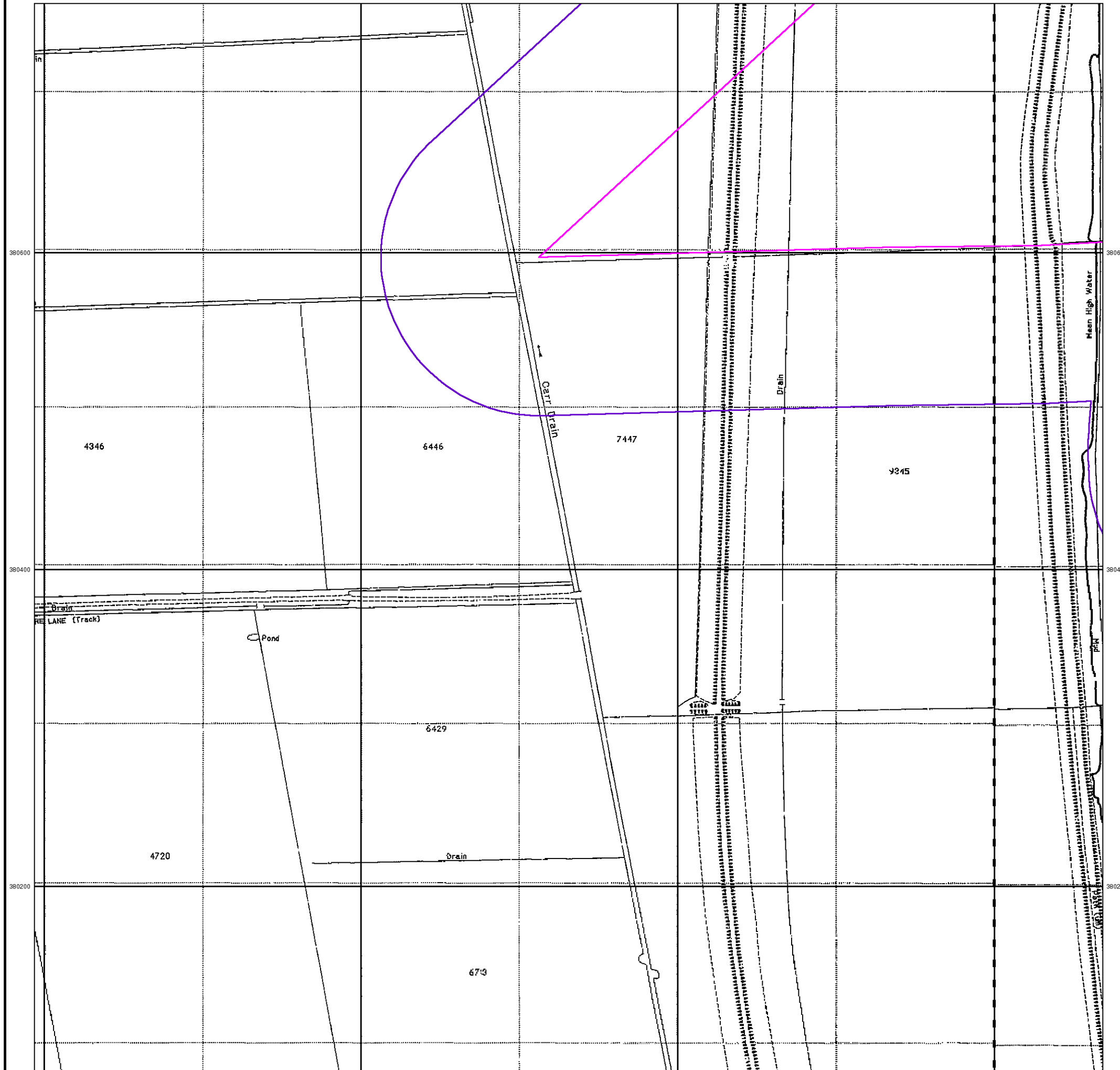

© Crown copyright and Landmark Information Group Limited 2022. All Rights Reserved.

0 100 m



Large-Scale National Grid Data
Published 1994
Source map scale - 1:2,500

'Large Scale National Grid Data' superseded SIM cards (Ordnance Survey's 'Survey of Information on Microfilm') in 1992, and continued to be produced until 1999. These maps were the fore-runners of digital mapping and so provide detailed information on houses and roads, but tend to show less topographic features such as vegetation. These maps were produced at both 1:2,500 and 1:1,250 scales.

Map Name(s) and Date(s)

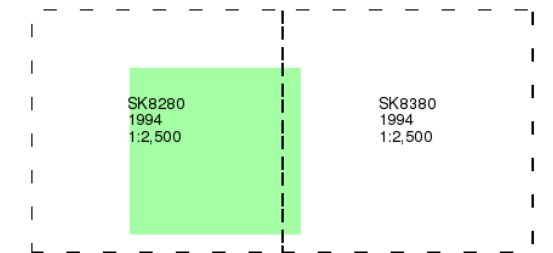

Historical Map - Segment E5

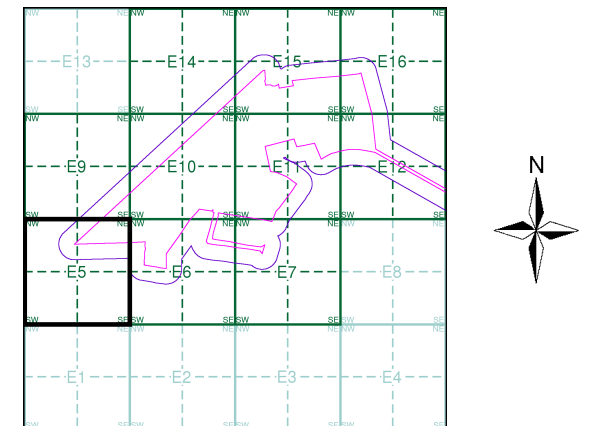

Order Details

Order Number: 298001007_1_1
 Customer Ref: 21-1098.04
 National Grid Reference: 483820, 381060
 Slice: E
 Site Area (Ha): 471.82
 Search Buffer (m): 100

Site Details

West Barton 1



Tel: 0844 844 9952
 Fax: 0844 844 9951
 Web: [REDACTED]

Historical Mapping Legends

Ordnance Survey County Series and Ordnance Survey Plan 1:2,500

Quarry, Gravel Pit, Sand Pit, Clay Pit, Shingle, Refuse Heap, Sloping Masonry, Flat Rock, Marsh, Reeds, Osiers, Rough Pasture, Furze, Wood, Mixed Wood, Brushwood, Orchard, Fir, Ford, Stepping Stones, Ferry, Waterfall, Lock, Trig. Station, Altitude at Trig. Station, Bench Mark, Surface Level, Arrow denotes flow of water, Antiquities (site of), Cutting, Embankment, Railway crossing Road, Level Crossing, Road crossing Railway, Railway crossing River or Canal, Road over single stream, Road over River or Canal

County Boundary (Geographical), County & Civil Parish Boundary, Administrative County & Civil Parish Boundary, County Borough Boundary (England), County Burgh Boundary (Scotland)

<i>B.P.</i> <i>B.S.</i> Boundary Post or Stone	<i>P.C.B.</i> Police Call Box
<i>B.R.</i> Bridle Road	<i>P</i> Pump
<i>E.P.</i> Electricity Pylon	<i>S.P.</i> Signal Post
<i>F.B.</i> Foot Bridge	<i>Sl</i> Sluice
<i>F.P.</i> Foot Path	<i>Sp.</i> Spring
<i>G.P.</i> Guide Post or Board	<i>T.C.B.</i> Telephone Call Box
<i>M.S.</i> Mile Stone	<i>Tr.</i> Trough
<i>M.P.</i> <i>M.R.</i> Mooring Post or Ring	<i>W</i> Well

Ordnance Survey Plan, Additional SIMs and Supply of Unpublished Survey Information 1:2,500 and 1:1,250

Inactive Quarry, Chalk Pit or Clay Pit, Active Quarry, Chalk Pit or Clay Pit, Rock, Boulders, Roofed Building, Glazed Roof Building, Sloping Masonry, Archway, Non-Coniferous Tree (surveyed), Coniferous Tree (surveyed), Non-Coniferous Trees (not surveyed), Coniferous Trees (not surveyed), Orchard Tree, Scrub, Bracken, Coppice, Osier, Reeds, Marsh, Saltings, Rough Grassland, Heath, Culvert, Direction of water flow, Bench Mark, Antiquity (site of), Cave Entrance, Triangulation Station, Electricity Pylon

Electricity Transmission Line

County Boundary (Geographical), County & Civil Parish Boundary, Civil Parish Boundary, Admin. County or County Bor. Boundary, London Borough Boundary, Symbol marking point where boundary mereing changes

<i>BH</i> Beer House	<i>P</i> Pillar, Pole or Post
<i>BP, BS</i> Boundary Post or Stone	<i>PO</i> Post Office
<i>Cn, C</i> Capstan, Crane	<i>PC</i> Public Convenience
<i>Chy</i> Chimney	<i>PH</i> Public House
<i>D Fn</i> Drinking Fountain	<i>Pp</i> Pump
<i>EI P</i> Electricity Pillar or Post	<i>SB, S Br</i> Signal Box or Bridge
<i>FAP</i> Fire Alarm Pillar	<i>SP, SL</i> Signal Post or Light
<i>FB</i> Foot Bridge	<i>Spr</i> Spring
<i>GP</i> Guide Post	<i>Tk</i> Tank or Track
<i>H</i> Hydrant or Hydraulic	<i>TCB</i> Telephone Call Box
<i>LC</i> Level Crossing	<i>TCP</i> Telephone Call Post
<i>MH</i> Manhole	<i>Tr</i> Trough
<i>MP</i> Mile Post or Mooring Post	<i>Wr Pt, Wr T</i> Water Point, Water Tap
<i>MS</i> Mile Stone	<i>W</i> Well
<i>NTL</i> Normal Tidal Limit	<i>Wd Pp</i> Wind Pump

Large-Scale National Grid Data 1:2,500 and 1:1,250

Cliff, Slopes, Top, Rock, Boulders, Positioned Boulder, Non-Coniferous Tree (surveyed), Coniferous Tree (surveyed), Non-Coniferous Trees (not surveyed), Coniferous Trees (not surveyed), Orchard Tree, Scrub, Bracken, Coppice, Osier, Reeds, Marsh, Saltings, Rough Grassland, Heath, Culvert, Direction of water flow, Triangulation Station, Antiquity (site of), Electricity Transmission Line, Electricity Pylon, Bench Mark, Buildings with Building Seed, Roofed Building, Glazed Roof Building

Civil parish/community boundary, District boundary, County boundary, Boundary post/stone, Boundary mereing symbol (note: these always appear in opposed pairs or groups of three)

<i>Bks</i> Barracks	<i>P</i> Pillar, Pole or Post
<i>Bty</i> Battery	<i>PO</i> Post Office
<i>Cemy</i> Cemetery	<i>PC</i> Public Convenience
<i>Chy</i> Chimney	<i>Pp</i> Pump
<i>Cis</i> Cistern	<i>Ppg Sta</i> Pumping Station
<i>Dismtd Rly</i> Dismantled Railway	<i>PW</i> Place of Worship
<i>EI Gen Sta</i> Electricity Generating Station	<i>Sewage Ppg Sta</i> Sewage Pumping Station
<i>EI P</i> Electricity Pole, Pillar	<i>SB, S Br</i> Signal Box or Bridge
<i>EI Sub Sta</i> Electricity Sub Station	<i>SP, SL</i> Signal Post or Light
<i>FB</i> Filter Bed	<i>Spr</i> Spring
<i>Fn / D Fn</i> Fountain / Drinking Ftn.	<i>Tk</i> Tank or Track
<i>Gas Gov</i> Gas Valve Compound	<i>Tr</i> Trough
<i>GVC</i> Gas Governor	<i>Wd Pp</i> Wind Pump
<i>GP</i> Guide Post	<i>Wr Pt, Wr T</i> Water Point, Water Tap
<i>MH</i> Manhole	<i>Wks</i> Works (building or area)
<i>MP, MS</i> Mile Post or Mile Stone	<i>W</i> Well



Historical Mapping & Photography included:

Mapping Type	Scale	Date	Pg
Nottinghamshire	1:2,500	1885	2
Lincolnshire	1:2,500	1886	3
Nottinghamshire	1:2,500	1899	4
Lincolnshire	1:2,500	1920	5
Ordnance Survey Plan	1:2,500	1974	6
Large-Scale National Grid Data	1:2,500	1994	7

Historical Map - Segment E6

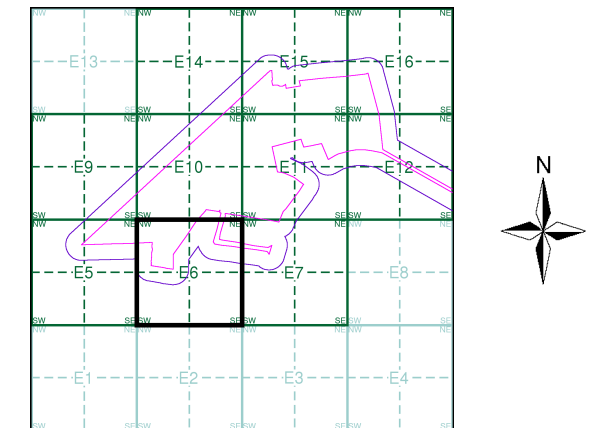

Order Details

Order Number: 298001007_1_1
 Customer Ref: 21-1098.04
 National Grid Reference: 483820, 381060
 Slice: E
 Site Area (Ha): 471.82
 Search Buffer (m): 100

Site Details

West Barton 1



Tel: 0844 844 9952
 Fax: 0844 844 9951
 Web: [REDACTED]

483200

483400

483600

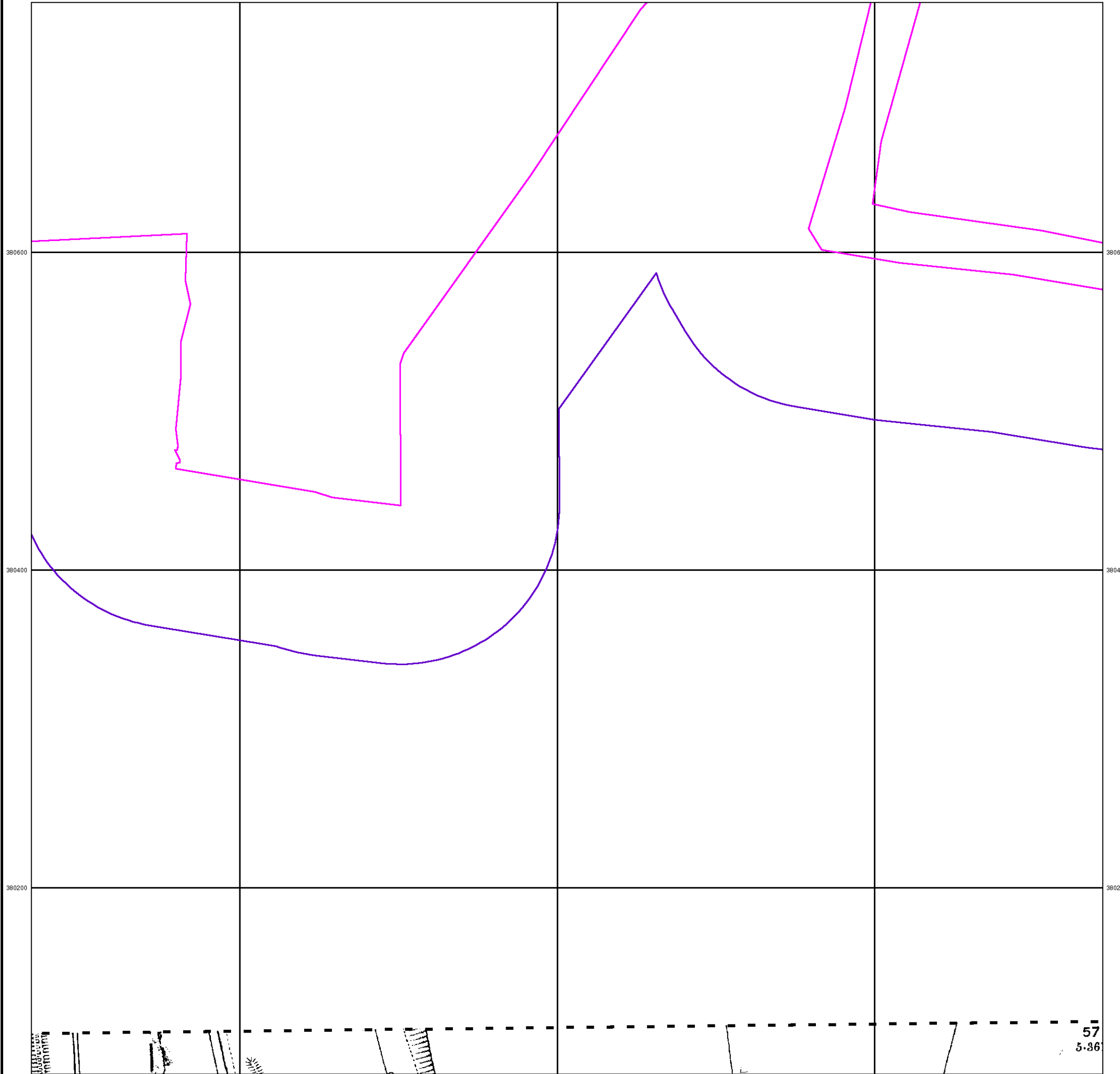

© Crown copyright and Landmark Information Group Limited 2022. All Rights Reserved.

0 100 m



Nottinghamshire

Published 1885

Source map scale - 1:2,500

The historical maps shown were reproduced from maps predominantly held at the scale adopted for England, Wales and Scotland in the 1840's. In 1854 the 1:2,500 scale was adopted for mapping urban areas and by 1896 it covered the whole of what were considered to be the cultivated parts of Great Britain. The published date given below is often some years later than the surveyed date. Before 1938, all OS maps were based on the Cassini Projection, with independent surveys of a single county or group of counties, giving rise to significant inaccuracies in outlying areas.

Map Name(s) and Date(s)

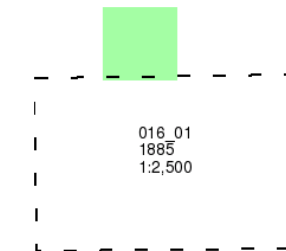

Historical Map - Segment E6

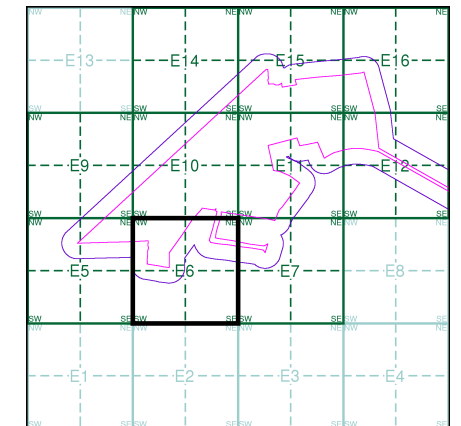

Order Details

Order Number: 298001007_1_1
 Customer Ref: 21-1098.04
 National Grid Reference: 483820, 381060
 Slice: E
 Site Area (Ha): 471.82
 Search Buffer (m): 100

Site Details

West Barton 1



Tel: 0844 844 9952
 Fax: 0844 844 9951
 Web: [REDACTED]

Lincolnshire
Published 1886

Source map scale - 1:2,500

The historical maps shown were reproduced from maps predominantly held at the scale adopted for England, Wales and Scotland in the 1840's. In 1854 the 1:2,500 scale was adopted for mapping urban areas and by 1896 it covered the whole of what were considered to be the cultivated parts of Great Britain. The published date given below is often some years later than the surveyed date. Before 1938, all OS maps were based on the Cassini Projection, with independent surveys of a single county or group of counties, giving rise to significant inaccuracies in outlying areas.

Map Name(s) and Date(s)

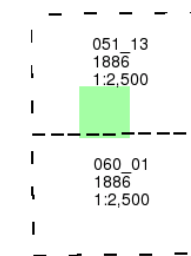

Historical Map - Segment E6

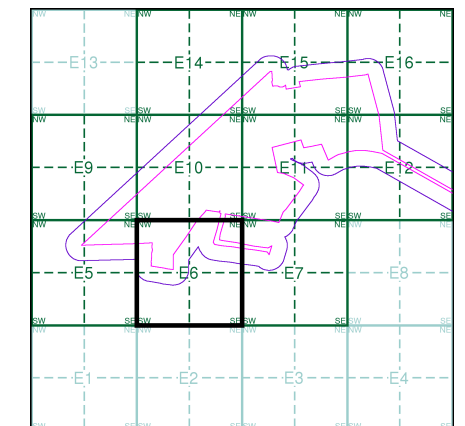

Order Details

Order Number: 298001007_1_1
 Customer Ref: 21-1098.04
 National Grid Reference: 483820, 381060
 Slice: E
 Site Area (Ha): 471.82
 Search Buffer (m): 100

Site Details

West Barton 1

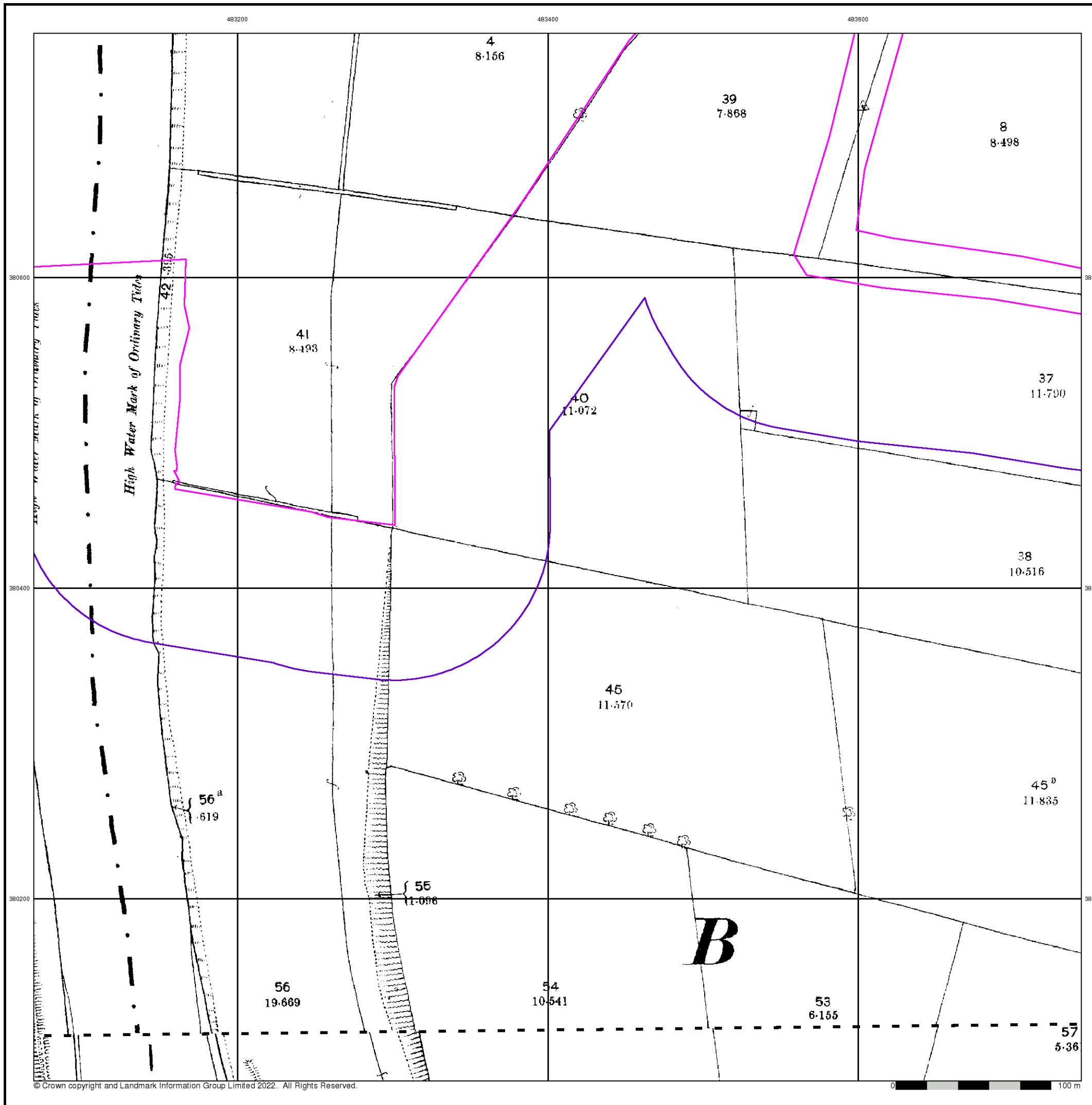

Nottinghamshire

Published 1899

Source map scale - 1:2,500

The historical maps shown were reproduced from maps predominantly held at the scale adopted for England, Wales and Scotland in the 1840's. In 1854 the 1:2,500 scale was adopted for mapping urban areas and by 1896 it covered the whole of what were considered to be the cultivated parts of Great Britain. The published date given below is often some years later than the surveyed date. Before 1938, all OS maps were based on the Cassini Projection, with independent surveys of a single county or group of counties, giving rise to significant inaccuracies in outlying areas.

Map Name(s) and Date(s)

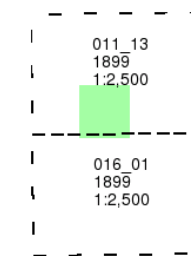

Historical Map - Segment E6

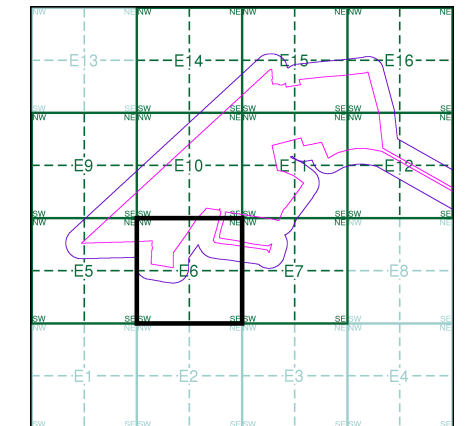

Order Details

Order Number: 298001007_1_1
 Customer Ref: 21-1098.04
 National Grid Reference: 483820, 381060
 Slice: E
 Site Area (Ha): 471.82
 Search Buffer (m): 100

Site Details

West Barton 1

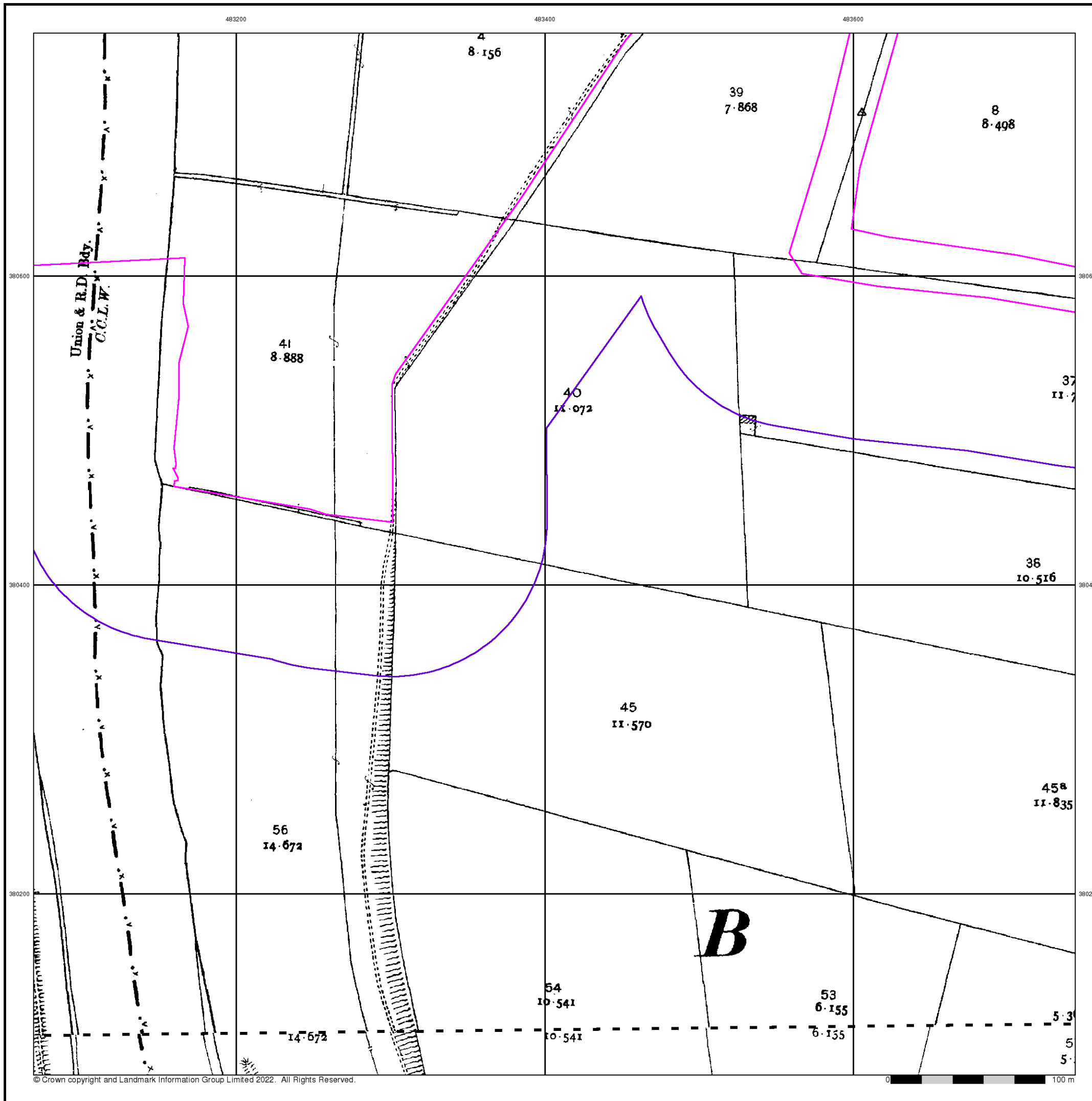

Lincolnshire
Published 1920

Source map scale - 1:2,500

The historical maps shown were reproduced from maps predominantly held at the scale adopted for England, Wales and Scotland in the 1840's. In 1854 the 1:2,500 scale was adopted for mapping urban areas and by 1896 it covered the whole of what were considered to be the cultivated parts of Great Britain. The published date given below is often some years later than the surveyed date. Before 1938, all OS maps were based on the Cassini Projection, with independent surveys of a single county or group of counties, giving rise to significant inaccuracies in outlying areas.

Map Name(s) and Date(s)

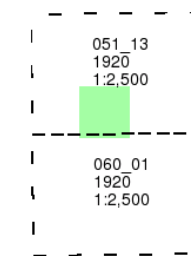

Historical Map - Segment E6

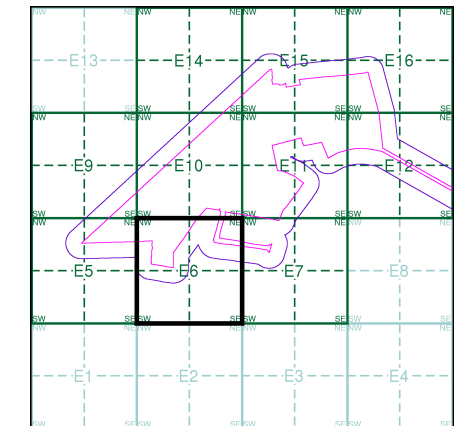

Order Details

Order Number: 298001007_1_1
 Customer Ref: 21-1098.04
 National Grid Reference: 483820, 381060
 Slice: E
 Site Area (Ha): 471.82
 Search Buffer (m): 100

Site Details

West Barton 1

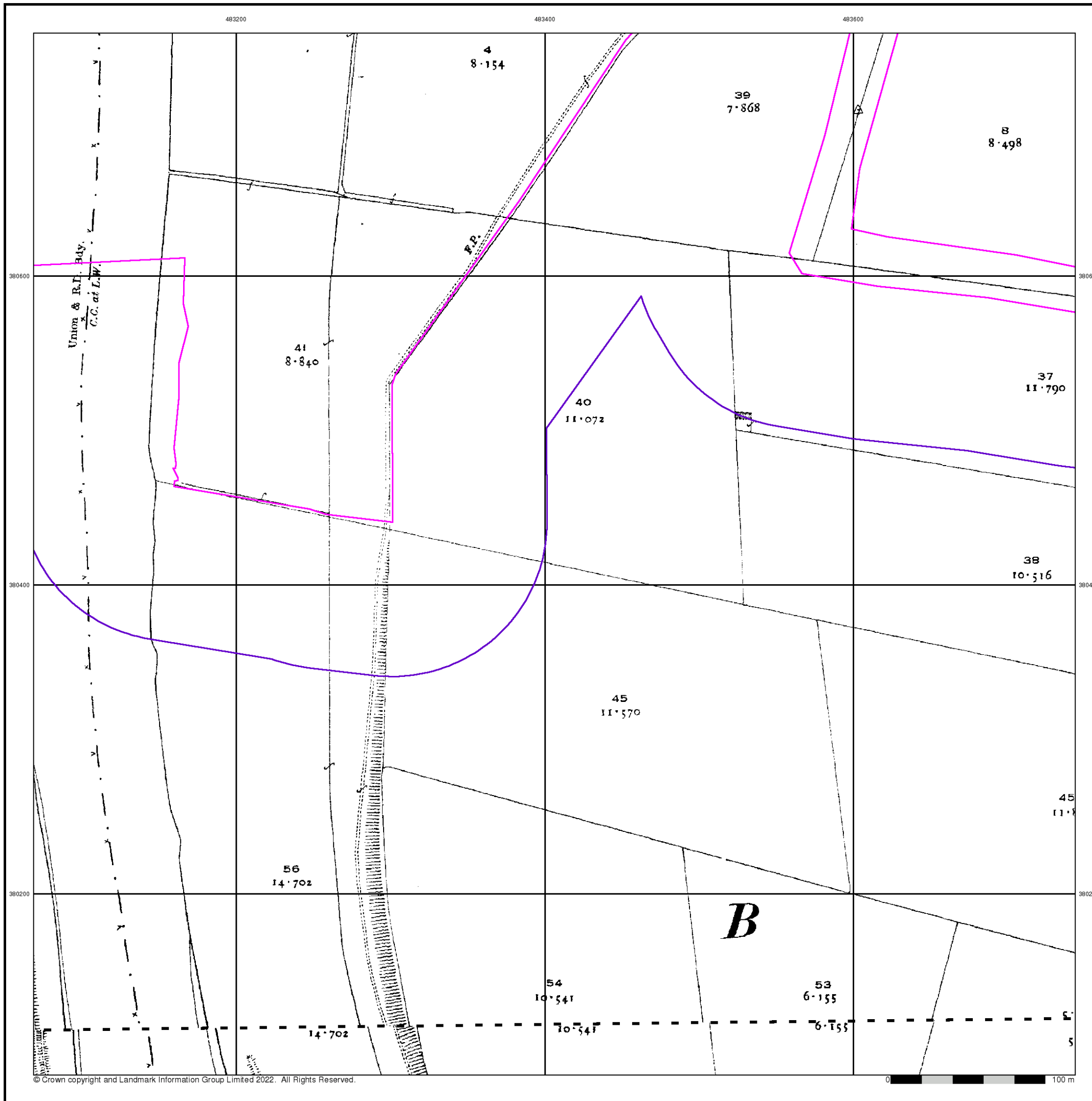

Ordnance Survey Plan

Published 1974

Source map scale - 1:2,500

The historical maps shown were reproduced from maps predominantly held at the scale adopted for England, Wales and Scotland in the 1840's. In 1854 the 1:2,500 scale was adopted for mapping urban areas and by 1896 it covered the whole of what were considered to be the cultivated parts of Great Britain. The published date given below is often some years later than the surveyed date. Before 1938, all OS maps were based on the Cassini Projection, with independent surveys of a single county or group of counties, giving rise to significant inaccuracies in outlying areas.

Map Name(s) and Date(s)

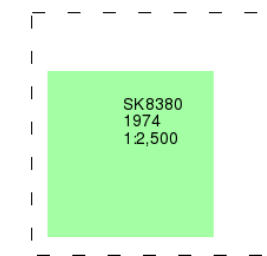

Historical Map - Segment E6

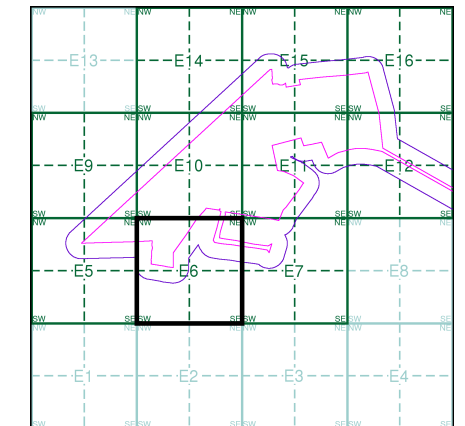

Order Details

Order Number: 298001007_1_1
 Customer Ref: 21-1098.04
 National Grid Reference: 483820, 381060
 Slice: E
 Site Area (Ha): 471.82
 Search Buffer (m): 100

Site Details

West Barton 1

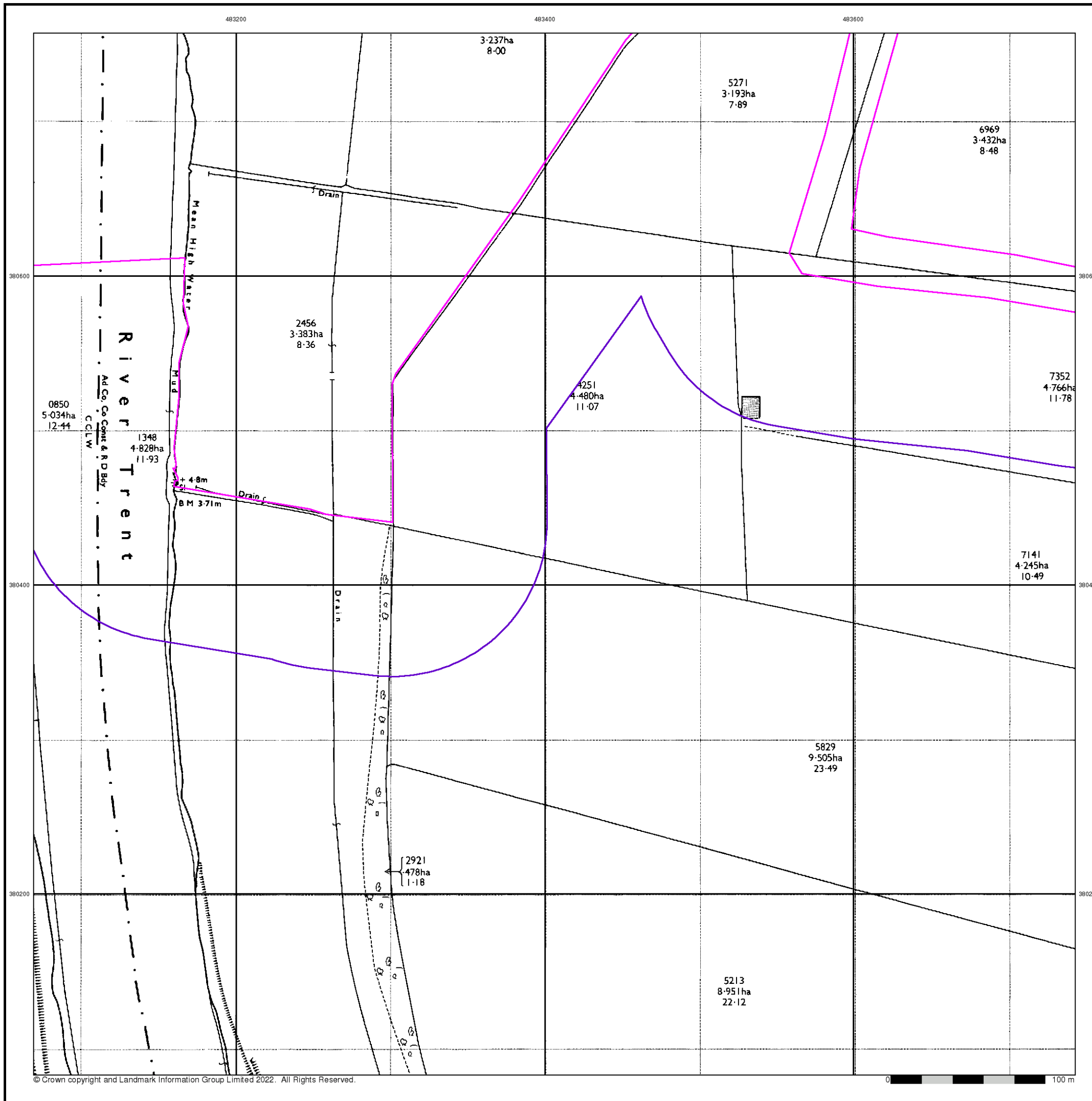

Large-Scale National Grid Data

Published 1994

Source map scale - 1:2,500

'Large Scale National Grid Data' superseded SIM cards (Ordnance Survey's 'Survey of Information on Microfilm') in 1992, and continued to be produced until 1999. These maps were the fore-runners of digital mapping and so provide detailed information on houses and roads, but tend to show less topographic features such as vegetation. These maps were produced at both 1:2,500 and 1:1,250 scales.

Map Name(s) and Date(s)

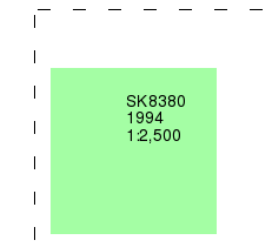

Historical Map - Segment E6

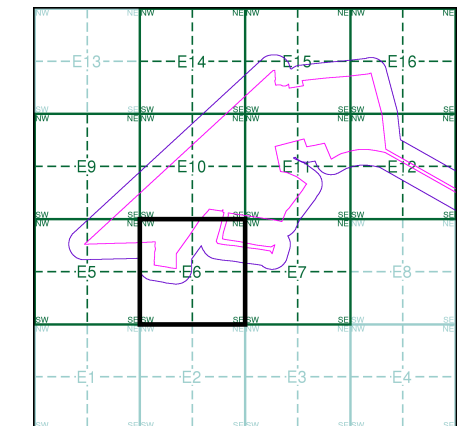

Order Details

Order Number: 298001007_1_1
 Customer Ref: 21-1098.04
 National Grid Reference: 483820, 381060
 Slice: E
 Site Area (Ha): 471.82
 Search Buffer (m): 100

Site Details

West Barton 1

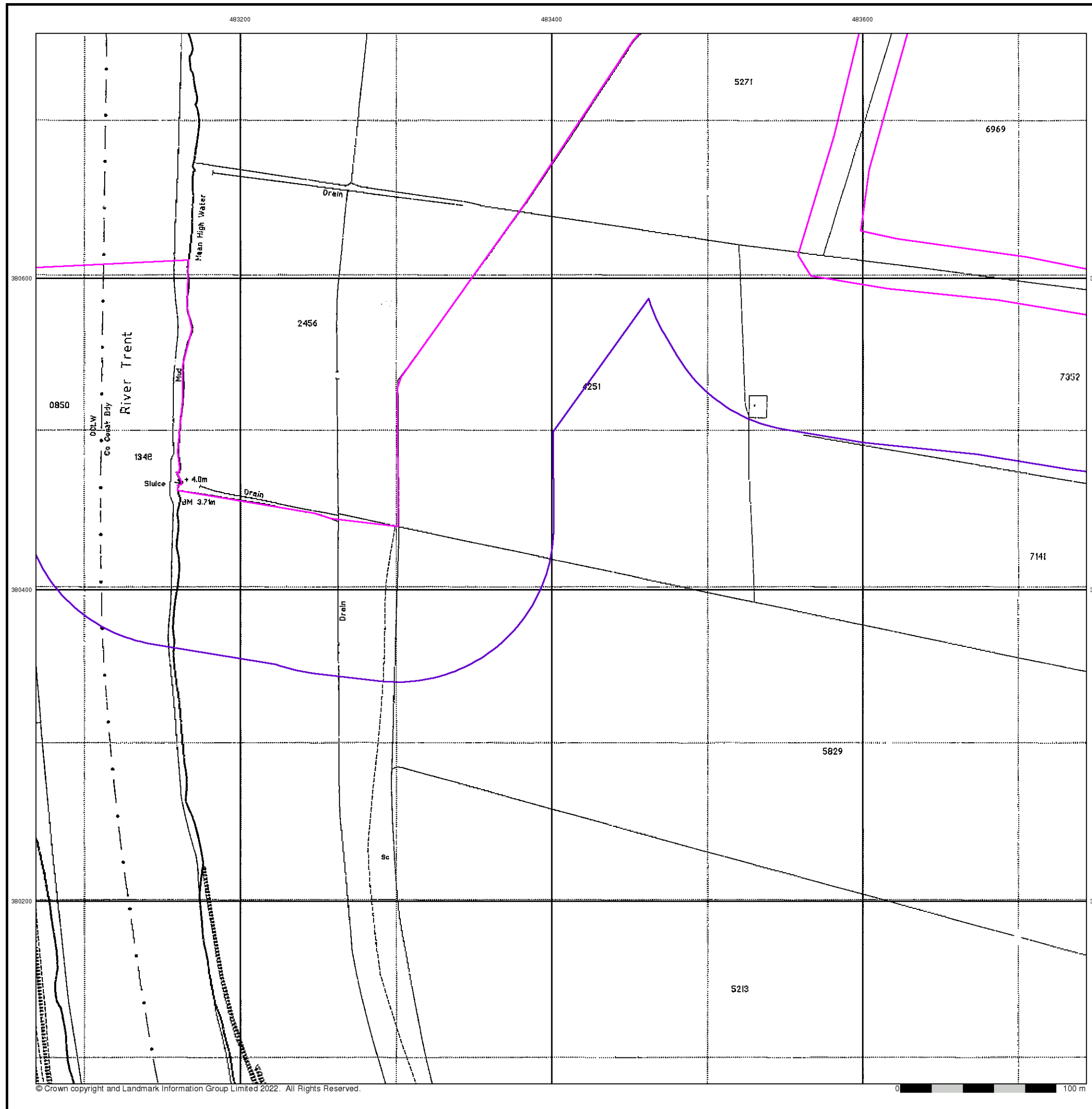

Historical Mapping Legends

Ordnance Survey County Series and Ordnance Survey Plan 1:2,500

Quarry **Gravel Pit** **Sand Pit**
Clay Pit **Shingle** **Refuse Heap**
Sloping Masonry **Flat Rock**
Marsh **Reeds** **Osiers**
Rough Pasture **Furze** **Wood**
Mixed Wood **Brushwood** **Orchard**
Fir **Ford** **Stepping Stones**
Ferry **Waterfall** **Lock**
Trig. Station **Altitude at Trig. Station**
B.M. 325.9 **Bench Mark** **Surface Level**
Arrow denotes flow of water **Antiquities (site of)**
Cutting **Embankment**
Railway crossing Road **Level Crossing** **Road crossing Railway**
Railway crossing River or Canal **Road over single stream** **Road over River or Canal**
County Boundary (Geographical)
County & Civil Parish Boundary
Administrative County & Civil Parish Boundary
County Borough Boundary (England)
County Burgh Boundary (Scotland)
Boundary Post or Stone **Police Call Box**
B.R. Bridle Road **Pump**
E.P. Electricity Pylon **S.P. Signal Post**
F.B. Foot Bridge **Sl. Sluice**
F.P. Foot Path **Sp. Spring**
G.P. Guide Post or Board **T.C.B. Telephone Call Box**
M.S. Mile Stone **Tr. Trough**
M.P. M.R. Mooring Post or Ring **W. Well**

Ordnance Survey Plan, Additional SIMs and Supply of Unpublished Survey Information 1:2,500 and 1:1,250

Inactive Quarry, Chalk Pit or Clay Pit **Active Quarry, Chalk Pit or Clay Pit**
Rock **Boulders**
Cliff **Slopes** **Top**
Roofed Building **Glazed Roof Building**
Sloping Masonry **Archway**
Non-Coniferous Tree (surveyed) **Coniferous Tree (surveyed)**
Non-Coniferous Trees (not surveyed) **Coniferous Trees (not surveyed)**
Orchard Tree **Scrub** **Bracken**
Coppice, Osier **Reeds** **Marsh, Saltings**
Rough Grassland **Heath** **Culvert**
Direction of water flow **Bench Mark** **Antiquity (site of)**
Cave Entrance **Triangulation Station** **Electricity Pylon**
Electricity Transmission Line
County Boundary (Geographical)
County & Civil Parish Boundary
Civil Parish Boundary
Admin. County or County Bor. Boundary
London Borough Boundary
Symbol marking point where boundary mereing changes
Beer House **Pillar, Pole or Post**
Boundary Post or Stone **Post Office**
Capstan, Crane **Public Convenience**
Chimney **Public House**
Drinking Fountain **Pump**
Electricity Pillar or Post **Signal Box or Bridge**
Fire Alarm Pillar **Signal Post or Light**
Foot Bridge **Spring**
Guide Post **Tank or Track**
Hydrant or Hydraulic **Telephone Call Box**
Level Crossing **Telephone Call Post**
Manhole **Trough**
Mile Post or Mooring Post **Water Point, Water Tap**
Mile Stone **Well**
Normal Tidal Limit **Wind Pump**

Large-Scale National Grid Data 1:2,500 and 1:1,250

Cliff **Slopes** **Top**
Rock **Rock (scattered)**
Boulders **Boulders (scattered)**
Positioned Boulder **Scree**
Non-Coniferous Tree (surveyed) **Coniferous Tree (surveyed)**
Non-Coniferous Trees (not surveyed) **Coniferous Trees (not surveyed)**
Orchard Tree **Scrub** **Bracken**
Coppice, Osier **Reeds** **Marsh, Saltings**
Rough Grassland **Heath** **Culvert**
Direction of water flow **Triangulation Station** **Antiquity (site of)**
Electricity Transmission Line **Electricity Pylon**
Bench Mark **Buildings with Building Seed**
Roofed Building **Glazed Roof Building**
Civil parish/community boundary
District boundary
County boundary
Boundary post/stone
Boundary mereing symbol (note: these always appear in opposed pairs or groups of three)
Barracks **Pillar, Pole or Post**
Battery **Post Office**
Cemetery **Public Convenience**
Chimney **Pump**
Cistern **Pumping Station**
Dismtd Rly **Place of Worship**
Electricity Generating Station **Sewage Ppg Sta** **Sewage Pumping Station**
Electricity Pole, Pillar **Signal Box or Bridge**
Electricity Sub Station **Signal Post or Light**
Filter Bed **Spring**
Fountain / Drinking Ftn. **Tank or Track**
Gas Valve Compound **Trough**
Gas Governor **Wind Pump**
Guide Post **Water Point, Water Tap**
Manhole **Works (building or area)**
Mile Post or Mile Stone **Well**

Historical Mapping & Photography included:

Mapping Type	Scale	Date	Pg
Nottinghamshire	1:2,500	1885	2
Lincolnshire	1:2,500	1886	3
Nottinghamshire	1:2,500	1899	4
Lincolnshire	1:2,500	1920	5
Ordnance Survey Plan	1:2,500	1974	6
Large-Scale National Grid Data	1:2,500	1994	7

Historical Map - Segment E7

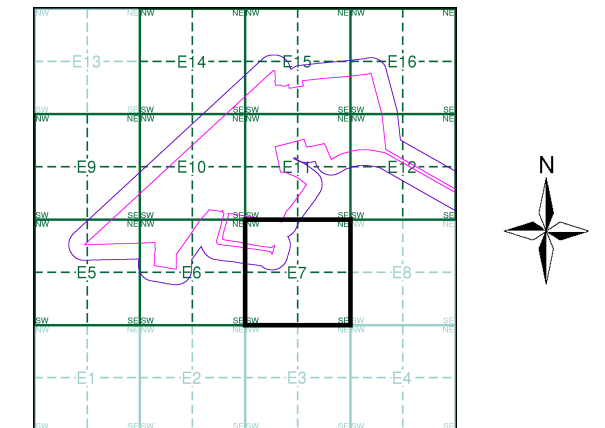

Order Details

Order Number: 298001007_1_1
 Customer Ref: 21-1098.04
 National Grid Reference: 483820, 381060
 Slice: E
 Site Area (Ha): 471.82
 Search Buffer (m): 100

Site Details

West Barton 1

Nottinghamshire

Published 1885

Source map scale - 1:2,500

The historical maps shown were reproduced from maps predominantly held at the scale adopted for England, Wales and Scotland in the 1840's. In 1854 the 1:2,500 scale was adopted for mapping urban areas and by 1896 it covered the whole of what were considered to be the cultivated parts of Great Britain. The published date given below is often some years later than the surveyed date. Before 1938, all OS maps were based on the Cassini Projection, with independent surveys of a single county or group of counties, giving rise to significant inaccuracies in outlying areas.

Map Name(s) and Date(s)

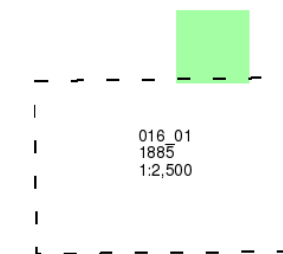

Historical Map - Segment E7

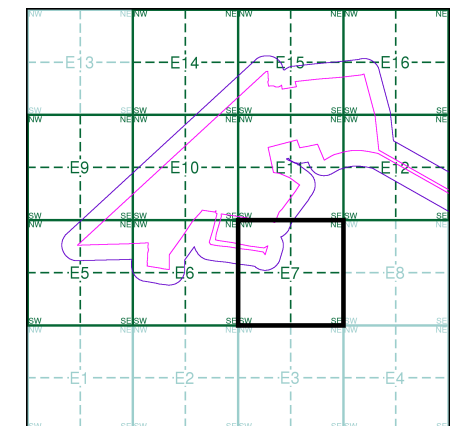

Order Details

Order Number: 298001007_1_1
 Customer Ref: 21-1098.04
 National Grid Reference: 483820, 381060
 Slice: E
 Site Area (Ha): 471.82
 Search Buffer (m): 100

Site Details

West Barton 1

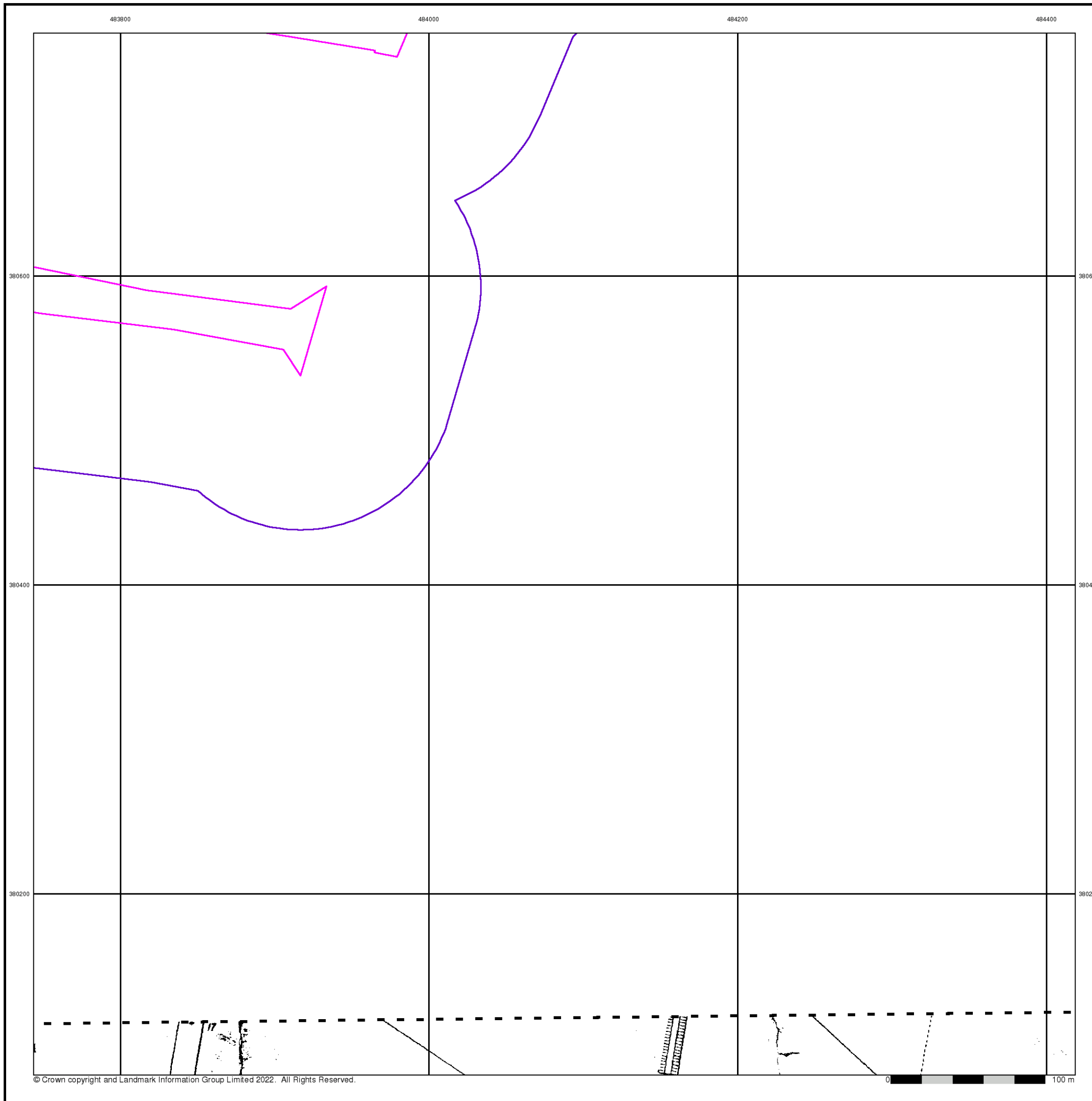

Lincolnshire

Published 1886

Source map scale - 1:2,500

The historical maps shown were reproduced from maps predominantly held at the scale adopted for England, Wales and Scotland in the 1840's. In 1854 the 1:2,500 scale was adopted for mapping urban areas and by 1896 it covered the whole of what were considered to be the cultivated parts of Great Britain. The published date given below is often some years later than the surveyed date. Before 1938, all OS maps were based on the Cassini Projection, with independent surveys of a single county or group of counties, giving rise to significant inaccuracies in outlying areas.

Map Name(s) and Date(s)

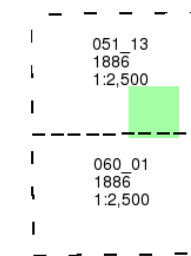

Historical Map - Segment E7

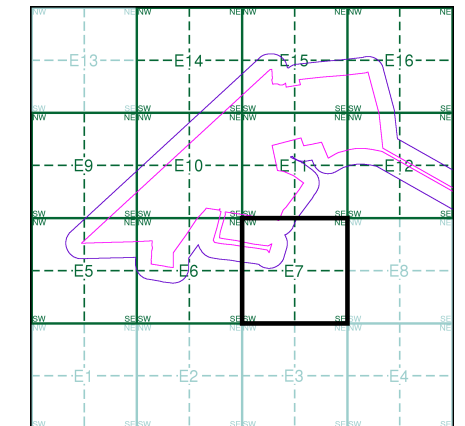

Order Details

Order Number: 298001007_1_1
 Customer Ref: 21-1098.04
 National Grid Reference: 483820, 381060
 Slice: E
 Site Area (Ha): 471.82
 Search Buffer (m): 100

Site Details

West Barton 1

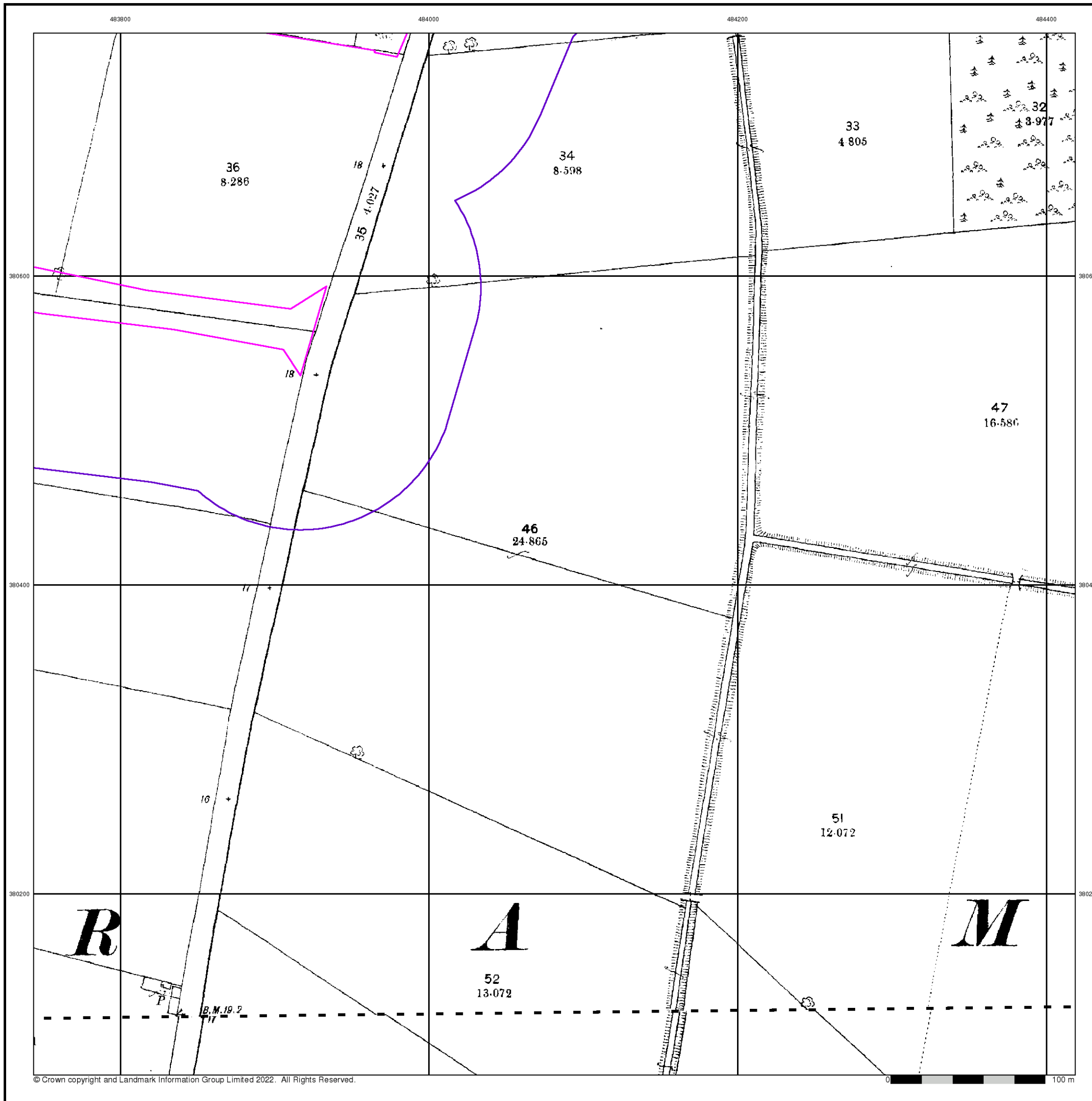

Nottinghamshire

Published 1899

Source map scale - 1:2,500

The historical maps shown were reproduced from maps predominantly held at the scale adopted for England, Wales and Scotland in the 1840's. In 1854 the 1:2,500 scale was adopted for mapping urban areas and by 1896 it covered the whole of what were considered to be the cultivated parts of Great Britain. The published date given below is often some years later than the surveyed date. Before 1938, all OS maps were based on the Cassini Projection, with independent surveys of a single county or group of counties, giving rise to significant inaccuracies in outlying areas.

Map Name(s) and Date(s)

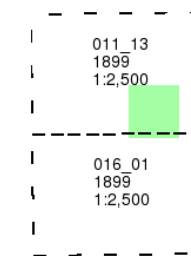

Historical Map - Segment E7

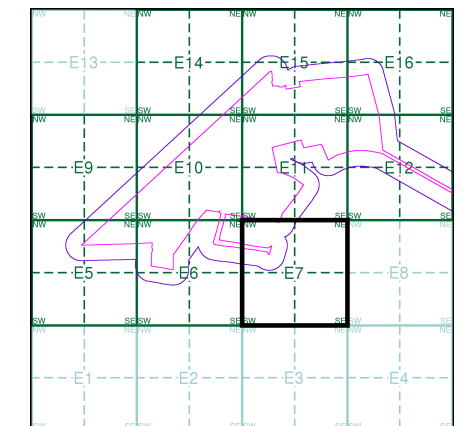

Order Details

Order Number: 298001007_1_1
 Customer Ref: 21-1098.04
 National Grid Reference: 483820, 381060
 Slice: E
 Site Area (Ha): 471.82
 Search Buffer (m): 100

Site Details

West Barton 1

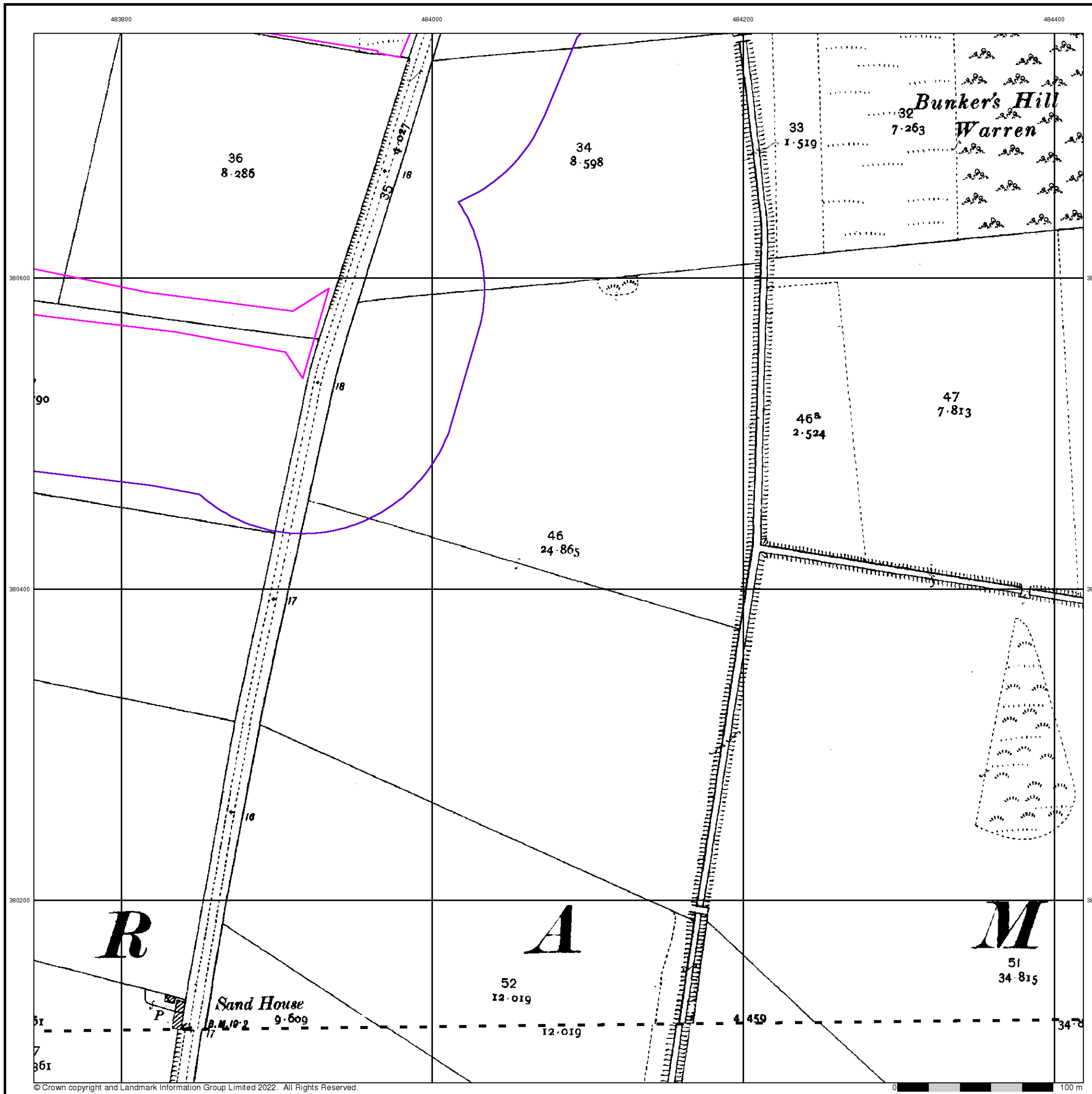

Lincolnshire

Published 1920

Source map scale - 1:2,500

The historical maps shown were reproduced from maps predominantly held at the scale adopted for England, Wales and Scotland in the 1840's. In 1854 the 1:2,500 scale was adopted for mapping urban areas and by 1896 it covered the whole of what were considered to be the cultivated parts of Great Britain. The published date given below is often some years later than the surveyed date. Before 1938, all OS maps were based on the Cassini Projection, with independent surveys of a single county or group of counties, giving rise to significant inaccuracies in outlying areas.

Map Name(s) and Date(s)

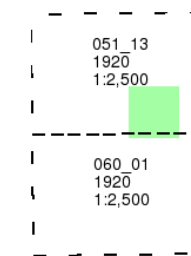

Historical Map - Segment E7

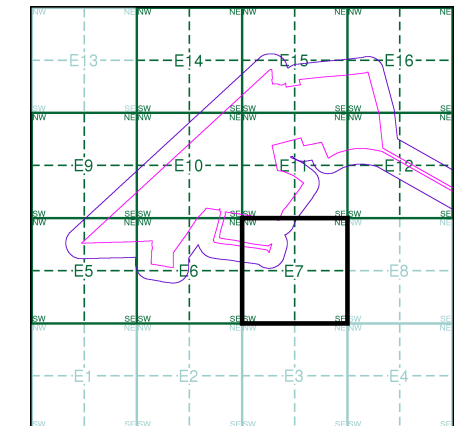

Order Details

Order Number: 298001007_1_1
 Customer Ref: 21-1098.04
 National Grid Reference: 483820, 381060
 Slice: E
 Site Area (Ha): 471.82
 Search Buffer (m): 100

Site Details

West Barton 1

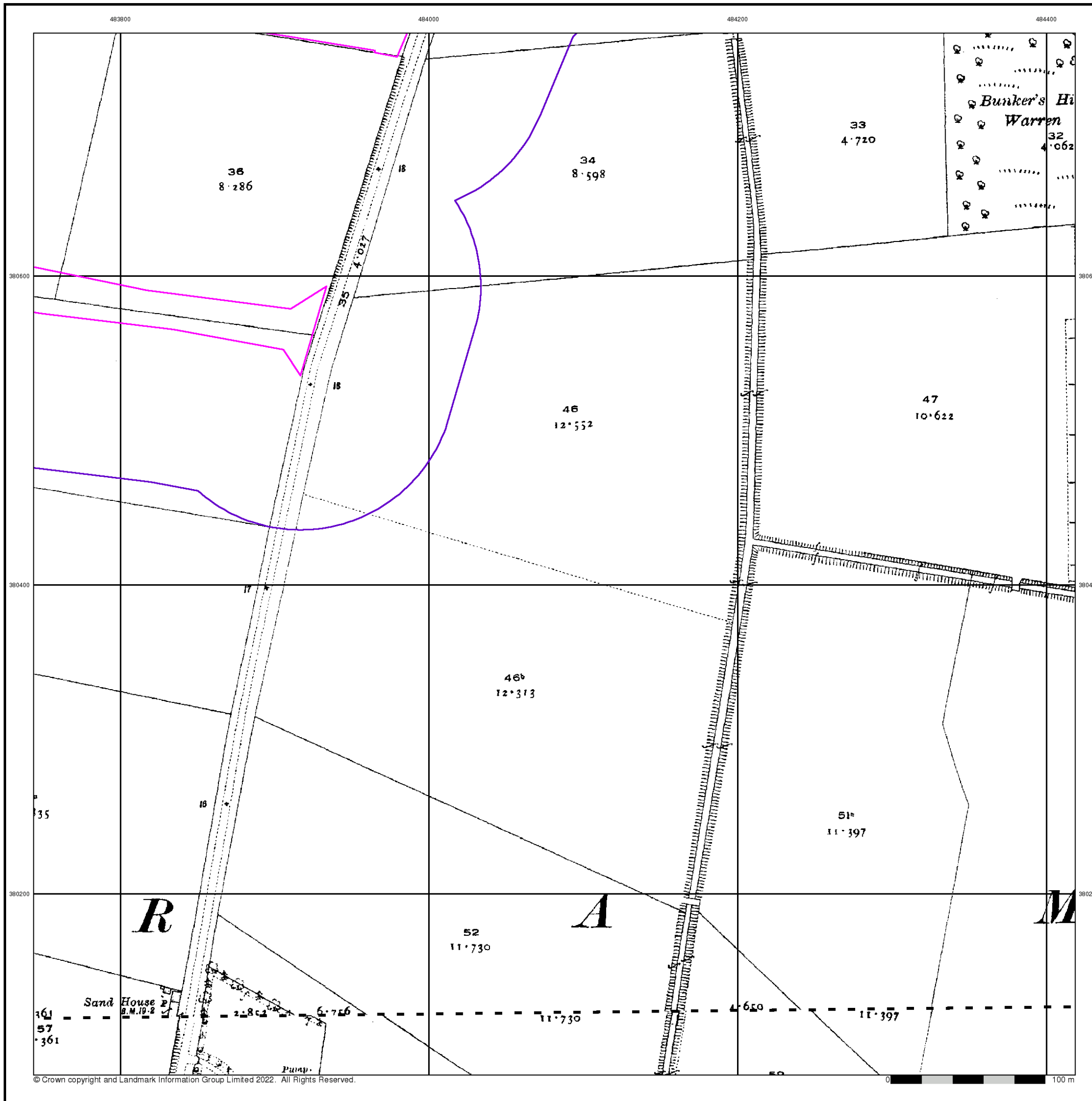

Ordnance Survey Plan

Published 1974

Source map scale - 1:2,500

The historical maps shown were reproduced from maps predominantly held at the scale adopted for England, Wales and Scotland in the 1840's. In 1854 the 1:2,500 scale was adopted for mapping urban areas and by 1896 it covered the whole of what were considered to be the cultivated parts of Great Britain. The published date given below is often some years later than the surveyed date. Before 1938, all OS maps were based on the Cassini Projection, with independent surveys of a single county or group of counties, giving rise to significant inaccuracies in outlying areas.

Map Name(s) and Date(s)

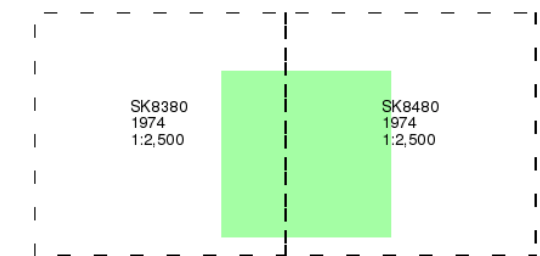

Historical Map - Segment E7

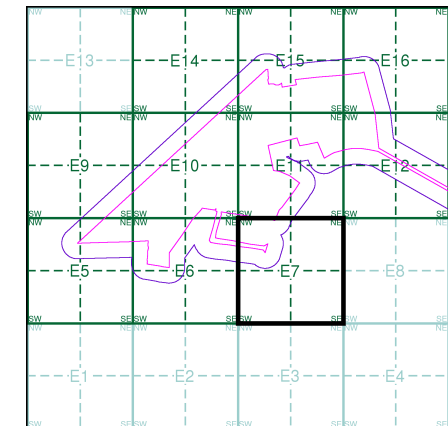

Order Details

Order Number: 298001007_1_1
 Customer Ref: 21-1098.04
 National Grid Reference: 483820, 381060
 Slice: E
 Site Area (Ha): 471.82
 Search Buffer (m): 100

Site Details

West Barton 1

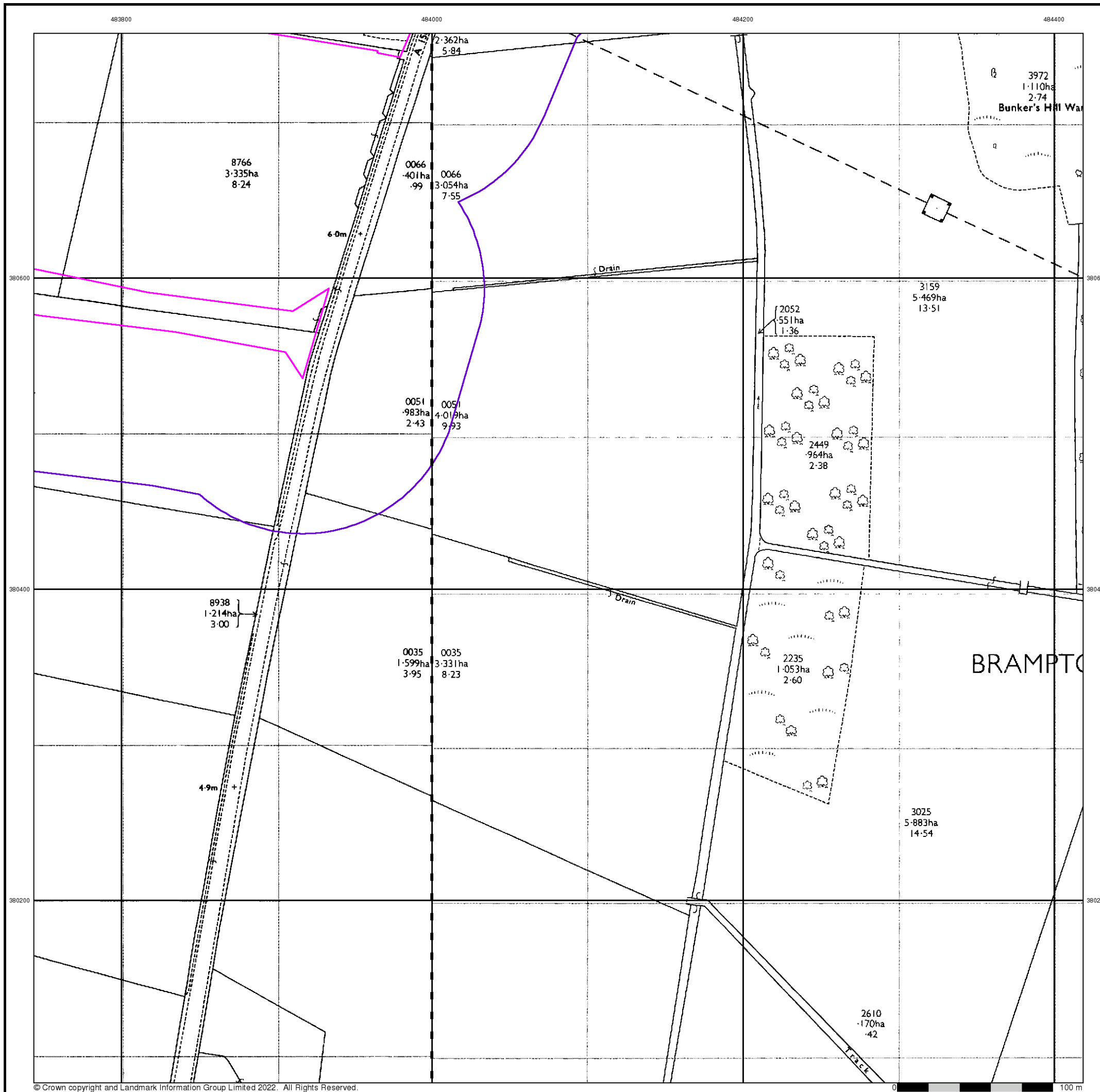

Large-Scale National Grid Data

Published 1994

Source map scale - 1:2,500

'Large Scale National Grid Data' superseded SIM cards (Ordnance Survey's 'Survey of Information on Microfilm') in 1992, and continued to be produced until 1999. These maps were the fore-runners of digital mapping and so provide detailed information on houses and roads, but tend to show less topographic features such as vegetation. These maps were produced at both 1:2,500 and 1:1,250 scales.

Map Name(s) and Date(s)

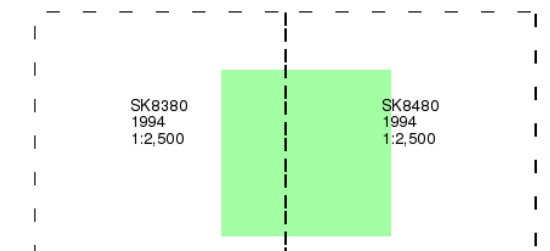

Historical Map - Segment E7

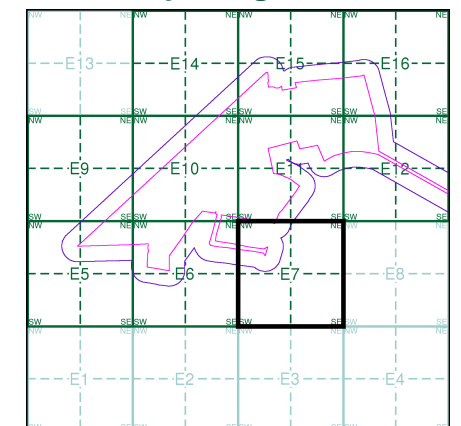

Order Details

Order Number: 298001007_1_1
 Customer Ref: 21-1098.04
 National Grid Reference: 483820, 381060
 Slice: E
 Site Area (Ha): 471.82
 Search Buffer (m): 100

Site Details

West Barton 1

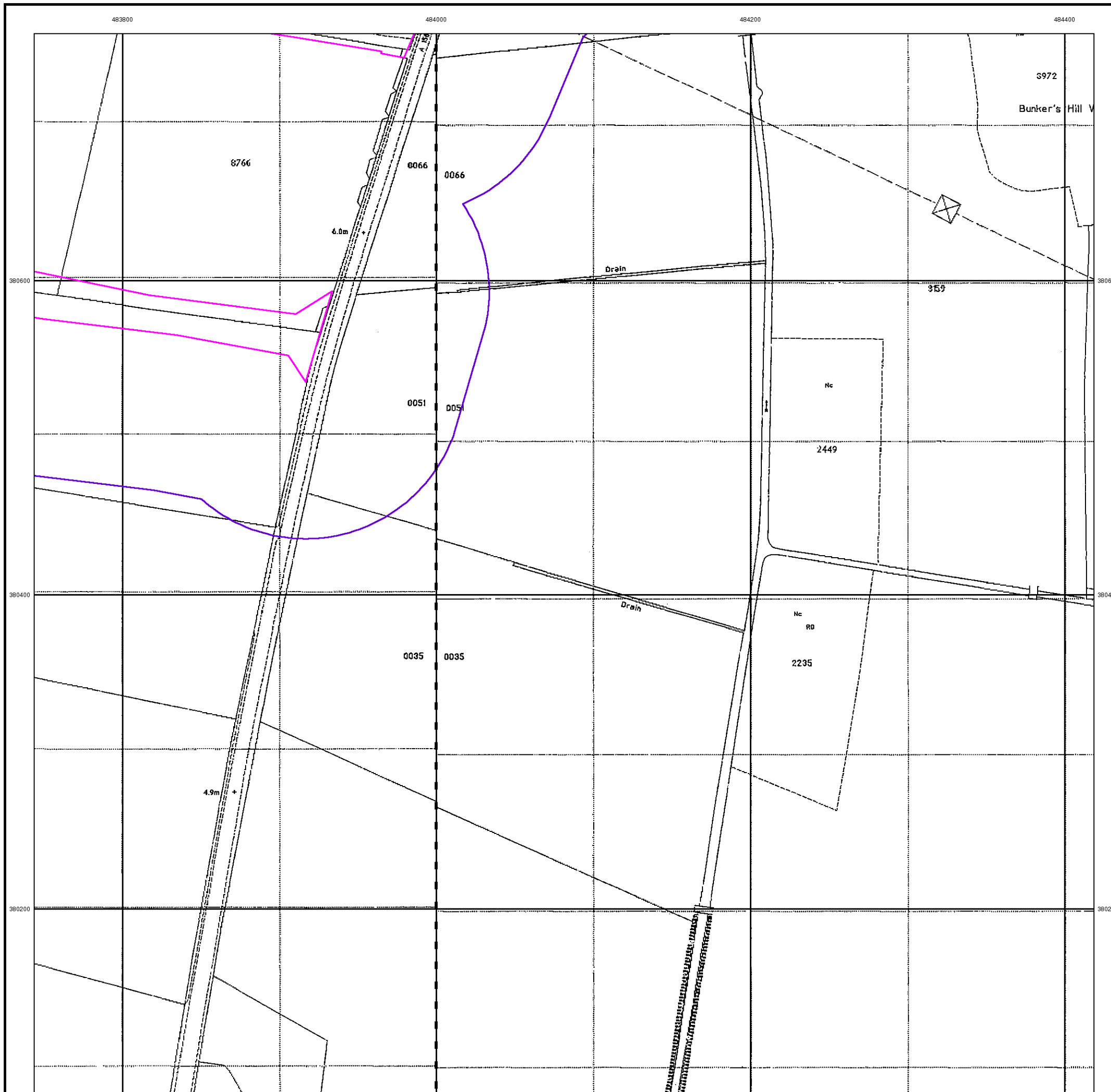

Historical Mapping Legends

Ordnance Survey County Series and Ordnance Survey Plan 1:2,500

Quarry **Gravel Pit** **Sand Pit**
Clay Pit **Shingle** **Refuse Heap**
Sloping Masonry **Flat Rock**
Marsh **Reeds** **Osiers**
Rough Pasture **Furze** **Wood**
Mixed Wood **Brushwood** **Orchard**
Fir **Ford** **Stepping Stones**
Ferry **Waterfall** **Lock**
Trig. Station **Altitude at Trig. Station**
B.M. 325.9 **Bench Mark** **Surface Level**
Arrow denotes flow of water **Antiquities (site of)**
Cutting **Embankment**
Railway crossing Road **Level Crossing** **Road crossing Railway**
Railway crossing River or Canal **Road over single stream** **Road over River or Canal**
County Boundary (Geographical)
County & Civil Parish Boundary
Administrative County & Civil Parish Boundary
County Borough Boundary (England)
County Burgh Boundary (Scotland)
Boundary Post or Stone **Police Call Box**
B.R. Bridle Road **P Pump**
E.P. Electricity Pylon **S.P. Signal Post**
F.B. Foot Bridge **Sl. Sluice**
F.P. Foot Path **Sp. Spring**
G.P. Guide Post or Board **T.C.B. Telephone Call Box**
M.S. Mile Stone **Tr. Trough**
M.P. M.R. Mooring Post or Ring **W Well**

Ordnance Survey Plan, Additional SIMs and Supply of Unpublished Survey Information 1:2,500 and 1:1,250

Inactive Quarry, Chalk Pit or Clay Pit **Active Quarry, Chalk Pit or Clay Pit**
Rock **Boulders**
Cliff **Slopes** **Top**
Roofed Building **Glazed Roof Building**
Sloping Masonry **Archway**
Non-Coniferous Tree (surveyed) **Coniferous Tree (surveyed)**
Non-Coniferous Trees (not surveyed) **Coniferous Trees (not surveyed)**
Orchard Tree **Scrub** **Bracken**
Coppice, Osier **Reeds** **Marsh, Saltings**
Rough Grassland **Heath** **Culvert**
Direction of water flow **Bench Mark** **Antiquity (site of)**
Cave Entrance **Triangulation Station** **Electricity Pylon**
Electricity Transmission Line
County Boundary (Geographical)
County & Civil Parish Boundary
Civil Parish Boundary
Admin. County or County Bor. Boundary
London Borough Boundary
Symbol marking point where boundary mereing changes
BH Beer House **P Pillar, Pole or Post**
BP, BS Boundary Post or Stone **PO Post Office**
Cn, C Capstan, Crane **PC Public Convenience**
Chy Chimney **PH Public House**
D Fn Drinking Fountain **Pp Pump**
EI P Electricity Pillar or Post **SB, S Br Signal Box or Bridge**
FAP Fire Alarm Pillar **SP, SL Signal Post or Light**
FB Foot Bridge **Spr Spring**
GP Guide Post **Tk Tank or Track**
H Hydrant or Hydraulic **TCB Telephone Call Box**
LC Level Crossing **TCP Telephone Call Post**
MH Manhole **Tr Trough**
MP Mile Post or Mooring Post **Wr Pt, Wr T Water Point, Water Tap**
MS Mile Stone **W Well**
NTL Normal Tidal Limit **Wd Pp Wind Pump**

Large-Scale National Grid Data 1:2,500 and 1:1,250

Cliff **Slopes** **Top**
Rock **Rock (scattered)**
Boulders **Boulders (scattered)**
Positioned Boulder **Scree**
Non-Coniferous Tree (surveyed) **Coniferous Tree (surveyed)**
Non-Coniferous Trees (not surveyed) **Coniferous Trees (not surveyed)**
Orchard Tree **Scrub** **Bracken**
Coppice, Osier **Reeds** **Marsh, Saltings**
Rough Grassland **Heath** **Culvert**
Direction of water flow **Triangulation Station** **Antiquity (site of)**
Electricity Transmission Line **Electricity Pylon**
BM 231.60m Bench Mark **Buildings with Building Seed**
Roofed Building **Glazed Roof Building**
Civil parish/community boundary
District boundary
County boundary
Boundary post/stone
Boundary mereing symbol (note: these always appear in opposed pairs or groups of three)
Bks Barracks **P Pillar, Pole or Post**
Bty Battery **PO Post Office**
Cemy Cemetery **PC Public Convenience**
Chy Chimney **Pp Pump**
Cis Cistern **Ppg Sta Pumping Station**
Dismtd Rly Dismantled Railway **PW Place of Worship**
EI Gen Sta Electricity Generating Station **Sewage Ppg Sta Sewage Pumping Station**
EI P Electricity Pole, Pillar **SB, S Br Signal Box or Bridge**
EI Sub Sta Electricity Sub Station **SP, SL Signal Post or Light**
FB Filter Bed **Spr Spring**
Fn / D Fn Fountain / Drinking Ftn. **Tk Tank or Track**
Gas Gov Gas Valve Compound **Tr Trough**
GVC Gas Governor **Wd Pp Wind Pump**
GP Guide Post **Wr Pt, Wr T Water Point, Water Tap**
MH Manhole **Wks Works (building or area)**
MP, MS Mile Post or Mile Stone **W Well**



Historical Mapping & Photography included:

Mapping Type	Scale	Date	Pg
Lincolnshire	1:2,500	1886	2
Nottinghamshire	1:2,500	1886	3
Nottinghamshire	1:2,500	1899	4
Lincolnshire	1:2,500	1920	5
Nottinghamshire	1:2,500	1920	6
Ordnance Survey Plan	1:2,500	1974 - 1975	7
Large-Scale National Grid Data	1:2,500	1994	8

Historical Map - Segment E9

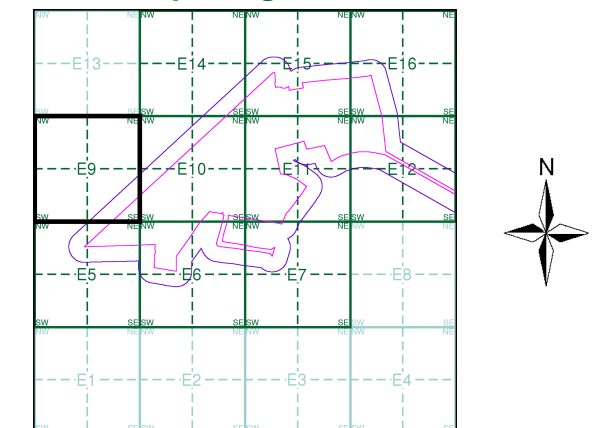

Order Details

Order Number: 298001007_1_1
 Customer Ref: 21-1098.04
 National Grid Reference: 483820, 381060
 Slice: E
 Site Area (Ha): 471.82
 Search Buffer (m): 100

Site Details

West Barton 1



Tel: 0844 844 9952
 Fax: 0844 844 9951
 Web: [REDACTED]

Lincolnshire

Published 1886

Source map scale - 1:2,500

The historical maps shown were reproduced from maps predominantly held at the scale adopted for England, Wales and Scotland in the 1840's. In 1854 the 1:2,500 scale was adopted for mapping urban areas and by 1896 it covered the whole of what were considered to be the cultivated parts of Great Britain. The published date given below is often some years later than the surveyed date. Before 1938, all OS maps were based on the Cassini Projection, with independent surveys of a single county or group of counties, giving rise to significant inaccuracies in outlying areas.

Map Name(s) and Date(s)

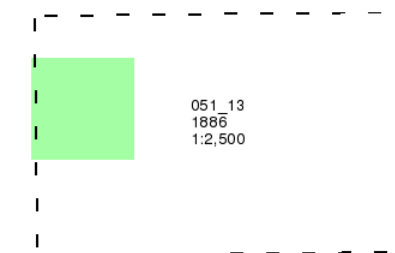

Historical Map - Segment E9

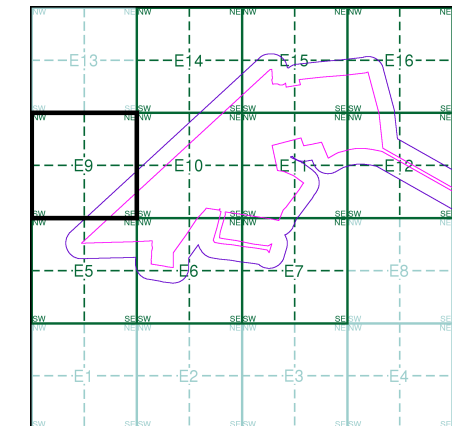

Order Details

Order Number: 298001007_1_1
 Customer Ref: 21-1098.04
 National Grid Reference: 483820, 381060
 Slice: E
 Site Area (Ha): 471.82
 Search Buffer (m): 100

Site Details

West Barton 1

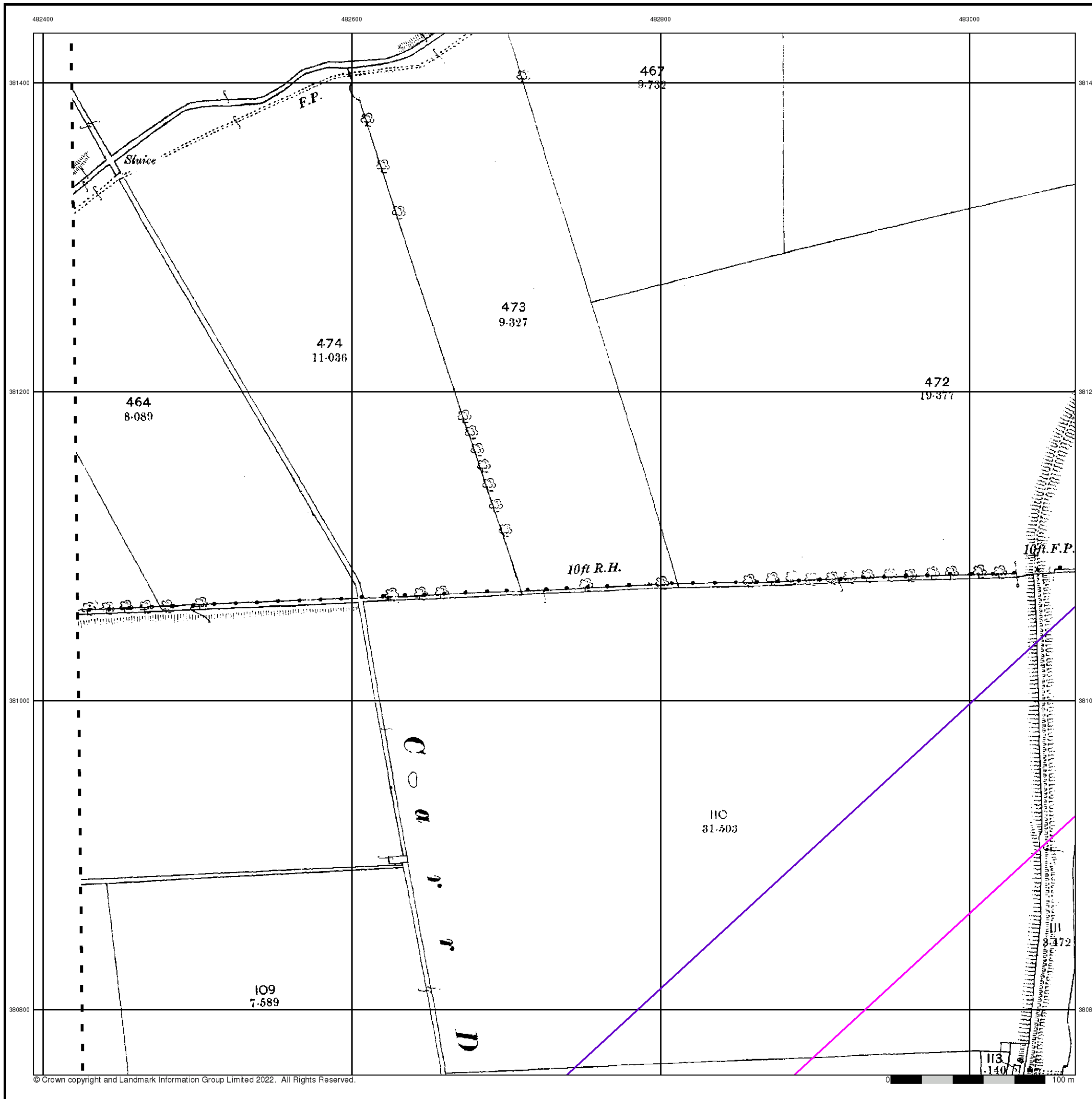

Nottinghamshire

Published 1886

Source map scale - 1:2,500

The historical maps shown were reproduced from maps predominantly held at the scale adopted for England, Wales and Scotland in the 1840's. In 1854 the 1:2,500 scale was adopted for mapping urban areas and by 1896 it covered the whole of what were considered to be the cultivated parts of Great Britain. The published date given below is often some years later than the surveyed date. Before 1938, all OS maps were based on the Cassini Projection, with independent surveys of a single county or group of counties, giving rise to significant inaccuracies in outlying areas.

Map Name(s) and Date(s)

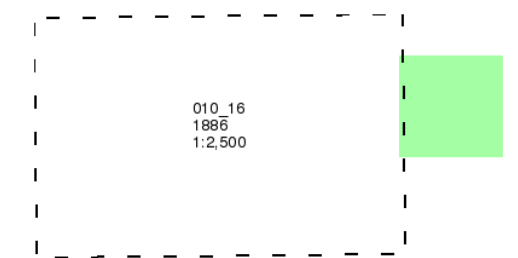

Historical Map - Segment E9

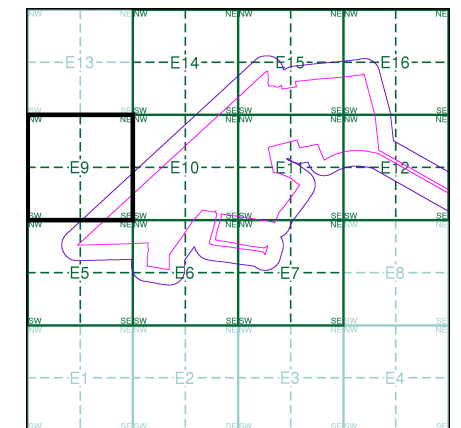

Order Details

Order Number: 298001007_1_1
 Customer Ref: 21-1098.04
 National Grid Reference: 483820, 381060
 Slice: E
 Site Area (Ha): 471.82
 Search Buffer (m): 100

Site Details

West Barton 1

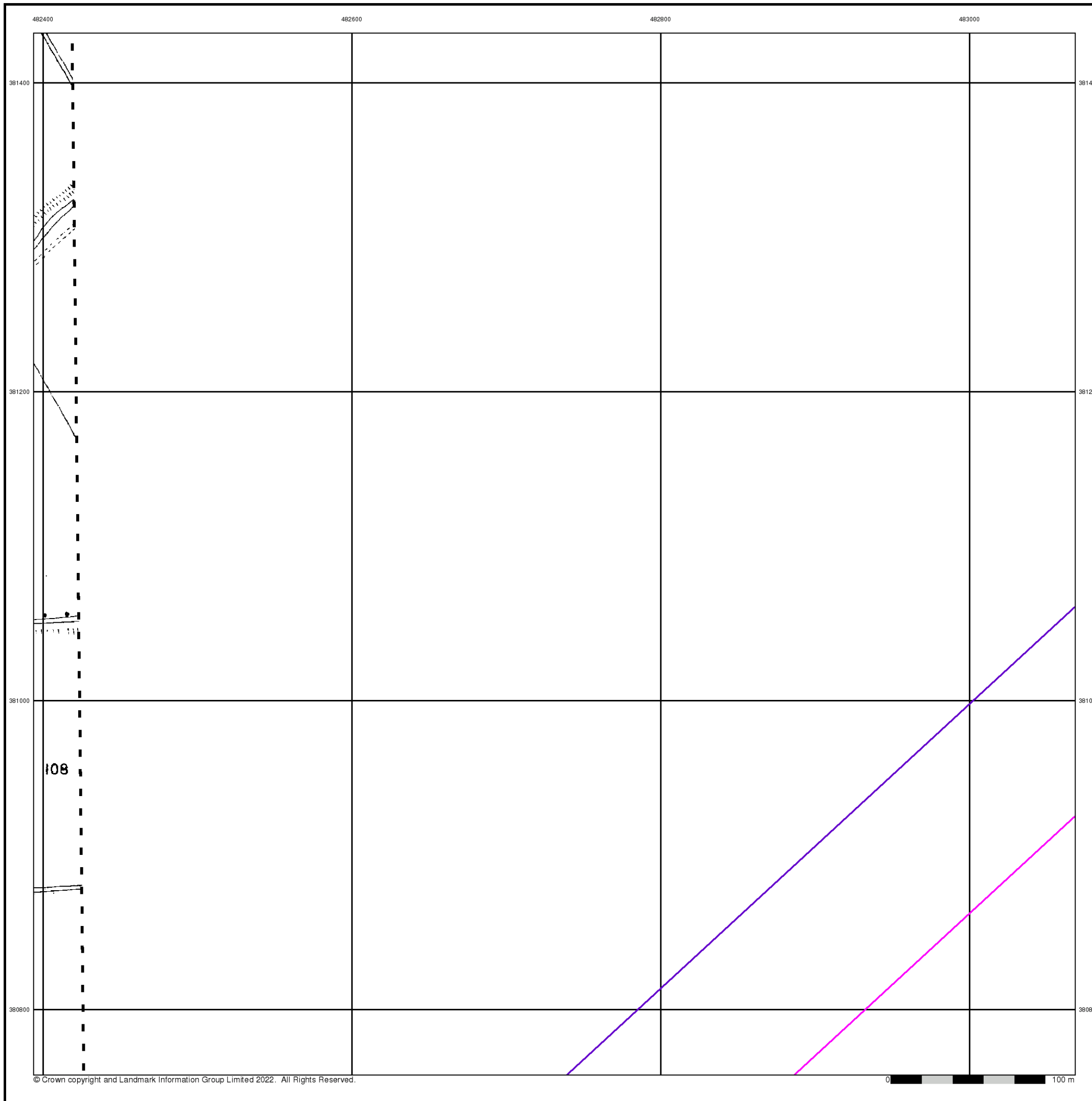

Nottinghamshire

Published 1899

Source map scale - 1:2,500

The historical maps shown were reproduced from maps predominantly held at the scale adopted for England, Wales and Scotland in the 1840's. In 1854 the 1:2,500 scale was adopted for mapping urban areas and by 1896 it covered the whole of what were considered to be the cultivated parts of Great Britain. The published date given below is often some years later than the surveyed date. Before 1938, all OS maps were based on the Cassini Projection, with independent surveys of a single county or group of counties, giving rise to significant inaccuracies in outlying areas.

Map Name(s) and Date(s)

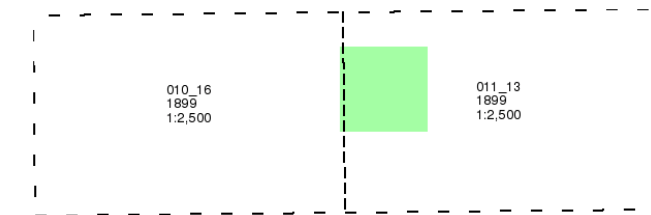

Historical Map - Segment E9

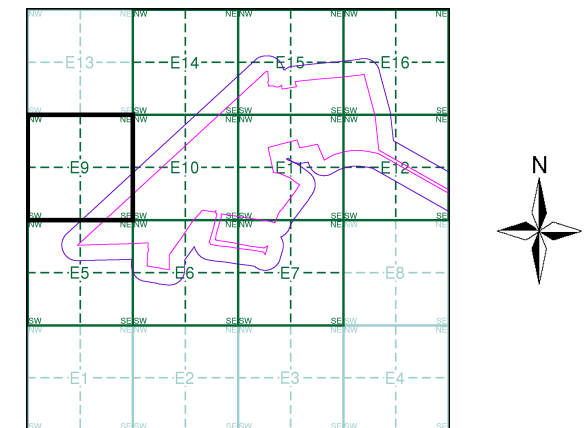

Order Details

Order Number: 298001007_1_1
 Customer Ref: 21-1098.04
 National Grid Reference: 483820, 381060
 Slice: E
 Site Area (Ha): 471.82
 Search Buffer (m): 100

Site Details

West Barton 1

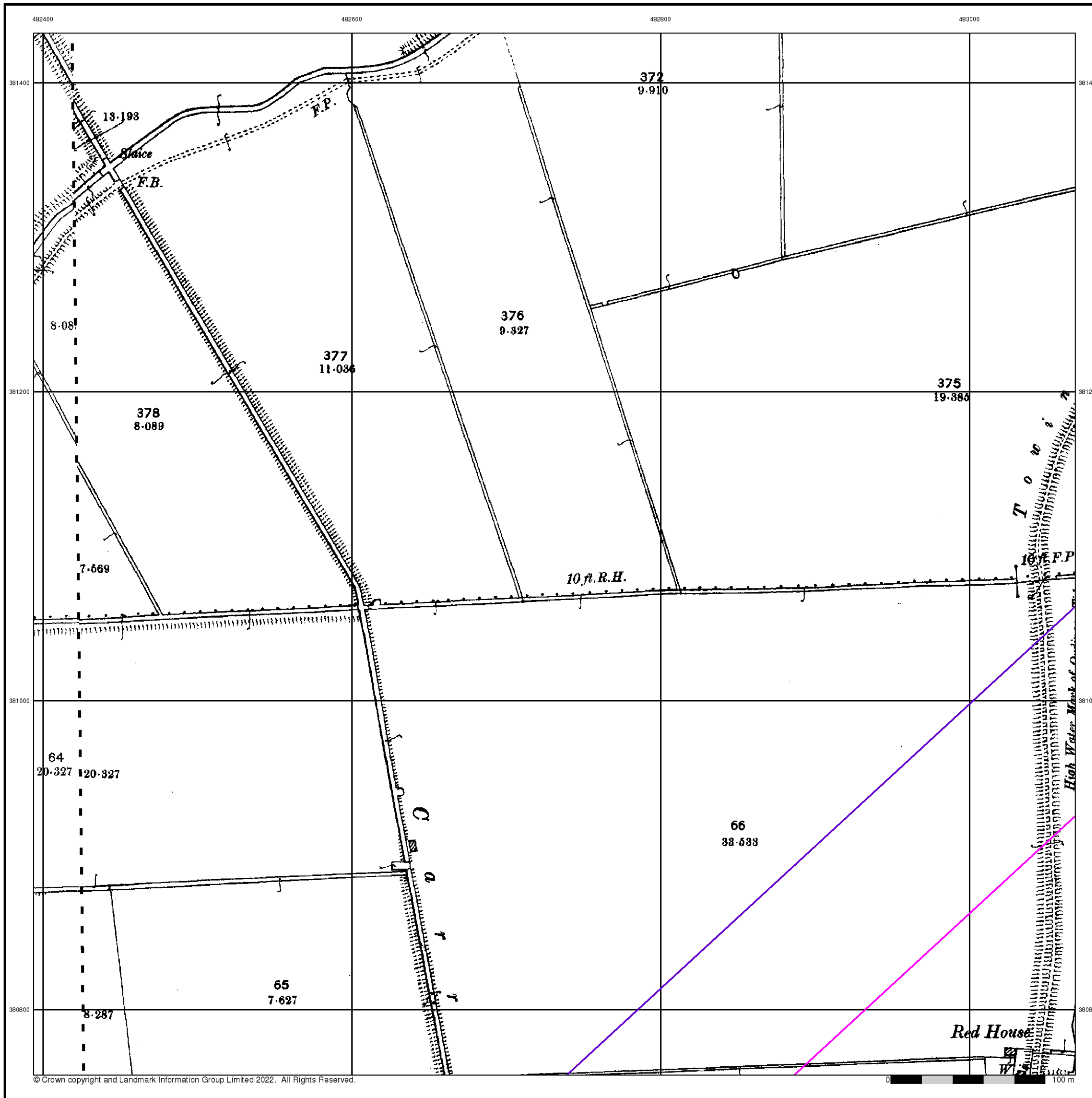

Lincolnshire

Published 1920

Source map scale - 1:2,500

The historical maps shown were reproduced from maps predominantly held at the scale adopted for England, Wales and Scotland in the 1840's. In 1854 the 1:2,500 scale was adopted for mapping urban areas and by 1896 it covered the whole of what were considered to be the cultivated parts of Great Britain. The published date given below is often some years later than the surveyed date. Before 1938, all OS maps were based on the Cassini Projection, with independent surveys of a single county or group of counties, giving rise to significant inaccuracies in outlying areas.

Map Name(s) and Date(s)

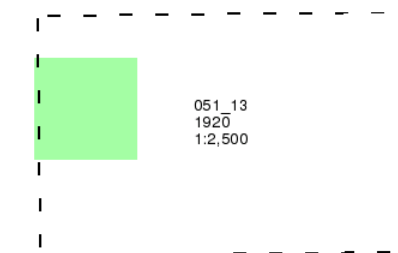

Historical Map - Segment E9

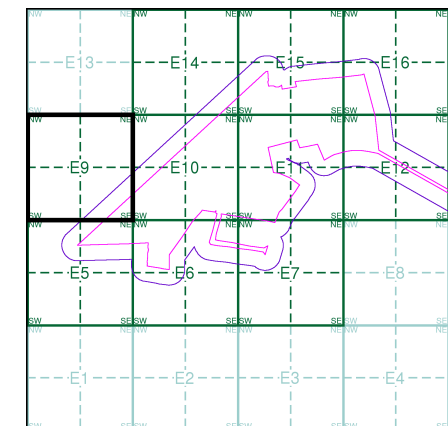

Order Details

Order Number: 298001007_1_1
 Customer Ref: 21-1098.04
 National Grid Reference: 483820, 381060
 Slice: E
 Site Area (Ha): 471.82
 Search Buffer (m): 100

Site Details

West Barton 1

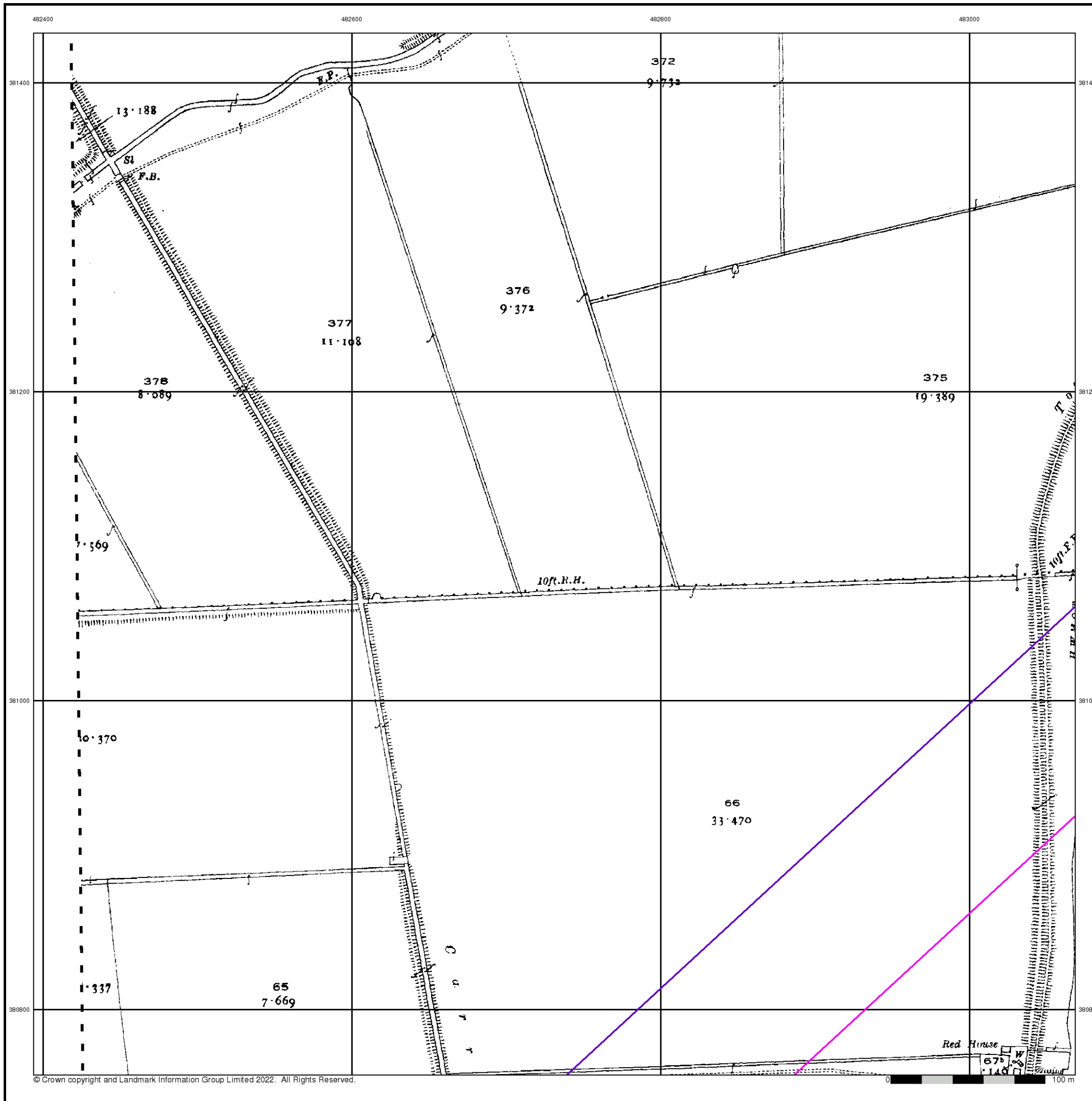

Nottinghamshire

Published 1920

Source map scale - 1:2,500

The historical maps shown were reproduced from maps predominantly held at the scale adopted for England, Wales and Scotland in the 1840's. In 1854 the 1:2,500 scale was adopted for mapping urban areas and by 1896 it covered the whole of what were considered to be the cultivated parts of Great Britain. The published date given below is often some years later than the surveyed date. Before 1938, all OS maps were based on the Cassini Projection, with independent surveys of a single county or group of counties, giving rise to significant inaccuracies in outlying areas.

Map Name(s) and Date(s)

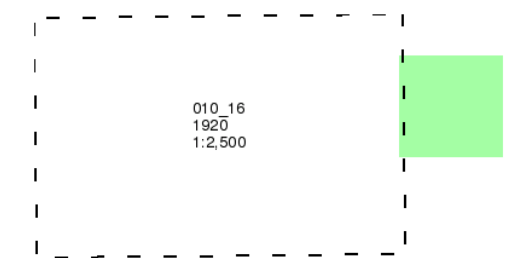

Historical Map - Segment E9

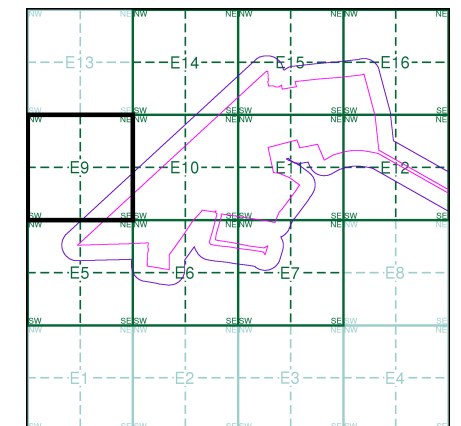

Order Details

Order Number: 298001007_1_1
 Customer Ref: 21-1098.04
 National Grid Reference: 483820, 381060
 Slice: E
 Site Area (Ha): 471.82
 Search Buffer (m): 100

Site Details

West Barton 1

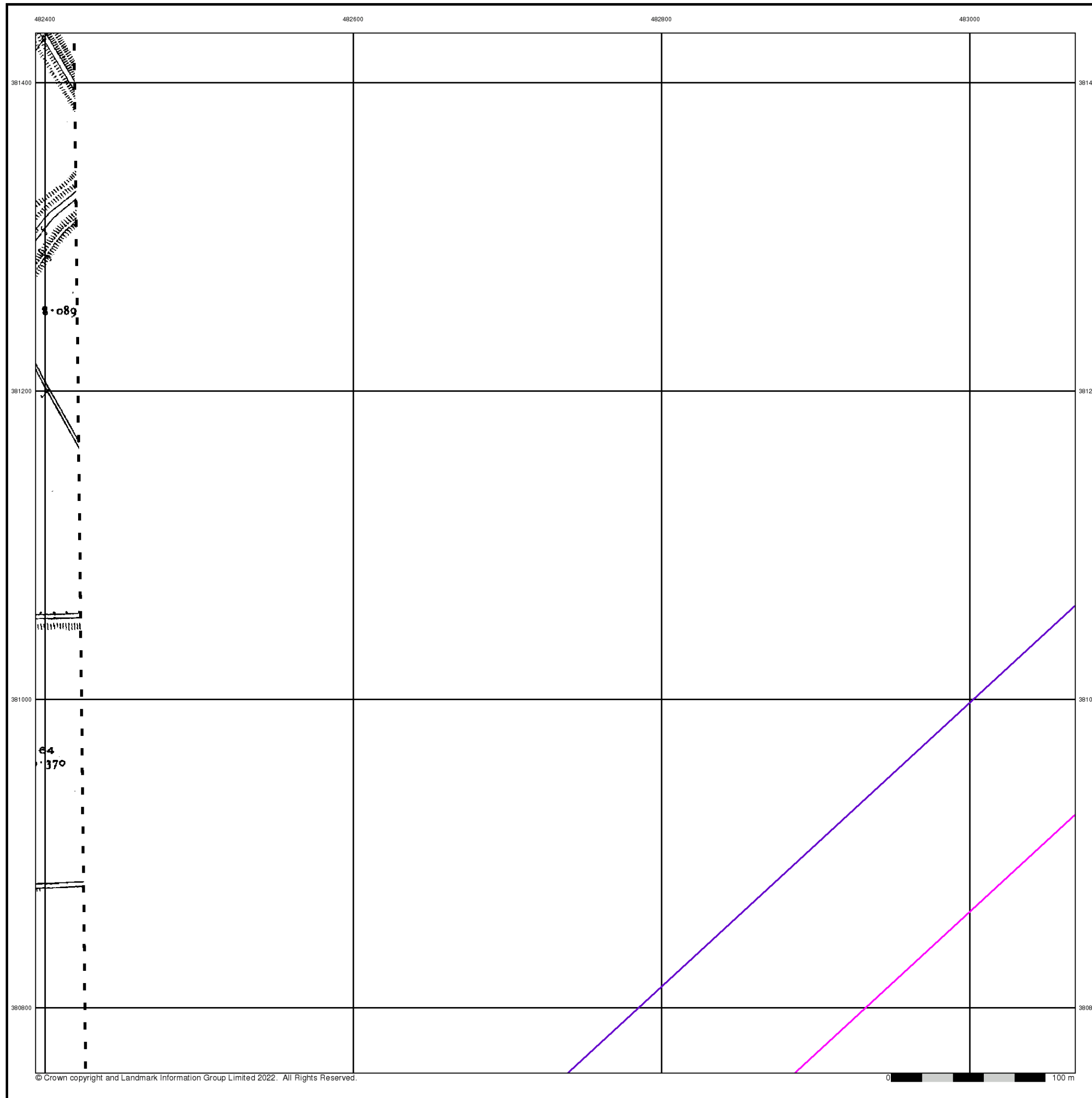

Ordnance Survey Plan
Published 1974 - 1975
Source map scale - 1:2,500

The historical maps shown were reproduced from maps predominantly held at the scale adopted for England, Wales and Scotland in the 1840's. In 1854 the 1:2,500 scale was adopted for mapping urban areas and by 1896 it covered the whole of what were considered to be the cultivated parts of Great Britain. The published date given below is often some years later than the surveyed date. Before 1938, all OS maps were based on the Cassini Projection, with independent surveys of a single county or group of counties, giving rise to significant inaccuracies in outlying areas.

Map Name(s) and Date(s)

SK8281 1975 1:2,500	SK8381 1975 1:2,500
SK8280 1974 1:2,500	SK8380 1974 1:2,500

Historical Map - Segment E9

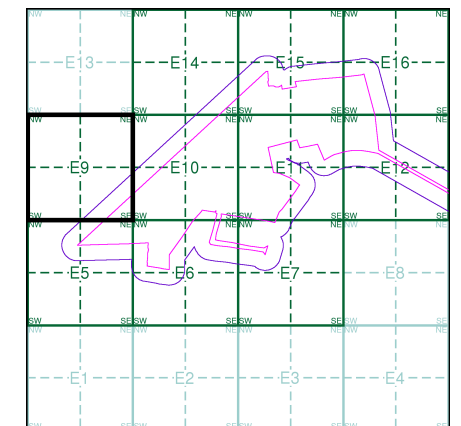

Order Details

Order Number: 298001007_1_1
 Customer Ref: 21-1098.04
 National Grid Reference: 483820, 381060
 Slice: E
 Site Area (Ha): 471.82
 Search Buffer (m): 100

Site Details

West Barton 1

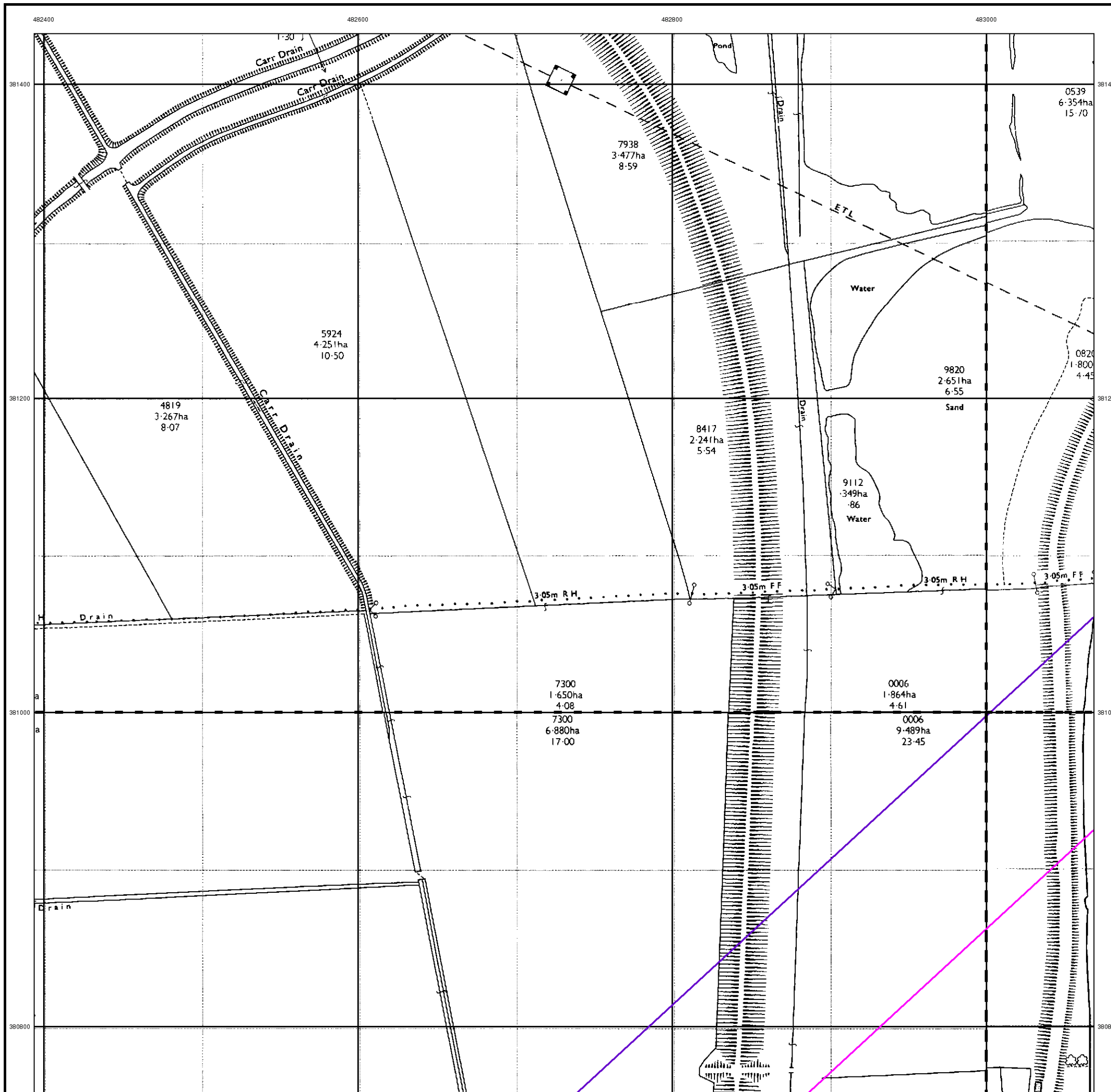

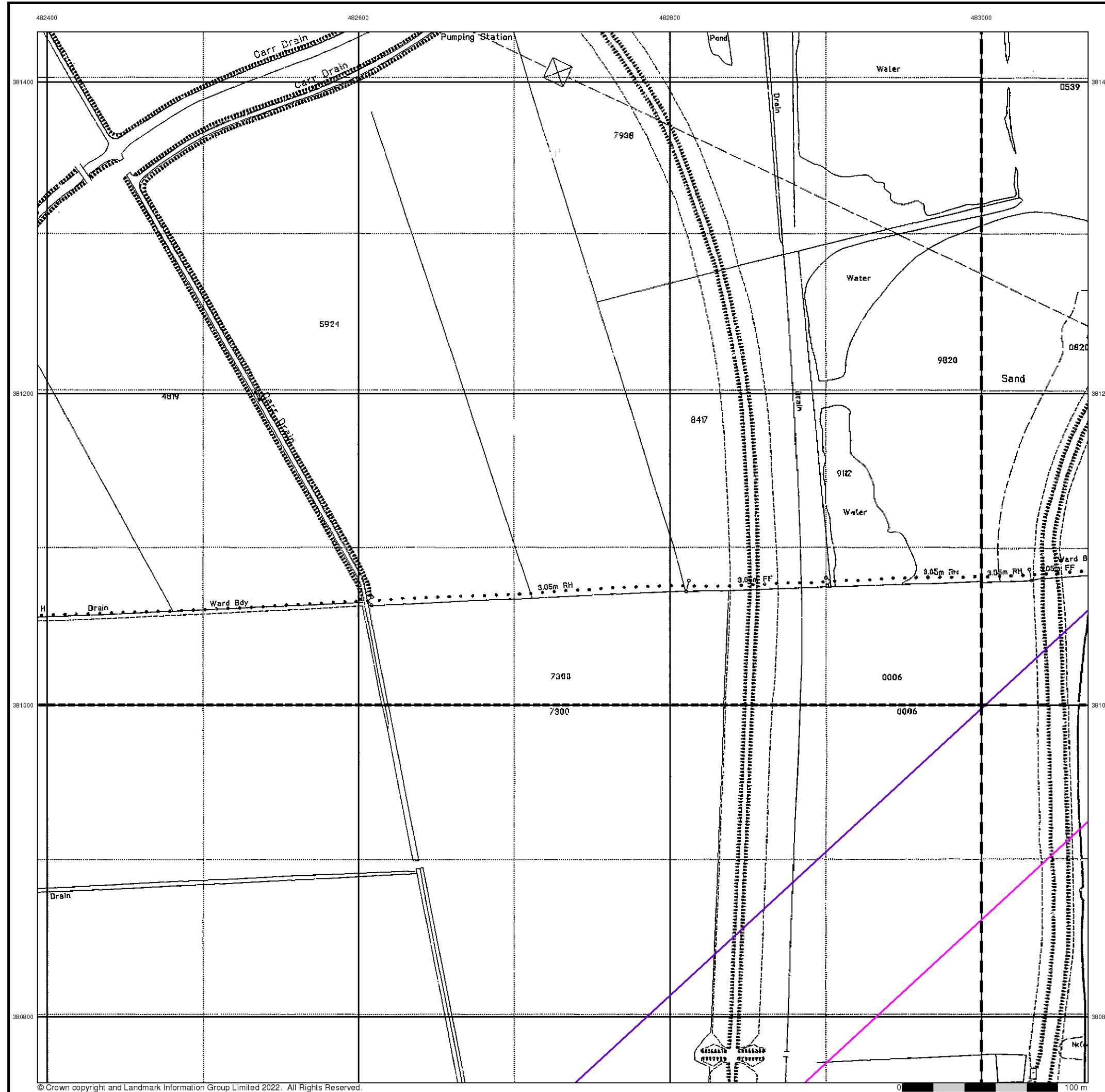

© Crown copyright and Landmark Information Group Limited 2022. All Rights Reserved.



Large-Scale National Grid Data
Published 1994
Source map scale - 1:2,500

'Large Scale National Grid Data' superseded SIM cards (Ordnance Survey's 'Survey of Information on Microfilm') in 1992, and continued to be produced until 1999. These maps were the fore-runners of digital mapping and so provide detailed information on houses and roads, but tend to show less topographic features such as vegetation. These maps were produced at both 1:2,500 and 1:1,250 scales.

Map Name(s) and Date(s)

SK8281 1994 1:2,500	SK8381 1994 1:2,500
SK8280 1994 1:2,500	SK8380 1994 1:2,500

Historical Map - Segment E9

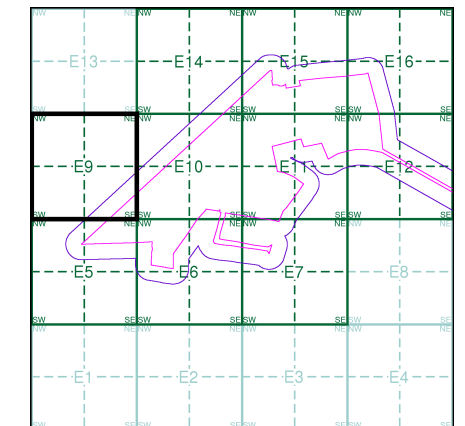

Order Details

Order Number: 298001007_1_1
 Customer Ref: 21-1098.04
 National Grid Reference: 483820, 381060
 Slice: E
 Site Area (Ha): 471.82
 Search Buffer (m): 100

Site Details

West Barton 1



Tel: 0844 844 9952
 Fax: 0844 844 9951
 Web: [REDACTED]

Historical Mapping Legends

Ordnance Survey County Series and Ordnance Survey Plan 1:2,500

Quarry, **Gravel Pit**, **Sand Pit**, **Clay Pit**, **Shingle**, **Refuse Heap**, **Sloping Masonry**, **Flat Rock**, **Marsh**, **Reeds**, **Osiers**, **Rough Pasture**, **Furze**, **Wood**, **Mixed Wood**, **Brushwood**, **Orchard**, **Fir**, **Ford**, **Stepping Stones**, **Ferry**, **Waterfall**, **Lock**, **Trig. Station**, **Altitude at Trig. Station**, **B.M. 325.9**, **Bench Mark**, **Surface Level**, **Arrow denotes flow of water**, **Antiquities (site of)**, **Cutting**, **Embankment**, **Railway crossing Road**, **Level Crossing**, **Road crossing Railway**, **Railway crossing River or Canal**, **Road over single stream**, **Road over River or Canal**, **County Boundary (Geographical)**, **County & Civil Parish Boundary**, **Administrative County & Civil Parish Boundary**, **County Borough Boundary (England)**, **Co. Boro. Bdy.**, **County Burgh Boundary (Scotland)**, **Co. Burgh Bdy.**, **B.P. B.S.** Boundary Post or Stone, **P.C.B.** Police Call Box, **B.R.** Bridle Road, **P.** Pump, **E.P.** Electricity Pylon, **S.P.** Signal Post, **F.B.** Foot Bridge, **SL** Sluice, **F.P.** Foot Path, **Sp.** Spring, **G.P.** Guide Post or Board, **T.C.B.** Telephone Call Box, **M.S.** Mile Stone, **Tr.** Trough, **M.P. M.R.** Mooring Post or Ring, **W.** Well

Ordnance Survey Plan, Additional SIMs and Supply of Unpublished Survey Information 1:2,500 and 1:1,250

Inactive Quarry, Chalk Pit or Clay Pit, **Active Quarry, Chalk Pit or Clay Pit**, **Rock**, **Boulders**, **Roofed Building**, **Glazed Roof Building**, **Sloping Masonry**, **Archway**, **Non-Coniferous Tree (surveyed)**, **Coniferous Tree (surveyed)**, **Non-Coniferous Trees (not surveyed)**, **Coniferous Trees (not surveyed)**, **Orchard Tree**, **Scrub**, **Bracken**, **Coppice, Osier**, **Reeds**, **Marsh, Saltings**, **Rough Grassland**, **Heath**, **Culvert**, **Direction of water flow**, **Bench Mark**, **Antiquity (site of)**, **Cave Entrance**, **Triangulation Station**, **Electricity Pylon**, **Electricity Transmission Line**, **County Boundary (Geographical)**, **County & Civil Parish Boundary**, **Civil Parish Boundary**, **Admin. County or County Bor. Boundary**, **L B Bdy** London Borough Boundary, **Symbol marking point where boundary mereing changes**, **BH** Beer House, **P** Pillar, Pole or Post, **BP, BS** Boundary Post or Stone, **PO** Post Office, **Cn, C** Capstan, Crane, **PC** Public Convenience, **Chy** Chimney, **PH** Public House, **D Fn** Drinking Fountain, **Pp** Pump, **EI P** Electricity Pillar or Post, **SB, S Br** Signal Box or Bridge, **FAP** Fire Alarm Pillar, **SP, SL** Signal Post or Light, **FB** Foot Bridge, **Spr** Spring, **GP** Guide Post, **Tk** Tank or Track, **H** Hydrant or Hydraulic, **TCB** Telephone Call Box, **LC** Level Crossing, **TCP** Telephone Call Post, **MH** Manhole, **Tr** Trough, **MP** Mile Post or Mooring Post, **Wr Pt, Wr T** Water Point, Water Tap, **MS** Mile Stone, **W** Well, **NTL** Normal Tidal Limit, **Wd Pp** Wind Pump

Large-Scale National Grid Data 1:2,500 and 1:1,250

Cliff, **Slopes**, **Top**, **Rock**, **Rock (scattered)**, **Boulders**, **Boulders (scattered)**, **Positioned Boulder**, **Scree**, **Non-Coniferous Tree (surveyed)**, **Coniferous Tree (surveyed)**, **Non-Coniferous Trees (not surveyed)**, **Coniferous Trees (not surveyed)**, **Orchard Tree**, **Scrub**, **Bracken**, **Coppice, Osier**, **Reeds**, **Marsh, Saltings**, **Rough Grassland**, **Heath**, **Culvert**, **Direction of water flow**, **Triangulation Station**, **Antiquity (site of)**, **Electricity Transmission Line**, **Electricity Pylon**, **BM 231.60m** Bench Mark, **Buildings with Building Seed**, **Roofed Building**, **Glazed Roof Building**, **Civil parish/community boundary**, **District boundary**, **County boundary**, **Boundary post/stone**, **Boundary mereing symbol (note: these always appear in opposed pairs or groups of three)**, **Bks** Barracks, **P** Pillar, Pole or Post, **Bty** Battery, **PO** Post Office, **Cemy** Cemetery, **PC** Public Convenience, **Chy** Chimney, **Pp** Pump, **Cis** Cistern, **Ppg Sta** Pumping Station, **Dismtd Rly** Dismantled Railway, **PW** Place of Worship, **EI Gen Sta** Electricity Generating Station, **Sewage Ppg Sta** Sewage Pumping Station, **EI P** Electricity Pole, Pillar, **SB, S Br** Signal Box or Bridge, **EI Sub Sta** Electricity Sub Station, **SP, SL** Signal Post or Light, **FB** Filter Bed, **Spr** Spring, **Fn / D Fn** Fountain / Drinking Ftn., **Tk** Tank or Track, **Gas Gov** Gas Valve Compound, **Tr** Trough, **GVC** Gas Governor, **Wd Pp** Wind Pump, **GP** Guide Post, **Wr Pt, Wr T** Water Point, Water Tap, **MH** Manhole, **Wks** Works (building or area), **MP, MS** Mile Post or Mile Stone, **W** Well



Historical Mapping & Photography included:

Mapping Type	Scale	Date	Pg
Lincolnshire	1:2,500	1886	2
Nottinghamshire	1:2,500	1899	3
Lincolnshire	1:2,500	1920	4
Ordnance Survey Plan	1:2,500	1974 - 1975	5
Large-Scale National Grid Data	1:2,500	1994	6

Historical Map - Segment E10

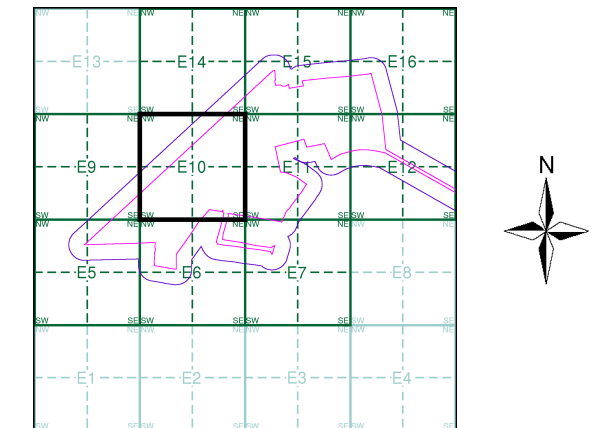

Order Details

Order Number: 298001007_1_1
 Customer Ref: 21-1098.04
 National Grid Reference: 483820, 381060
 Slice: E
 Site Area (Ha): 471.82
 Search Buffer (m): 100

Site Details

West Barton 1



Tel: 0844 844 9952
 Fax: 0844 844 9951
 Web: [REDACTED]

Lincolnshire

Published 1886

Source map scale - 1:2,500

The historical maps shown were reproduced from maps predominantly held at the scale adopted for England, Wales and Scotland in the 1840's. In 1854 the 1:2,500 scale was adopted for mapping urban areas and by 1896 it covered the whole of what were considered to be the cultivated parts of Great Britain. The published date given below is often some years later than the surveyed date. Before 1938, all OS maps were based on the Cassini Projection, with independent surveys of a single county or group of counties, giving rise to significant inaccuracies in outlying areas.

Map Name(s) and Date(s)

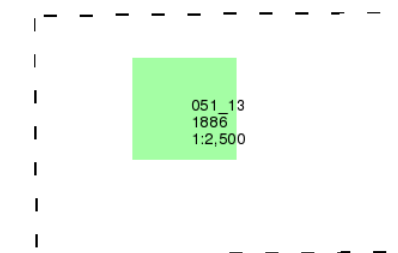

Historical Map - Segment E10

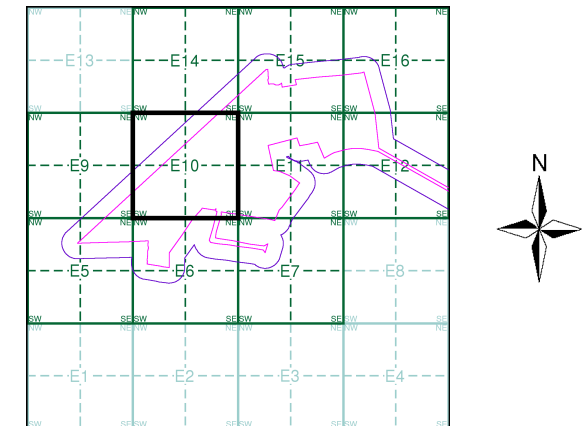

Order Details

Order Number: 298001007_1_1
 Customer Ref: 21-1098.04
 National Grid Reference: 483820, 381060
 Slice: E
 Site Area (Ha): 471.82
 Search Buffer (m): 100

Site Details

West Barton 1

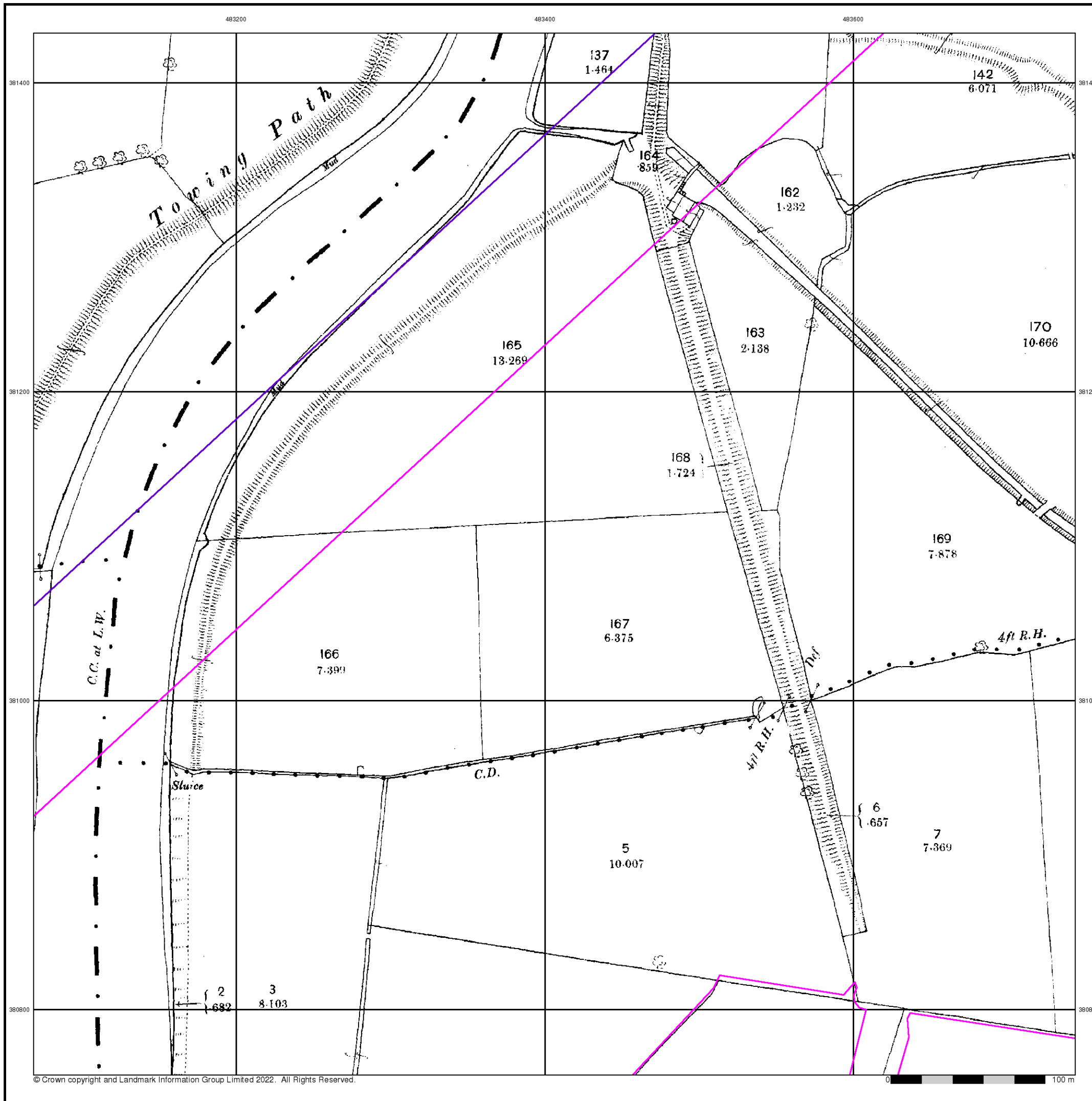

Nottinghamshire

Published 1899

Source map scale - 1:2,500

The historical maps shown were reproduced from maps predominantly held at the scale adopted for England, Wales and Scotland in the 1840's. In 1854 the 1:2,500 scale was adopted for mapping urban areas and by 1896 it covered the whole of what were considered to be the cultivated parts of Great Britain. The published date given below is often some years later than the surveyed date. Before 1938, all OS maps were based on the Cassini Projection, with independent surveys of a single county or group of counties, giving rise to significant inaccuracies in outlying areas.

Map Name(s) and Date(s)

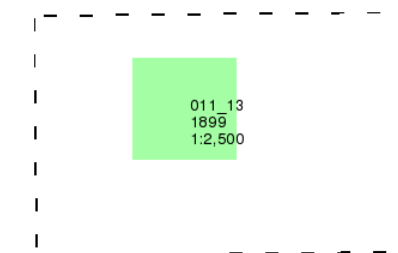

Historical Map - Segment E10

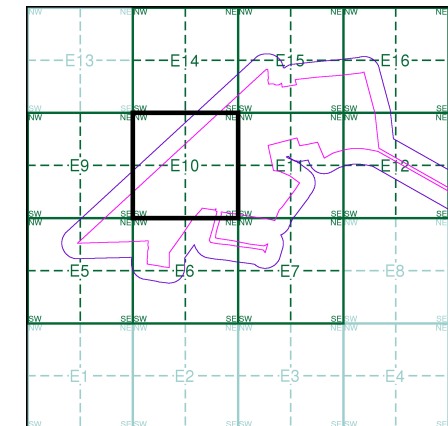

Order Details

Order Number: 298001007_1_1
 Customer Ref: 21-1098.04
 National Grid Reference: 483820, 381060
 Slice: E
 Site Area (Ha): 471.82
 Search Buffer (m): 100

Site Details

West Barton 1

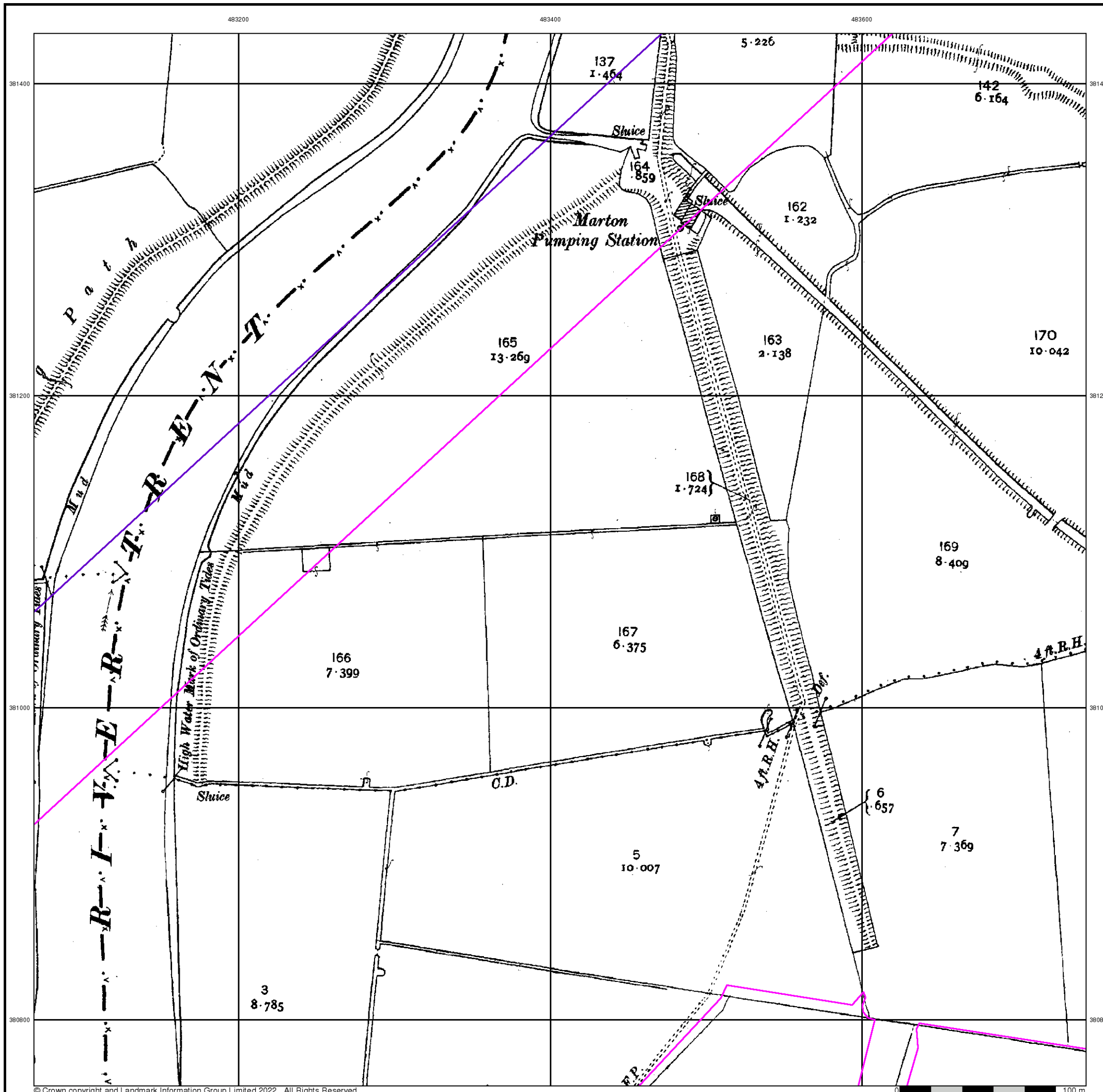

Lincolnshire

Published 1920

Source map scale - 1:2,500

The historical maps shown were reproduced from maps predominantly held at the scale adopted for England, Wales and Scotland in the 1840's. In 1854 the 1:2,500 scale was adopted for mapping urban areas and by 1896 it covered the whole of what were considered to be the cultivated parts of Great Britain. The published date given below is often some years later than the surveyed date. Before 1938, all OS maps were based on the Cassini Projection, with independent surveys of a single county or group of counties, giving rise to significant inaccuracies in outlying areas.

Map Name(s) and Date(s)

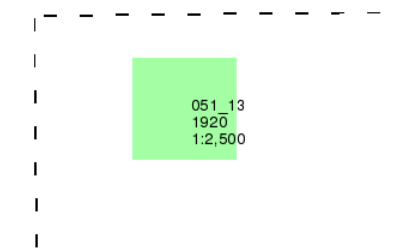

Historical Map - Segment E10

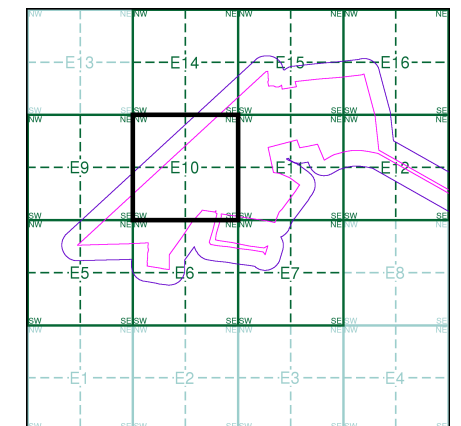

Order Details

Order Number: 298001007_1_1
 Customer Ref: 21-1098.04
 National Grid Reference: 483820, 381060
 Slice: E
 Site Area (Ha): 471.82
 Search Buffer (m): 100

Site Details

West Barton 1

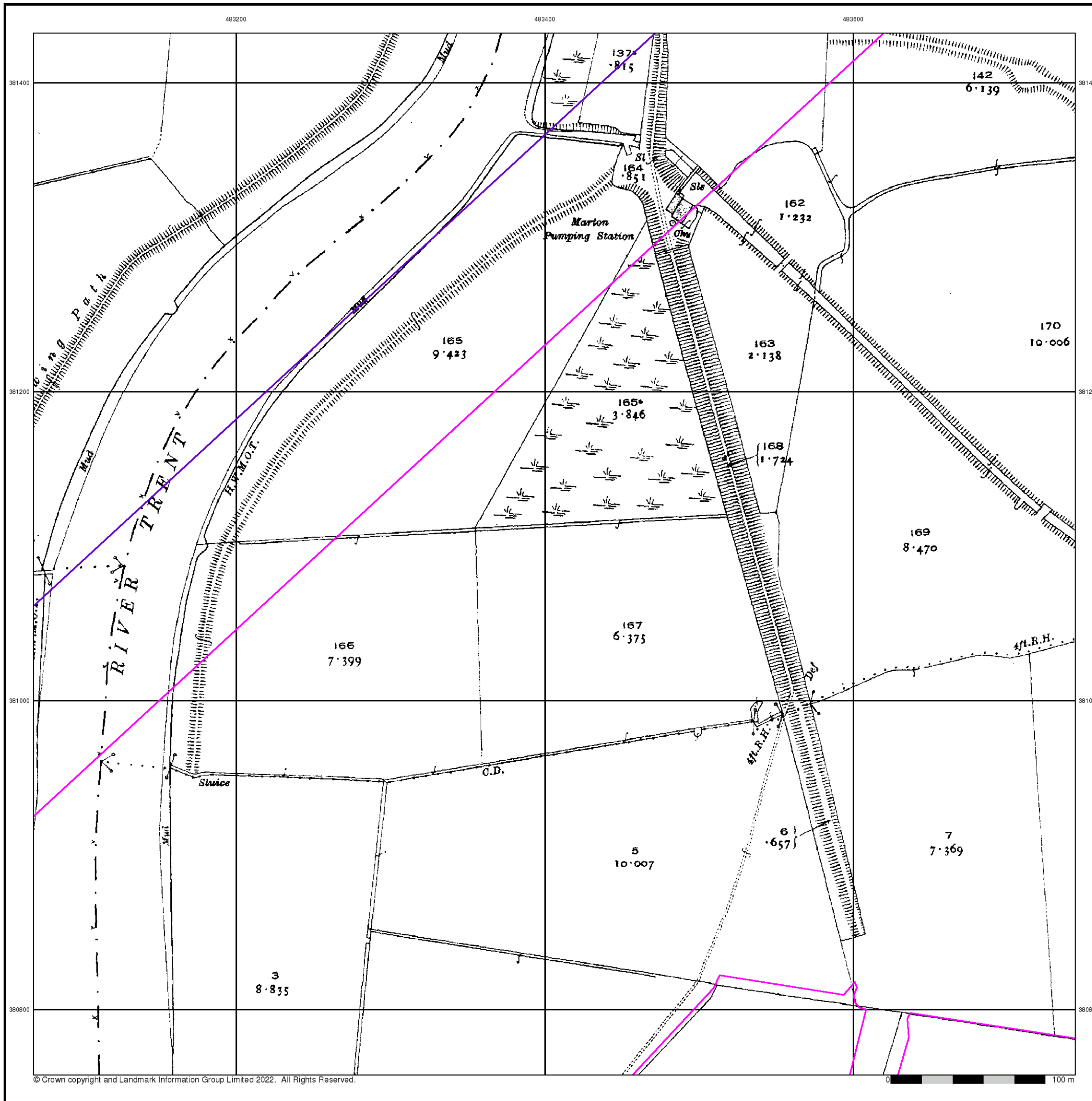

Ordnance Survey Plan
Published 1974 - 1975
Source map scale - 1:2,500

The historical maps shown were reproduced from maps predominantly held at the scale adopted for England, Wales and Scotland in the 1840's. In 1854 the 1:2,500 scale was adopted for mapping urban areas and by 1896 it covered the whole of what were considered to be the cultivated parts of Great Britain. The published date given below is often some years later than the surveyed date. Before 1938, all OS maps were based on the Cassini Projection, with independent surveys of a single county or group of counties, giving rise to significant inaccuracies in outlying areas.

Map Name(s) and Date(s)

SK8381	1975	1:2,500
SK8380	1974	1:2,500

Historical Map - Segment E10

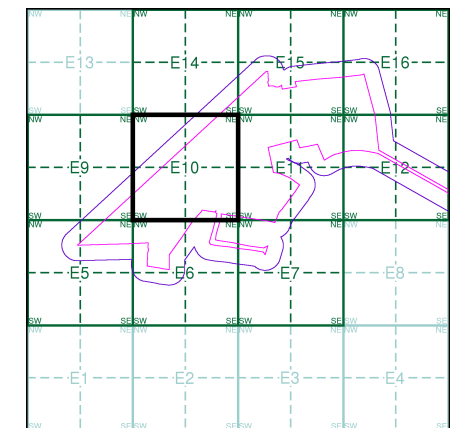

Order Details

Order Number: 298001007_1_1
 Customer Ref: 21-1098.04
 National Grid Reference: 483820, 381060
 Slice: E
 Site Area (Ha): 471.82
 Search Buffer (m): 100

Site Details

West Barton 1

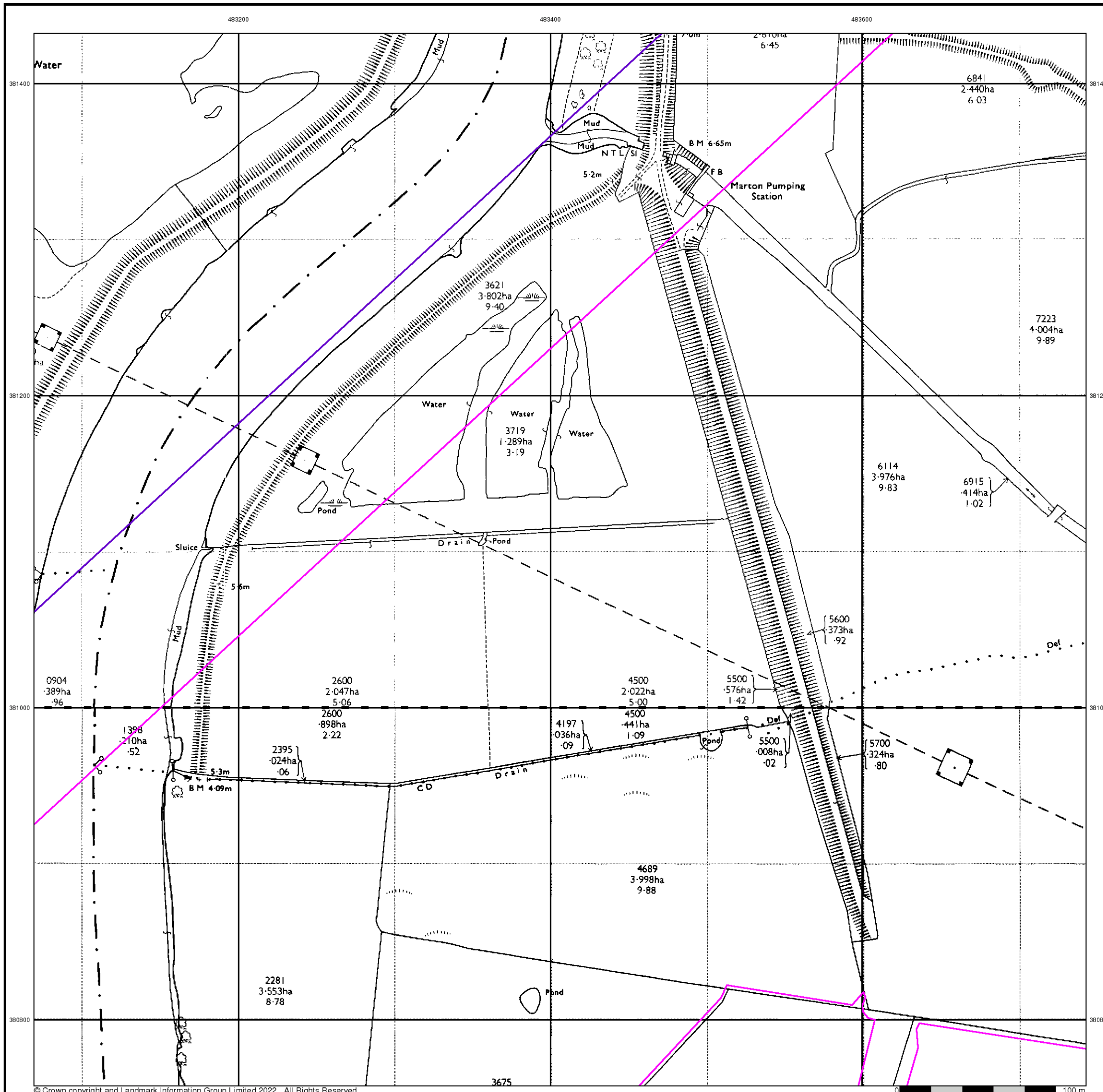

Large-Scale National Grid Data

Published 1994

Source map scale - 1:2,500

'Large Scale National Grid Data' superseded SIM cards (Ordnance Survey's 'Survey of Information on Microfilm') in 1992, and continued to be produced until 1999. These maps were the fore-runners of digital mapping and so provide detailed information on houses and roads, but tend to show less topographic features such as vegetation. These maps were produced at both 1:2,500 and 1:1,250 scales.

Map Name(s) and Date(s)

SK8381	1994	1:2,500
SK8380	1994	1:2,500

Historical Map - Segment E10

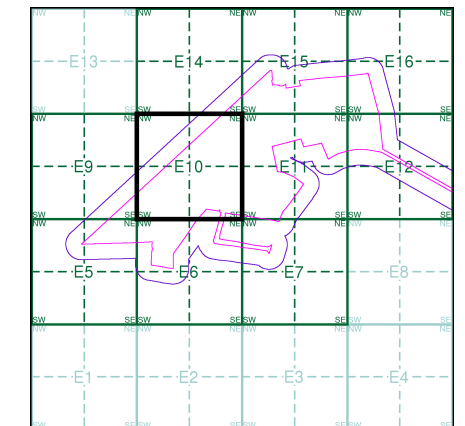

Order Details

Order Number: 298001007_1_1
 Customer Ref: 21-1098.04
 National Grid Reference: 483820, 381060
 Slice: E
 Site Area (Ha): 471.82
 Search Buffer (m): 100

Site Details

West Barton 1

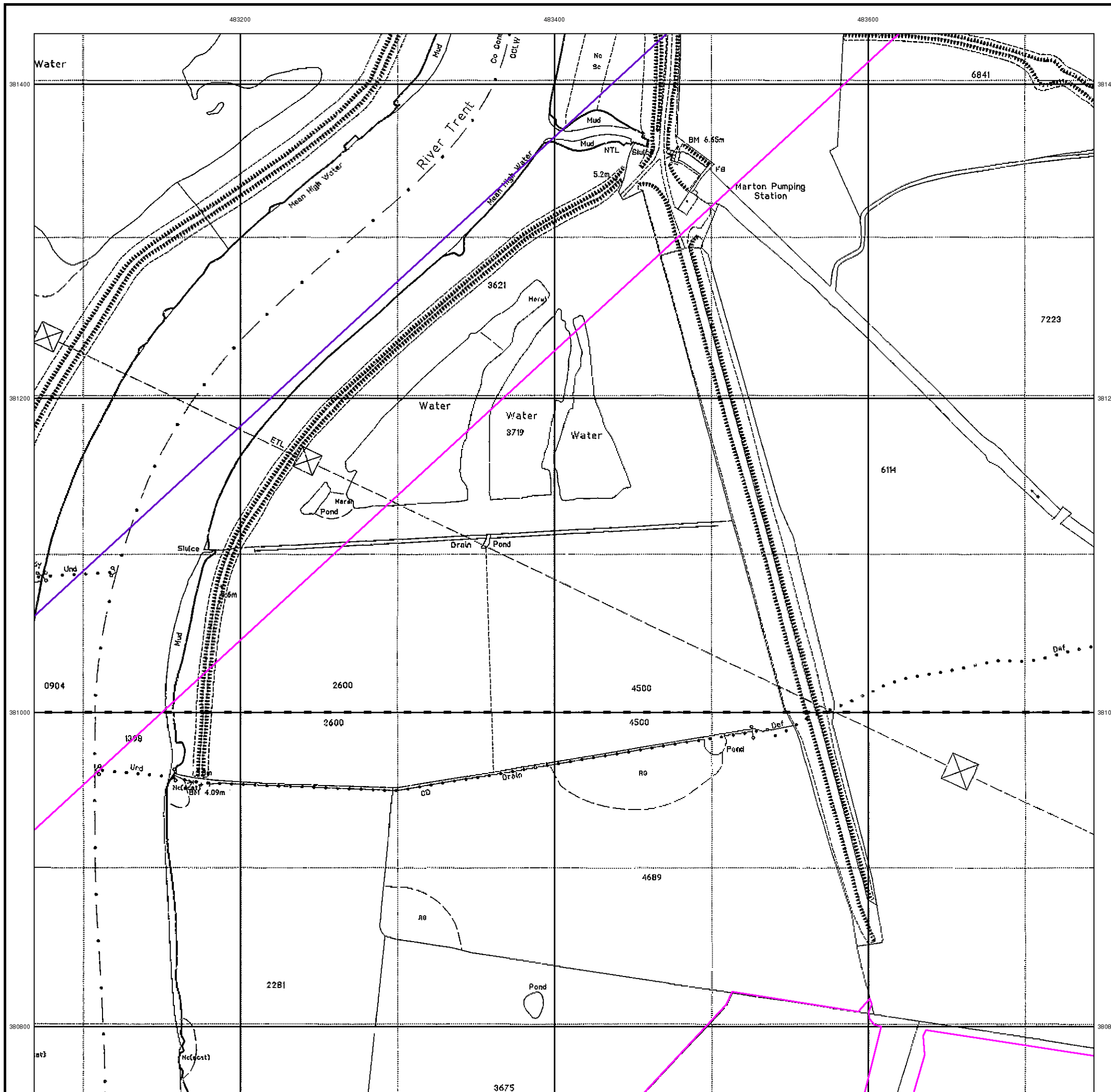

Historical Mapping Legends

Ordnance Survey County Series and Ordnance Survey Plan 1:2,500

Quarry **Gravel Pit** **Sand Pit**
Clay Pit **Shingle** **Refuse Heap**
Sloping Masonry **Flat Rock**
Marsh **Reeds** **Osiers**
Rough Pasture **Furze** **Wood**
Mixed Wood **Brushwood** **Orchard**
Fir **Ford** **Stepping Stones**
Ferry **Waterfall** **Lock**
Trig. Station **Altitude at Trig. Station**
B.M. 325.9 **Bench Mark** **Surface Level**
Arrow denotes flow of water **Antiquities (site of)**
Cutting **Embankment**
Railway crossing Road **Level Crossing** **Road crossing Railway**
Railway crossing River or Canal **Road over single stream** **Road over River or Canal**
County Boundary (Geographical)
County & Civil Parish Boundary
Administrative County & Civil Parish Boundary
County Borough Boundary (England)
County Burgh Boundary (Scotland)
Boundary Post or Stone **Police Call Box**
B.R. Bridle Road **Pump**
E.P. Electricity Pylon **S.P. Signal Post**
F.B. Foot Bridge **Sl. Sluice**
F.P. Foot Path **Sp. Spring**
G.P. Guide Post or Board **T.C.B. Telephone Call Box**
M.S. Mile Stone **Tr. Trough**
M.P. M.R. Mooring Post or Ring **W. Well**

Ordnance Survey Plan, Additional SIMs and Supply of Unpublished Survey Information 1:2,500 and 1:1,250

Inactive Quarry, Chalk Pit or Clay Pit **Active Quarry, Chalk Pit or Clay Pit**
Rock **Boulders**
Cliff **Slopes** **Top**
Roofed Building **Glazed Roof Building**
Sloping Masonry **Archway**
Non-Coniferous Tree (surveyed) **Coniferous Tree (surveyed)**
Non-Coniferous Trees (not surveyed) **Coniferous Trees (not surveyed)**
Orchard Tree **Scrub** **Bracken**
Coppice, Osier **Reeds** **Marsh, Saltings**
Rough Grassland **Heath** **Culvert**
Direction of water flow **Bench Mark** **Antiquity (site of)**
Cave Entrance **Triangulation Station** **Electricity Pylon**
Electricity Transmission Line
County Boundary (Geographical)
County & Civil Parish Boundary
Civil Parish Boundary
Admin. County or County Bor. Boundary
London Borough Boundary
Symbol marking point where boundary mereing changes
BH Beer House **P Pillar, Pole or Post**
BP, BS Boundary Post or Stone **PO Post Office**
Cn, C Capstan, Crane **PC Public Convenience**
Chy Chimney **PH Public House**
D Fn Drinking Fountain **Pp Pump**
EI P Electricity Pillar or Post **SB, S Br Signal Box or Bridge**
FAP Fire Alarm Pillar **SP, SL Signal Post or Light**
FB Foot Bridge **Spr Spring**
GP Guide Post **Tk Tank or Track**
H Hydrant or Hydraulic **TCB Telephone Call Box**
LC Level Crossing **TCP Telephone Call Post**
MH Manhole **Tr Trough**
MP Mile Post or Mooring Post **Wr Pt, Wr T Water Point, Water Tap**
MS Mile Stone **W Well**
NTL Normal Tidal Limit **Wd Pp Wind Pump**

Large-Scale National Grid Data 1:2,500 and 1:1,250

Cliff **Slopes** **Top**
Rock **Rock (scattered)**
Boulders **Boulders (scattered)**
Positioned Boulder **Scree**
Non-Coniferous Tree (surveyed) **Coniferous Tree (surveyed)**
Non-Coniferous Trees (not surveyed) **Coniferous Trees (not surveyed)**
Orchard Tree **Scrub** **Bracken**
Coppice, Osier **Reeds** **Marsh, Saltings**
Rough Grassland **Heath** **Culvert**
Direction of water flow **Triangulation Station** **Antiquity (site of)**
Electricity Transmission Line **Electricity Pylon**
Bench Mark **Buildings with Building Seed**
Roofed Building **Glazed Roof Building**
Civil parish/community boundary
District boundary
County boundary
Boundary post/stone
Boundary mereing symbol (note: these always appear in opposed pairs or groups of three)
Bks Barracks **P Pillar, Pole or Post**
Bty Battery **PO Post Office**
Cemy Cemetery **PC Public Convenience**
Chy Chimney **Pp Pump**
Cis Cistern **Ppg Sta Pumping Station**
Dismtd Rly Dismantled Railway **PW Place of Worship**
EI Gen Sta Electricity Generating Station **Sewage Ppg Sta Sewage Pumping Station**
EI P Electricity Pole, Pillar **SB, S Br Signal Box or Bridge**
EI Sub Sta Electricity Sub Station **SP, SL Signal Post or Light**
FB Filter Bed **Spr Spring**
Fn / D Fn Fountain / Drinking Ftn. **Tk Tank or Track**
Gas Gov Gas Valve Compound **Tr Trough**
GVC Gas Governor **Wd Pp Wind Pump**
GP Guide Post **Wr Pt, Wr T Water Point, Water Tap**
MH Manhole **Wks Works (building or area)**
MP, MS Mile Post or Mile Stone **W Well**



Historical Mapping & Photography included:

Mapping Type	Scale	Date	Pg
Lincolnshire	1:2,500	1886	2
Nottinghamshire	1:2,500	1899	3
Lincolnshire	1:2,500	1920	4
Ordnance Survey Plan	1:2,500	1974 - 1975	5
Additional SIMs	1:2,500	1993	6
Large-Scale National Grid Data	1:2,500	1994	7

Historical Map - Segment E11

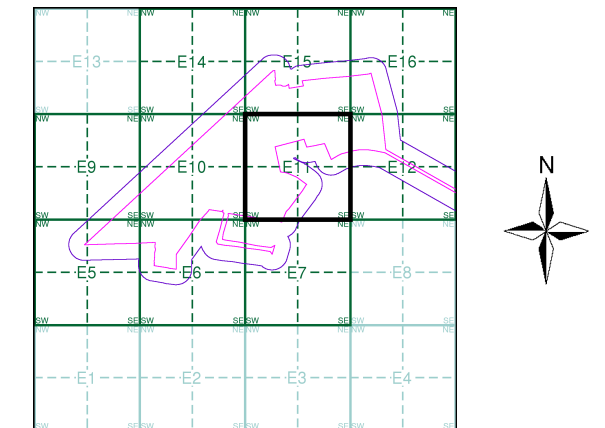

Order Details

Order Number: 298001007_1_1
 Customer Ref: 21-1098.04
 National Grid Reference: 483820, 381060
 Slice: E
 Site Area (Ha): 471.82
 Search Buffer (m): 100

Site Details

West Barton 1



Tel: 0844 844 9952
 Fax: 0844 844 9951
 Web: [REDACTED]

Lincolnshire

Published 1886

Source map scale - 1:2,500

The historical maps shown were reproduced from maps predominantly held at the scale adopted for England, Wales and Scotland in the 1840's. In 1854 the 1:2,500 scale was adopted for mapping urban areas and by 1896 it covered the whole of what were considered to be the cultivated parts of Great Britain. The published date given below is often some years later than the surveyed date. Before 1938, all OS maps were based on the Cassini Projection, with independent surveys of a single county or group of counties, giving rise to significant inaccuracies in outlying areas.

Map Name(s) and Date(s)

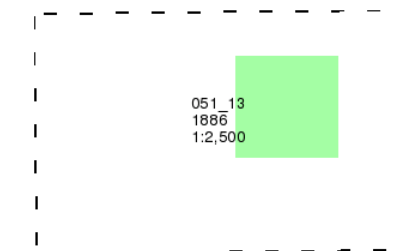

Historical Map - Segment E11

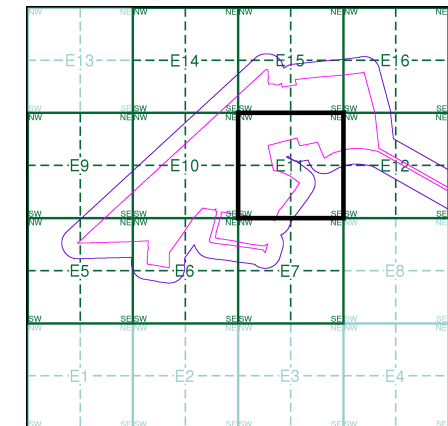

Order Details

Order Number: 298001007_1_1
 Customer Ref: 21-1098.04
 National Grid Reference: 483820, 381060
 Slice: E
 Site Area (Ha): 471.82
 Search Buffer (m): 100

Site Details

West Barton 1

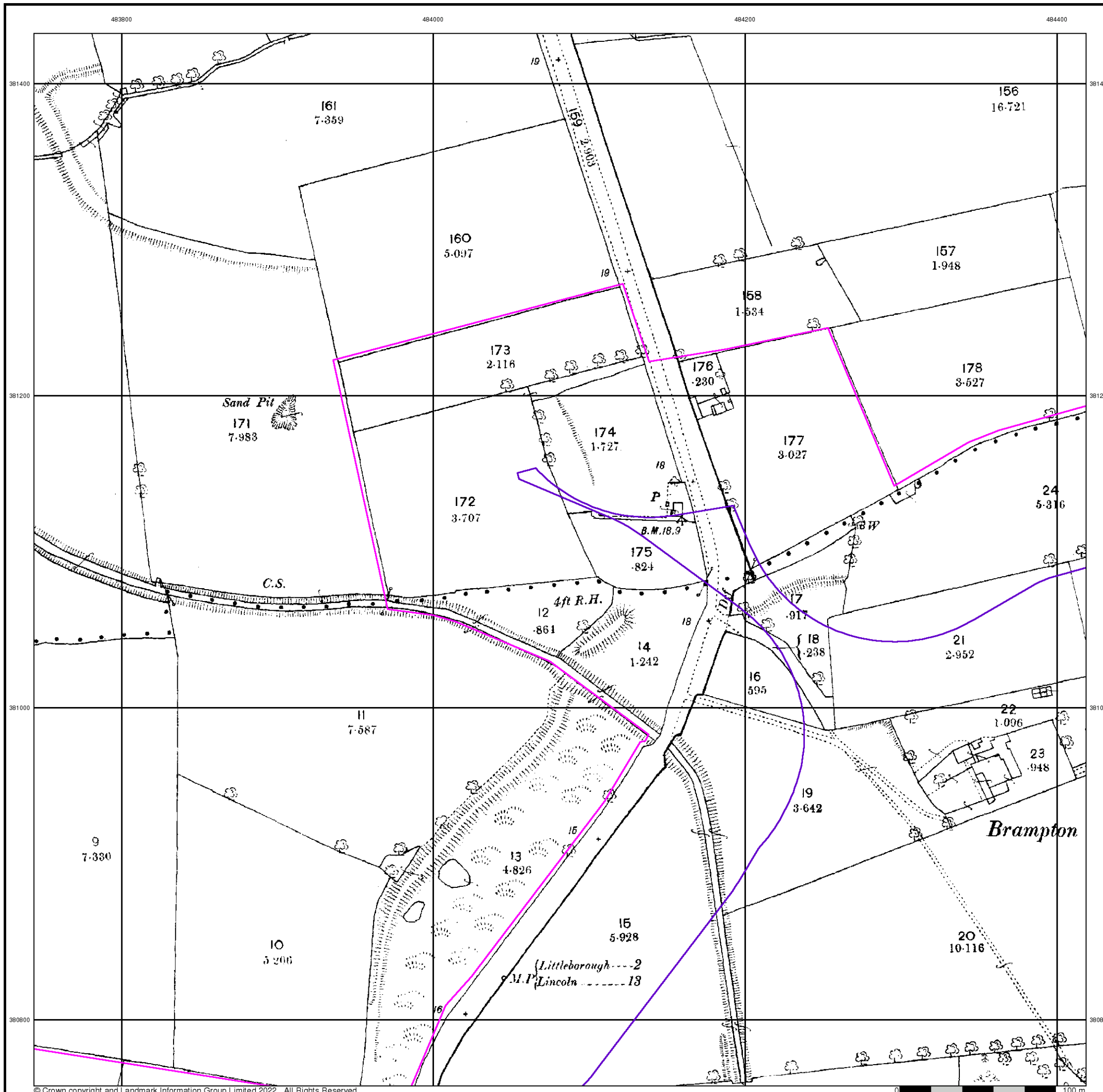

Nottinghamshire

Published 1899

Source map scale - 1:2,500

The historical maps shown were reproduced from maps predominantly held at the scale adopted for England, Wales and Scotland in the 1840's. In 1854 the 1:2,500 scale was adopted for mapping urban areas and by 1896 it covered the whole of what were considered to be the cultivated parts of Great Britain. The published date given below is often some years later than the surveyed date. Before 1938, all OS maps were based on the Cassini Projection, with independent surveys of a single county or group of counties, giving rise to significant inaccuracies in outlying areas.

Map Name(s) and Date(s)

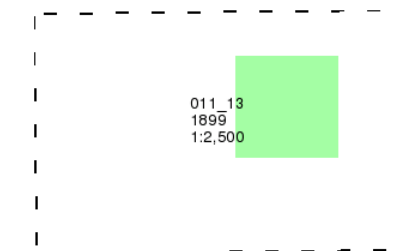

Historical Map - Segment E11

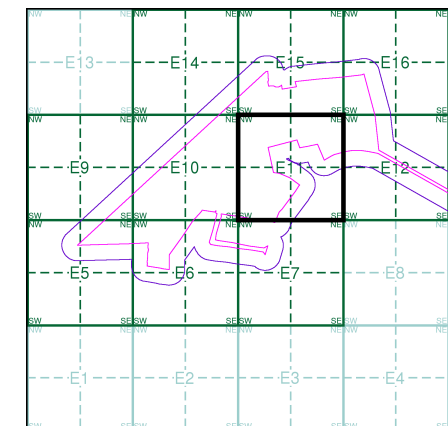

Order Details

Order Number: 298001007_1_1
 Customer Ref: 21-1098.04
 National Grid Reference: 483820, 381060
 Slice: E
 Site Area (Ha): 471.82
 Search Buffer (m): 100

Site Details

West Barton 1

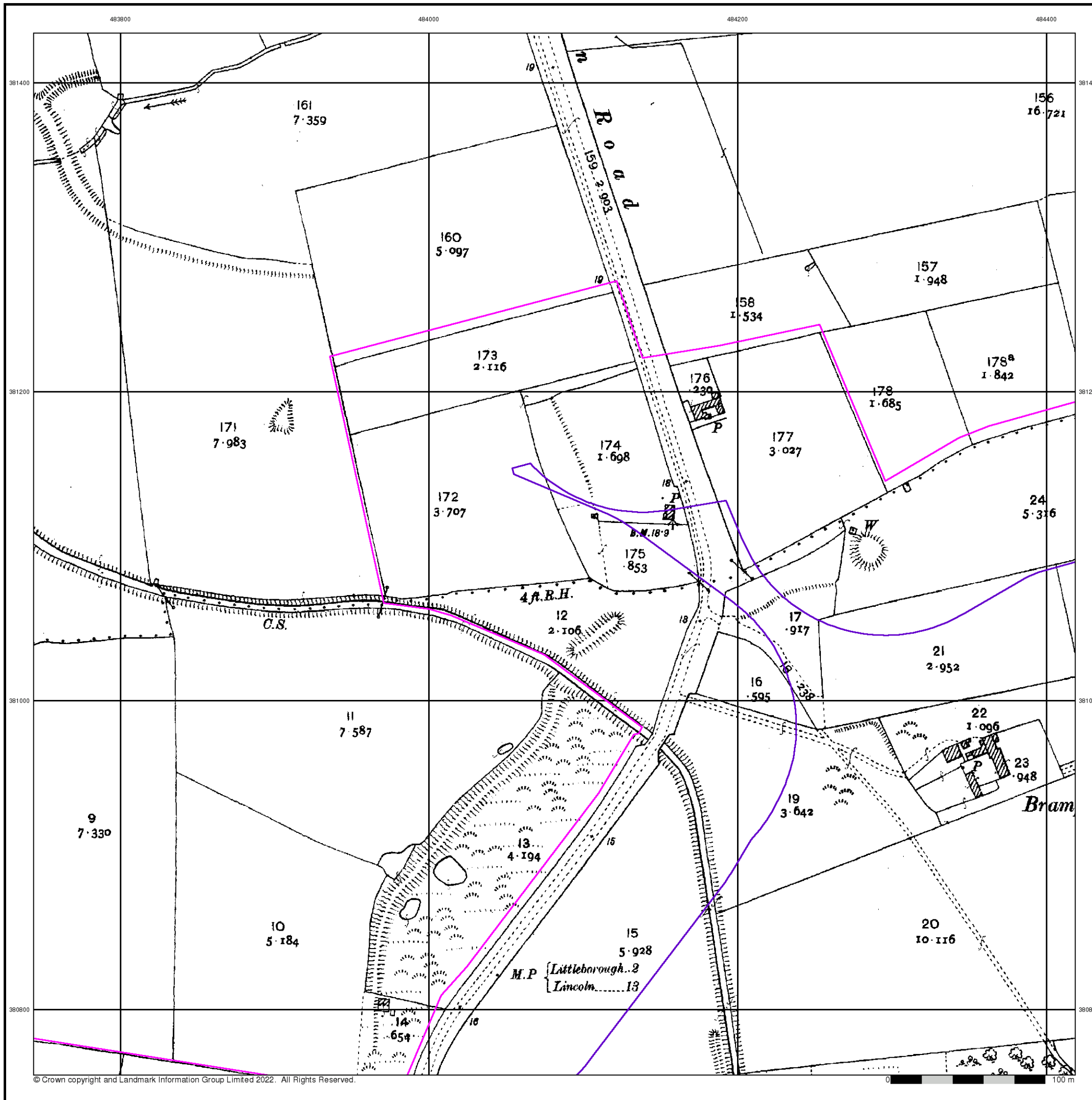

Lincolnshire

Published 1920

Source map scale - 1:2,500

The historical maps shown were reproduced from maps predominantly held at the scale adopted for England, Wales and Scotland in the 1840's. In 1854 the 1:2,500 scale was adopted for mapping urban areas and by 1896 it covered the whole of what were considered to be the cultivated parts of Great Britain. The published date given below is often some years later than the surveyed date. Before 1938, all OS maps were based on the Cassini Projection, with independent surveys of a single county or group of counties, giving rise to significant inaccuracies in outlying areas.

Map Name(s) and Date(s)

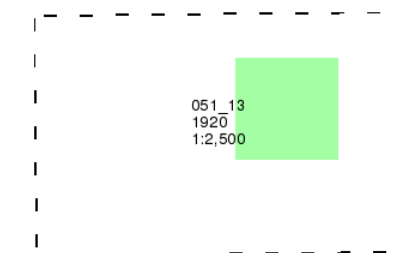

Historical Map - Segment E11

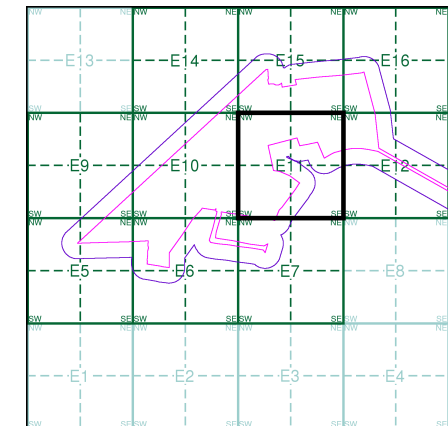

Order Details

Order Number: 298001007_1_1
 Customer Ref: 21-1098.04
 National Grid Reference: 483820, 381060
 Slice: E
 Site Area (Ha): 471.82
 Search Buffer (m): 100

Site Details

West Barton 1

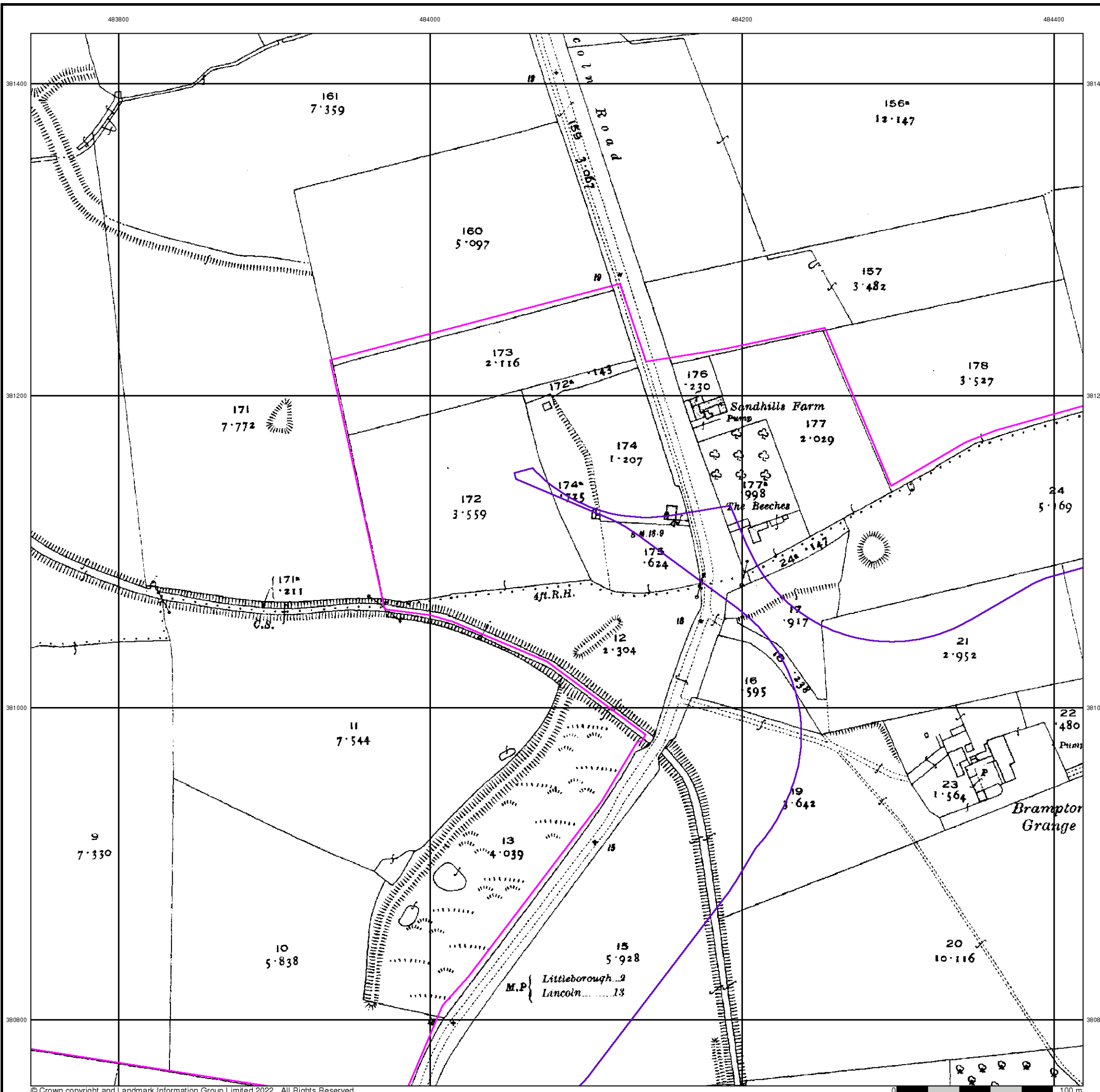

Ordnance Survey Plan
Published 1974 - 1975
Source map scale - 1:2,500

The historical maps shown were reproduced from maps predominantly held at the scale adopted for England, Wales and Scotland in the 1840's. In 1854 the 1:2,500 scale was adopted for mapping urban areas and by 1896 it covered the whole of what were considered to be the cultivated parts of Great Britain. The published date given below is often some years later than the surveyed date. Before 1938, all OS maps were based on the Cassini Projection, with independent surveys of a single county or group of counties, giving rise to significant inaccuracies in outlying areas.

Map Name(s) and Date(s)

SK8381 1975 12,500	SK8481 1974 12,500
SK8380 1974 12,500	SK8480 1974 12,500

Historical Map - Segment E11

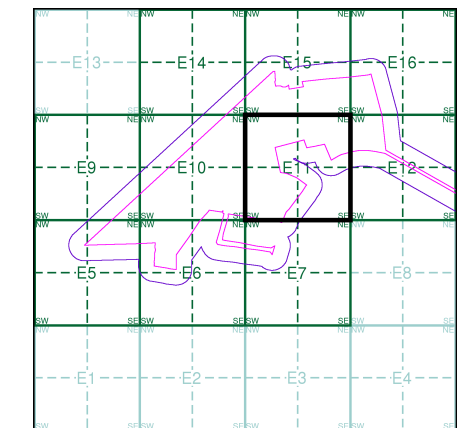

Order Details

Order Number: 298001007_1_1
 Customer Ref: 21-1098.04
 National Grid Reference: 483820, 381060
 Slice: E
 Site Area (Ha): 471.82
 Search Buffer (m): 100

Site Details

West Barton 1

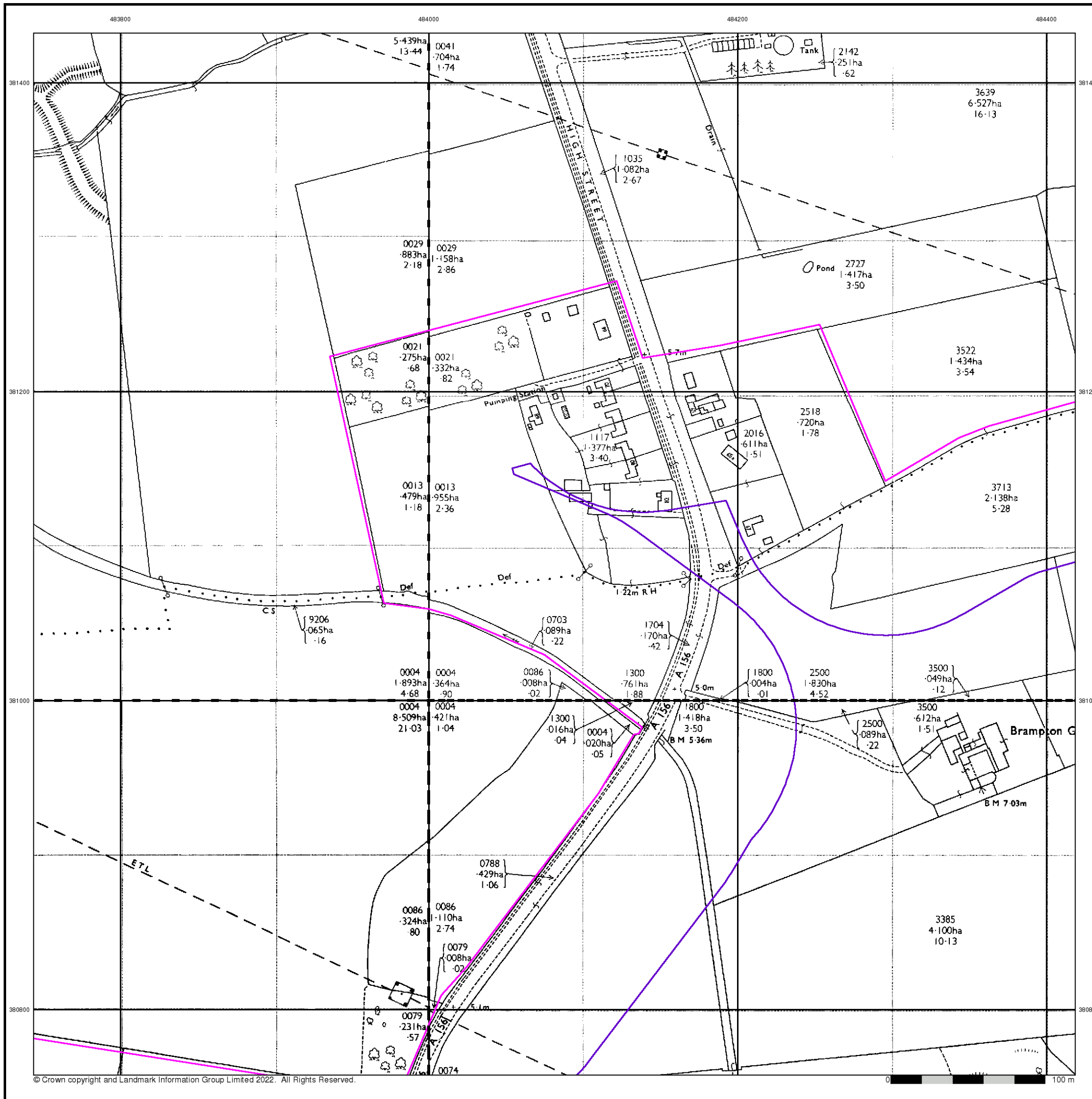

Additional SIMs

Published 1993

Source map scale - 1:2,500

The SIM cards (Ordnance Survey's 'Survey of Information on Microfilm') are further, minor editions of mapping which were produced and published in between the main editions as an area was updated. They date from 1947 to 1994, and contain detailed information on buildings, roads and land-use. These maps were produced at both 1:2,500 and 1:1,250 scales.

Map Name(s) and Date(s)

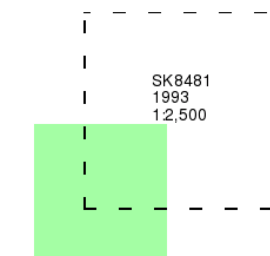

Historical Map - Segment E11

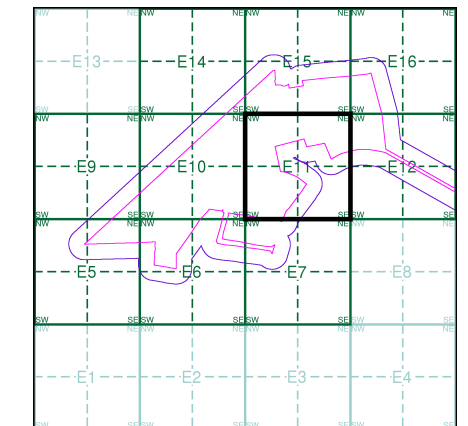

Order Details

Order Number: 298001007_1_1
 Customer Ref: 21-1098.04
 National Grid Reference: 483820, 381060
 Slice: E
 Site Area (Ha): 471.82
 Search Buffer (m): 100

Site Details

West Barton 1

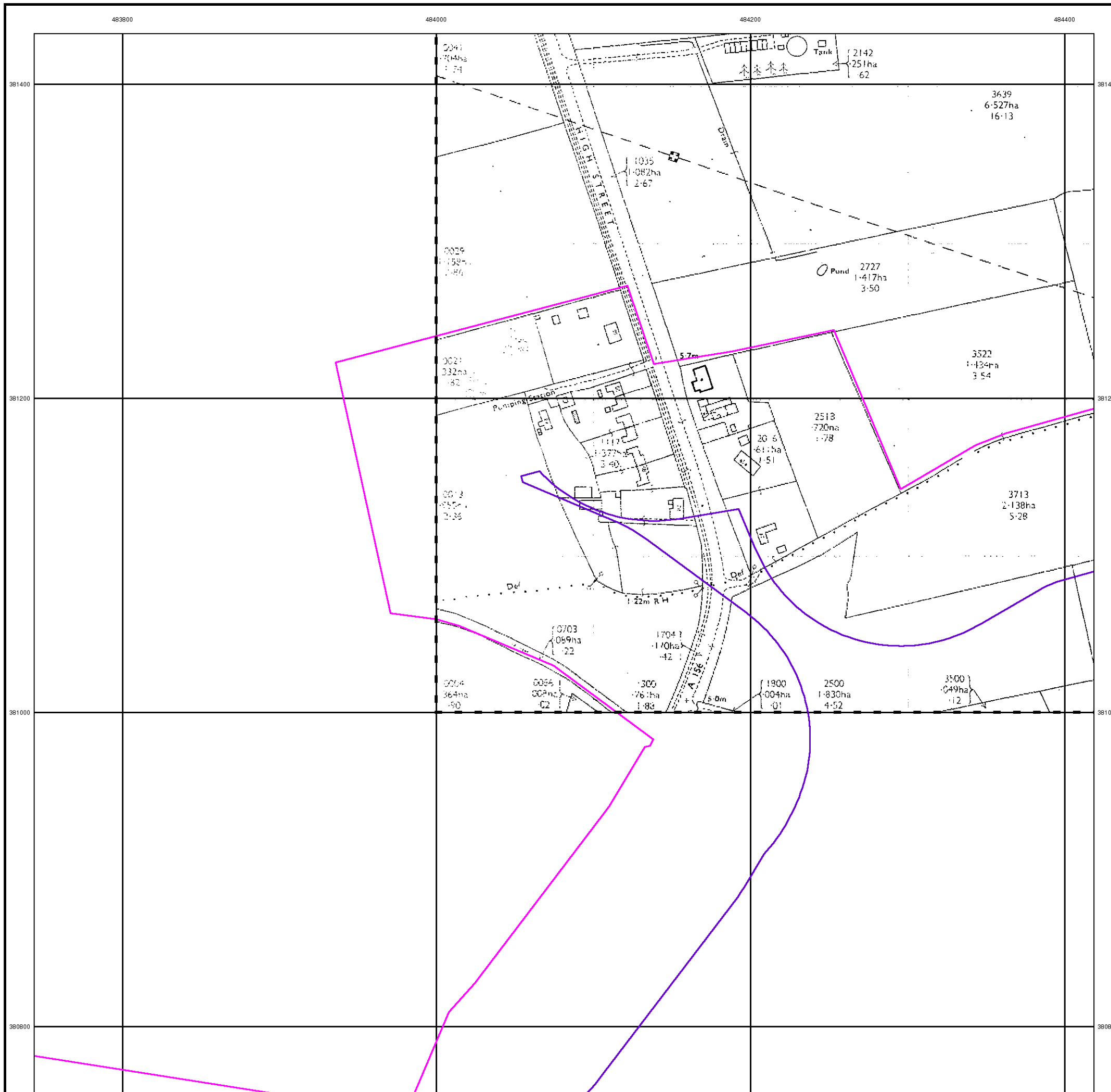

Large-Scale National Grid Data

Published 1994

Source map scale - 1:2,500

'Large Scale National Grid Data' superseded SIM cards (Ordnance Survey's 'Survey of Information on Microfilm') in 1992, and continued to be produced until 1999. These maps were the fore-runners of digital mapping and so provide detailed information on houses and roads, but tend to show less topographic features such as vegetation. These maps were produced at both 1:2,500 and 1:1,250 scales.

Map Name(s) and Date(s)

SK8381	SK8481
1994	1994
1:2,500	1:2,500
SK8380	SK8480
1994	1994
1:2,500	1:2,500

Historical Map - Segment E11

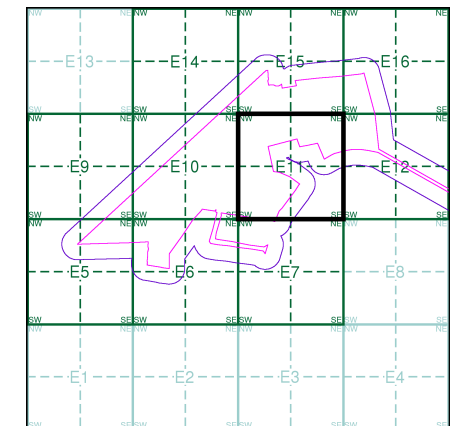

Order Details

Order Number: 298001007_1_1
 Customer Ref: 21-1098.04
 National Grid Reference: 483820, 381060
 Slice: E
 Site Area (Ha): 471.82
 Search Buffer (m): 100

Site Details

West Barton 1

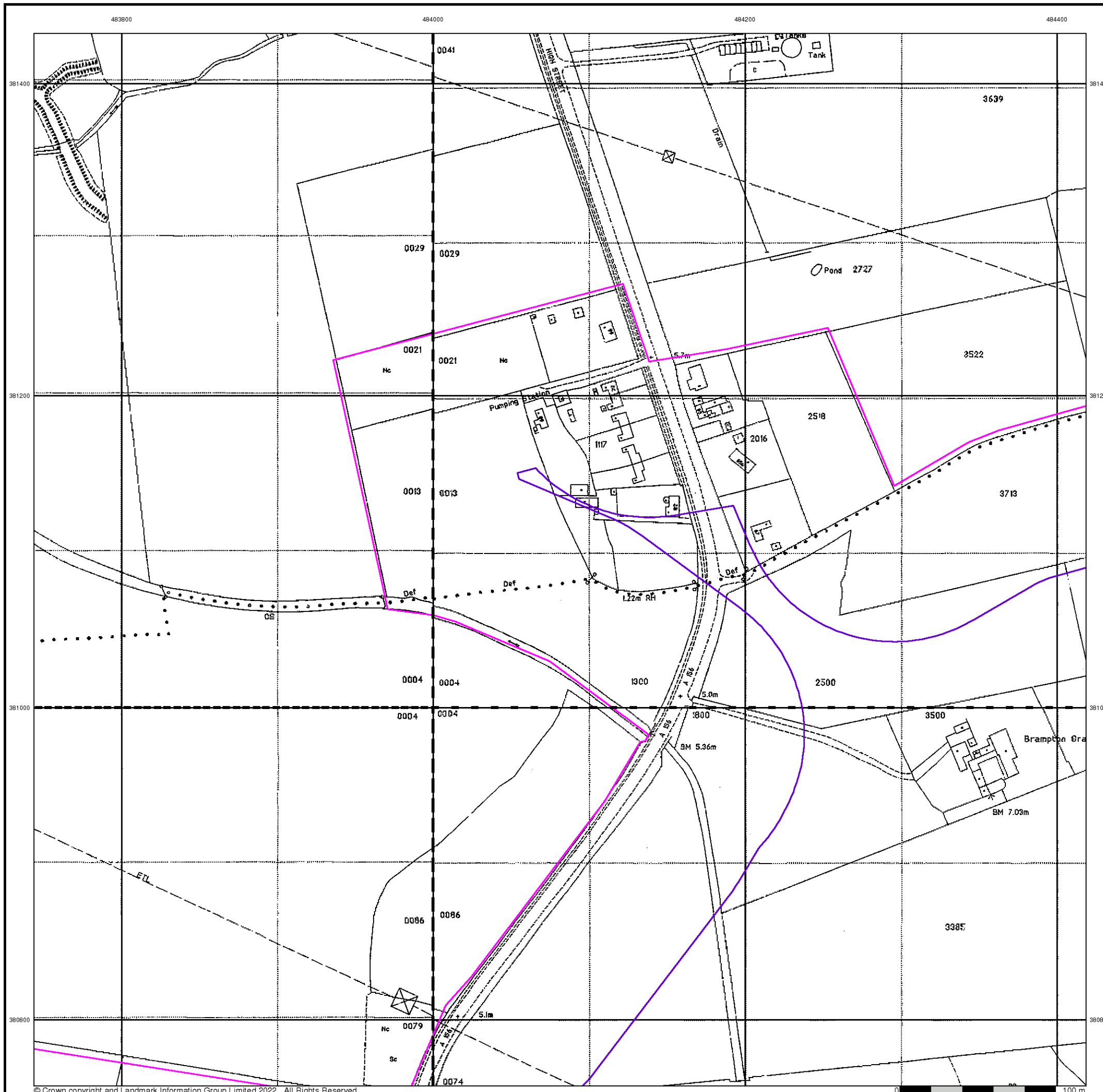

Historical Mapping Legends

Ordnance Survey County Series and Ordnance Survey Plan 1:2,500

Quarry **Gravel Pit** **Sand Pit**
Clay Pit **Shingle** **Refuse Heap**
Sloping Masonry **Flat Rock**
Marsh **Reeds** **Osiers**
Rough Pasture **Furze** **Wood**
Mixed Wood **Brushwood** **Orchard**
Fir **Ford** **Stepping Stones**
Ferry **Waterfall** **Lock**
Trig. Station **Altitude at Trig. Station**
B.M. 325.9 **Bench Mark** **Surface Level**
Arrow denotes flow of water **Antiquities (site of)**
Cutting **Embankment**
Railway crossing Road **Level Crossing** **Road crossing Railway**
Railway crossing River or Canal **Road over single stream** **Road over River or Canal**
County Boundary (Geographical)
County & Civil Parish Boundary
Administrative County & Civil Parish Boundary
County Borough Boundary (England)
County Burgh Boundary (Scotland)
Co. Boro. Bdy.
Co. Burgh Bdy.
BP BS Boundary Post or Stone **P.C.B** Police Call Box
B.R. Bridle Road **P** Pump
E.P Electricity Pylon **S.P** Signal Post
F.B. Foot Bridge **SL** Sluice
F.P. Foot Path **Sp.** Spring
G.P Guide Post or Board **T.C.B** Telephone Call Box
M.S Mile Stone **Tr.** Trough
M.P M.R Mooring Post or Ring **W** Well

Ordnance Survey Plan, Additional SIMs and Supply of Unpublished Survey Information 1:2,500 and 1:1,250

Inactive Quarry, Chalk Pit or Clay Pit **Active Quarry, Chalk Pit or Clay Pit**
Rock **Boulders**
Cliff **Slopes** **Top**
Roofed Building **Glazed Roof Building**
Sloping Masonry **Archway**
Non-Coniferous Tree (surveyed) **Coniferous Tree (surveyed)**
Non-Coniferous Trees (not surveyed) **Coniferous Trees (not surveyed)**
Orchard Tree **Scrub** **Bracken**
Coppice, Osier **Reeds** **Marsh, Saltings**
Rough Grassland **Heath** **Culvert**
Direction of water flow **Bench Mark** **Antiquity (site of)**
Cave Entrance **Triangulation Station** **Electricity Pylon**
Electricity Transmission Line
County Boundary (Geographical)
County & Civil Parish Boundary
Civil Parish Boundary
Admin. County or County Bor. Boundary
London Borough Boundary
Symbol marking point where boundary mereing changes
BH Beer House **P** Pillar, Pole or Post
BP, BS Boundary Post or Stone **PO** Post Office
Cn, C Capstan, Crane **PC** Public Convenience
Chy Chimney **PH** Public House
D Fn Drinking Fountain **Pp** Pump
EI P Electricity Pillar or Post **SB, S Br** Signal Box or Bridge
FAP Fire Alarm Pillar **SP, SL** Signal Post or Light
FB Foot Bridge **Spr** Spring
GP Guide Post **Tk** Tank or Track
H Hydrant or Hydraulic **TCB** Telephone Call Box
LC Level Crossing **TCP** Telephone Call Post
MH Manhole **Tr** Trough
MP Mile Post or Mooring Post **Wr Pt, Wr T** Water Point, Water Tap
MS Mile Stone **W** Well
NTL Normal Tidal Limit **Wd Pp** Wind Pump

Large-Scale National Grid Data 1:2,500 and 1:1,250

Cliff **Slopes** **Top**
Rock **Rock (scattered)**
Boulders **Boulders (scattered)**
Positioned Boulder **Scree**
Non-Coniferous Tree (surveyed) **Coniferous Tree (surveyed)**
Non-Coniferous Trees (not surveyed) **Coniferous Trees (not surveyed)**
Orchard Tree **Scrub** **Bracken**
Coppice, Osier **Reeds** **Marsh, Saltings**
Rough Grassland **Heath** **Culvert**
Direction of water flow **Triangulation Station** **Antiquity (site of)**
Electricity Transmission Line **Electricity Pylon**
BM 231.60m Bench Mark **Buildings with Building Seed**
Roofed Building **Glazed Roof Building**
Civil parish/community boundary
District boundary
County boundary
Boundary post/stone
Boundary mereing symbol (note: these always appear in opposed pairs or groups of three)
Bks Barracks **P** Pillar, Pole or Post
Bty Battery **PO** Post Office
Cemy Cemetery **PC** Public Convenience
Chy Chimney **Pp** Pump
Cis Cistern **Ppg Sta** Pumping Station
Dismtd Rly Dismantled Railway **PW** Place of Worship
EI Gen Sta Electricity Generating Station **Sewage Ppg Sta** Sewage Pumping Station
EI P Electricity Pole, Pillar **SB, S Br** Signal Box or Bridge
EI Sub Sta Electricity Sub Station **SP, SL** Signal Post or Light
FB Filter Bed **Spr** Spring
Fn / D Fn Fountain / Drinking Ftn. **Tk** Tank or Track
Gas Gov Gas Valve Compound **Tr** Trough
GVC Gas Governor **Wd Pp** Wind Pump
GP Guide Post **Wr Pt, Wr T** Water Point, Water Tap
MH Manhole **Wks** Works (building or area)
MP, MS Mile Post or Mile Stone **W** Well



Historical Mapping & Photography included:

Mapping Type	Scale	Date	Pg
Lincolnshire	1:2,500	1886	2
Nottinghamshire	1:2,500	1899	3
Lincolnshire	1:2,500	1906	4
Lincolnshire	1:2,500	1920	5
Ordnance Survey Plan	1:2,500	1974	6
Additional SIMs	1:2,500	1993	7
Large-Scale National Grid Data	1:2,500	1994	8

Historical Map - Segment E12

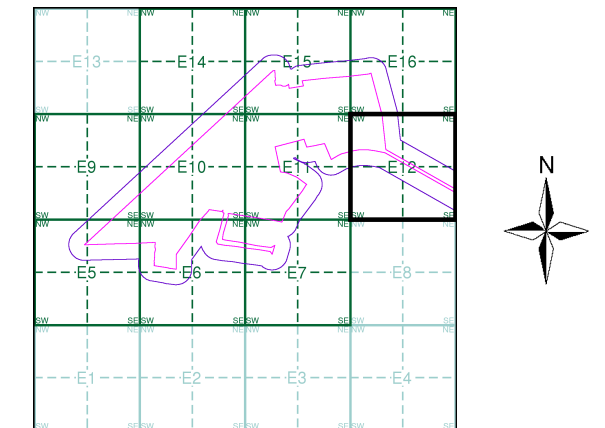

Order Details

Order Number: 298001007_1_1
 Customer Ref: 21-1098.04
 National Grid Reference: 483820, 381060
 Slice: E
 Site Area (Ha): 471.82
 Search Buffer (m): 100

Site Details

West Barton 1



Tel: 0844 844 9952
 Fax: 0844 844 9951
 Web: [REDACTED]

Lincolnshire

Published 1886

Source map scale - 1:2,500

The historical maps shown were reproduced from maps predominantly held at the scale adopted for England, Wales and Scotland in the 1840's. In 1854 the 1:2,500 scale was adopted for mapping urban areas and by 1896 it covered the whole of what were considered to be the cultivated parts of Great Britain. The published date given below is often some years later than the surveyed date. Before 1938, all OS maps were based on the Cassini Projection, with independent surveys of a single county or group of counties, giving rise to significant inaccuracies in outlying areas.

Map Name(s) and Date(s)

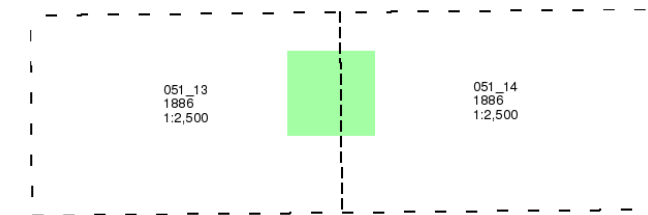

Historical Map - Segment E12

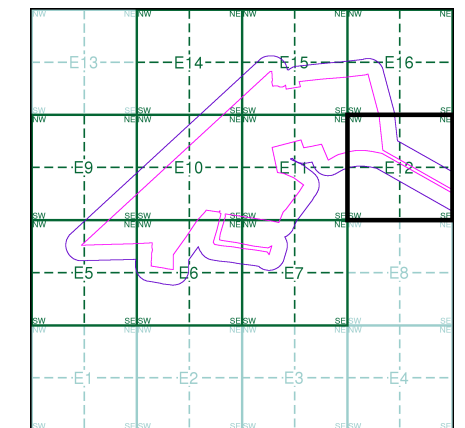

Order Details

Order Number: 298001007_1_1
 Customer Ref: 21-1098.04
 National Grid Reference: 483820, 381060
 Slice: E
 Site Area (Ha): 471.82
 Search Buffer (m): 100

Site Details

West Barton 1

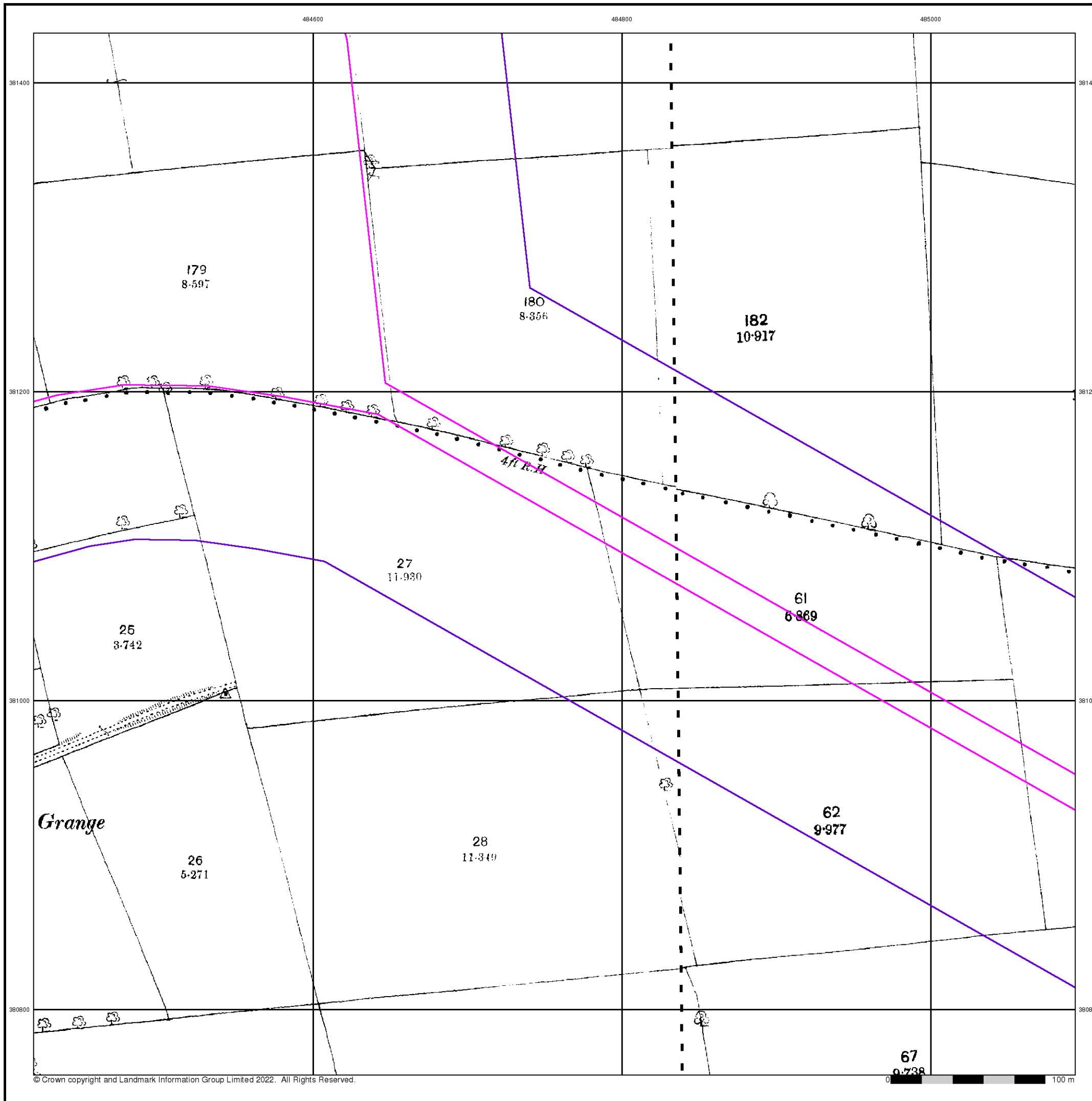

Nottinghamshire

Published 1899

Source map scale - 1:2,500

The historical maps shown were reproduced from maps predominantly held at the scale adopted for England, Wales and Scotland in the 1840's. In 1854 the 1:2,500 scale was adopted for mapping urban areas and by 1896 it covered the whole of what were considered to be the cultivated parts of Great Britain. The published date given below is often some years later than the surveyed date. Before 1938, all OS maps were based on the Cassini Projection, with independent surveys of a single county or group of counties, giving rise to significant inaccuracies in outlying areas.

Map Name(s) and Date(s)

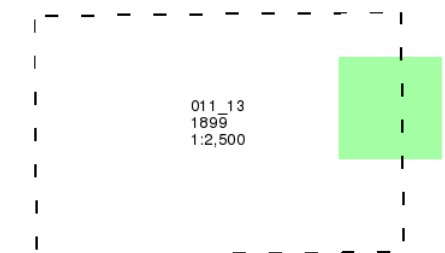

Historical Map - Segment E12

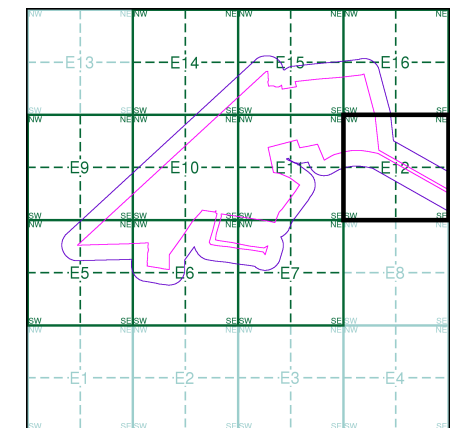

Order Details

Order Number: 298001007_1_1
 Customer Ref: 21-1098.04
 National Grid Reference: 483820, 381060
 Slice: E
 Site Area (Ha): 471.82
 Search Buffer (m): 100

Site Details

West Barton 1

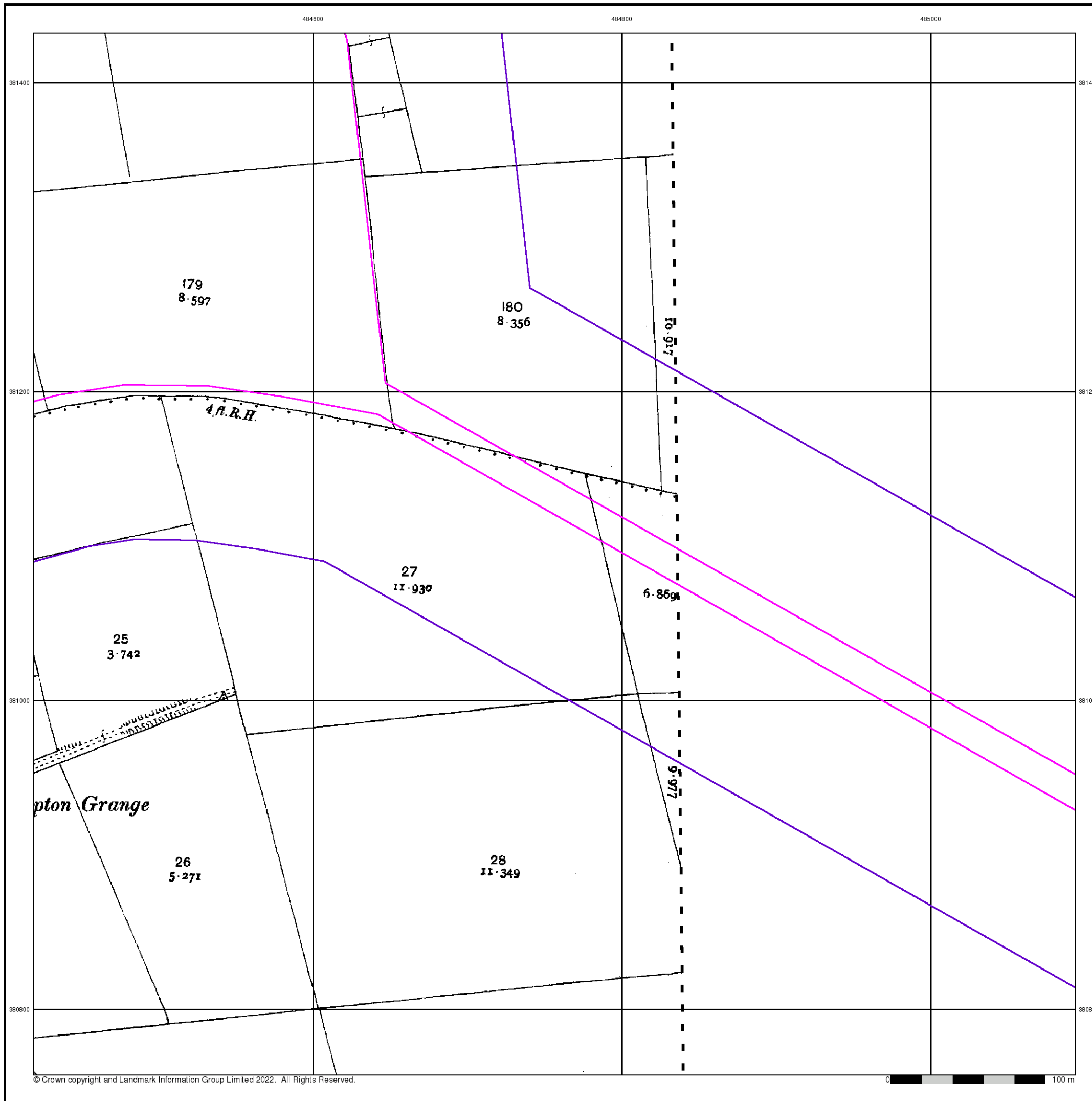

Lincolnshire

Published 1906

Source map scale - 1:2,500

The historical maps shown were reproduced from maps predominantly held at the scale adopted for England, Wales and Scotland in the 1840's. In 1854 the 1:2,500 scale was adopted for mapping urban areas and by 1896 it covered the whole of what were considered to be the cultivated parts of Great Britain. The published date given below is often some years later than the surveyed date. Before 1938, all OS maps were based on the Cassini Projection, with independent surveys of a single county or group of counties, giving rise to significant inaccuracies in outlying areas.

Map Name(s) and Date(s)

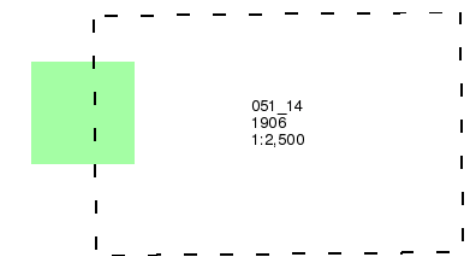

Historical Map - Segment E12

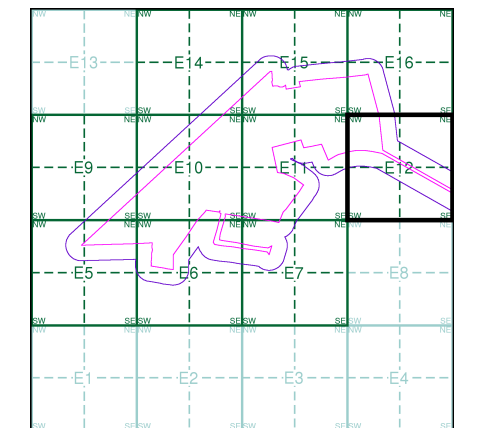

Order Details

Order Number: 298001007_1_1
 Customer Ref: 21-1098.04
 National Grid Reference: 483820, 381060
 Slice: E
 Site Area (Ha): 471.82
 Search Buffer (m): 100

Site Details

West Barton 1

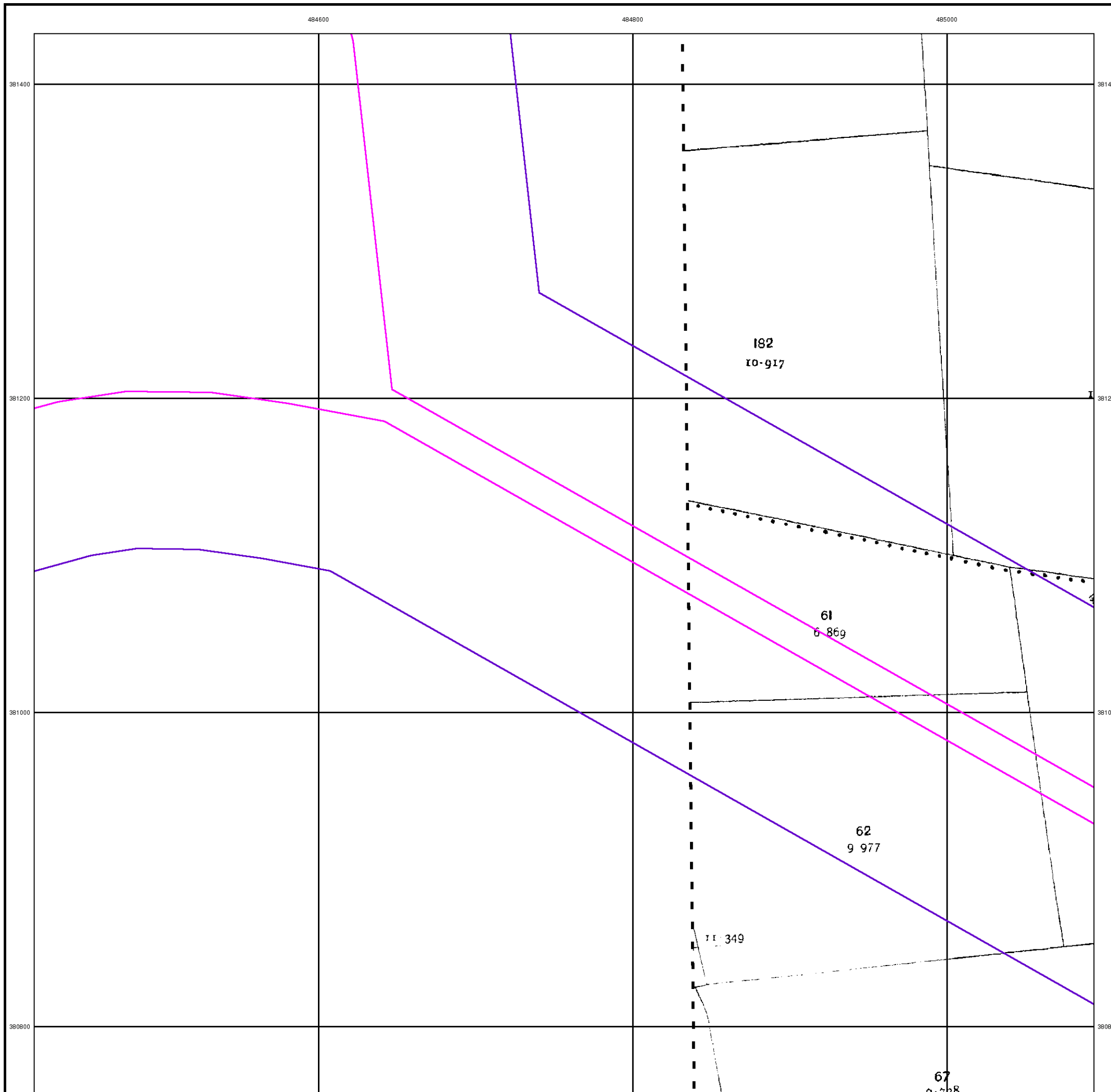

Lincolnshire

Published 1920

Source map scale - 1:2,500

The historical maps shown were reproduced from maps predominantly held at the scale adopted for England, Wales and Scotland in the 1840's. In 1854 the 1:2,500 scale was adopted for mapping urban areas and by 1896 it covered the whole of what were considered to be the cultivated parts of Great Britain. The published date given below is often some years later than the surveyed date. Before 1938, all OS maps were based on the Cassini Projection, with independent surveys of a single county or group of counties, giving rise to significant inaccuracies in outlying areas.

Map Name(s) and Date(s)

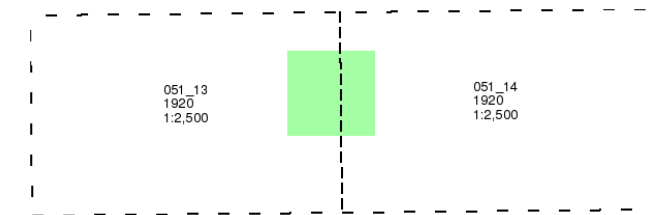

Historical Map - Segment E12

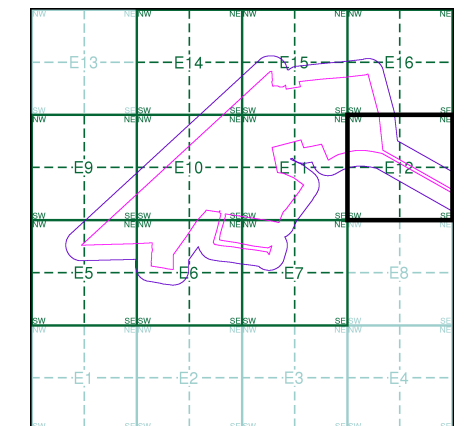

Order Details

Order Number: 298001007_1_1
 Customer Ref: 21-1098.04
 National Grid Reference: 483820, 381060
 Slice: E
 Site Area (Ha): 471.82
 Search Buffer (m): 100

Site Details

West Barton 1

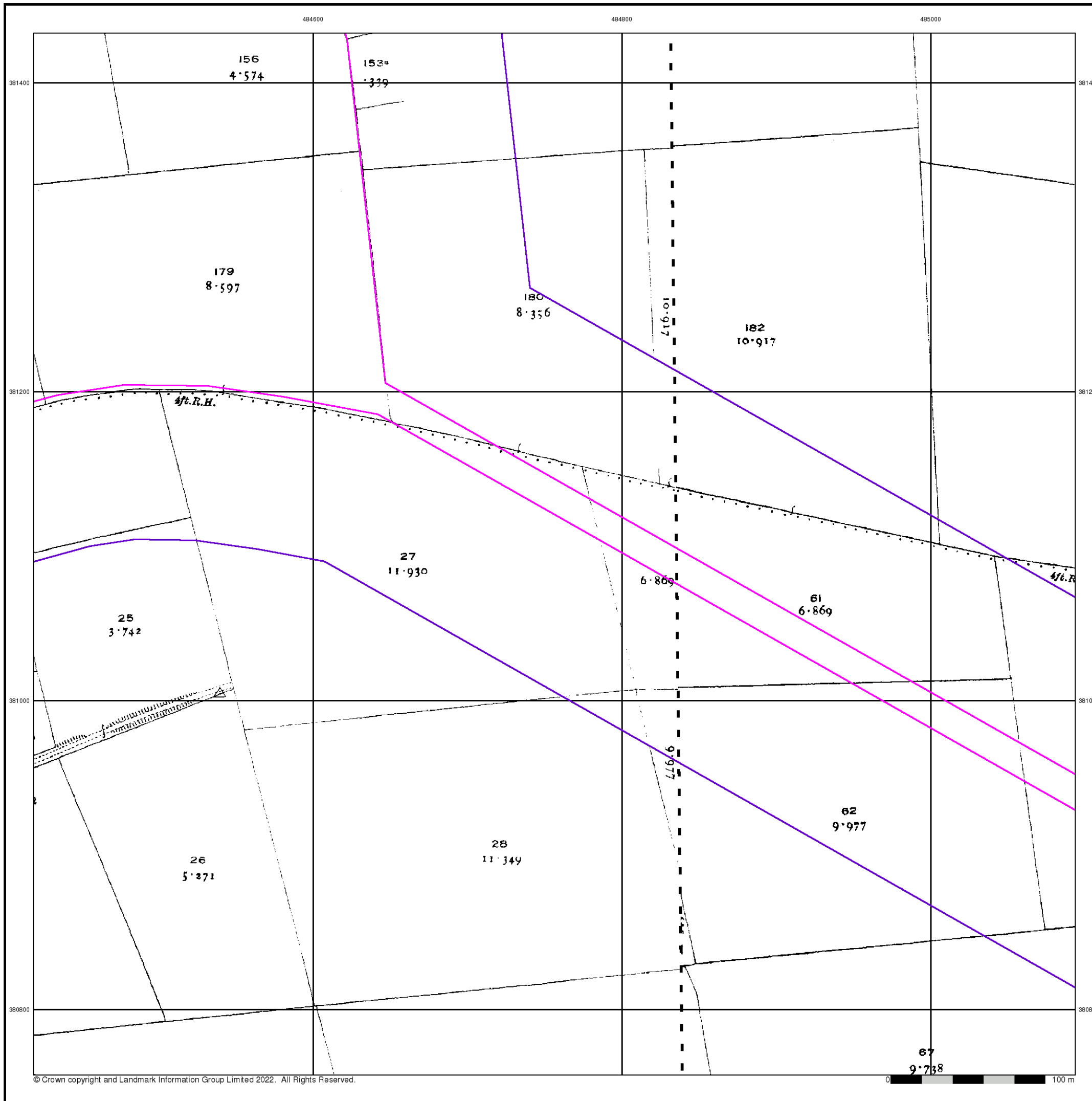

Ordnance Survey Plan

Published 1974

Source map scale - 1:2,500

The historical maps shown were reproduced from maps predominantly held at the scale adopted for England, Wales and Scotland in the 1840's. In 1854 the 1:2,500 scale was adopted for mapping urban areas and by 1896 it covered the whole of what were considered to be the cultivated parts of Great Britain. The published date given below is often some years later than the surveyed date. Before 1938, all OS maps were based on the Cassini Projection, with independent surveys of a single county or group of counties, giving rise to significant inaccuracies in outlying areas.

Map Name(s) and Date(s)

SK8481 1974 1:2,500	SK8581 1974 1:2,500
SK8480 1974 1:2,500	SK8580 1974 1:2,500

Historical Map - Segment E12

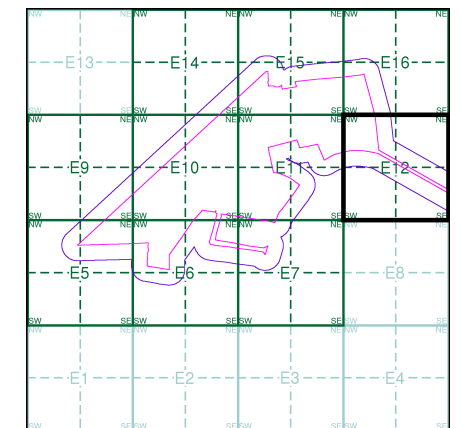

Order Details

Order Number: 298001007_1_1
 Customer Ref: 21-1098.04
 National Grid Reference: 483820, 381060
 Slice: E
 Site Area (Ha): 471.82
 Search Buffer (m): 100

Site Details

West Barton 1

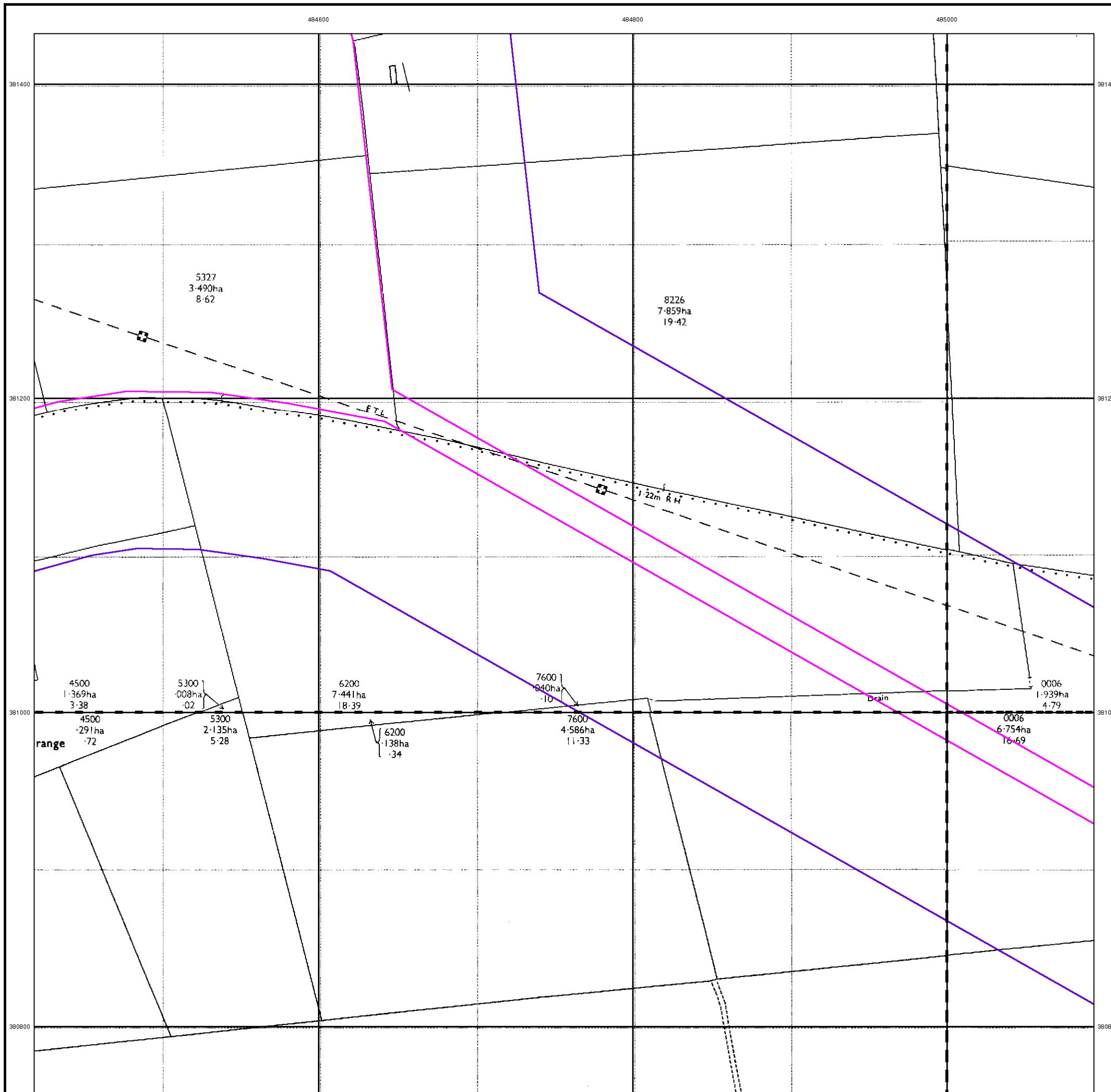

Additional SIMs

Published 1993

Source map scale - 1:2,500

The SIM cards (Ordnance Survey's 'Survey of Information on Microfilm') are further, minor editions of mapping which were produced and published in between the main editions as an area was updated. They date from 1947 to 1994, and contain detailed information on buildings, roads and land-use. These maps were produced at both 1:2,500 and 1:1,250 scales.

Map Name(s) and Date(s)

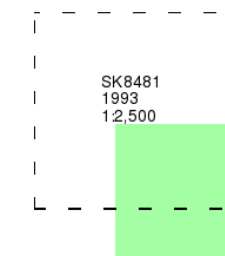

Historical Map - Segment E12

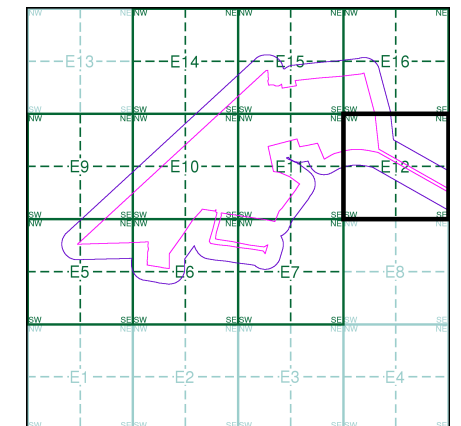

Order Details

Order Number: 298001007_1_1
 Customer Ref: 21-1098.04
 National Grid Reference: 483820, 381060
 Slice: E
 Site Area (Ha): 471.82
 Search Buffer (m): 100

Site Details

West Barton 1

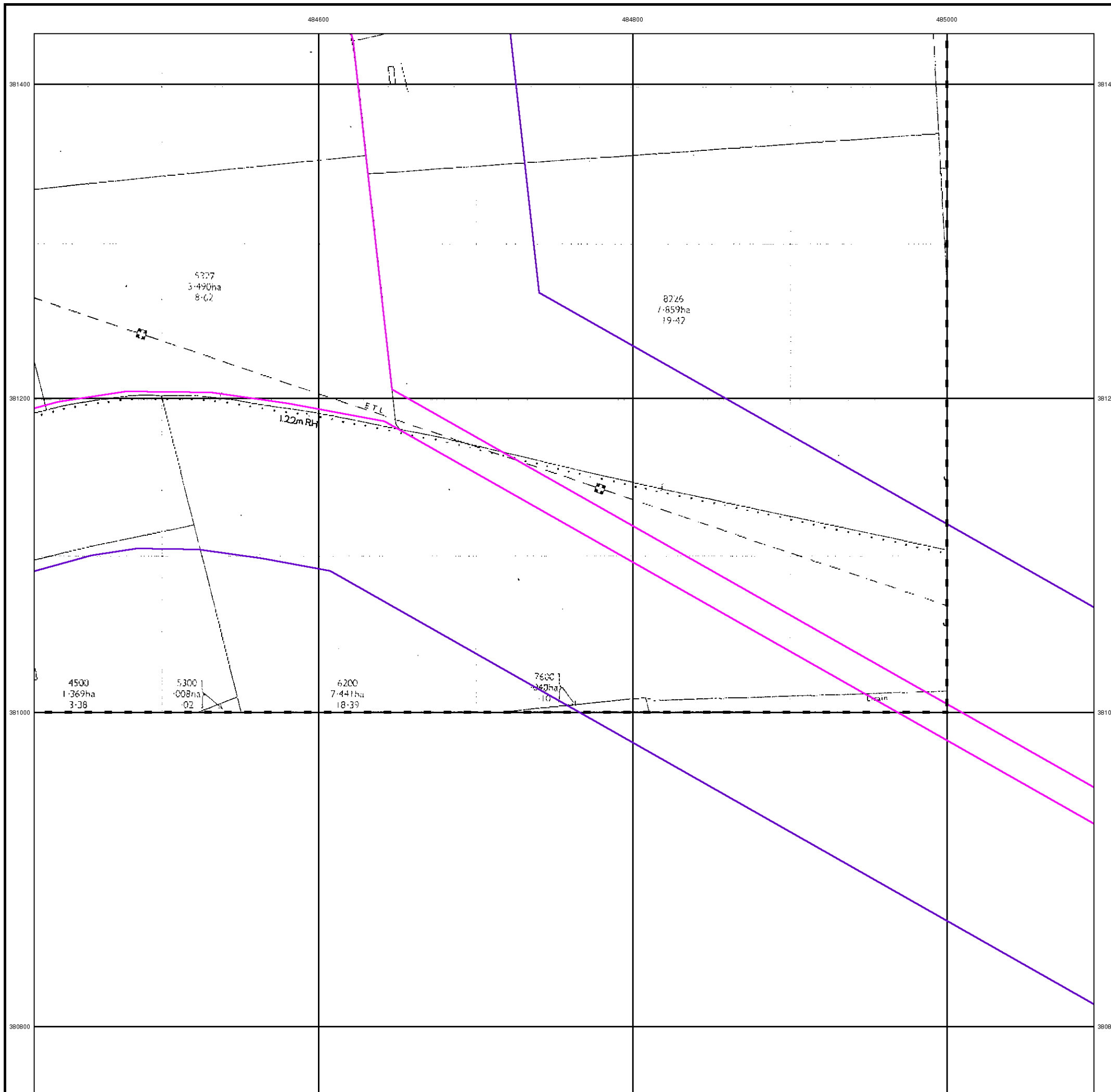

Large-Scale National Grid Data

Published 1994

Source map scale - 1:2,500

'Large Scale National Grid Data' superseded SIM cards (Ordnance Survey's 'Survey of Information on Microfilm') in 1992, and continued to be produced until 1999. These maps were the fore-runners of digital mapping and so provide detailed information on houses and roads, but tend to show less topographic features such as vegetation. These maps were produced at both 1:2,500 and 1:1,250 scales.

Map Name(s) and Date(s)

SK8481 1994 1:2,500	SK8581 1994 1:2,500
SK8480 1994 1:2,500	SK8580 1994 1:2,500

Historical Map - Segment E12

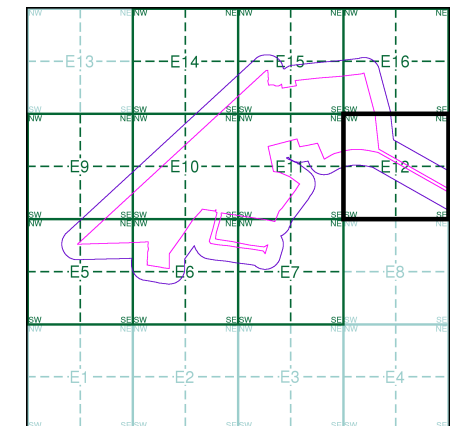

Order Details

Order Number: 298001007_1_1
 Customer Ref: 21-1098.04
 National Grid Reference: 483820, 381060
 Slice: E
 Site Area (Ha): 471.82
 Search Buffer (m): 100

Site Details

West Barton 1

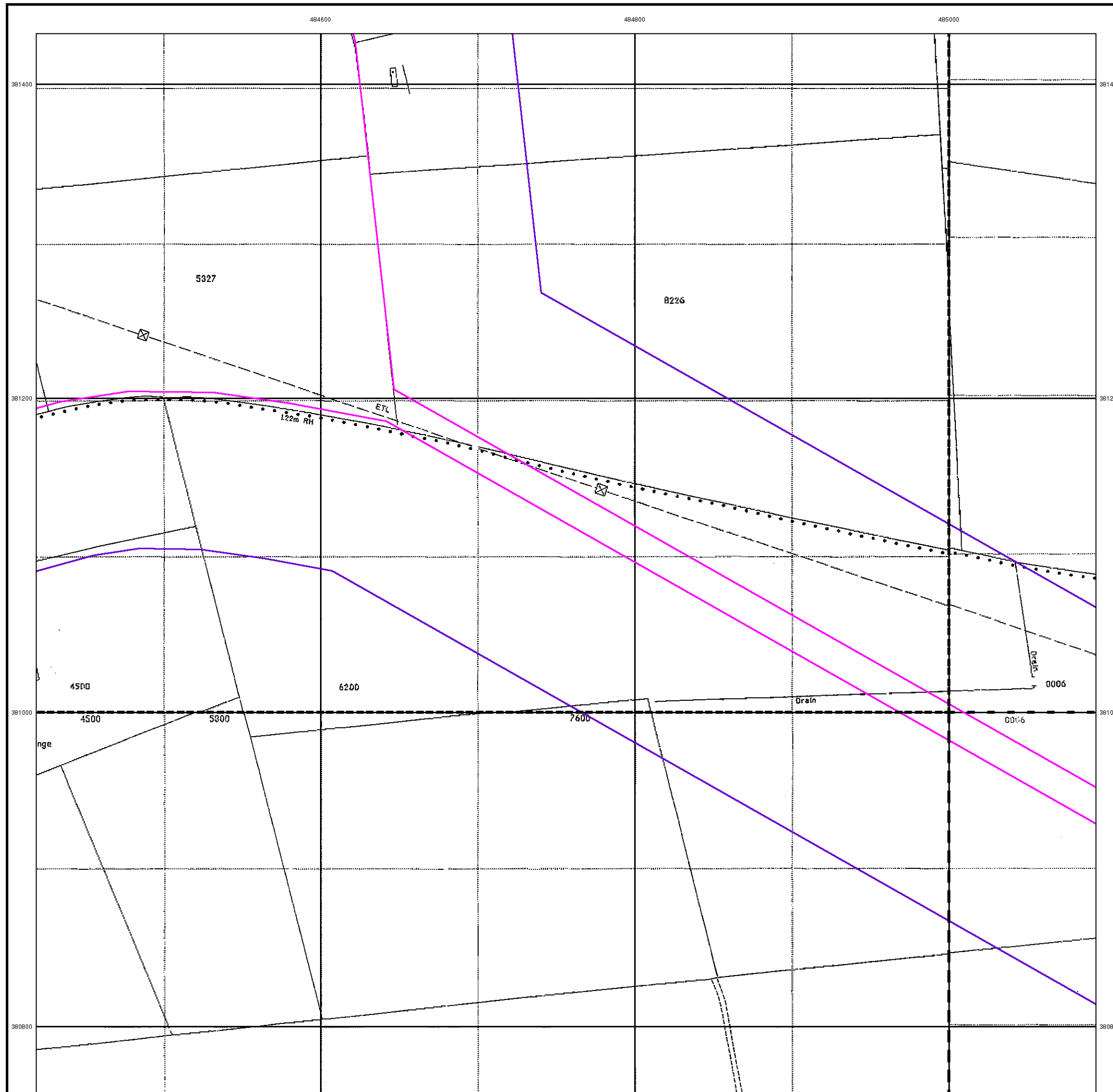

Historical Mapping Legends

Ordnance Survey County Series and Ordnance Survey Plan 1:2,500

Quarry **Gravel Pit** **Sand Pit**
Clay Pit **Shingle** **Refuse Heap**
Sloping Masonry **Flat Rock**
Marsh **Reeds** **Osiers**
Rough Pasture **Furze** **Wood**
Mixed Wood **Brushwood** **Orchard**
Fir **Ford** **Stepping Stones**
Ferry **Waterfall** **Lock**
Trig. Station **Altitude at Trig. Station**
B.M. 325.9 **Bench Mark** **Surface Level**
Arrow denotes flow of water **Antiquities (site of)**
Cutting **Embankment**
Railway crossing Road **Level Crossing** **Road crossing Railway**
Railway crossing River or Canal **Road over single stream** **Road over River or Canal**
County Boundary (Geographical)
County & Civil Parish Boundary
Administrative County & Civil Parish Boundary
County Borough Boundary (England)
County Burgh Boundary (Scotland)
Co. Boro. Bdy.
Co. Burgh Bdy.
BP BS Boundary Post or Stone **P.C.B** Police Call Box
B.R. Bridle Road **P** Pump
E.P Electricity Pylon **S.P** Signal Post
F.B. Foot Bridge **SL** Sluice
F.P. Foot Path **Sp.** Spring
G.P Guide Post or Board **T.C.B** Telephone Call Box
M.S Mile Stone **Tr.** Trough
M.P M.R Mooring Post or Ring **W** Well

Ordnance Survey Plan, Additional SIMs and Supply of Unpublished Survey Information 1:2,500 and 1:1,250

Inactive Quarry, Chalk Pit or Clay Pit **Active Quarry, Chalk Pit or Clay Pit**
Rock **Boulders**
Cliff **Slopes** **Top**
Roofed Building **Glazed Roof Building**
Sloping Masonry **Archway**
Non-Coniferous Tree (surveyed) **Coniferous Tree (surveyed)**
Non-Coniferous Trees (not surveyed) **Coniferous Trees (not surveyed)**
Orchard Tree **Scrub** **Bracken**
Coppice, Osier **Reeds** **Marsh, Saltings**
Rough Grassland **Heath** **Culvert**
Direction of water flow **Bench Mark** **Antiquity (site of)**
Cave Entrance **Triangulation Station** **Electricity Pylon**
Electricity Transmission Line
County Boundary (Geographical)
County & Civil Parish Boundary
Civil Parish Boundary
Admin. County or County Bor. Boundary
London Borough Boundary
Symbol marking point where boundary mereing changes
BH Beer House **P** Pillar, Pole or Post
BP, BS Boundary Post or Stone **PO** Post Office
Cn, C Capstan, Crane **PC** Public Convenience
Chy Chimney **PH** Public House
D Fn Drinking Fountain **Pp** Pump
EI P Electricity Pillar or Post **SB, S Br** Signal Box or Bridge
FAP Fire Alarm Pillar **SP, SL** Signal Post or Light
FB Foot Bridge **Spr** Spring
GP Guide Post **Tk** Tank or Track
H Hydrant or Hydraulic **TCB** Telephone Call Box
LC Level Crossing **TCP** Telephone Call Post
MH Manhole **Tr** Trough
MP Mile Post or Mooring Post **Wr Pt, Wr T** Water Point, Water Tap
MS Mile Stone **W** Well
NTL Normal Tidal Limit **Wd Pp** Wind Pump

Large-Scale National Grid Data 1:2,500 and 1:1,250

Cliff **Slopes** **Top**
Rock **Rock (scattered)**
Boulders **Boulders (scattered)**
Positioned Boulder **Scree**
Non-Coniferous Tree (surveyed) **Coniferous Tree (surveyed)**
Non-Coniferous Trees (not surveyed) **Coniferous Trees (not surveyed)**
Orchard Tree **Scrub** **Bracken**
Coppice, Osier **Reeds** **Marsh, Saltings**
Rough Grassland **Heath** **Culvert**
Direction of water flow **Triangulation Station** **Antiquity (site of)**
Electricity Transmission Line **Electricity Pylon**
BM 231.60m Bench Mark **Buildings with Building Seed**
Roofed Building **Glazed Roof Building**
Civil parish/community boundary
District boundary
County boundary
Boundary post/stone
Boundary mereing symbol (note: these always appear in opposed pairs or groups of three)
Bks Barracks **P** Pillar, Pole or Post
Bty Battery **PO** Post Office
Cemy Cemetery **PC** Public Convenience
Chy Chimney **Pp** Pump
Cis Cistern **Ppg Sta** Pumping Station
Dismtd Rly Dismantled Railway **PW** Place of Worship
EI Gen Sta Electricity Generating Station **Sewage Ppg Sta** Sewage Pumping Station
EI P Electricity Pole, Pillar **SB, S Br** Signal Box or Bridge
EI Sub Sta Electricity Sub Station **SP, SL** Signal Post or Light
FB Filter Bed **Spr** Spring
Fn / D Fn Fountain / Drinking Ftn. **Tk** Tank or Track
Gas Gov Gas Valve Compound **Tr** Trough
GVC Gas Governor **Wd Pp** Wind Pump
GP Guide Post **Wr Pt, Wr T** Water Point, Water Tap
MH Manhole **Wks** Works (building or area)
MP, MS Mile Post or Mile Stone **W** Well

Historical Mapping & Photography included:

Mapping Type	Scale	Date	Pg
Lincolnshire	1:2,500	1886	2
Nottinghamshire	1:2,500	1899	3
Lincolnshire	1:2,500	1920	4
Ordnance Survey Plan	1:2,500	1975	5
Large-Scale National Grid Data	1:2,500	1994	6

Historical Map - Segment E14

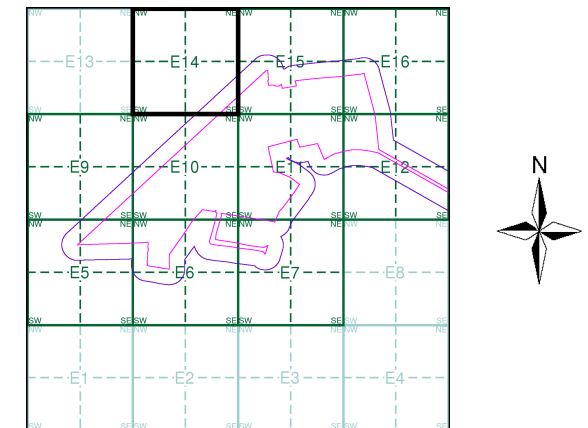

Order Details

Order Number: 298001007_1_1
 Customer Ref: 21-1098.04
 National Grid Reference: 483820, 381060
 Slice: E
 Site Area (Ha): 471.82
 Search Buffer (m): 100

Site Details

West Barton 1

Lincolnshire

Published 1886

Source map scale - 1:2,500

The historical maps shown were reproduced from maps predominantly held at the scale adopted for England, Wales and Scotland in the 1840's. In 1854 the 1:2,500 scale was adopted for mapping urban areas and by 1896 it covered the whole of what were considered to be the cultivated parts of Great Britain. The published date given below is often some years later than the surveyed date. Before 1938, all OS maps were based on the Cassini Projection, with independent surveys of a single county or group of counties, giving rise to significant inaccuracies in outlying areas.

Map Name(s) and Date(s)

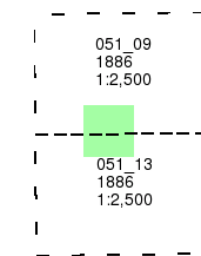

Historical Map - Segment E14

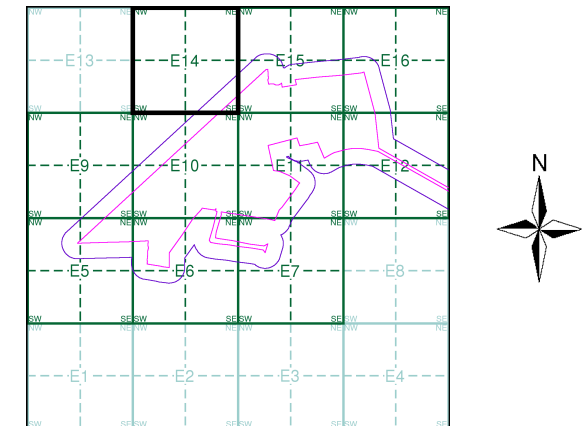

Order Details

Order Number: 298001007_1_1
 Customer Ref: 21-1098.04
 National Grid Reference: 483820, 381060
 Slice: E
 Site Area (Ha): 471.82
 Search Buffer (m): 100

Site Details

West Barton 1

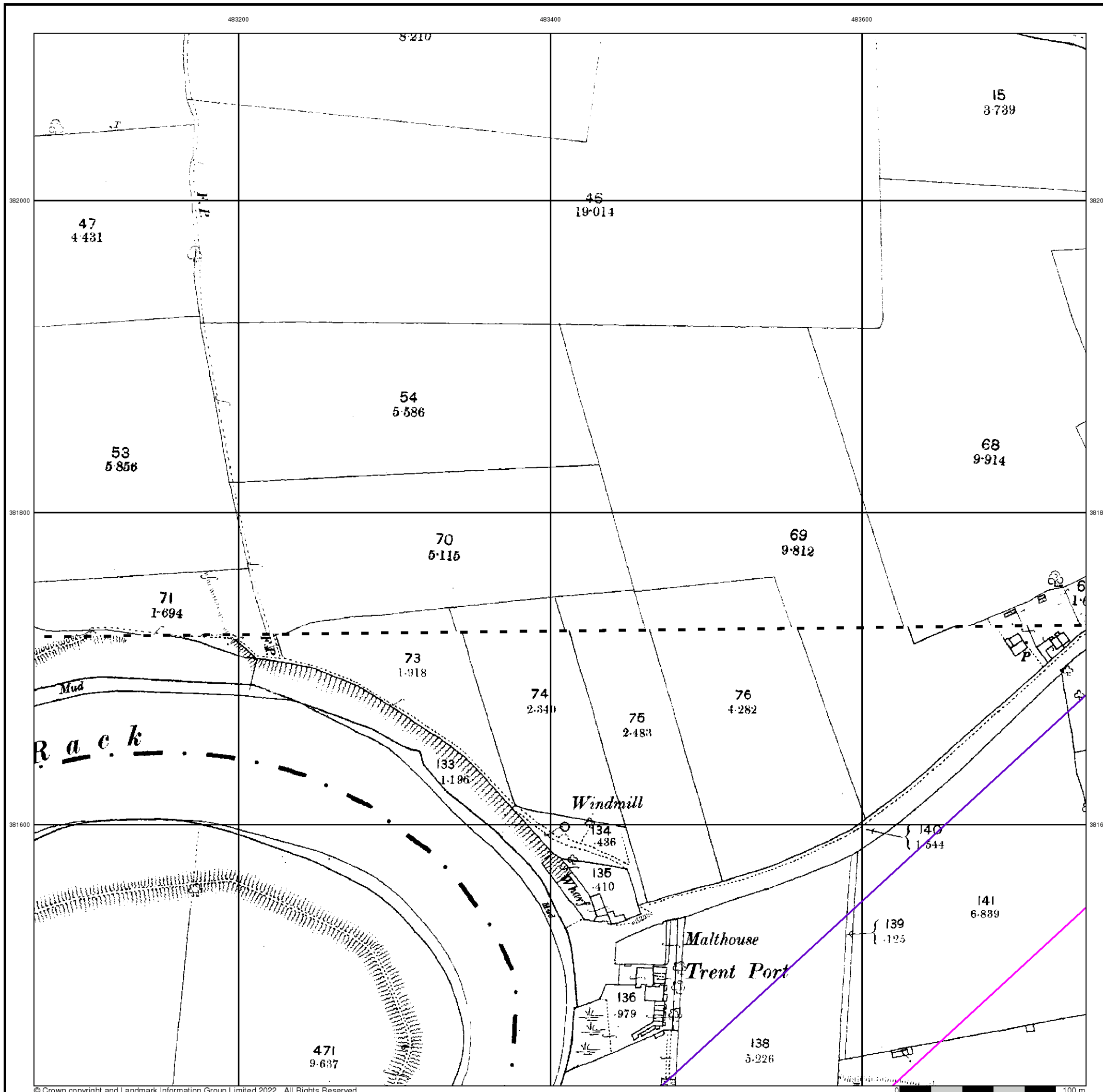

Nottinghamshire

Published 1899

Source map scale - 1:2,500

The historical maps shown were reproduced from maps predominantly held at the scale adopted for England, Wales and Scotland in the 1840's. In 1854 the 1:2,500 scale was adopted for mapping urban areas and by 1896 it covered the whole of what were considered to be the cultivated parts of Great Britain. The published date given below is often some years later than the surveyed date. Before 1938, all OS maps were based on the Cassini Projection, with independent surveys of a single county or group of counties, giving rise to significant inaccuracies in outlying areas.

Map Name(s) and Date(s)

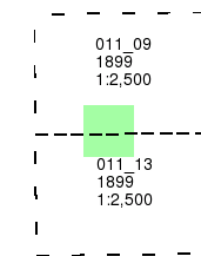

Historical Map - Segment E14

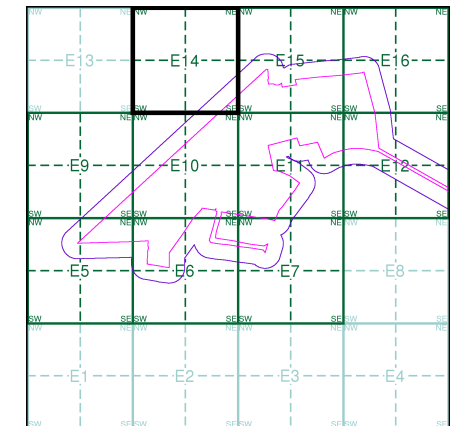

Order Details

Order Number: 298001007_1_1
 Customer Ref: 21-1098.04
 National Grid Reference: 483820, 381060
 Slice: E
 Site Area (Ha): 471.82
 Search Buffer (m): 100

Site Details

West Barton 1

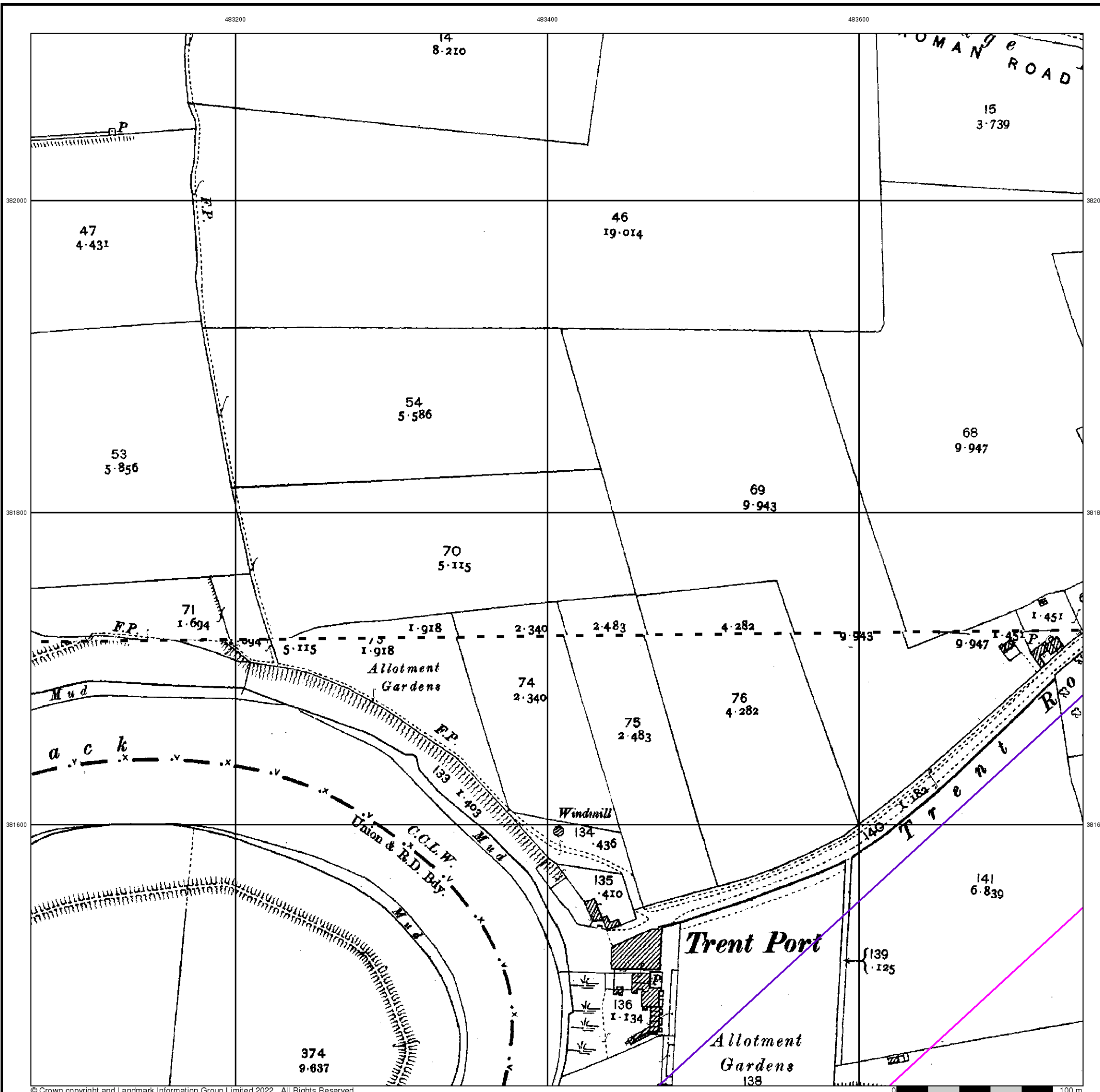

Lincolnshire

Published 1920

Source map scale - 1:2,500

The historical maps shown were reproduced from maps predominantly held at the scale adopted for England, Wales and Scotland in the 1840's. In 1854 the 1:2,500 scale was adopted for mapping urban areas and by 1896 it covered the whole of what were considered to be the cultivated parts of Great Britain. The published date given below is often some years later than the surveyed date. Before 1938, all OS maps were based on the Cassini Projection, with independent surveys of a single county or group of counties, giving rise to significant inaccuracies in outlying areas.

Map Name(s) and Date(s)

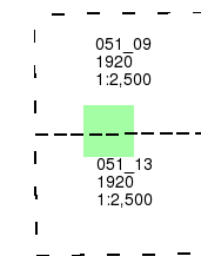

Historical Map - Segment E14

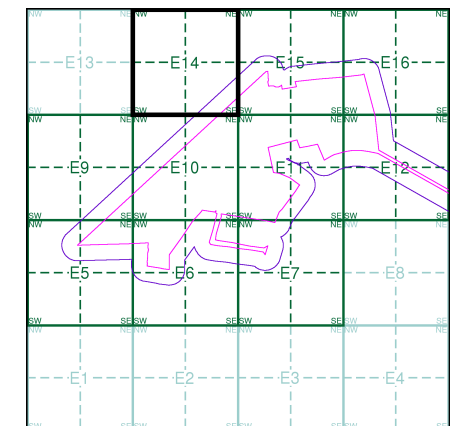

Order Details

Order Number: 298001007_1_1
 Customer Ref: 21-1098.04
 National Grid Reference: 483820, 381060
 Slice: E
 Site Area (Ha): 471.82
 Search Buffer (m): 100

Site Details

West Barton 1

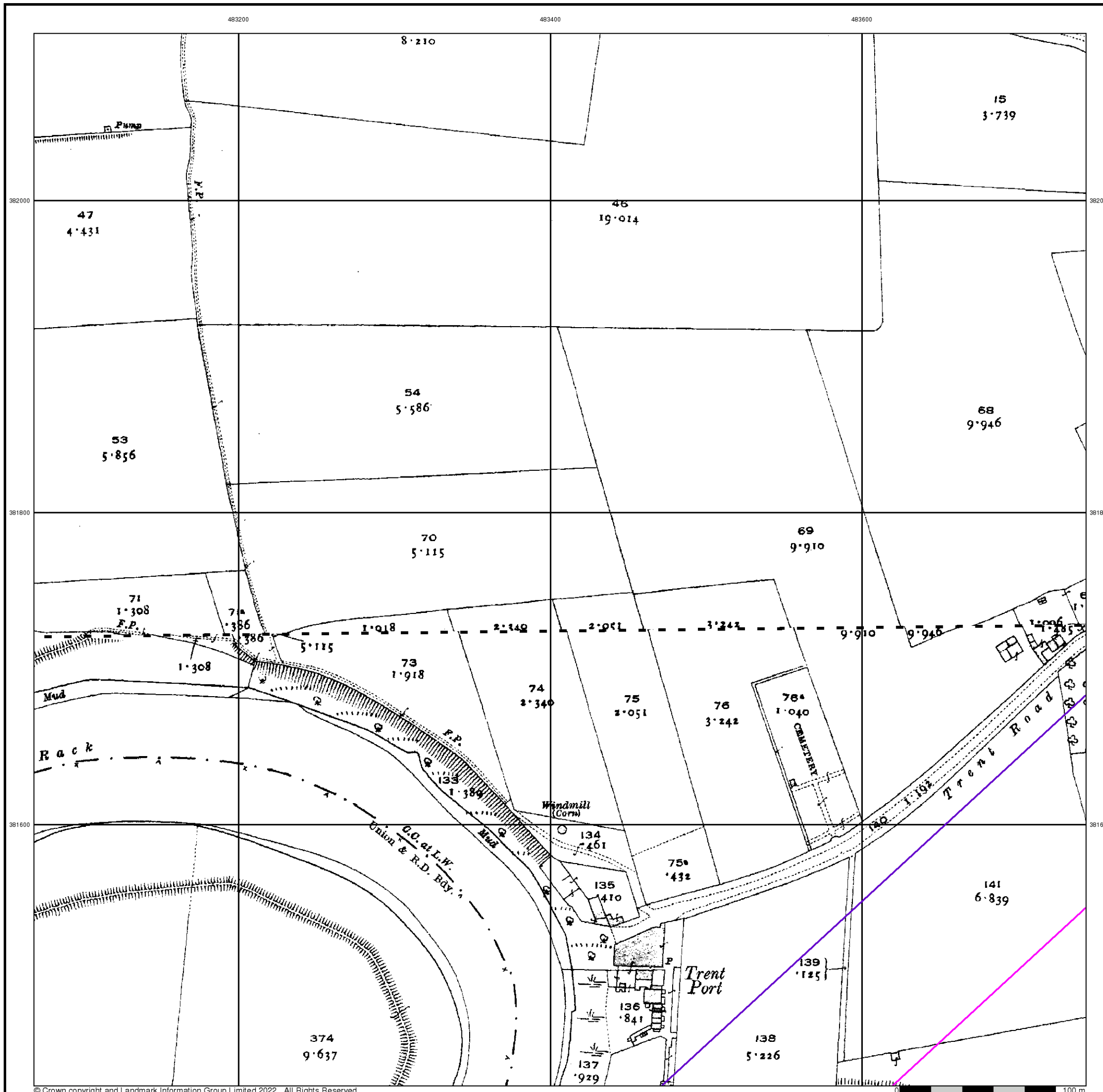

Ordnance Survey Plan
Published 1975
Source map scale - 1:2,500

The historical maps shown were reproduced from maps predominantly held at the scale adopted for England, Wales and Scotland in the 1840's. In 1854 the 1:2,500 scale was adopted for mapping urban areas and by 1896 it covered the whole of what were considered to be the cultivated parts of Great Britain. The published date given below is often some years later than the surveyed date. Before 1938, all OS maps were based on the Cassini Projection, with independent surveys of a single county or group of counties, giving rise to significant inaccuracies in outlying areas.

Map Name(s) and Date(s)

SK8382	1975	1:2,500
SK8381	1975	1:2,500

Historical Map - Segment E14

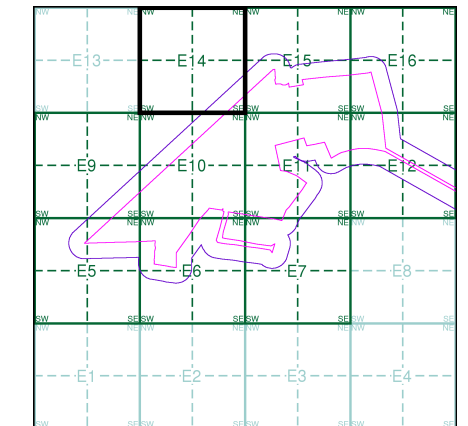

Order Details

Order Number: 298001007_1_1
 Customer Ref: 21-1098.04
 National Grid Reference: 483820, 381060
 Slice: E
 Site Area (Ha): 471.82
 Search Buffer (m): 100

Site Details

West Barton 1



Large-Scale National Grid Data
Published 1994
Source map scale - 1:2,500

'Large Scale National Grid Data' superseded SIM cards (Ordnance Survey's 'Survey of Information on Microfilm') in 1992, and continued to be produced until 1999. These maps were the fore-runners of digital mapping and so provide detailed information on houses and roads, but tend to show less topographic features such as vegetation. These maps were produced at both 1:2,500 and 1:1,250 scales.

Map Name(s) and Date(s)

SK8382	1994	1:2,500
SK8381	1994	1:2,500

Historical Map - Segment E14

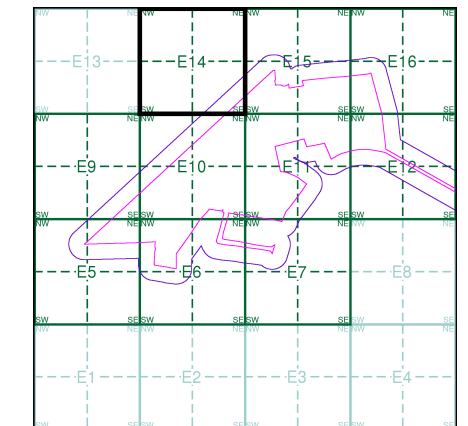

Order Details

Order Number: 298001007_1_1
 Customer Ref: 21-1098.04
 National Grid Reference: 483820, 381060
 Slice: E
 Site Area (Ha): 471.82
 Search Buffer (m): 100

Site Details

West Barton 1

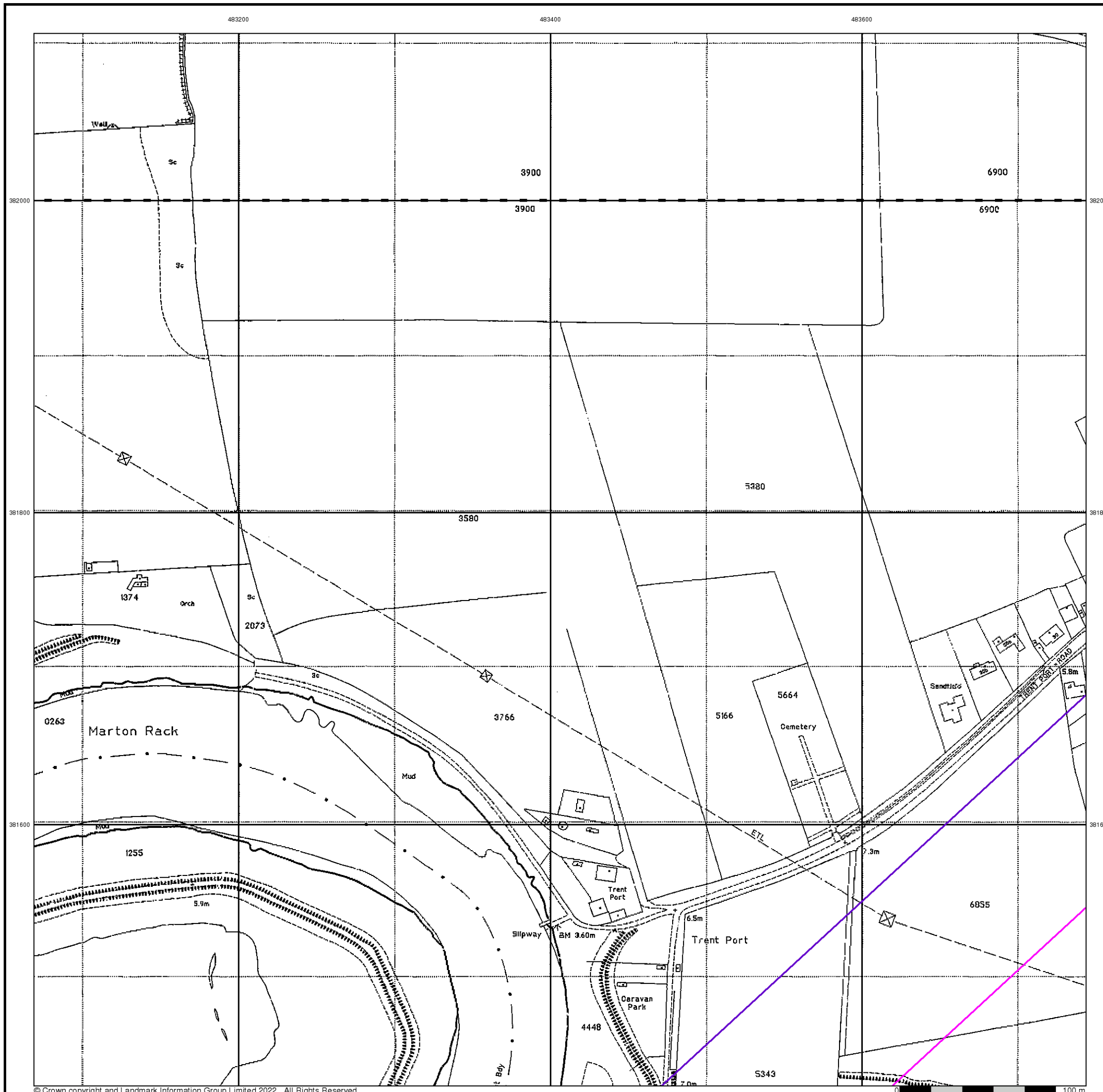

Historical Mapping Legends

Ordnance Survey County Series and Ordnance Survey Plan 1:2,500

Quarry **Gravel Pit** **Sand Pit**
Clay Pit **Shingle** **Refuse Heap**
Sloping Masonry **Flat Rock**
Marsh **Reeds** **Osiers**
Rough Pasture **Furze** **Wood**
Mixed Wood **Brushwood** **Orchard**
Fir **Ford** **Stepping Stones**
Ferry **Waterfall** **Lock**
Trig. Station **Altitude at Trig. Station**
B.M. 325.9 **Bench Mark** **Surface Level**
Arrow denotes flow of water **Antiquities (site of)**
Cutting **Embankment**
Railway crossing Road **Level Crossing** **Road crossing Railway**
Railway crossing River or Canal **Road over single stream** **Road over River or Canal**
County Boundary (Geographical)
County & Civil Parish Boundary
Administrative County & Civil Parish Boundary
County Borough Boundary (England)
County Burgh Boundary (Scotland)
Co. Boro. Bdy.
Co. Burgh Bdy.
BP BS Boundary Post or Stone **P.C.B** Police Call Box
B.R. Bridle Road **P** Pump
E.P Electricity Pylon **S.P** Signal Post
F.B. Foot Bridge **SL** Sluice
F.P. Foot Path **Sp.** Spring
G.P Guide Post or Board **T.C.B** Telephone Call Box
M.S Mile Stone **Tr.** Trough
M.P M.R Mooring Post or Ring **W** Well

Ordnance Survey Plan, Additional SIMs and Supply of Unpublished Survey Information 1:2,500 and 1:1,250

Inactive Quarry, Chalk Pit or Clay Pit **Active Quarry, Chalk Pit or Clay Pit**
Rock **Boulders**
Cliff **Slopes** **Top**
Roofed Building **Glazed Roof Building**
Sloping Masonry **Archway**
Non-Coniferous Tree (surveyed) **Coniferous Tree (surveyed)**
Non-Coniferous Trees (not surveyed) **Coniferous Trees (not surveyed)**
Orchard Tree **Scrub** **Bracken**
Coppice, Osier **Reeds** **Marsh, Saltings**
Rough Grassland **Heath** **Culvert**
Direction of water flow **Bench Mark** **Antiquity (site of)**
Cave Entrance **Triangulation Station** **Electricity Pylon**
Electricity Transmission Line
County Boundary (Geographical)
County & Civil Parish Boundary
Civil Parish Boundary
Admin. County or County Bor. Boundary
London Borough Boundary
Symbol marking point where boundary mereing changes
BH Beer House **P** Pillar, Pole or Post
BP, BS Boundary Post or Stone **PO** Post Office
Cn, C Capstan, Crane **PC** Public Convenience
Chy Chimney **PH** Public House
D Fn Drinking Fountain **Pp** Pump
EI P Electricity Pillar or Post **SB, S Br** Signal Box or Bridge
FAP Fire Alarm Pillar **SP, SL** Signal Post or Light
FB Foot Bridge **Spr** Spring
GP Guide Post **Tk** Tank or Track
H Hydrant or Hydraulic **TCB** Telephone Call Box
LC Level Crossing **TCP** Telephone Call Post
MH Manhole **Tr** Trough
MP Mile Post or Mooring Post **Wr Pt, Wr T** Water Point, Water Tap
MS Mile Stone **W** Well
NTL Normal Tidal Limit **Wd Pp** Wind Pump

Large-Scale National Grid Data 1:2,500 and 1:1,250

Cliff **Slopes** **Top**
Rock **Rock (scattered)**
Boulders **Boulders (scattered)**
Positioned Boulder **Scree**
Non-Coniferous Tree (surveyed) **Coniferous Tree (surveyed)**
Non-Coniferous Trees (not surveyed) **Coniferous Trees (not surveyed)**
Orchard Tree **Scrub** **Bracken**
Coppice, Osier **Reeds** **Marsh, Saltings**
Rough Grassland **Heath** **Culvert**
Direction of water flow **Triangulation Station** **Antiquity (site of)**
Electricity Transmission Line **Electricity Pylon**
BM 231.60m Bench Mark **Buildings with Building Seed**
Roofed Building **Glazed Roof Building**
Civil parish/community boundary
District boundary
County boundary
Boundary post/stone
Boundary mereing symbol (note: these always appear in opposed pairs or groups of three)
Bks Barracks **P** Pillar, Pole or Post
Bty Battery **PO** Post Office
Cemy Cemetery **PC** Public Convenience
Chy Chimney **Pp** Pump
Cis Cistern **Ppg Sta** Pumping Station
Dismtd Rly Dismantled Railway **PW** Place of Worship
EI Gen Sta Electricity Generating Station **Sewage Ppg Sta** Sewage Pumping Station
EI P Electricity Pole, Pillar **SB, S Br** Signal Box or Bridge
EI Sub Sta Electricity Sub Station **SP, SL** Signal Post or Light
FB Filter Bed **Spr** Spring
Fn / D Fn Fountain / Drinking Ftn. **Tk** Tank or Track
Gas Gov Gas Valve Compound **Tr** Trough
GVC Gas Governor **Wd Pp** Wind Pump
GP Guide Post **Wr Pt, Wr T** Water Point, Water Tap
MH Manhole **Wks** Works (building or area)
MP, MS Mile Post or Mile Stone **W** Well

Historical Mapping & Photography included:

Mapping Type	Scale	Date	Pg
Lincolnshire	1:2,500	1886	2
Nottinghamshire	1:2,500	1899	3
Lincolnshire	1:2,500	1920	4
Ordnance Survey Plan	1:2,500	1974 - 1975	5
Additional SIMs	1:2,500	1993	6
Large-Scale National Grid Data	1:2,500	1994	7

Historical Map - Segment E15

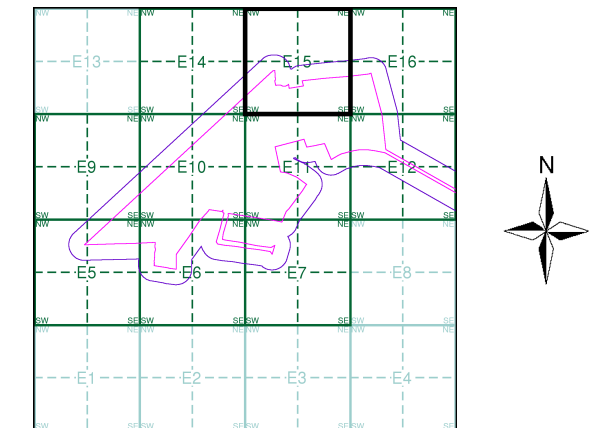

Order Details

Order Number: 298001007_1_1
 Customer Ref: 21-1098.04
 National Grid Reference: 483820, 381060
 Slice: E
 Site Area (Ha): 471.82
 Search Buffer (m): 100

Site Details

West Barton 1

Lincolnshire

Published 1886

Source map scale - 1:2,500

The historical maps shown were reproduced from maps predominantly held at the scale adopted for England, Wales and Scotland in the 1840's. In 1854 the 1:2,500 scale was adopted for mapping urban areas and by 1896 it covered the whole of what were considered to be the cultivated parts of Great Britain. The published date given below is often some years later than the surveyed date. Before 1938, all OS maps were based on the Cassini Projection, with independent surveys of a single county or group of counties, giving rise to significant inaccuracies in outlying areas.

Map Name(s) and Date(s)

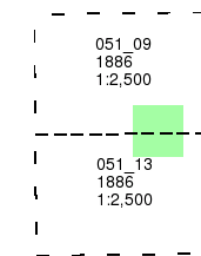

Historical Map - Segment E15

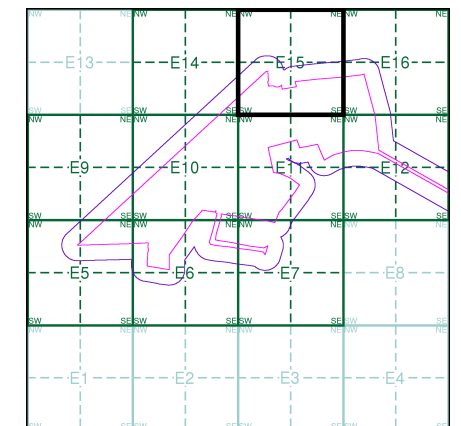

Order Details

Order Number: 298001007_1_1
 Customer Ref: 21-1098.04
 National Grid Reference: 483820, 381060
 Slice: E
 Site Area (Ha): 471.82
 Search Buffer (m): 100

Site Details

West Barton 1

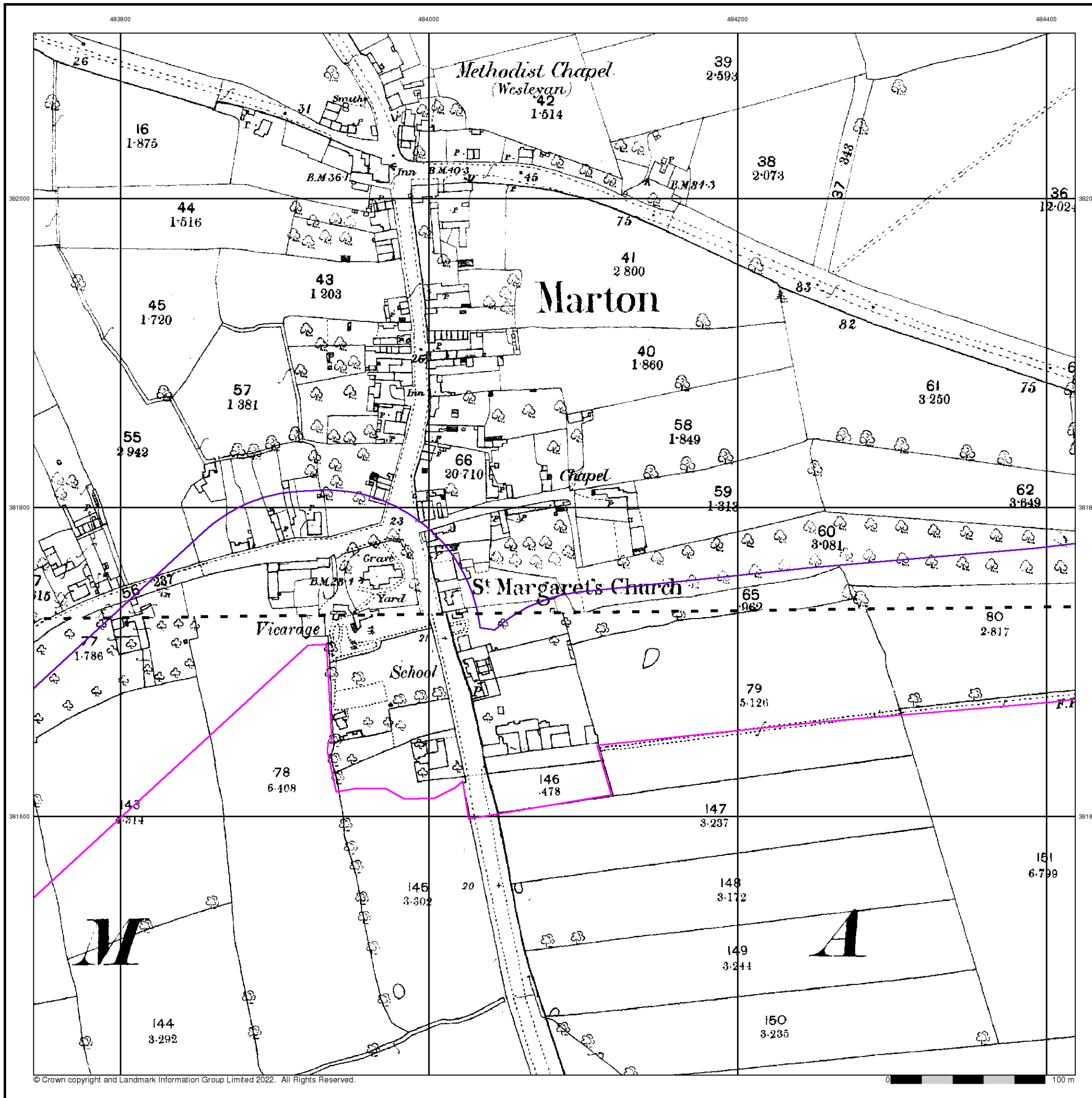

Nottinghamshire

Published 1899

Source map scale - 1:2,500

The historical maps shown were reproduced from maps predominantly held at the scale adopted for England, Wales and Scotland in the 1840's. In 1854 the 1:2,500 scale was adopted for mapping urban areas and by 1896 it covered the whole of what were considered to be the cultivated parts of Great Britain. The published date given below is often some years later than the surveyed date. Before 1938, all OS maps were based on the Cassini Projection, with independent surveys of a single county or group of counties, giving rise to significant inaccuracies in outlying areas.

Map Name(s) and Date(s)

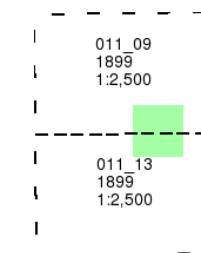

Historical Map - Segment E15

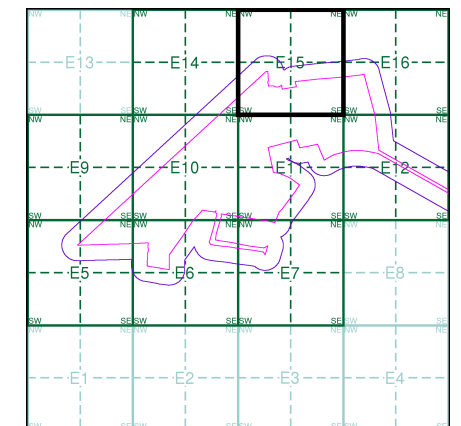

Order Details

Order Number: 298001007_1_1
 Customer Ref: 21-1098.04
 National Grid Reference: 483820, 381060
 Slice: E
 Site Area (Ha): 471.82
 Search Buffer (m): 100

Site Details

West Barton 1

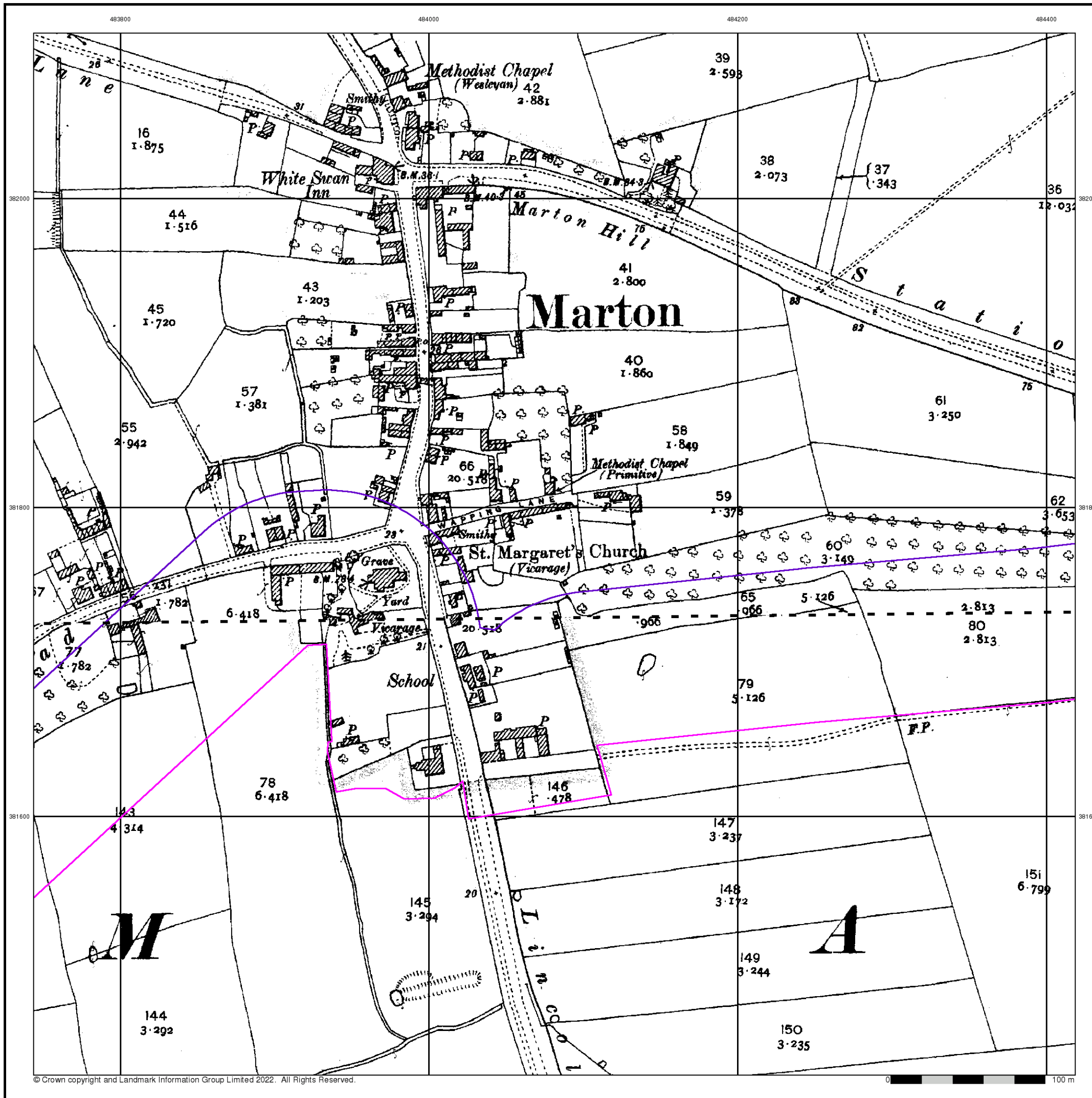

Lincolnshire

Published 1920

Source map scale - 1:2,500

The historical maps shown were reproduced from maps predominantly held at the scale adopted for England, Wales and Scotland in the 1840's. In 1854 the 1:2,500 scale was adopted for mapping urban areas and by 1896 it covered the whole of what were considered to be the cultivated parts of Great Britain. The published date given below is often some years later than the surveyed date. Before 1938, all OS maps were based on the Cassini Projection, with independent surveys of a single county or group of counties, giving rise to significant inaccuracies in outlying areas.

Map Name(s) and Date(s)

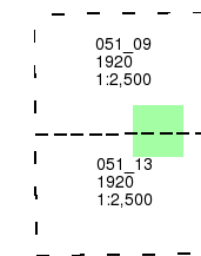

Historical Map - Segment E15

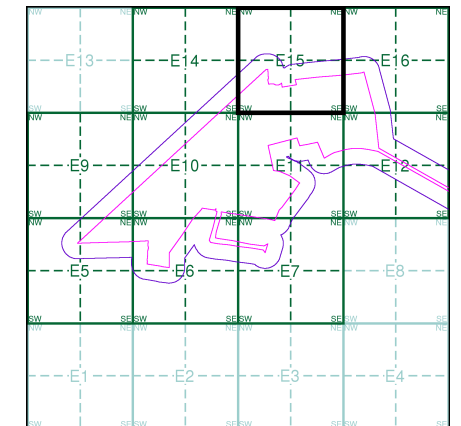

Order Details

Order Number: 298001007_1_1
 Customer Ref: 21-1098.04
 National Grid Reference: 483820, 381060
 Slice: E
 Site Area (Ha): 471.82
 Search Buffer (m): 100

Site Details

West Barton 1

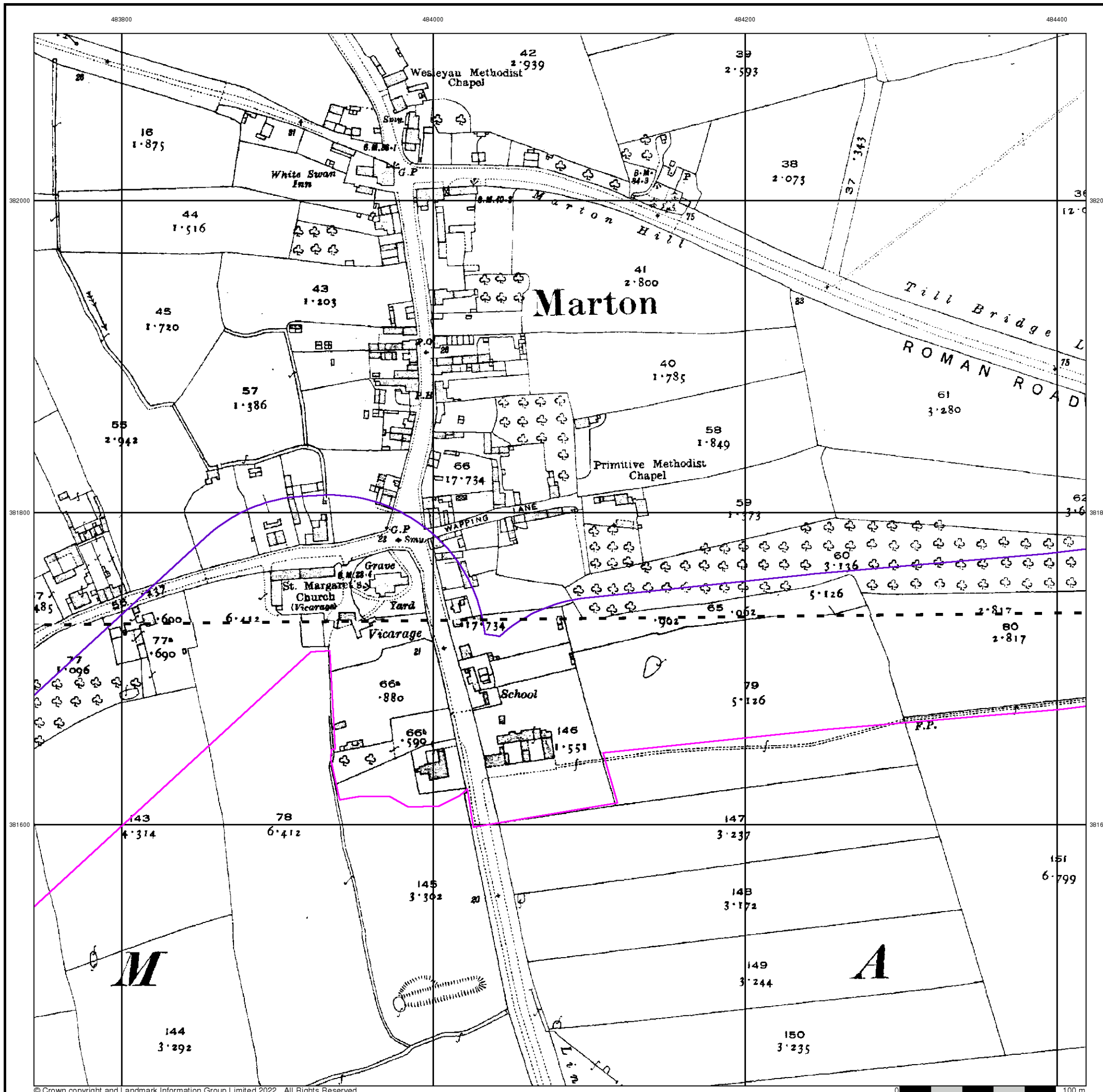

Ordnance Survey Plan
Published 1974 - 1975
Source map scale - 1:2,500

The historical maps shown were reproduced from maps predominantly held at the scale adopted for England, Wales and Scotland in the 1840's. In 1854 the 1:2,500 scale was adopted for mapping urban areas and by 1896 it covered the whole of what were considered to be the cultivated parts of Great Britain. The published date given below is often some years later than the surveyed date. Before 1938, all OS maps were based on the Cassini Projection, with independent surveys of a single county or group of counties, giving rise to significant inaccuracies in outlying areas.

Map Name(s) and Date(s)

SK8382 1975 12,500	SK8482 1975 12,500
SK8381 1975 12,500	SK8481 1974 12,500

Historical Map - Segment E15

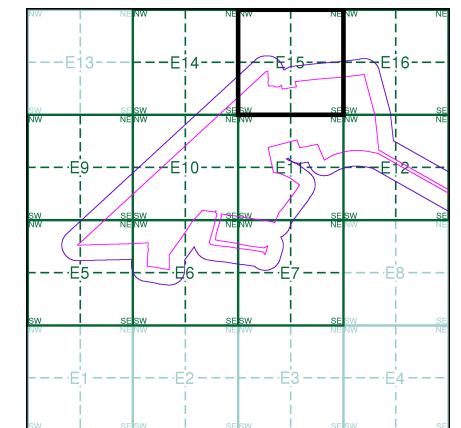

Order Details

Order Number: 298001007_1_1
 Customer Ref: 21-1098.04
 National Grid Reference: 483820, 381060
 Slice: E
 Site Area (Ha): 471.82
 Search Buffer (m): 100

Site Details

West Barton 1

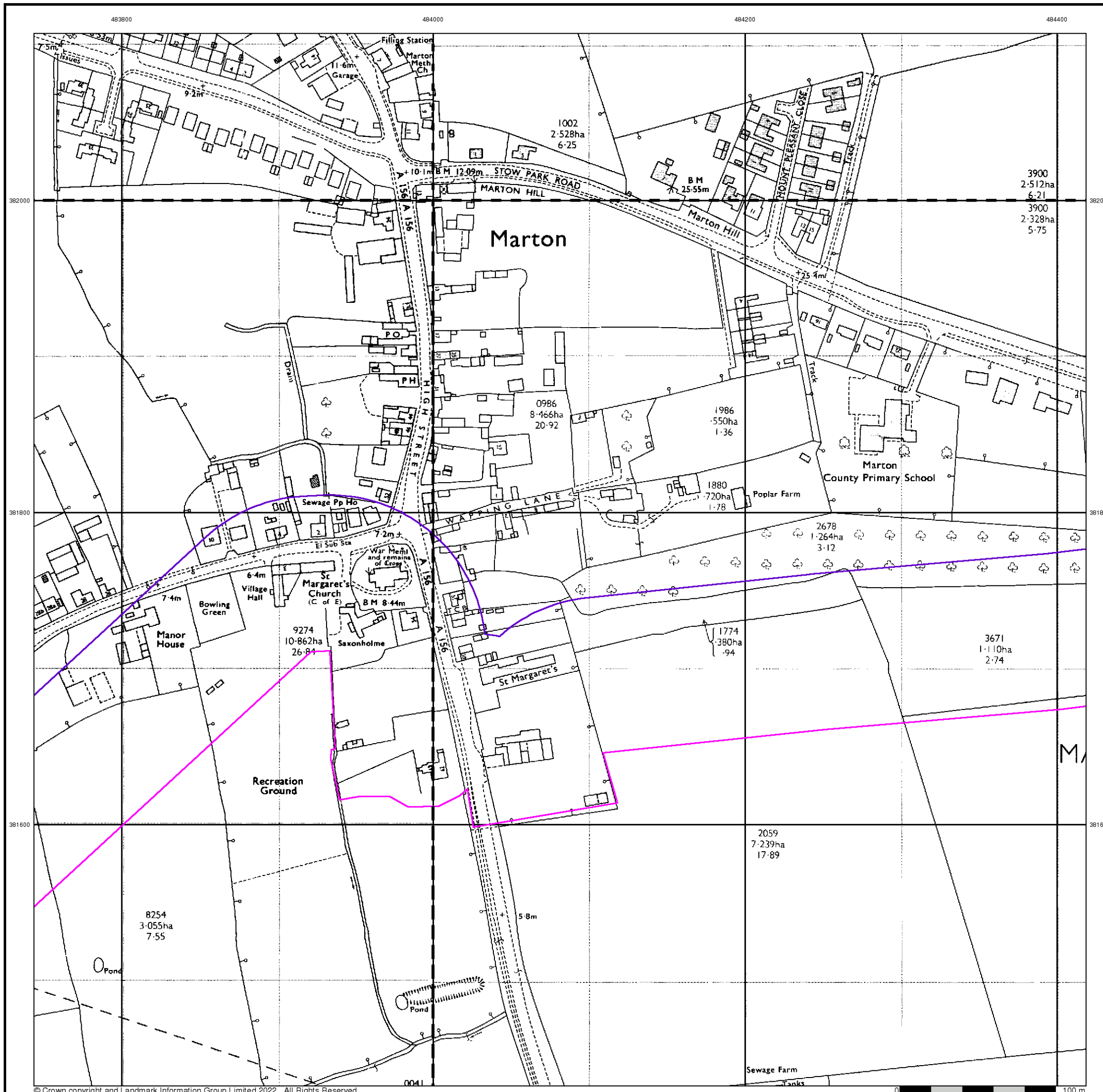

Additional SIMs

Published 1993

Source map scale - 1:2,500

The SIM cards (Ordnance Survey's 'Survey of Information on Microfilm') are further, minor editions of mapping which were produced and published in between the main editions as an area was updated. They date from 1947 to 1994, and contain detailed information on buildings, roads and land-use. These maps were produced at both 1:2,500 and 1:1,250 scales.

Map Name(s) and Date(s)

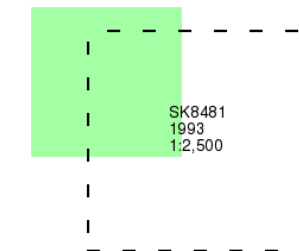

Historical Map - Segment E15

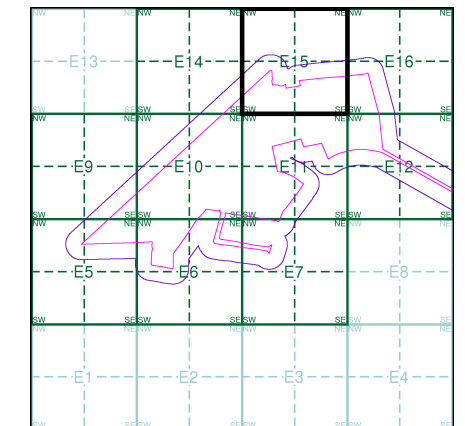

Order Details

Order Number: 298001007_1_1
 Customer Ref: 21-1098.04
 National Grid Reference: 483820, 381060
 Slice: E
 Site Area (Ha): 471.82
 Search Buffer (m): 100

Site Details

West Barton 1

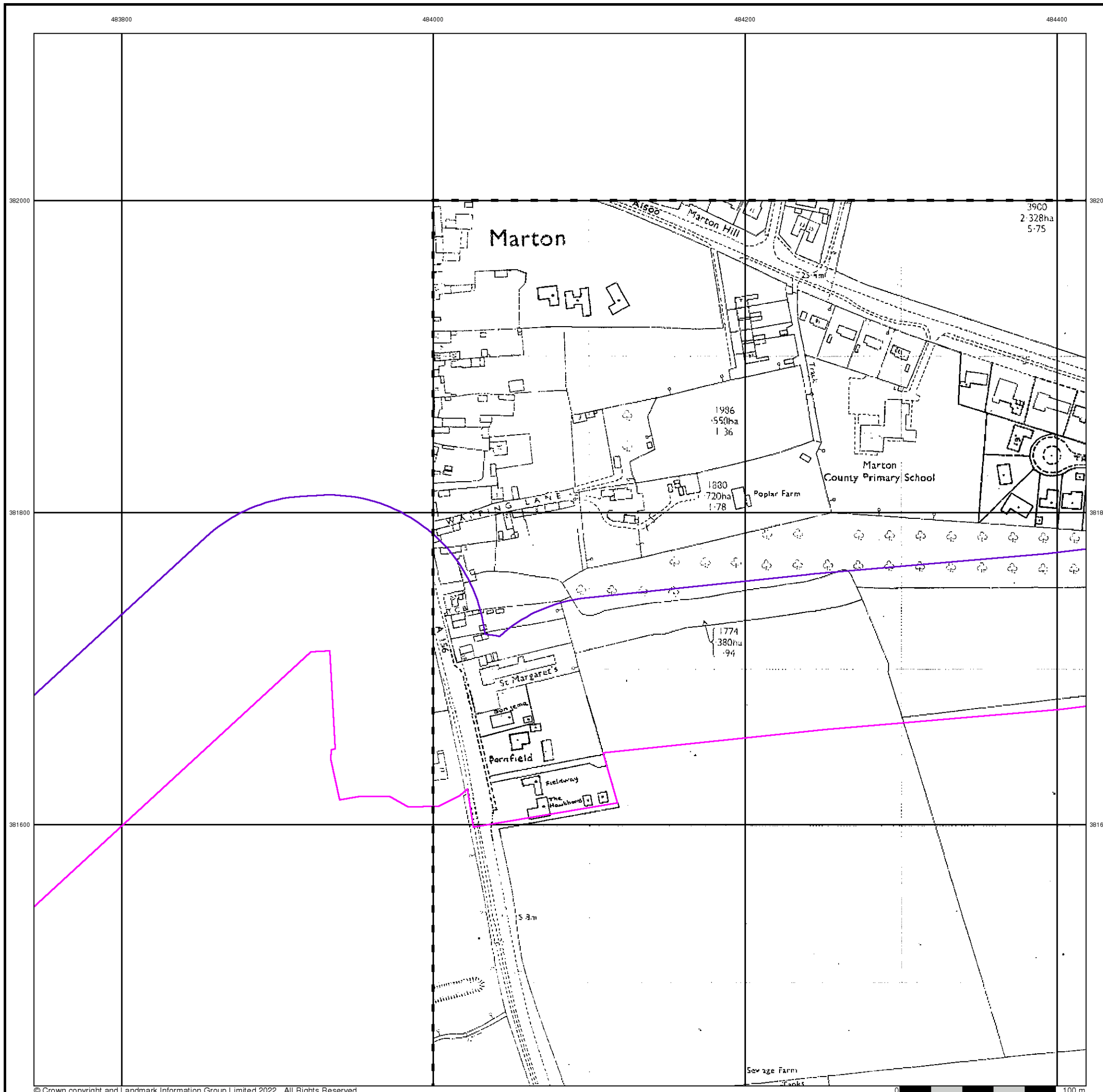

Large-Scale National Grid Data
Published 1994
Source map scale - 1:2,500

'Large Scale National Grid Data' superseded SIM cards (Ordnance Survey's 'Survey of Information on Microfilm') in 1992, and continued to be produced until 1999. These maps were the fore-runners of digital mapping and so provide detailed information on houses and roads, but tend to show less topographic features such as vegetation. These maps were produced at both 1:2,500 and 1:1,250 scales.

Map Name(s) and Date(s)

SK8382	SK8482
1994	1994
12,500	12,500
SK8381	SK8481
1994	1994
12,500	12,500

Historical Map - Segment E15

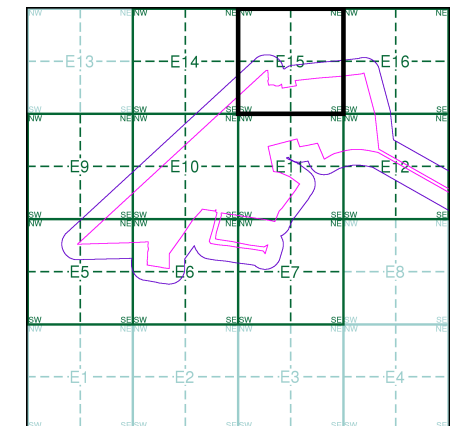

Order Details

Order Number: 298001007_1_1
 Customer Ref: 21-1098.04
 National Grid Reference: 483820, 381060
 Slice: E
 Site Area (Ha): 471.82
 Search Buffer (m): 100

Site Details

West Barton 1

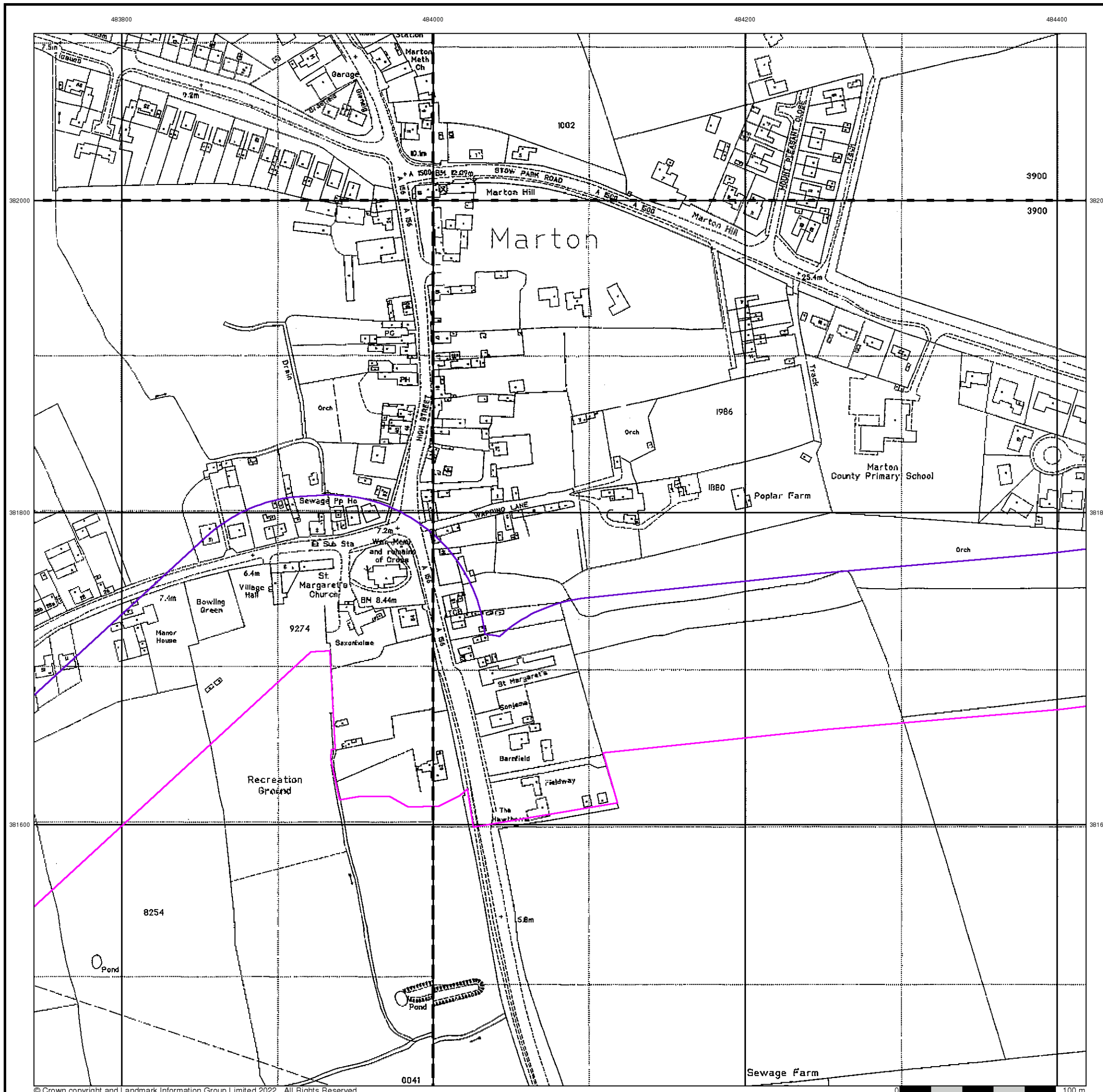

Historical Mapping Legends

Ordnance Survey County Series and Ordnance Survey Plan 1:2,500

Quarry **Gravel Pit** **Sand Pit**
Clay Pit **Shingle** **Refuse Heap**
Sloping Masonry **Flat Rock**
Marsh **Reeds** **Osiers**
Rough Pasture **Furze** **Wood**
Mixed Wood **Brushwood** **Orchard**
Fir **Ford** **Stepping Stones**
Ferry **Waterfall** **Lock**
Trig. Station **Altitude at Trig. Station**
B.M. 325.9 **Bench Mark** **Surface Level**
Arrow denotes flow of water **Antiquities (site of)**
Cutting **Embankment**
Railway crossing Road **Level Crossing** **Road crossing Railway**
Railway crossing River or Canal **Road over single stream** **Road over River or Canal**
County Boundary (Geographical)
County & Civil Parish Boundary
Administrative County & Civil Parish Boundary
County Borough Boundary (England)
County Burgh Boundary (Scotland)
Boundary Post or Stone **Police Call Box**
B.R. Bridle Road **Pump**
E.P. Electricity Pylon **S.P. Signal Post**
F.B. Foot Bridge **Sl. Sluice**
F.P. Foot Path **Sp. Spring**
G.P. Guide Post or Board **T.C.B. Telephone Call Box**
M.S. Mile Stone **Tr. Trough**
M.P. M.R. Mooring Post or Ring **W. Well**

Ordnance Survey Plan, Additional SIMs and Supply of Unpublished Survey Information 1:2,500 and 1:1,250

Inactive Quarry, Chalk Pit or Clay Pit **Active Quarry, Chalk Pit or Clay Pit**
Rock **Boulders**
Cliff **Slopes** **Top**
Roofed Building **Glazed Roof Building**
Sloping Masonry **Archway**
Non-Coniferous Tree (surveyed) **Coniferous Tree (surveyed)**
Non-Coniferous Trees (not surveyed) **Coniferous Trees (not surveyed)**
Orchard Tree **Scrub** **Bracken**
Coppice, Osier **Reeds** **Marsh, Saltings**
Rough Grassland **Heath** **Culvert**
Direction of water flow **Bench Mark** **Antiquity (site of)**
Cave Entrance **Triangulation Station** **Electricity Pylon**
Electricity Transmission Line
County Boundary (Geographical)
County & Civil Parish Boundary
Civil Parish Boundary
Admin. County or County Bor. Boundary
London Borough Boundary
Symbol marking point where boundary mereing changes
BH Beer House **P Pillar, Pole or Post**
BP, BS Boundary Post or Stone **PO Post Office**
Cn, C Capstan, Crane **PC Public Convenience**
Chy Chimney **PH Public House**
D Fn Drinking Fountain **Pp Pump**
EI P Electricity Pillar or Post **SB, S Br Signal Box or Bridge**
FAP Fire Alarm Pillar **SP, SL Signal Post or Light**
FB Foot Bridge **Spr Spring**
GP Guide Post **Tk Tank or Track**
H Hydrant or Hydraulic **TCB Telephone Call Box**
LC Level Crossing **TCP Telephone Call Post**
MH Manhole **Tr Trough**
MP Mile Post or Mooring Post **Wr Pt, Wr T Water Point, Water Tap**
MS Mile Stone **W Well**
NTL Normal Tidal Limit **Wd Pp Wind Pump**

Large-Scale National Grid Data 1:2,500 and 1:1,250

Cliff **Slopes** **Top**
Rock **Rock (scattered)**
Boulders **Boulders (scattered)**
Positioned Boulder **Scree**
Non-Coniferous Tree (surveyed) **Coniferous Tree (surveyed)**
Non-Coniferous Trees (not surveyed) **Coniferous Trees (not surveyed)**
Orchard Tree **Scrub** **Bracken**
Coppice, Osier **Reeds** **Marsh, Saltings**
Rough Grassland **Heath** **Culvert**
Direction of water flow **Triangulation Station** **Antiquity (site of)**
Electricity Transmission Line **Electricity Pylon**
B.M. 231.60m Bench Mark **Buildings with Building Seed**
Roofed Building **Glazed Roof Building**
Civil parish/community boundary
District boundary
County boundary
Boundary post/stone
Boundary mereing symbol (note: these always appear in opposed pairs or groups of three)
Bks Barracks **P Pillar, Pole or Post**
Bty Battery **PO Post Office**
Cemy Cemetery **PC Public Convenience**
Chy Chimney **Pp Pump**
Cis Cistern **Ppg Sta Pumping Station**
Dismtd Rly Dismantled Railway **PW Place of Worship**
EI Gen Sta Electricity Generating Station **Sewage Ppg Sta Sewage Pumping Station**
EI P Electricity Pole, Pillar **SB, S Br Signal Box or Bridge**
EI Sub Sta Electricity Sub Station **SP, SL Signal Post or Light**
FB Filter Bed **Spr Spring**
Fn / D Fn Fountain / Drinking Ftn. **Tk Tank or Track**
Gas Gov Gas Valve Compound **Tr Trough**
GVC Gas Governor **Wd Pp Wind Pump**
GP Guide Post **Wr Pt, Wr T Water Point, Water Tap**
MH Manhole **Wks Works (building or area)**
MP, MS Mile Post or Mile Stone **W Well**



Historical Mapping & Photography included:

Mapping Type	Scale	Date	Pg
Lincolnshire	1:2,500	1886	2
Nottinghamshire	1:2,500	1899	3
Lincolnshire	1:2,500	1906	4
Lincolnshire	1:2,500	1920	5
Ordnance Survey Plan	1:2,500	1974 - 1975	6
Additional SIMs	1:2,500	1993	7
Large-Scale National Grid Data	1:2,500	1994	8

Historical Map - Segment E16

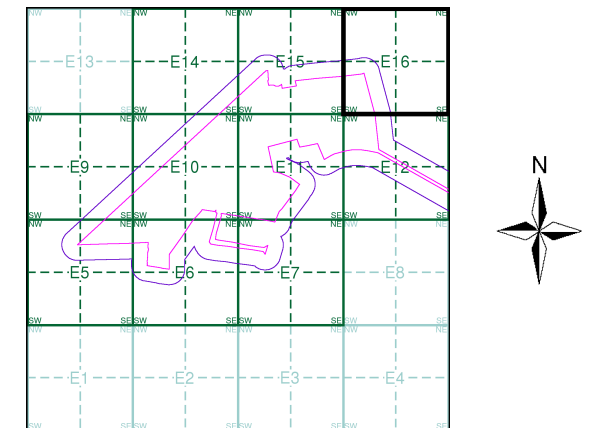

Order Details

Order Number: 298001007_1_1
 Customer Ref: 21-1098.04
 National Grid Reference: 483820, 381060
 Slice: E
 Site Area (Ha): 471.82
 Search Buffer (m): 100

Site Details

West Barton 1



Tel: 0844 844 9952
 Fax: 0844 844 9951
 Web: [REDACTED]

Lincolnshire

Published 1886

Source map scale - 1:2,500

The historical maps shown were reproduced from maps predominantly held at the scale adopted for England, Wales and Scotland in the 1840's. In 1854 the 1:2,500 scale was adopted for mapping urban areas and by 1896 it covered the whole of what were considered to be the cultivated parts of Great Britain. The published date given below is often some years later than the surveyed date. Before 1938, all OS maps were based on the Cassini Projection, with independent surveys of a single county or group of counties, giving rise to significant inaccuracies in outlying areas.

Map Name(s) and Date(s)

051_09 1886 1:2,500	051_10 1886 1:2,500
051_13 1886 1:2,500	051_14 1886 1:2,500

Historical Map - Segment E16

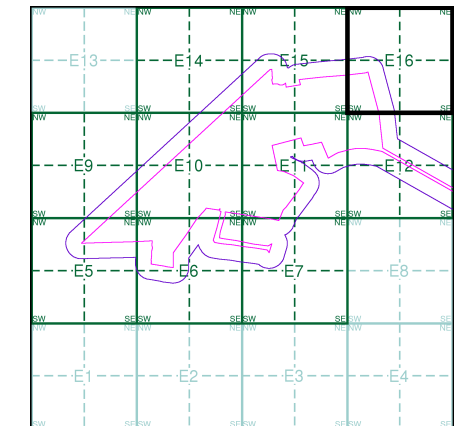

Order Details

Order Number: 298001007_1_1
 Customer Ref: 21-1098.04
 National Grid Reference: 483820, 381060
 Slice: E
 Site Area (Ha): 471.82
 Search Buffer (m): 100

Site Details

West Barton 1

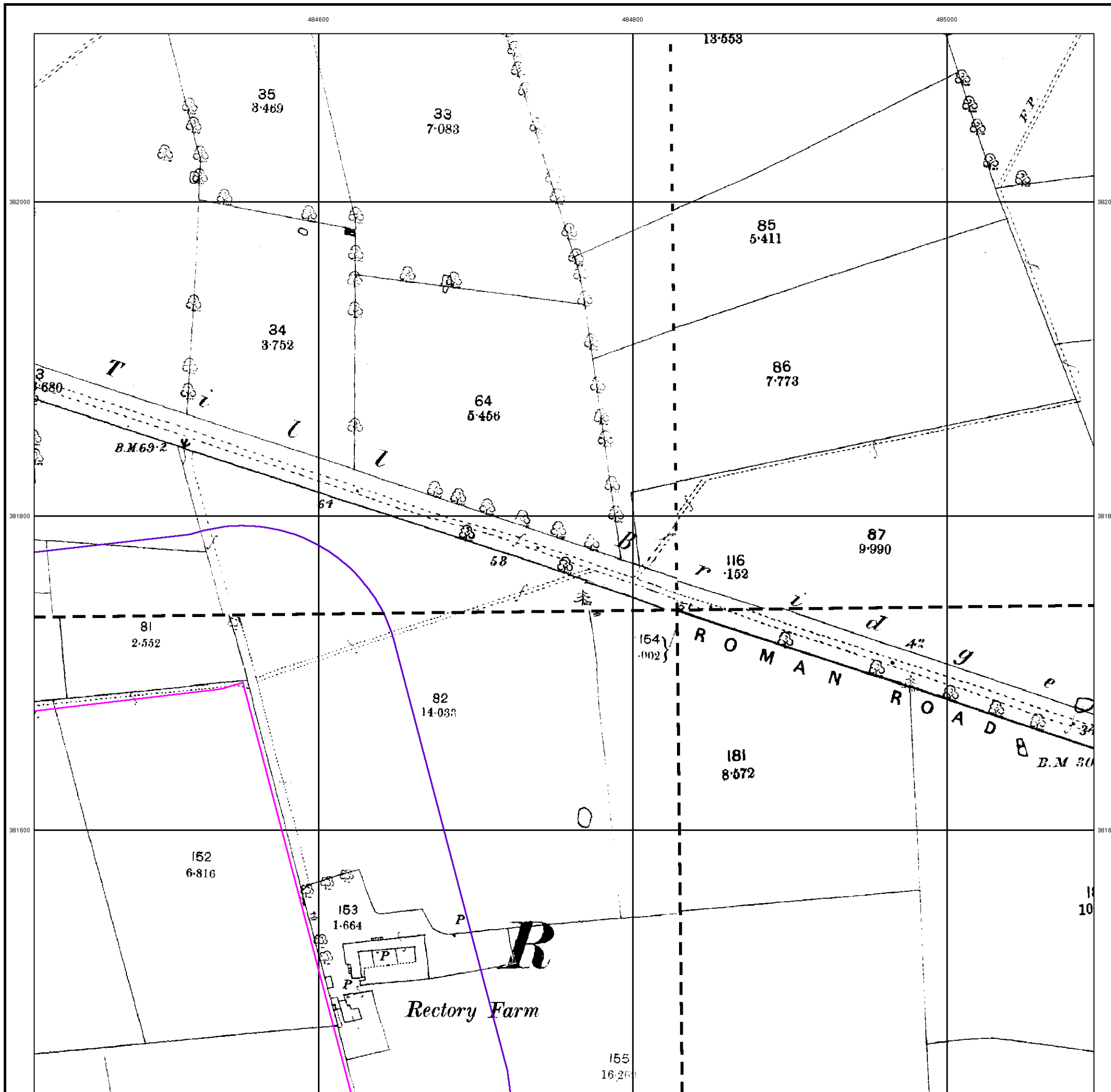

Nottinghamshire

Published 1899

Source map scale - 1:2,500

The historical maps shown were reproduced from maps predominantly held at the scale adopted for England, Wales and Scotland in the 1840's. In 1854 the 1:2,500 scale was adopted for mapping urban areas and by 1896 it covered the whole of what were considered to be the cultivated parts of Great Britain. The published date given below is often some years later than the surveyed date. Before 1938, all OS maps were based on the Cassini Projection, with independent surveys of a single county or group of counties, giving rise to significant inaccuracies in outlying areas.

Map Name(s) and Date(s)

011_09 1899 12,500	
011_13 1899 12,500	

Historical Map - Segment E16

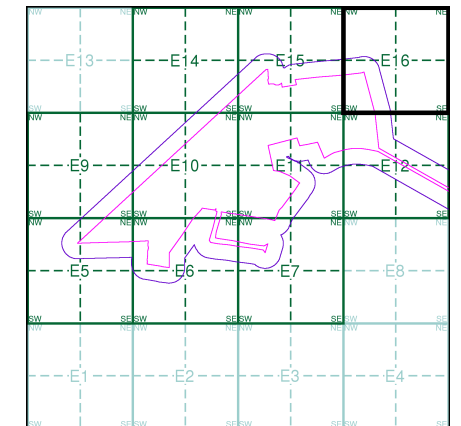

Order Details

Order Number: 298001007_1_1
 Customer Ref: 21-1098.04
 National Grid Reference: 483820, 381060
 Slice: E
 Site Area (Ha): 471.82
 Search Buffer (m): 100

Site Details

West Barton 1

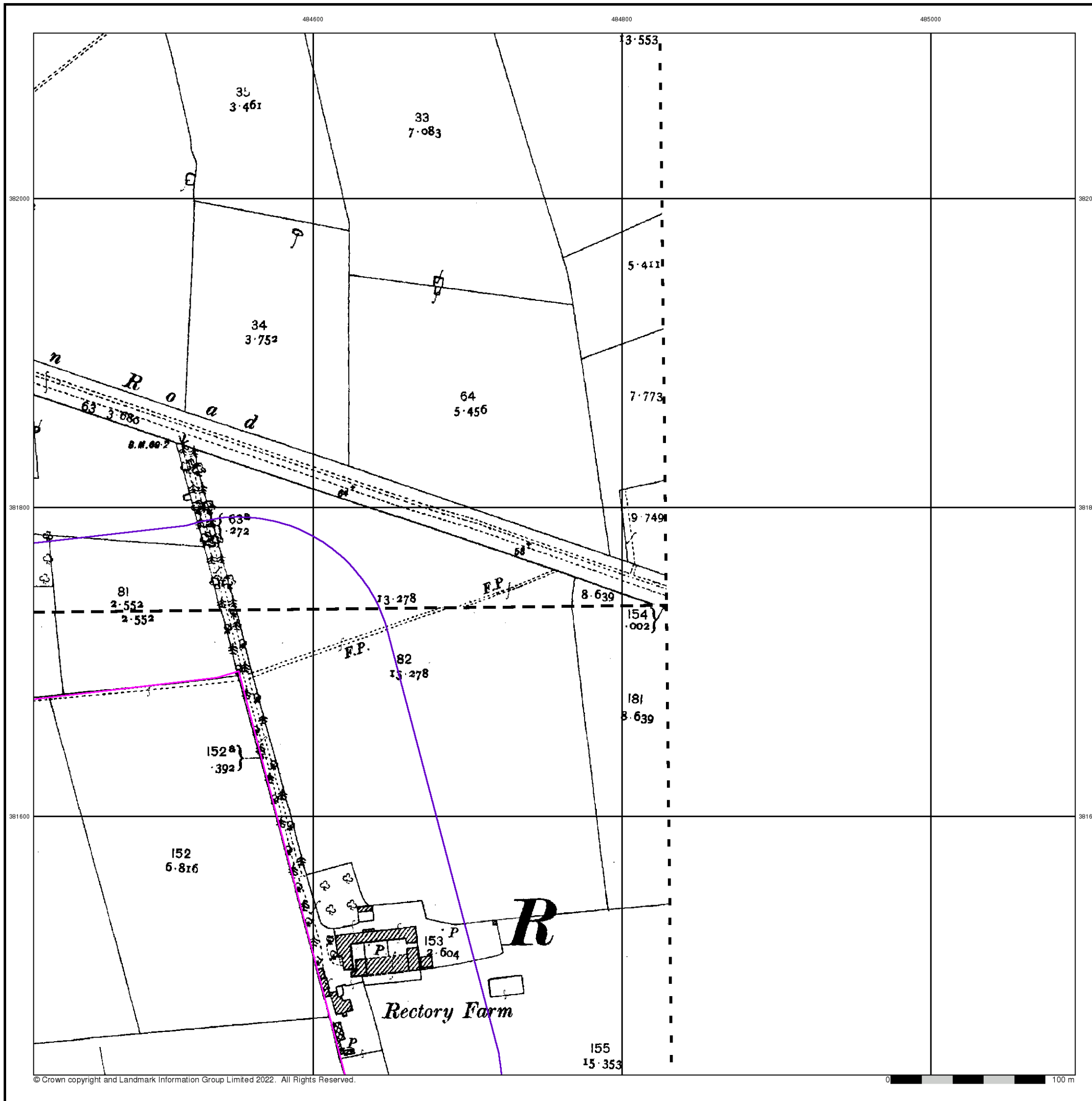

Lincolnshire

Published 1906

Source map scale - 1:2,500

The historical maps shown were reproduced from maps predominantly held at the scale adopted for England, Wales and Scotland in the 1840's. In 1854 the 1:2,500 scale was adopted for mapping urban areas and by 1896 it covered the whole of what were considered to be the cultivated parts of Great Britain. The published date given below is often some years later than the surveyed date. Before 1938, all OS maps were based on the Cassini Projection, with independent surveys of a single county or group of counties, giving rise to significant inaccuracies in outlying areas.

Map Name(s) and Date(s)

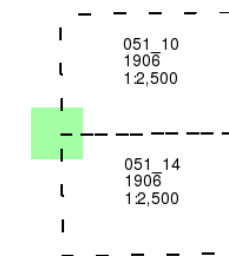

Historical Map - Segment E16

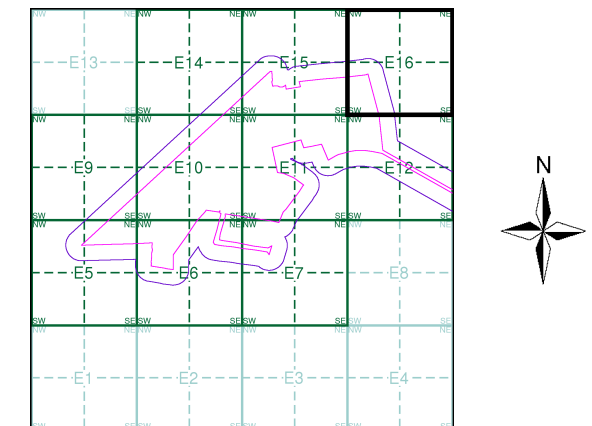

Order Details

Order Number: 298001007_1_1
 Customer Ref: 21-1098.04
 National Grid Reference: 483820, 381060
 Slice: E
 Site Area (Ha): 471.82
 Search Buffer (m): 100

Site Details

West Barton 1

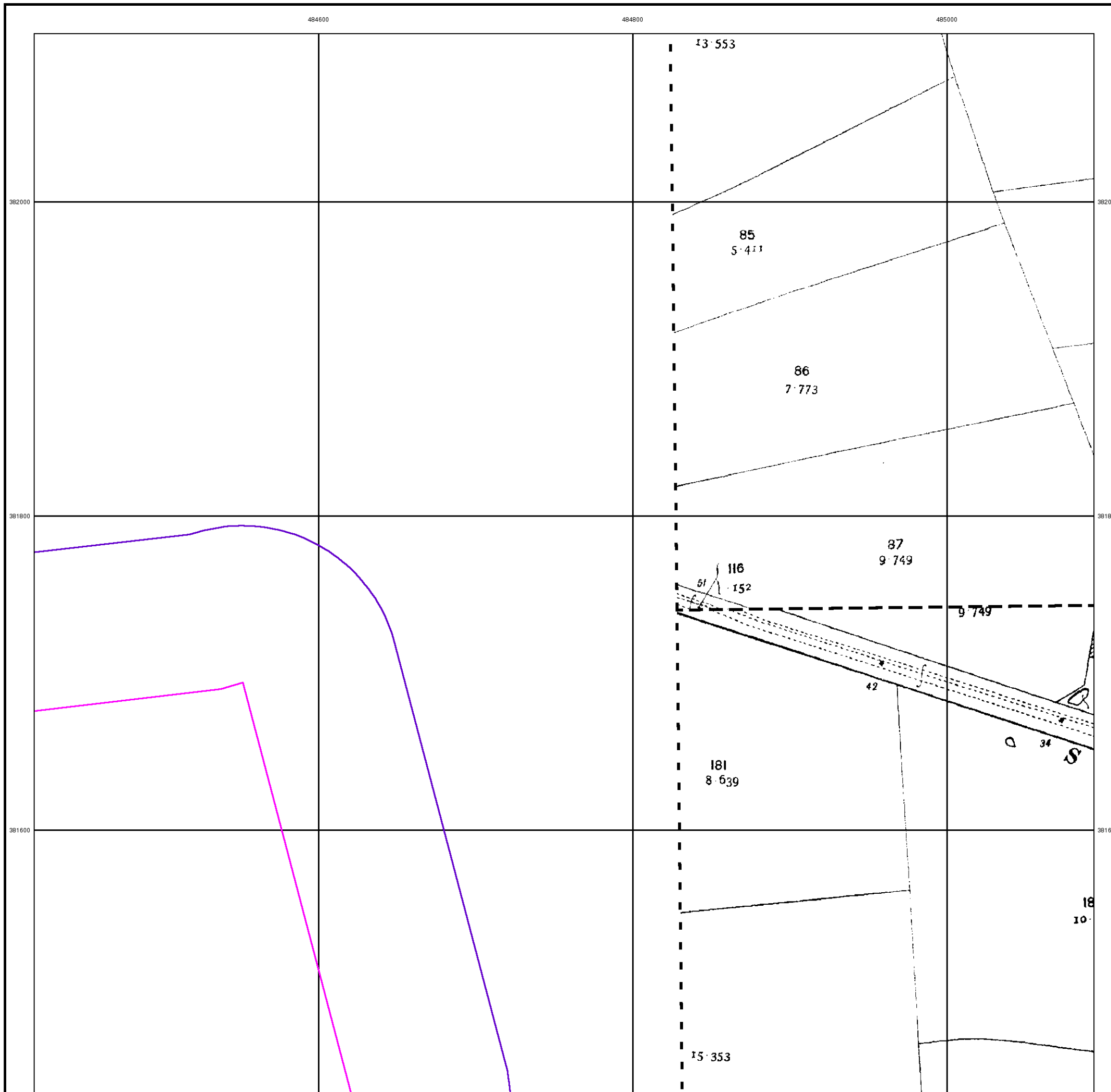

Lincolnshire

Published 1920

Source map scale - 1:2,500

The historical maps shown were reproduced from maps predominantly held at the scale adopted for England, Wales and Scotland in the 1840's. In 1854 the 1:2,500 scale was adopted for mapping urban areas and by 1896 it covered the whole of what were considered to be the cultivated parts of Great Britain. The published date given below is often some years later than the surveyed date. Before 1938, all OS maps were based on the Cassini Projection, with independent surveys of a single county or group of counties, giving rise to significant inaccuracies in outlying areas.

Map Name(s) and Date(s)

051_09 1920 1:2,500	051_10 1920 1:2,500
051_13 1920 1:2,500	051_14 1920 1:2,500

Historical Map - Segment E16

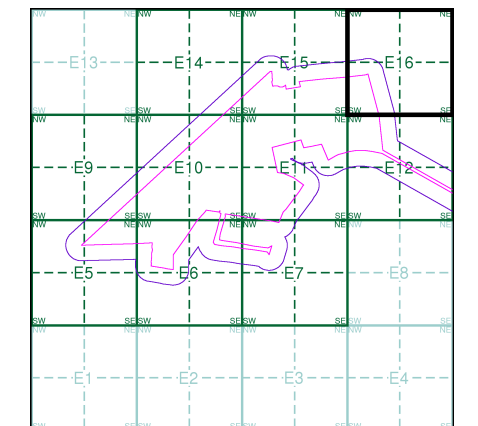

Order Details

Order Number: 298001007_1_1
 Customer Ref: 21-1098.04
 National Grid Reference: 483820, 381060
 Slice: E
 Site Area (Ha): 471.82
 Search Buffer (m): 100

Site Details

West Barton 1

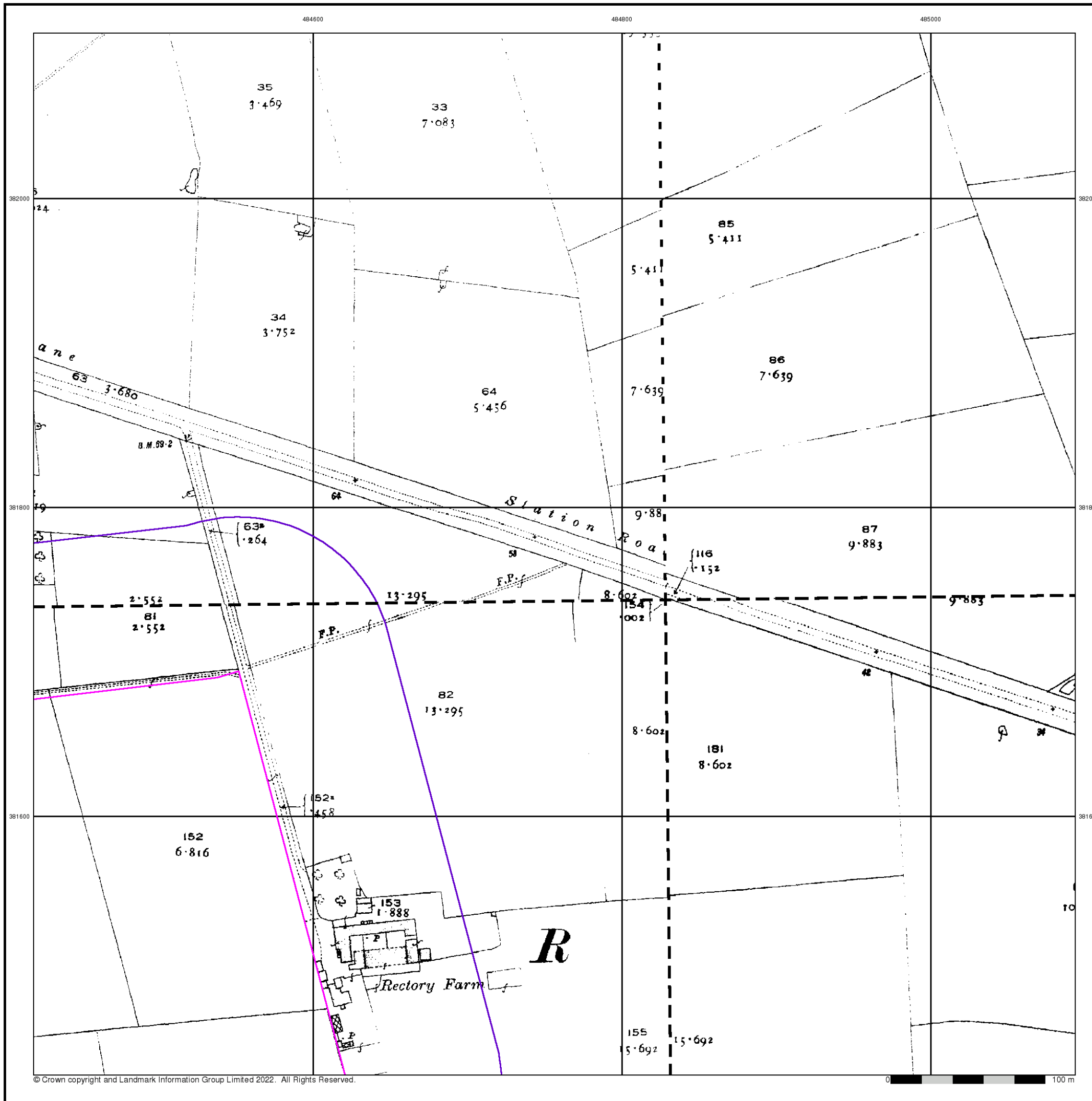

Ordnance Survey Plan
Published 1974 - 1975
Source map scale - 1:2,500

The historical maps shown were reproduced from maps predominantly held at the scale adopted for England, Wales and Scotland in the 1840's. In 1854 the 1:2,500 scale was adopted for mapping urban areas and by 1896 it covered the whole of what were considered to be the cultivated parts of Great Britain. The published date given below is often some years later than the surveyed date. Before 1938, all OS maps were based on the Cassini Projection, with independent surveys of a single county or group of counties, giving rise to significant inaccuracies in outlying areas.

Map Name(s) and Date(s)

SK8482 1975 1:2,500	SK8582 1975 1:2,500
SK8481 1974 1:2,500	SK8581 1974 1:2,500

Historical Map - Segment E16

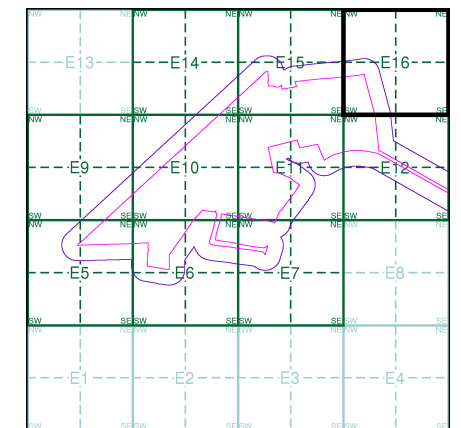

Order Details

Order Number: 298001007_1_1
 Customer Ref: 21-1098.04
 National Grid Reference: 483820, 381060
 Slice: E
 Site Area (Ha): 471.82
 Search Buffer (m): 100

Site Details

West Barton 1

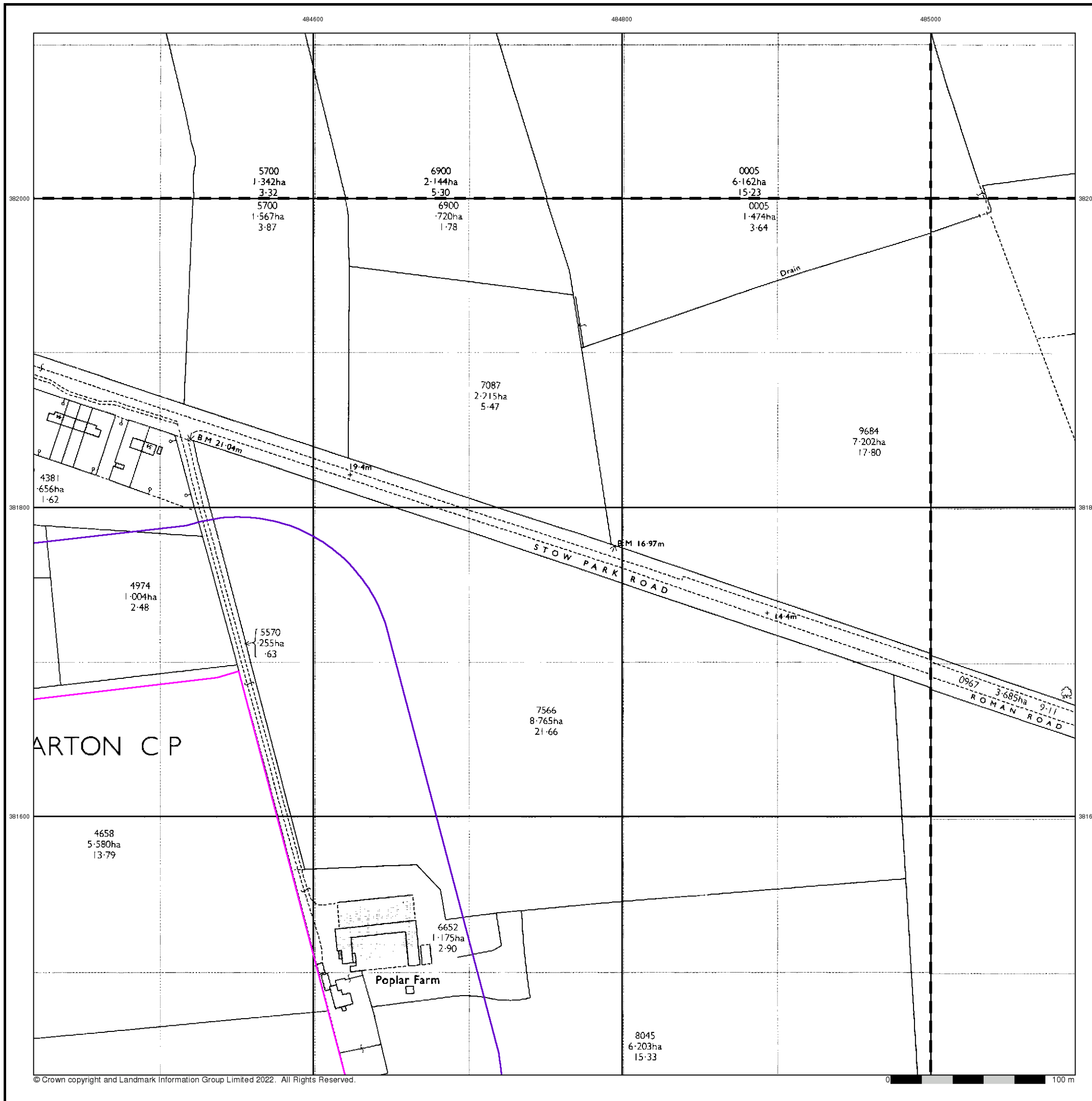

Additional SIMs

Published 1993

Source map scale - 1:2,500

The SIM cards (Ordnance Survey's 'Survey of Information on Microfilm') are further, minor editions of mapping which were produced and published in between the main editions as an area was updated. They date from 1947 to 1994, and contain detailed information on buildings, roads and land-use. These maps were produced at both 1:2,500 and 1:1,250 scales.

Map Name(s) and Date(s)

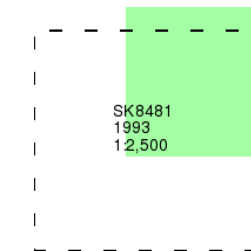

Historical Map - Segment E16

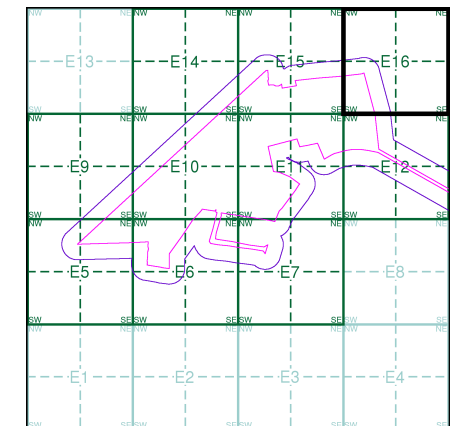

Order Details

Order Number: 298001007_1_1
 Customer Ref: 21-1098.04
 National Grid Reference: 483820, 381060
 Slice: E
 Site Area (Ha): 471.82
 Search Buffer (m): 100

Site Details

West Barton 1

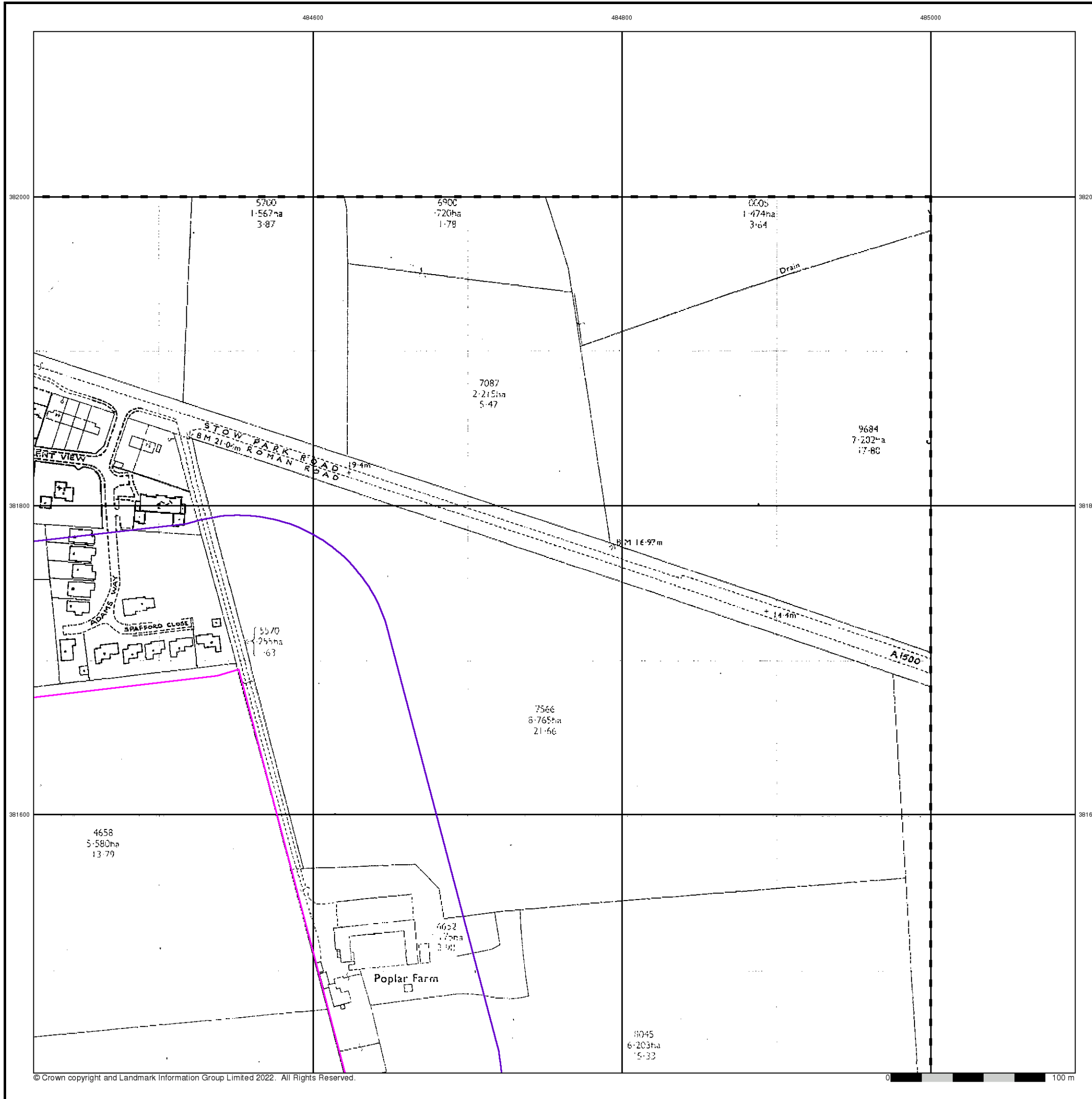

Large-Scale National Grid Data

Published 1994

Source map scale - 1:2,500

'Large Scale National Grid Data' superseded SIM cards (Ordnance Survey's 'Survey of Information on Microfilm') in 1992, and continued to be produced until 1999. These maps were the fore-runners of digital mapping and so provide detailed information on houses and roads, but tend to show less topographic features such as vegetation. These maps were produced at both 1:2,500 and 1:1,250 scales.

Map Name(s) and Date(s)

SK8482 1994 1:2,500	SK8582 1994 1:2,500
SK8481 1994 1:2,500	SK8581 1994 1:2,500

Historical Map - Segment E16

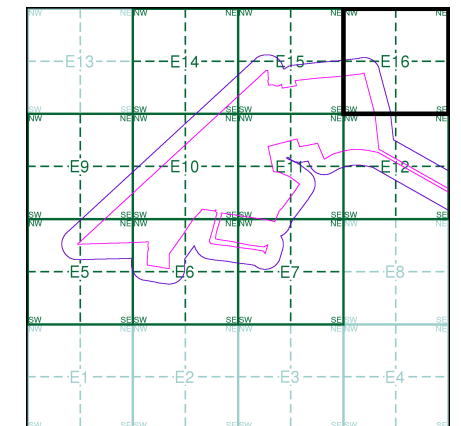

Order Details

Order Number: 298001007_1_1
 Customer Ref: 21-1098.04
 National Grid Reference: 483820, 381060
 Slice: E
 Site Area (Ha): 471.82
 Search Buffer (m): 100

Site Details

West Barton 1



Historical Mapping Legends

Ordnance Survey County Series 1:10,560

- Gravel Pit
- Sand Pit
- Other Pits
- Quarry
- Shingle
- Orchard
- Osiers
- Reeds
- Marsh
- Mixed Wood
- Deciduous
- Brushwood
- Fir
- Furze
- Rough Pasture
- Arrow denotes flow of water
- Trigonometrical Station
- Site of Antiquities
- Bench Mark
- Pump, Guide Post, Signal Post
- Well, Spring, Boundary Post
- 285** Surface Level
- Sketched Contour
- Instrumental Contour
- Main Roads (Fenced, Un-Fenced)
- Minor Roads (Fenced, Un-Fenced)
- Sunken Road
- Raised Road
- Road over Railway
- Railway over River
- Railway over Road
- Level Crossing
- Road over River or Canal
- Road over Stream
- Road over Stream
- County Boundary (Geographical)
- County & Civil Parish Boundary
- Administrative County & Civil Parish Boundary
- County Borough Boundary (England)
- County Burgh Boundary (Scotland)
- Rural District Boundary
- Civil Parish Boundary

Ordnance Survey Plan 1:10,000

- Chalk Pit, Clay Pit or Quarry
- Gravel Pit
- Sand Pit
- Disused Pit or Quarry
- Refuse or Slag Heap
- Lake, Loch or Pond
- Dunes
- Boulders
- Coniferous Trees
- Non-Coniferous Trees
- Orchard
- Scrub
- Coppice
- Bracken
- Heath
- Rough Grassland
- Marsh
- Reeds
- Saltings
- Building
- Glasshouse
- Sloping Masonry
- Pylon
- Electricity Transmission Line
- Pole
- Cutting
- Embankment
- Standard Gauge Multiple Track
- Standard Gauge Single Track
- Siding, Tramway or Mineral Line
- Narrow Gauge
- Geographical County
- Administrative County, County Borough or County of City
- Municipal Borough, Urban or Rural District, Burgh or District Council
- Borough, Burgh or County Constituency (Shown only when not coincident with other boundaries)
- Civil Parish (Shown alternately when coincidence of boundaries occurs)
- BP, BS Boundary Post or Stone
- Ch Church
- CH Club House
- F E Sta Fire Engine Station
- FB Foot Bridge
- Fn Fountain
- GP Guide Post
- MP Mile Post
- MS Mile Stone
- Pol Sta Police Station
- PO Post Office
- PC Public Convenience
- PH Public House
- SB Signal Box
- Spr Spring
- TCB Telephone Call Box
- TCP Telephone Call Post
- W Well

1:10,000 Raster Mapping

- Gravel Pit
- Refuse tip or slag heap
- Rock
- Rock (scattered)
- Boulders
- Boulders (scattered)
- Mud
- Mud
- Sand Pit
- Sand
- Sand Pit
- Slopes
- Top of cliff
- General detail
- Underground detail
- Overhead detail
- Narrow gauge railway
- Multi-track railway
- Single track railway
- County boundary (England only)
- Civil, parish or community boundary
- District, Unitary, Metropolitan, London Borough boundary
- Constituency boundary
- Area of wooded vegetation
- Non-coniferous trees
- Non-coniferous trees (scattered)
- Coniferous trees
- Coniferous trees (scattered)
- Positioned tree
- Orchard
- Coppice or Osiers
- Rough Grassland
- Heath
- Scrub
- Marsh, Salt Marsh or Reeds
- Water feature
- Flow arrows
- MHW(S) Mean high water (springs)
- MLW(S) Mean low water (springs)
- Telephone line (where shown)
- Electricity transmission line (with poles)
- Bench mark (where shown)
- Triangulation station
- Point feature (e.g. Guide Post or Mile Stone)
- Pylon, flare stack or lighting tower
- Site of (antiquity)
- Glasshouse
- General Building
- Important Building



Historical Mapping & Photography included:

Mapping Type	Scale	Date	Pg
Lincolnshire	1:10,560	1885	2
Nottinghamshire	1:10,560	1900	3
Lincolnshire	1:10,560	1906 - 1907	4
Lincolnshire	1:10,560	1907	5
Lincolnshire	1:10,560	1922	6
Lincolnshire	1:10,560	1922	7
Lincolnshire	1:10,560	1947	8
Ordnance Survey Plan	1:10,000	1956	9
Ordnance Survey Plan	1:10,000	1979	10
Ordnance Survey Plan	1:10,000	1981	11
10K Raster Mapping	1:10,000	2000	12
Street View	Variable		13

Historical Map - Slice F

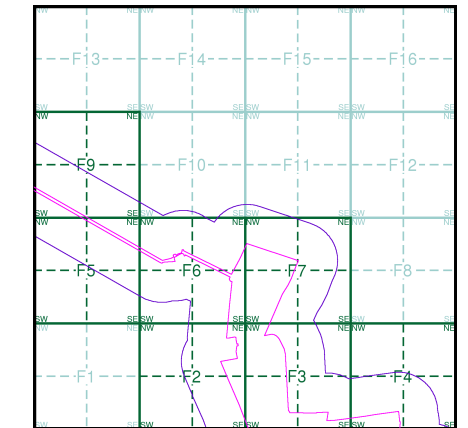

Order Details

Order Number: 298001007_1_1
 Customer Ref: 21-1098.04
 National Grid Reference: 486340, 380210
 Slice: F
 Site Area (Ha): 471.82
 Search Buffer (m): 250

Site Details

West Barton 1



Tel: 0844 844 9952
 Fax: 0844 844 9951
 Web: [REDACTED]

Lincolnshire

Published 1885

Source map scale - 1:10,560

The historical maps shown were reproduced from maps predominantly held at the scale adopted for England, Wales and Scotland in the 1840's. In 1854 the 1:2,500 scale was adopted for mapping urban areas; these maps were used to update the 1:10,560 maps. The published date given therefore is often some years later than the surveyed date. Before 1938, all OS maps were based on the Cassini Projection, with independent surveys of a single county or group of counties, giving rise to significant inaccuracies in outlying areas. In the late 1940's, a Provisional Edition was produced, which updated the 1:10,560 mapping from a number of sources. The maps appear unfinished - with all military camps and other strategic sites removed. These maps were initially overprinted with the National Grid. In 1970, the first 1:10,000 maps were produced using the Transverse Mercator Projection. The revision process continued until recently, with new editions appearing every 10 years or so for urban areas.

Map Name(s) and Date(s)

051SW 1885 1:10,560	051SE 1885 1:10,560
060NW 1885 1:10,560	060NE 1885 1:10,560

Historical Map - Slice F

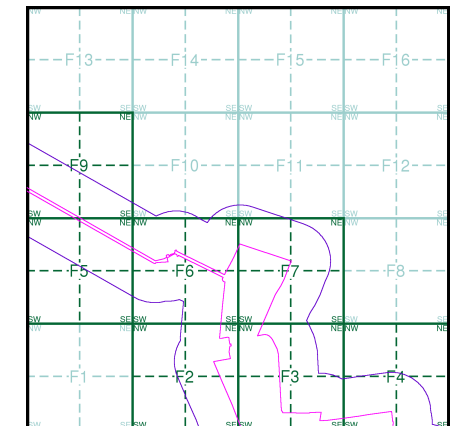

Order Details

Order Number: 298001007_1_1
 Customer Ref: 21-1098.04
 National Grid Reference: 486340, 380210
 Slice: F
 Site Area (Ha): 471.82
 Search Buffer (m): 250

Site Details

West Barton 1

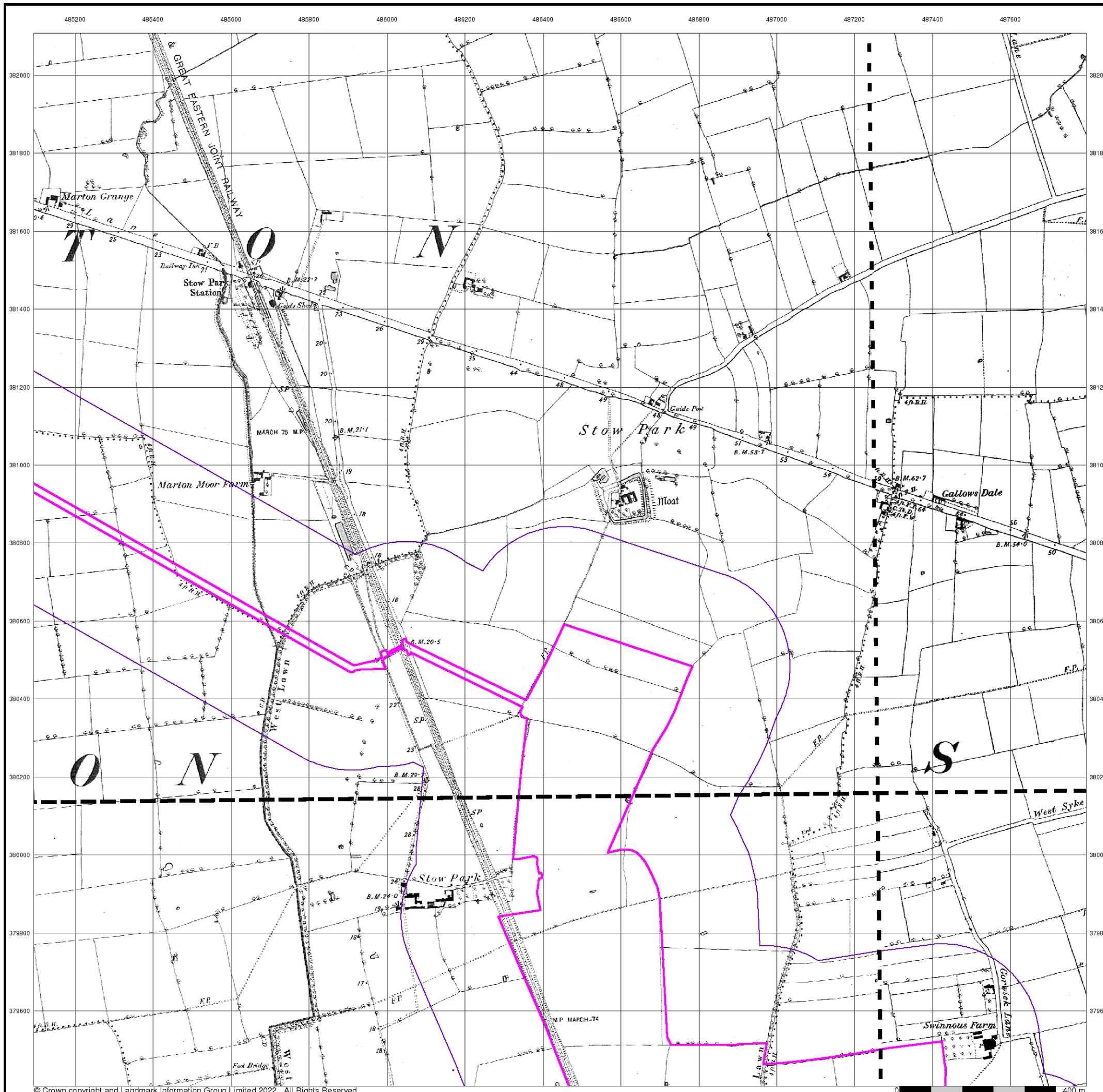

Nottinghamshire

Published 1900

Source map scale - 1:10,560

The historical maps shown were reproduced from maps predominantly held at the scale adopted for England, Wales and Scotland in the 1840's. In 1854 the 1:2,500 scale was adopted for mapping urban areas; these maps were used to update the 1:10,560 maps. The published date given therefore is often some years later than the surveyed date. Before 1938, all OS maps were based on the Cassini Projection, with independent surveys of a single county or group of counties, giving rise to significant inaccuracies in outlying areas. In the late 1940's, a Provisional Edition was produced, which updated the 1:10,560 mapping from a number of sources. The maps appear unfinished - with all military camps and other strategic sites removed. These maps were initially overprinted with the National Grid. In 1970, the first 1:10,000 maps were produced using the Transverse Mercator Projection. The revision process continued until recently, with new editions appearing every 10 years or so for urban areas.

Map Name(s) and Date(s)

011SW	1900	1:10,560
016NW	1900	1:10,560

Historical Map - Slice F

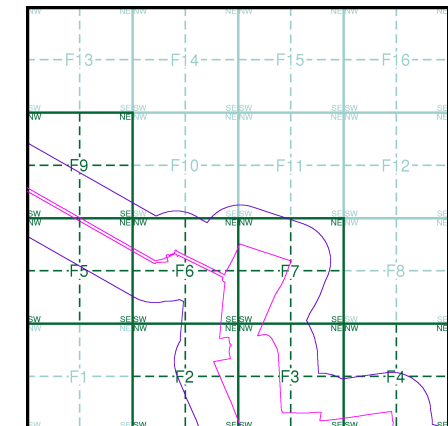

Order Details

Order Number: 298001007_1_1
 Customer Ref: 21-1098.04
 National Grid Reference: 486340, 380210
 Slice: F
 Site Area (Ha): 471.82
 Search Buffer (m): 250

Site Details

West Barton 1

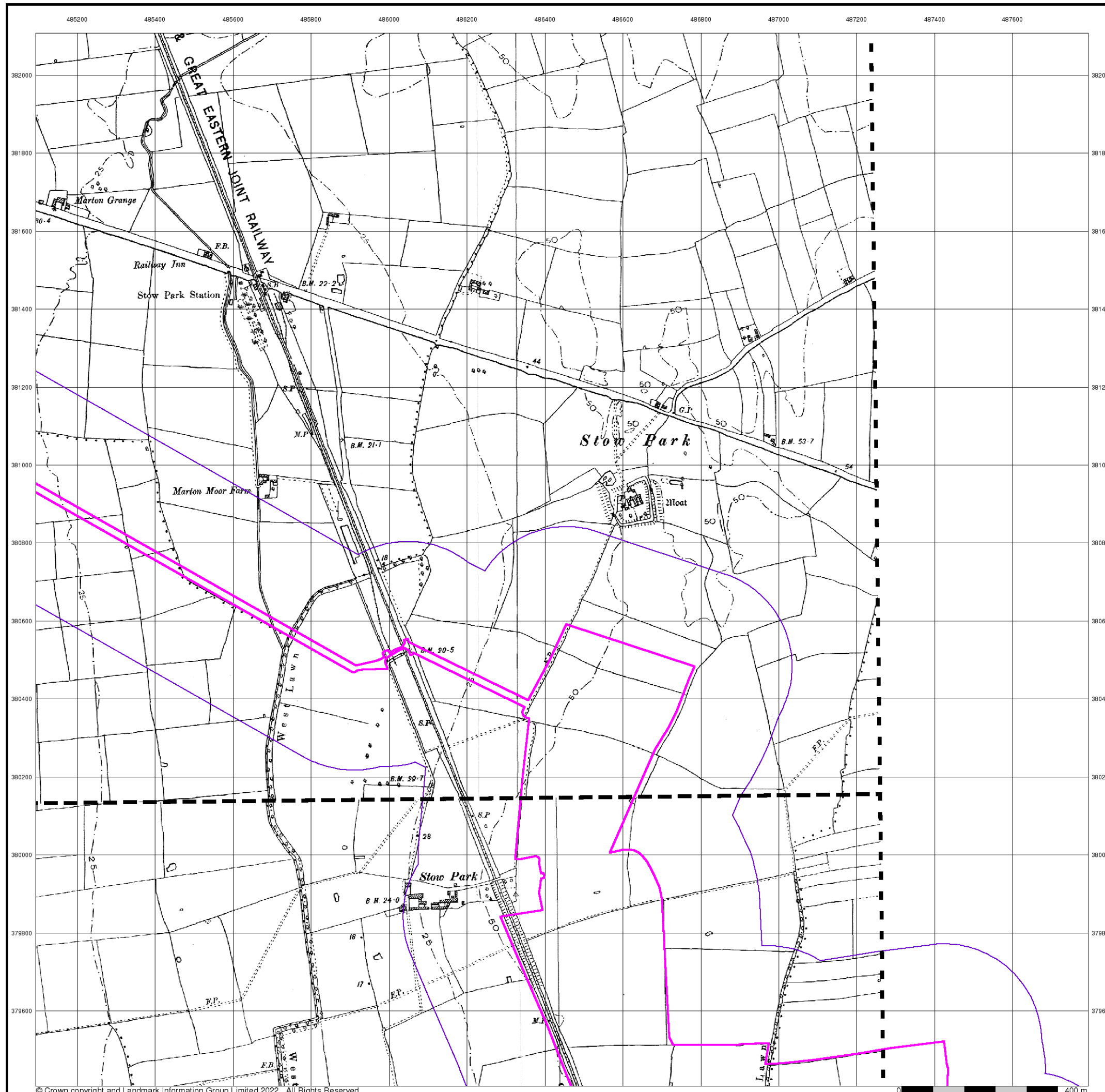

Lincolnshire

Published 1906 - 1907

Source map scale - 1:10,560

The historical maps shown were reproduced from maps predominantly held at the scale adopted for England, Wales and Scotland in the 1840's. In 1854 the 1:2,500 scale was adopted for mapping urban areas; these maps were used to update the 1:10,560 maps. The published date given therefore is often some years later than the surveyed date. Before 1938, all OS maps were based on the Cassini Projection, with independent surveys of a single county or group of counties, giving rise to significant inaccuracies in outlying areas. In the late 1940's, a Provisional Edition was produced, which updated the 1:10,560 mapping from a number of sources. The maps appear unfinished - with all military camps and other strategic sites removed. These maps were initially overprinted with the National Grid. In 1970, the first 1:10,000 maps were produced using the Transverse Mercator Projection. The revision process continued until recently, with new editions appearing every 10 years or so for urban areas.

Map Name(s) and Date(s)

051SW 1906 1:10,560	051SE 1907 1:10,560
060NW 1906 1:10,560	060NE 1907 1:10,560

Historical Map - Slice F

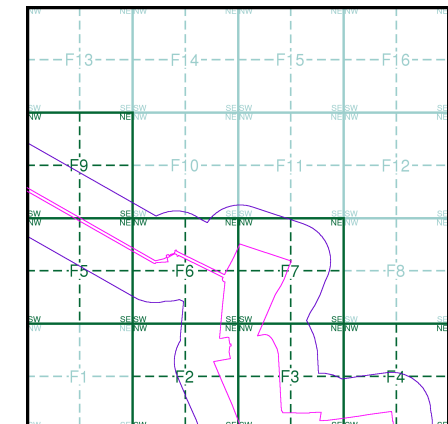

Order Details

Order Number: 298001007_1_1
 Customer Ref: 21-1098.04
 National Grid Reference: 486340, 380210
 Slice: F
 Site Area (Ha): 471.82
 Search Buffer (m): 250

Site Details

West Barton 1

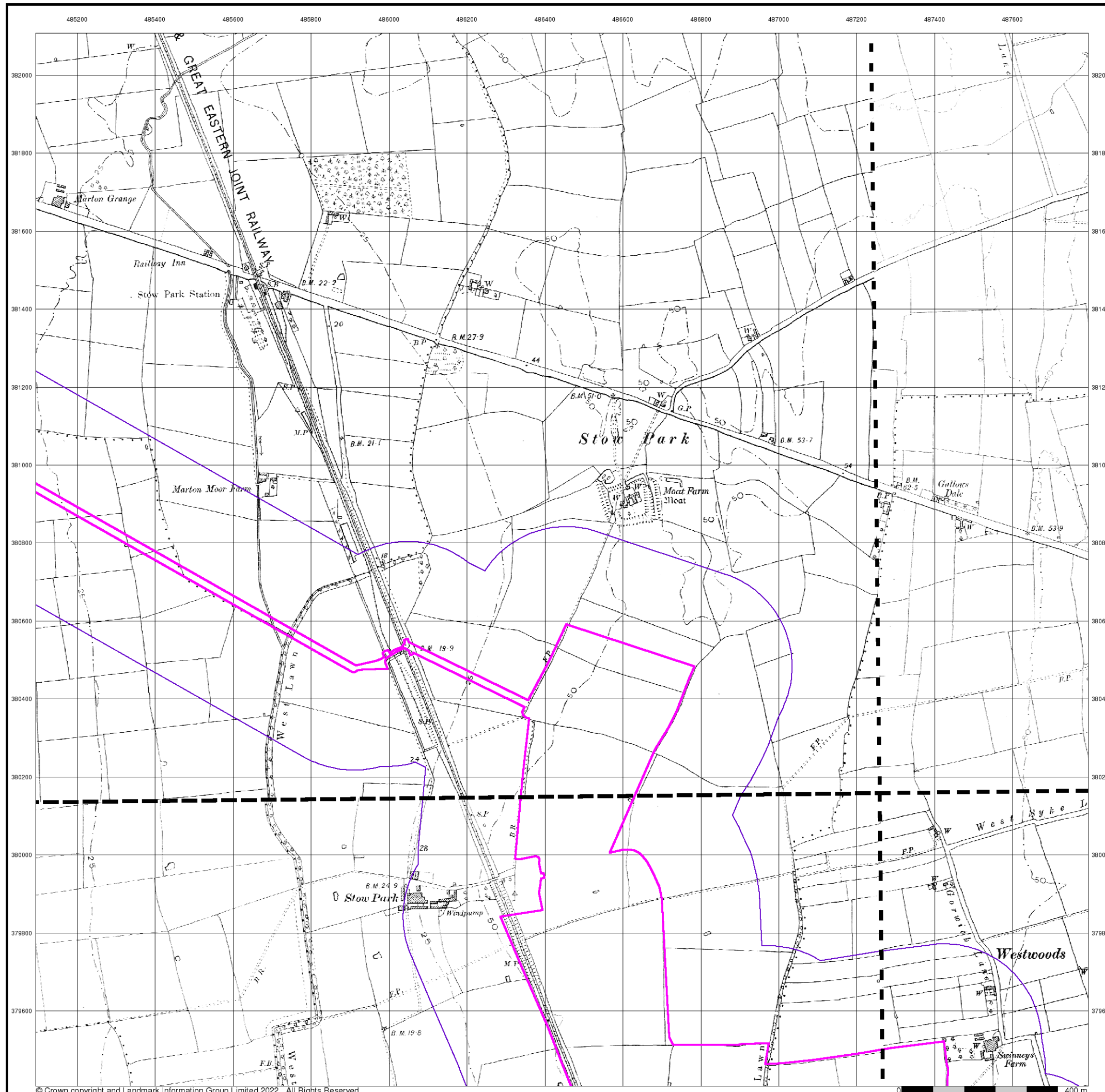

Lincolnshire

Published 1907

Source map scale - 1:10,560

The historical maps shown were reproduced from maps predominantly held at the scale adopted for England, Wales and Scotland in the 1840's. In 1854 the 1:2,500 scale was adopted for mapping urban areas; these maps were used to update the 1:10,560 maps. The published date given therefore is often some years later than the surveyed date. Before 1938, all OS maps were based on the Cassini Projection, with independent surveys of a single county or group of counties, giving rise to significant inaccuracies in outlying areas. In the late 1940's, a Provisional Edition was produced, which updated the 1:10,560 mapping from a number of sources. The maps appear unfinished - with all military camps and other strategic sites removed. These maps were initially overprinted with the National Grid. In 1970, the first 1:10,000 maps were produced using the Transverse Mercator Projection. The revision process continued until recently, with new editions appearing every 10 years or so for urban areas.

Map Name(s) and Date(s)

051SE	1907	1:10,560
060NE	1907	1:10,560

Historical Map - Slice F

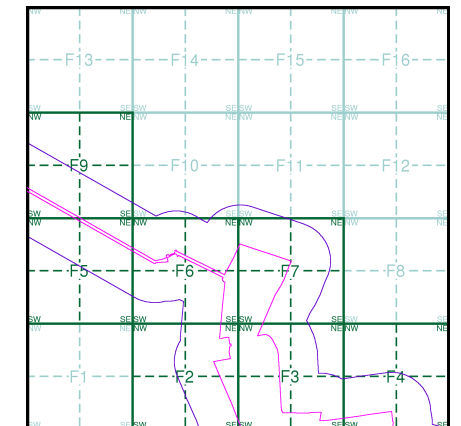

Order Details

Order Number: 298001007_1_1
 Customer Ref: 21-1098.04
 National Grid Reference: 486340, 380210
 Slice: F
 Site Area (Ha): 471.82
 Search Buffer (m): 250

Site Details

West Barton 1

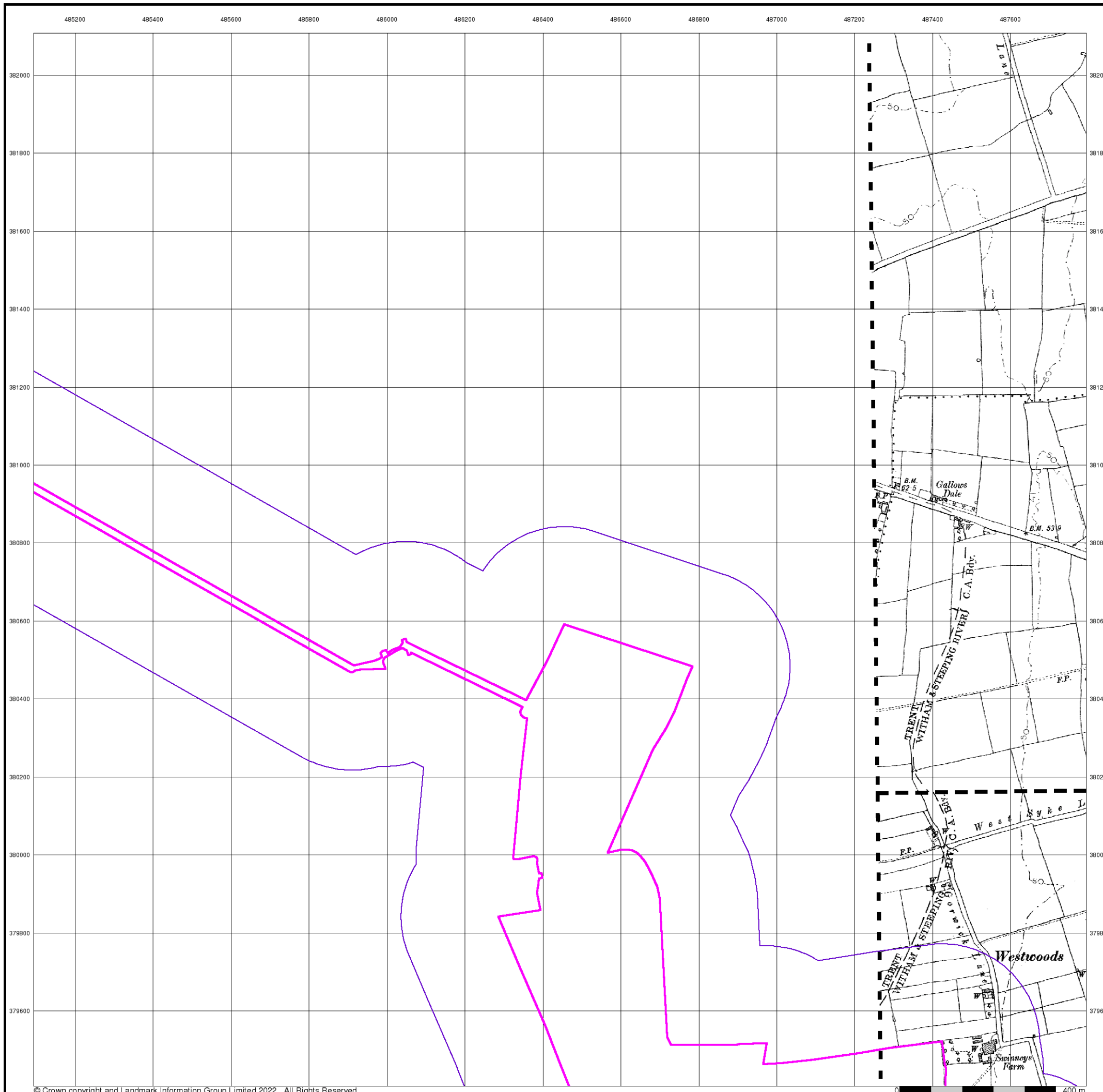

Lincolnshire

Published 1922

Source map scale - 1:10,560

The historical maps shown were reproduced from maps predominantly held at the scale adopted for England, Wales and Scotland in the 1840's. In 1854 the 1:2,500 scale was adopted for mapping urban areas; these maps were used to update the 1:10,560 maps. The published date given therefore is often some years later than the surveyed date. Before 1938, all OS maps were based on the Cassini Projection, with independent surveys of a single county or group of counties, giving rise to significant inaccuracies in outlying areas. In the late 1940's, a Provisional Edition was produced, which updated the 1:10,560 mapping from a number of sources. The maps appear unfinished - with all military camps and other strategic sites removed. These maps were initially overprinted with the National Grid. In 1970, the first 1:10,000 maps were produced using the Transverse Mercator Projection. The revision process continued until recently, with new editions appearing every 10 years or so for urban areas.

Map Name(s) and Date(s)

051SW	1922	1:10,560
060NW	1922	1:10,560

Historical Map - Slice F

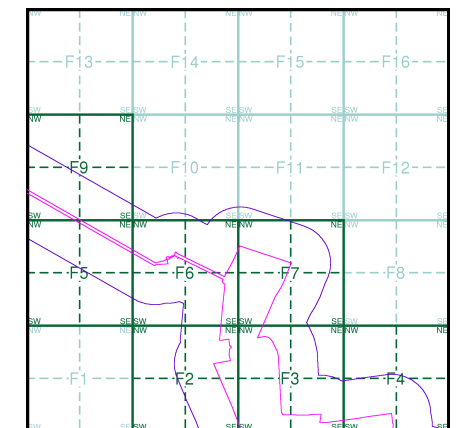

Order Details

Order Number: 298001007_1_1
 Customer Ref: 21-1098.04
 National Grid Reference: 486340, 380210
 Slice: F
 Site Area (Ha): 471.82
 Search Buffer (m): 250

Site Details

West Barton 1

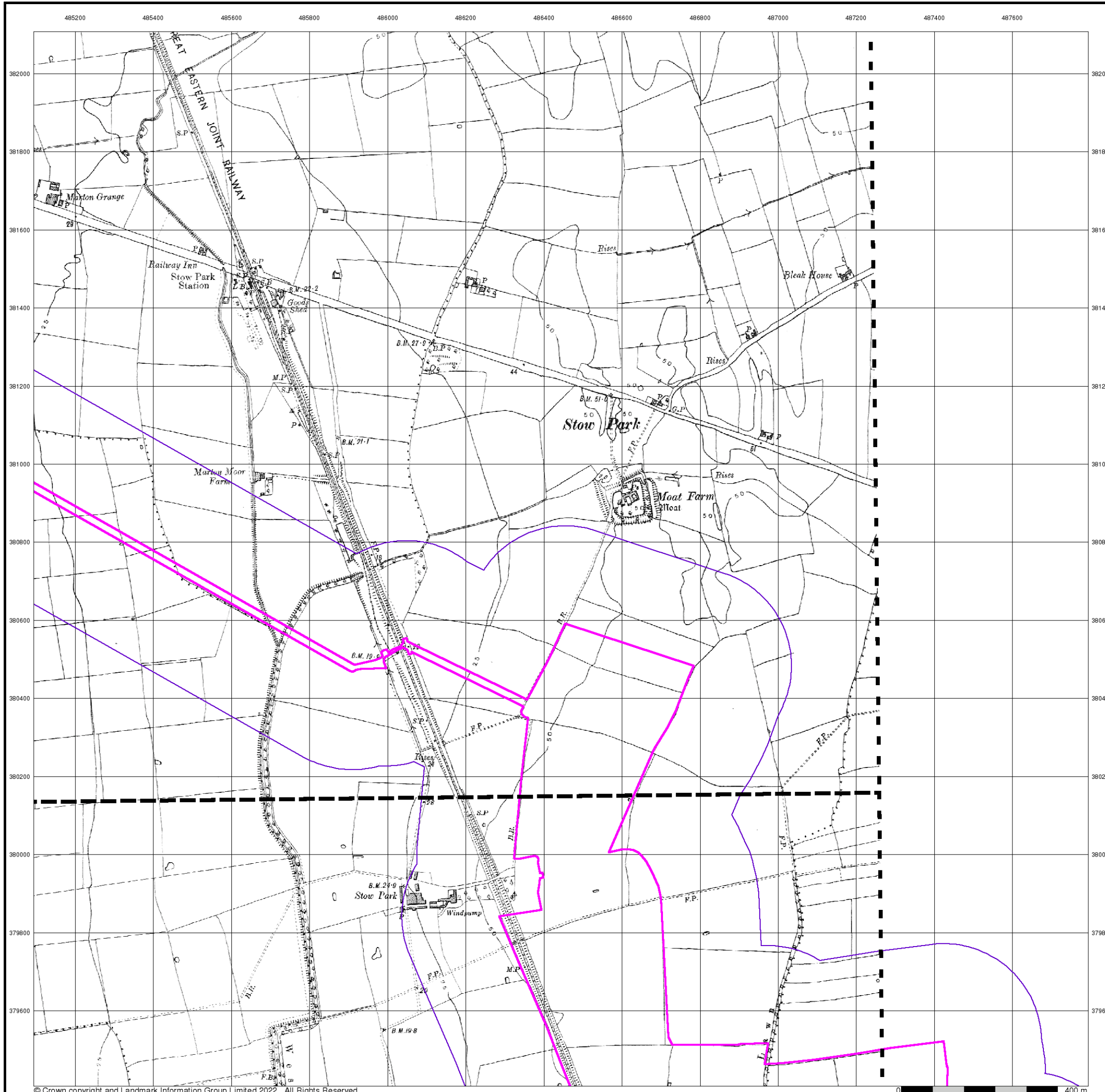

Lincolnshire

Published 1922

Source map scale - 1:10,560

The historical maps shown were reproduced from maps predominantly held at the scale adopted for England, Wales and Scotland in the 1840's. In 1854 the 1:2,500 scale was adopted for mapping urban areas; these maps were used to update the 1:10,560 maps. The published date given therefore is often some years later than the surveyed date. Before 1938, all OS maps were based on the Cassini Projection, with independent surveys of a single county or group of counties, giving rise to significant inaccuracies in outlying areas. In the late 1940's, a Provisional Edition was produced, which updated the 1:10,560 mapping from a number of sources. The maps appear unfinished - with all military camps and other strategic sites removed. These maps were initially overprinted with the National Grid. In 1970, the first 1:10,000 maps were produced using the Transverse Mercator Projection. The revision process continued until recently, with new editions appearing every 10 years or so for urban areas.

Map Name(s) and Date(s)

051SW	1922	1:10,560
060NW	1922	1:10,560

Historical Map - Slice F

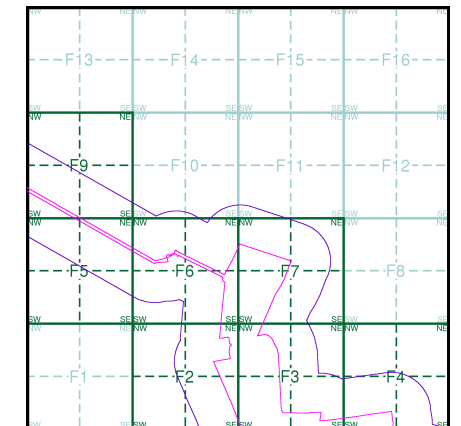

Order Details

Order Number: 298001007_1_1
 Customer Ref: 21-1098.04
 National Grid Reference: 486340, 380210
 Slice: F
 Site Area (Ha): 471.82
 Search Buffer (m): 250

Site Details

West Barton 1

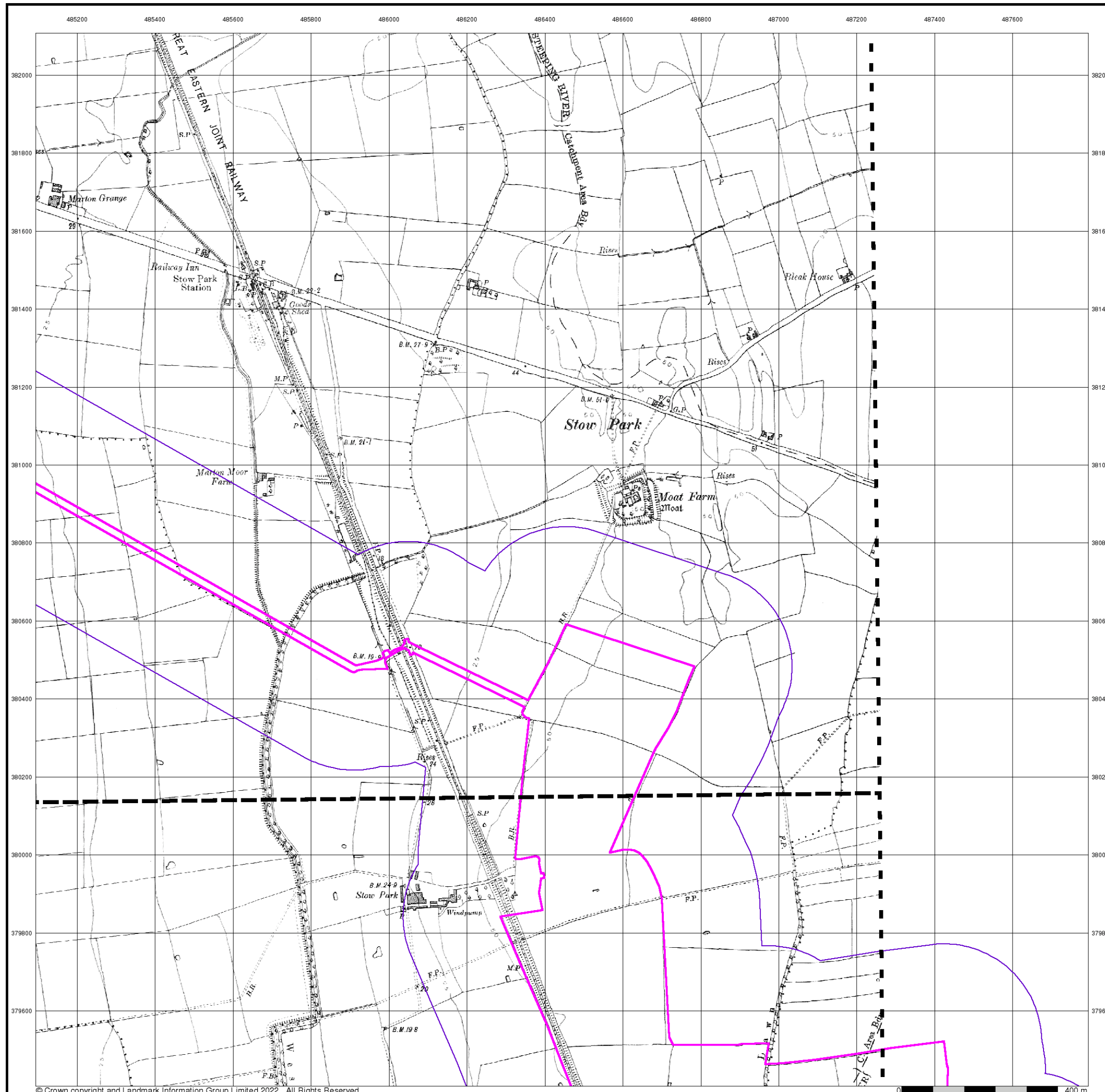

Lincolnshire

Published 1947

Source map scale - 1:10,560

The historical maps shown were reproduced from maps predominantly held at the scale adopted for England, Wales and Scotland in the 1840's. In 1854 the 1:2,500 scale was adopted for mapping urban areas; these maps were used to update the 1:10,560 maps. The published date given therefore is often some years later than the surveyed date. Before 1938, all OS maps were based on the Cassini Projection, with independent surveys of a single county or group of counties, giving rise to significant inaccuracies in outlying areas. In the late 1940's, a Provisional Edition was produced, which updated the 1:10,560 mapping from a number of sources. The maps appear unfinished - with all military camps and other strategic sites removed. These maps were initially overprinted with the National Grid. In 1970, the first 1:10,000 maps were produced using the Transverse Mercator Projection. The revision process continued until recently, with new editions appearing every 10 years or so for urban areas.

Map Name(s) and Date(s)

051SW 1947 1:10,560	051SE 1947 1:10,560
060NW 1947 1:10,560	060NE 1947 1:10,560

Historical Map - Slice F

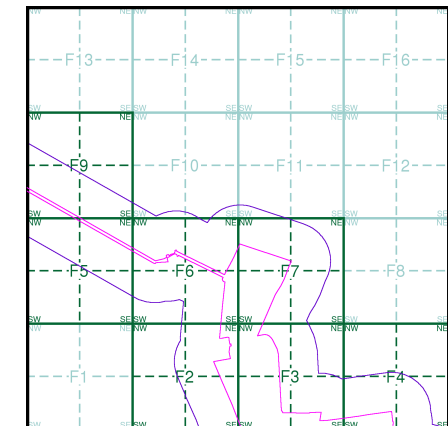

Order Details

Order Number: 298001007_1_1
 Customer Ref: 21-1098.04
 National Grid Reference: 486340, 380210
 Slice: F
 Site Area (Ha): 471.82
 Search Buffer (m): 250

Site Details

West Barton 1

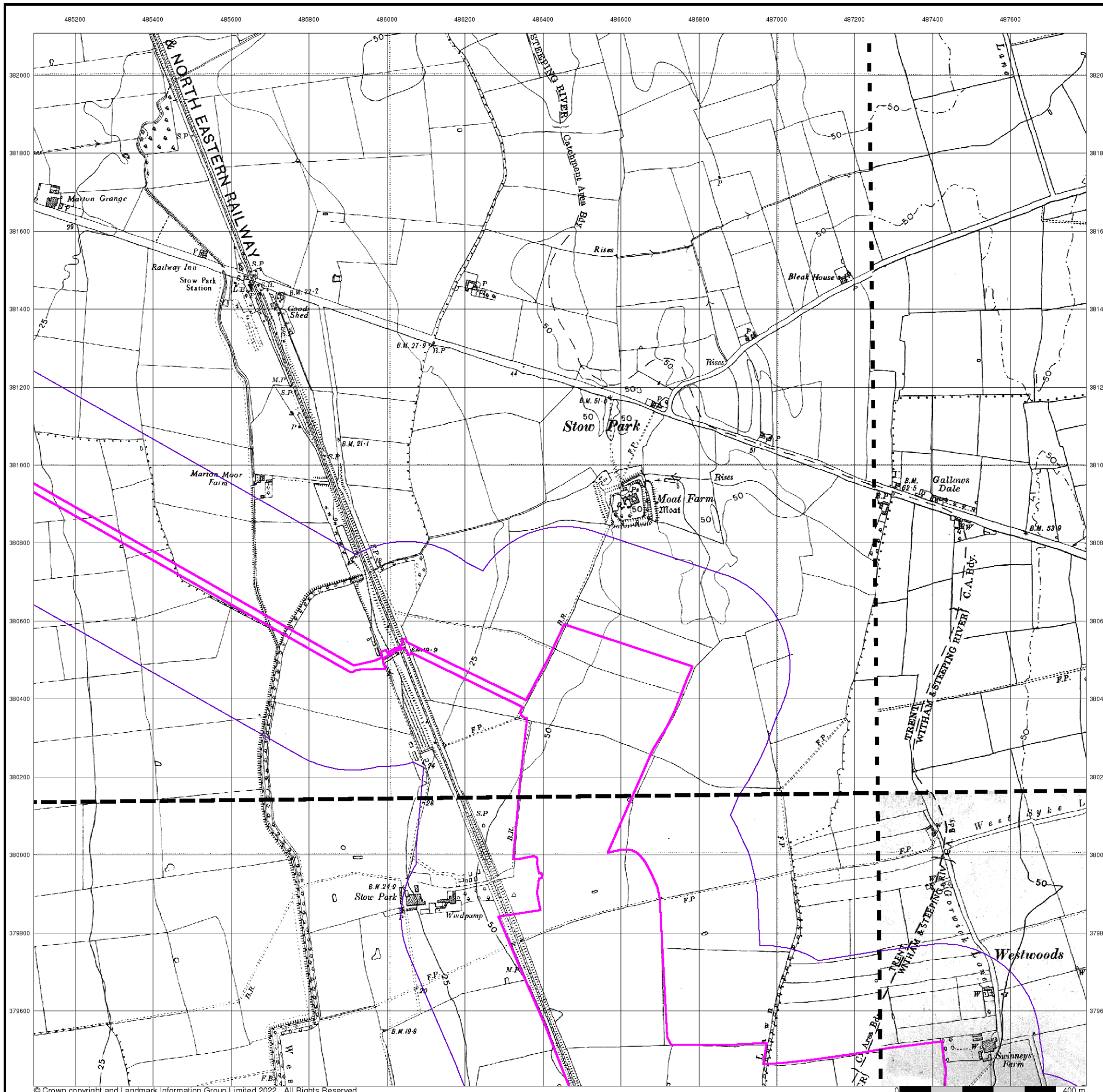

Ordnance Survey Plan

Published 1956

Source map scale - 1:10,000

The historical maps shown were reproduced from maps predominantly held at the scale adopted for England, Wales and Scotland in the 1840's. In 1854 the 1:2,500 scale was adopted for mapping urban areas; these maps were used to update the 1:10,560 maps. The published date given therefore is often some years later than the surveyed date. Before 1938, all OS maps were based on the Cassini Projection, with independent surveys of a single county or group of counties, giving rise to significant inaccuracies in outlying areas. In the late 1940's, a Provisional Edition was produced, which updated the 1:10,560 mapping from a number of sources. The maps appear unfinished - with all military camps and other strategic sites removed. These maps were initially overprinted with the National Grid. In 1970, the first 1:10,000 maps were produced using the Transverse Mercator Projection. The revision process continued until recently, with new editions appearing every 10 years or so for urban areas.

Map Name(s) and Date(s)

SK88SE	1956
1:10,560	
SK87NE	1956
1:10,560	

Historical Map - Slice F

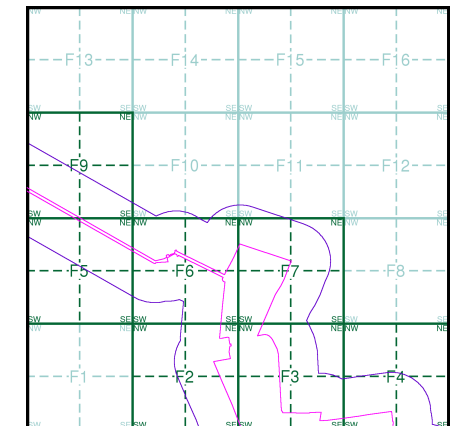

Order Details

Order Number: 298001007_1_1
 Customer Ref: 21-1098.04
 National Grid Reference: 486340, 380210
 Slice: F
 Site Area (Ha): 471.82
 Search Buffer (m): 250

Site Details

West Barton 1

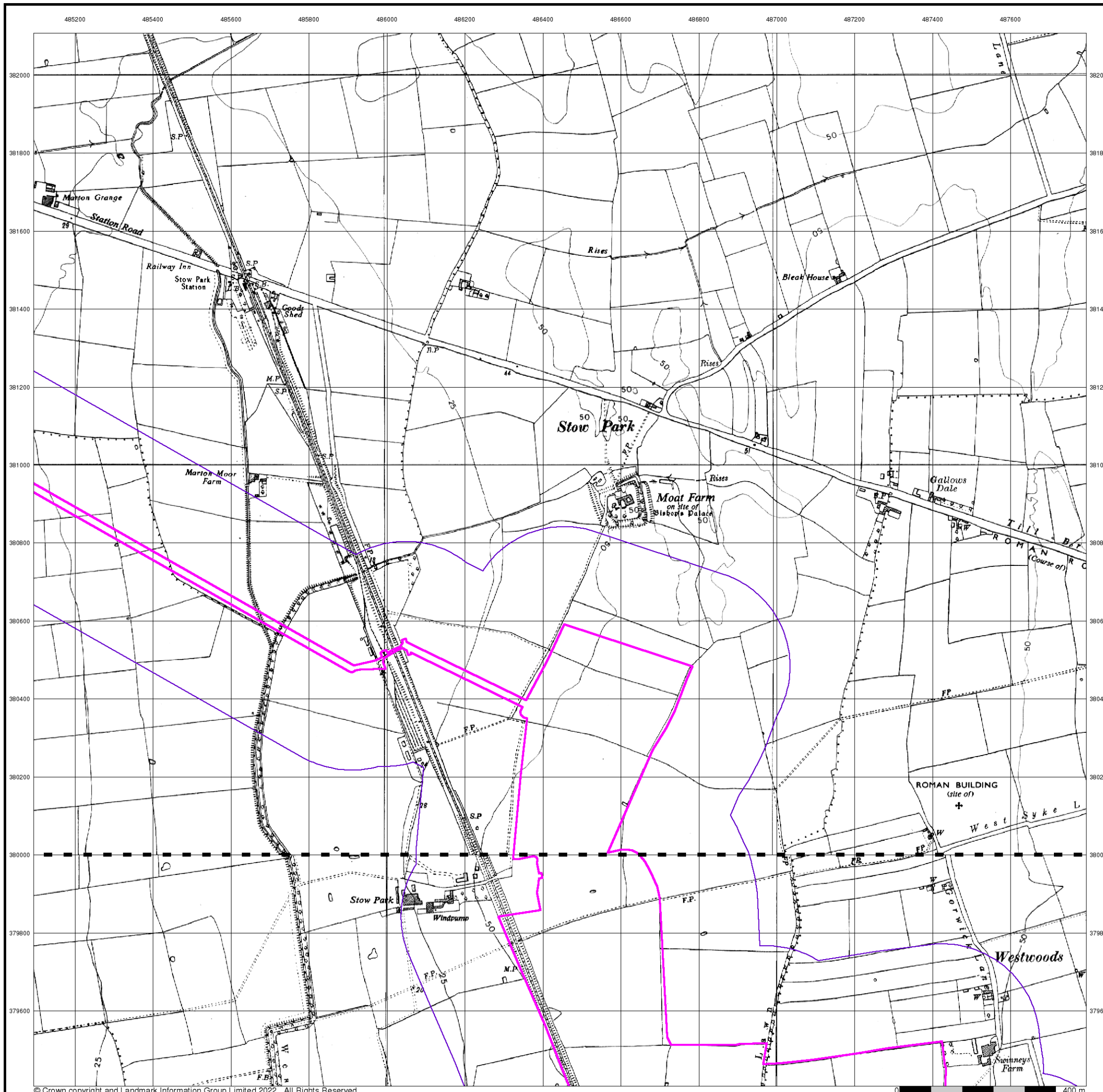

Ordnance Survey Plan

Published 1979

Source map scale - 1:10,000

The historical maps shown were reproduced from maps predominantly held at the scale adopted for England, Wales and Scotland in the 1840's. In 1854 the 1:2,500 scale was adopted for mapping urban areas; these maps were used to update the 1:10,560 maps. The published date given therefore is often some years later than the surveyed date. Before 1938, all OS maps were based on the Cassini Projection, with independent surveys of a single county or group of counties, giving rise to significant inaccuracies in outlying areas. In the late 1940's, a Provisional Edition was produced, which updated the 1:10,560 mapping from a number of sources. The maps appear unfinished - with all military camps and other strategic sites removed. These maps were initially overprinted with the National Grid. In 1970, the first 1:10,000 maps were produced using the Transverse Mercator Projection. The revision process continued until recently, with new editions appearing every 10 years or so for urban areas.

Map Name(s) and Date(s)

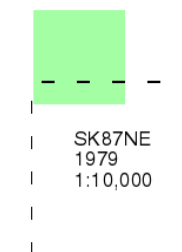

Historical Map - Slice F

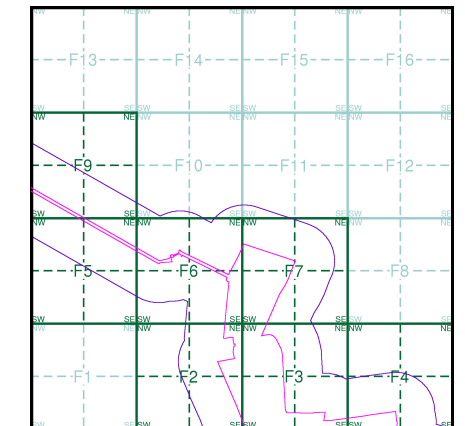

Order Details

Order Number: 298001007_1_1
 Customer Ref: 21-1098.04
 National Grid Reference: 486340, 380210
 Slice: F
 Site Area (Ha): 471.82
 Search Buffer (m): 250

Site Details

West Barton 1

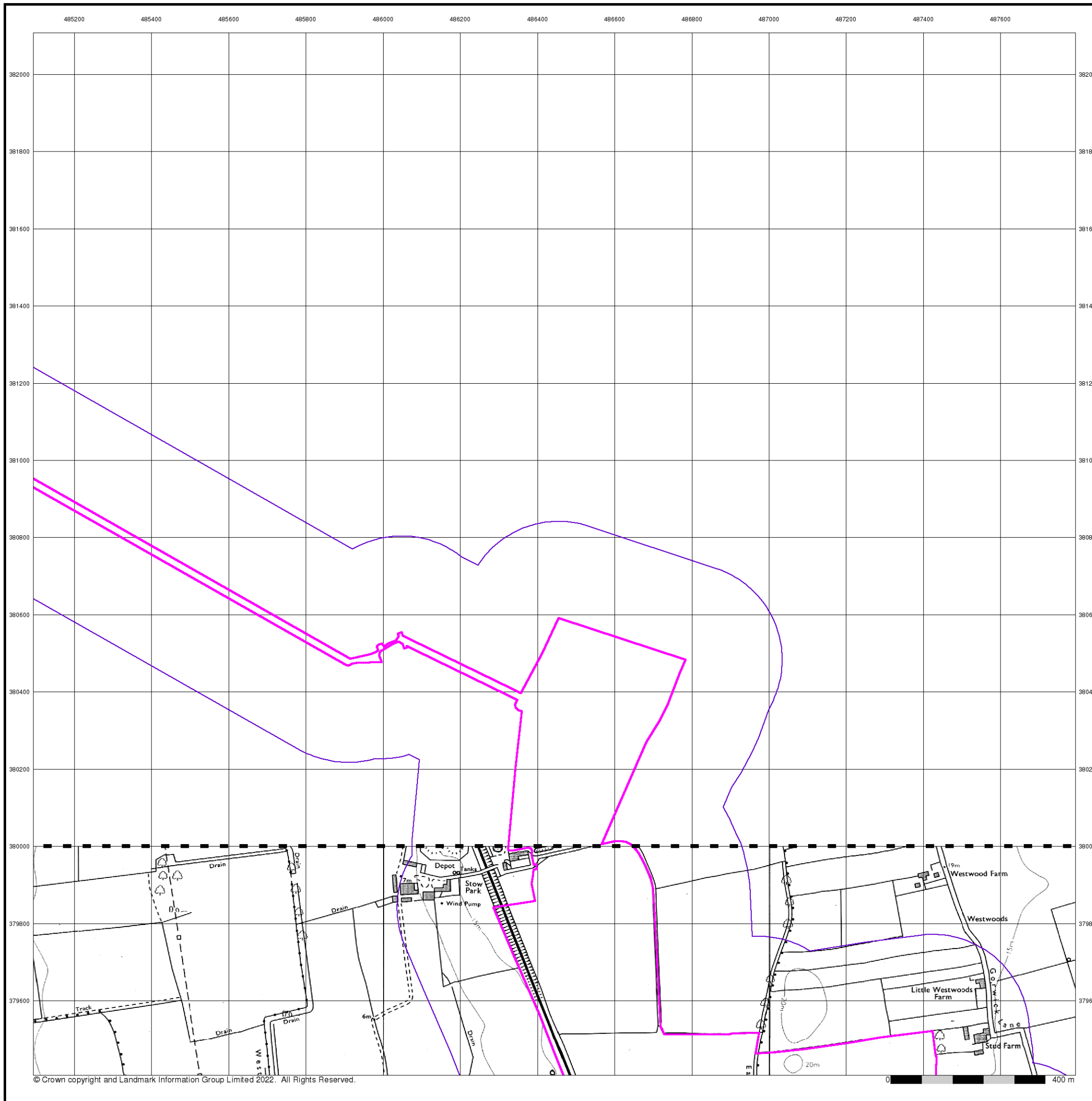

Ordnance Survey Plan

Published 1981

Source map scale - 1:10,000

The historical maps shown were reproduced from maps predominantly held at the scale adopted for England, Wales and Scotland in the 1840's. In 1854 the 1:2,500 scale was adopted for mapping urban areas; these maps were used to update the 1:10,560 maps. The published date given therefore is often some years later than the surveyed date. Before 1938, all OS maps were based on the Cassini Projection, with independent surveys of a single county or group of counties, giving rise to significant inaccuracies in outlying areas. In the late 1940's, a Provisional Edition was produced, which updated the 1:10,560 mapping from a number of sources. The maps appear unfinished - with all military camps and other strategic sites removed. These maps were initially overprinted with the National Grid. In 1970, the first 1:10,000 maps were produced using the Transverse Mercator Projection. The revision process continued until recently, with new editions appearing every 10 years or so for urban areas.

Map Name(s) and Date(s)

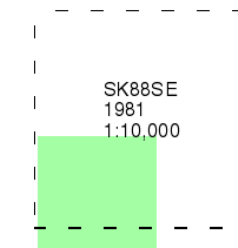

Historical Map - Slice F

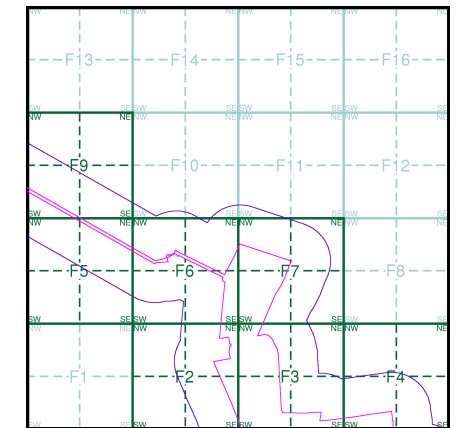

Order Details

Order Number: 298001007_1_1
 Customer Ref: 21-1098.04
 National Grid Reference: 486340, 380210
 Slice: F
 Site Area (Ha): 471.82
 Search Buffer (m): 250

Site Details

West Barton 1



10k Raster Mapping

Published 2000

Source map scale - 1:10,000

The historical maps shown were produced from the Ordnance Survey's 1:10,000 colour raster mapping. These maps are derived from Landplan which replaced the old 1:10,000 maps originally published in 1970. The data is highly detailed showing buildings, fences and field boundaries as well as all roads, tracks and paths. Road names are also included together with the relevant road number and classification. Boundary information depiction includes county, unitary authority, district, civil parish and constituency.

Map Name(s) and Date(s)

SK88SE	2000
1:10,000	
SK87NE	2000
1:10,000	

Historical Map - Slice F

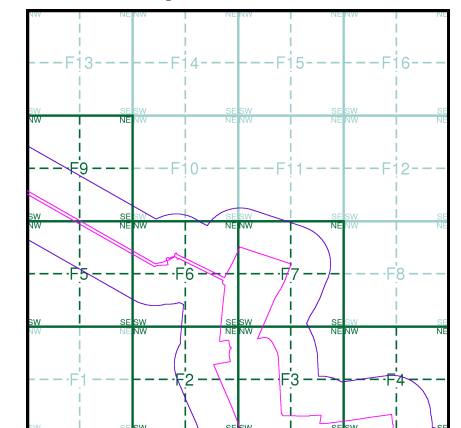

Order Details

Order Number: 298001007_1_1
 Customer Ref: 21-1098.04
 National Grid Reference: 486340, 380210
 Slice: F
 Site Area (Ha): 471.82
 Search Buffer (m): 250

Site Details

West Barton 1

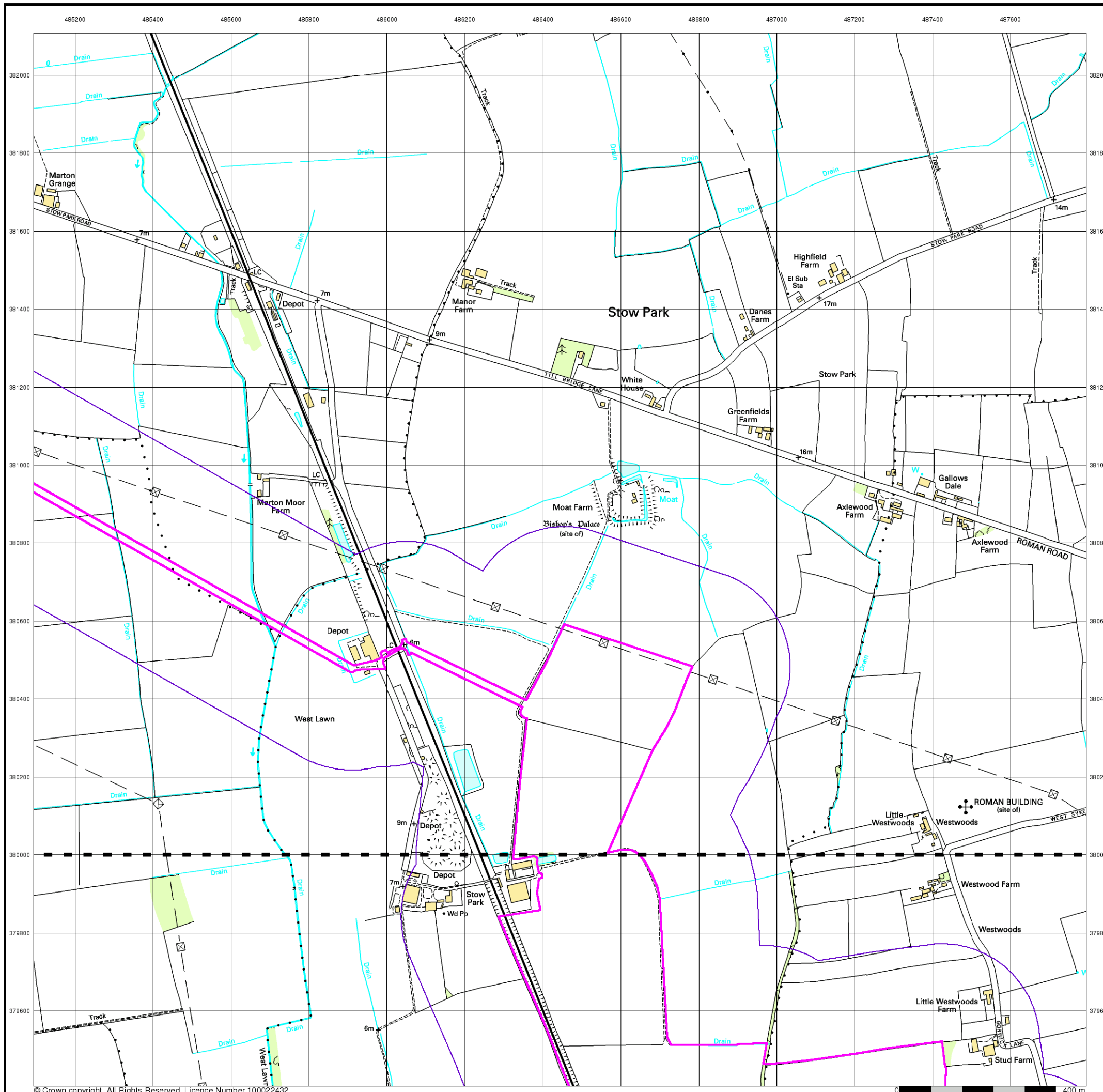

Street View

Published 2022

Source map scale - 1:10,000

Street View is a street-level map for the whole of Great Britain produced by the Ordnance Survey. These maps are provided at a nominal scale of 1:10,000

Map Name(s) and Date(s)



Street View Map - Slice F

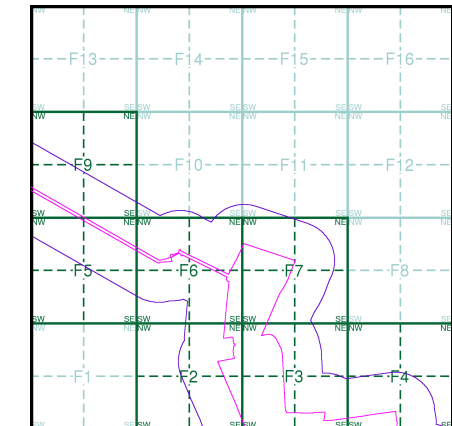

Order Details

Order Number: 298001007_1_1
 Customer Ref: 21-1098.04
 National Grid Reference: 486340, 380210
 Slice: F
 Site Area (Ha): 471.82
 Search Buffer (m): 250

Site Details

West Barton 1

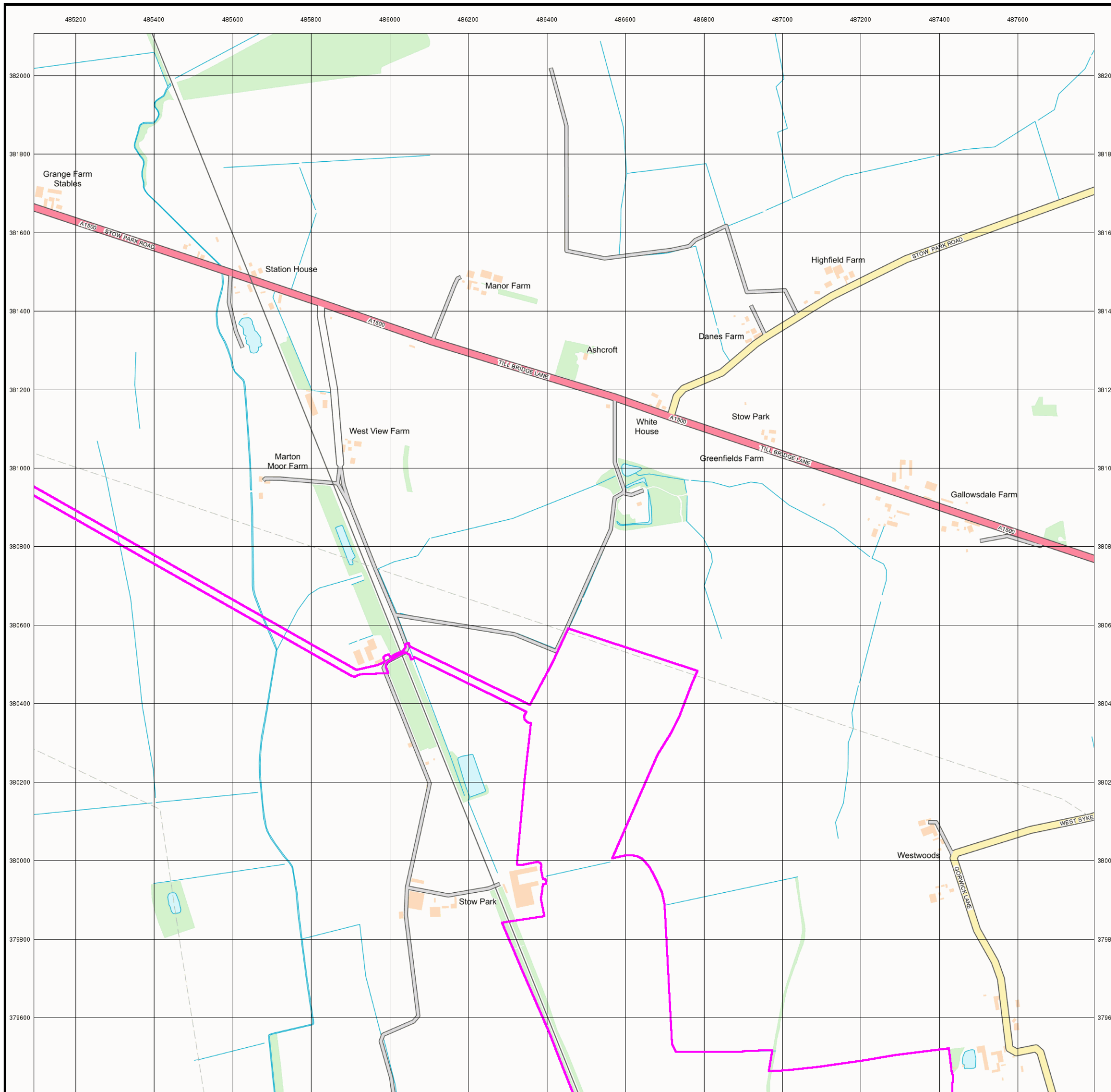

Historical Mapping Legends

Ordnance Survey County Series and Ordnance Survey Plan 1:2,500

Quarry **Gravel Pit** **Sand Pit**
Clay Pit **Shingle** **Refuse Heap**
Sloping Masonry **Flat Rock**
Marsh **Reeds** **Osiers**
Rough Pasture **Furze** **Wood**
Mixed Wood **Brushwood** **Orchard**
Fir **Ford** **Stepping Stones**
Ferry **Waterfall** **Lock**
Trig. Station **Altitude at Trig. Station**
B.M. 325.9 **Bench Mark** **Surface Level**
Arrow denotes flow of water **Antiquities (site of)**
Cutting **Embankment**
Railway crossing Road **Level Crossing** **Road crossing Railway**
Railway crossing River or Canal **Road over single stream** **Road over River or Canal**
County Boundary (Geographical)
County & Civil Parish Boundary
Administrative County & Civil Parish Boundary
County Borough Boundary (England)
County Burgh Boundary (Scotland)
Boundary Post or Stone **Police Call Box**
B.R. Bridle Road **P Pump**
E.P. Electricity Pylon **S.P. Signal Post**
F.B. Foot Bridge **Sl. Sluice**
F.P. Foot Path **Sp. Spring**
G.P. Guide Post or Board **T.C.B. Telephone Call Box**
M.S. Mile Stone **Tr. Trough**
M.P. M.R. Mooring Post or Ring **W Well**

Ordnance Survey Plan, Additional SIMs and Supply of Unpublished Survey Information 1:2,500 and 1:1,250

Inactive Quarry, Chalk Pit or Clay Pit **Active Quarry, Chalk Pit or Clay Pit**
Rock **Boulders**
Cliff **Slopes** **Top**
Roofed Building **Glazed Roof Building**
Sloping Masonry **Archway**
Non-Coniferous Tree (surveyed) **Coniferous Tree (surveyed)**
Non-Coniferous Trees (not surveyed) **Coniferous Trees (not surveyed)**
Orchard Tree **Scrub** **Bracken**
Coppice, Osier **Reeds** **Marsh, Saltings**
Rough Grassland **Heath** **Culvert**
Direction of water flow **Bench Mark** **Antiquity (site of)**
Cave Entrance **Triangulation Station** **Electricity Pylon**
Electricity Transmission Line
County Boundary (Geographical)
County & Civil Parish Boundary
Civil Parish Boundary
Admin. County or County Bor. Boundary
London Borough Boundary
Symbol marking point where boundary mereing changes
BH Beer House **P Pillar, Pole or Post**
BP, BS Boundary Post or Stone **PO Post Office**
Cn, C Capstan, Crane **PC Public Convenience**
Chy Chimney **PH Public House**
D Fn Drinking Fountain **Pp Pump**
EI P Electricity Pillar or Post **SB, S Br Signal Box or Bridge**
FAP Fire Alarm Pillar **SP, SL Signal Post or Light**
FB Foot Bridge **Spr Spring**
GP Guide Post **Tk Tank or Track**
H Hydrant or Hydraulic **TCB Telephone Call Box**
LC Level Crossing **TCP Telephone Call Post**
MH Manhole **Tr Trough**
MP Mile Post or Mooring Post **Wr Pt, Wr T Water Point, Water Tap**
MS Mile Stone **W Well**
NTL Normal Tidal Limit **Wd Pp Wind Pump**

Large-Scale National Grid Data 1:2,500 and 1:1,250

Cliff **Slopes** **Top**
Rock **Rock (scattered)**
Boulders **Boulders (scattered)**
Positioned Boulder **Scree**
Non-Coniferous Tree (surveyed) **Coniferous Tree (surveyed)**
Non-Coniferous Trees (not surveyed) **Coniferous Trees (not surveyed)**
Orchard Tree **Scrub** **Bracken**
Coppice, Osier **Reeds** **Marsh, Saltings**
Rough Grassland **Heath** **Culvert**
Direction of water flow **Triangulation Station** **Antiquity (site of)**
Electricity Transmission Line **Electricity Pylon**
Bench Mark **Buildings with Building Seed**
Roofed Building **Glazed Roof Building**
Civil parish/community boundary
District boundary
County boundary
Boundary post/stone
Boundary mereing symbol (note: these always appear in opposed pairs or groups of three)
Bks Barracks **P Pillar, Pole or Post**
Bty Battery **PO Post Office**
Cemy Cemetery **PC Public Convenience**
Chy Chimney **Pp Pump**
Cis Cistern **Ppg Sta Pumping Station**
Dismtd Rly Dismantled Railway **PW Place of Worship**
EI Gen Sta Electricity Generating Station **Sewage Ppg Sta Sewage Pumping Station**
EI P Electricity Pole, Pillar **SB, S Br Signal Box or Bridge**
EI Sub Sta Electricity Sub Station **SP, SL Signal Post or Light**
FB Filter Bed **Spr Spring**
Fn / D Fn Fountain / Drinking Ftn. **Tk Tank or Track**
Gas Gov Gas Valve Compound **Tr Trough**
GVC Gas Governor **Wd Pp Wind Pump**
GP Guide Post **Wr Pt, Wr T Water Point, Water Tap**
MH Manhole **Wks Works (building or area)**
MP, MS Mile Post or Mile Stone **W Well**

Historical Mapping & Photography included:

Mapping Type	Scale	Date	Pg
Lincolnshire	1:2,500	1886	2
Lincolnshire	1:2,500	1906	3
Lincolnshire	1:2,500	1920	4
Ordnance Survey Plan	1:2,500	1974 - 1975	5
Large-Scale National Grid Data	1:2,500	1994	6

Historical Map - Segment F2

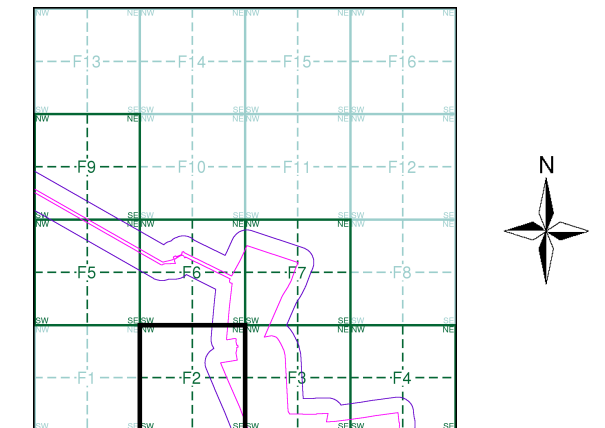

Order Details

Order Number: 298001007_1_1
 Customer Ref: 21-1098.04
 National Grid Reference: 486340, 380210
 Slice: F
 Site Area (Ha): 471.82
 Search Buffer (m): 100

Site Details

West Barton 1

Lincolnshire

Published 1886

Source map scale - 1:2,500

The historical maps shown were reproduced from maps predominantly held at the scale adopted for England, Wales and Scotland in the 1840's. In 1854 the 1:2,500 scale was adopted for mapping urban areas and by 1896 it covered the whole of what were considered to be the cultivated parts of Great Britain. The published date given below is often some years later than the surveyed date. Before 1938, all OS maps were based on the Cassini Projection, with independent surveys of a single county or group of counties, giving rise to significant inaccuracies in outlying areas.

Map Name(s) and Date(s)

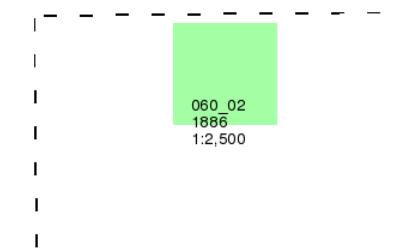

Historical Map - Segment F2

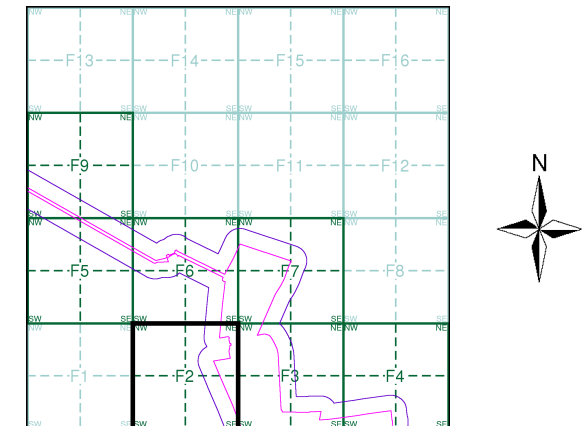

Order Details

Order Number: 298001007_1_1
 Customer Ref: 21-1098.04
 National Grid Reference: 486340, 380210
 Slice: F
 Site Area (Ha): 471.82
 Search Buffer (m): 100

Site Details

West Barton 1

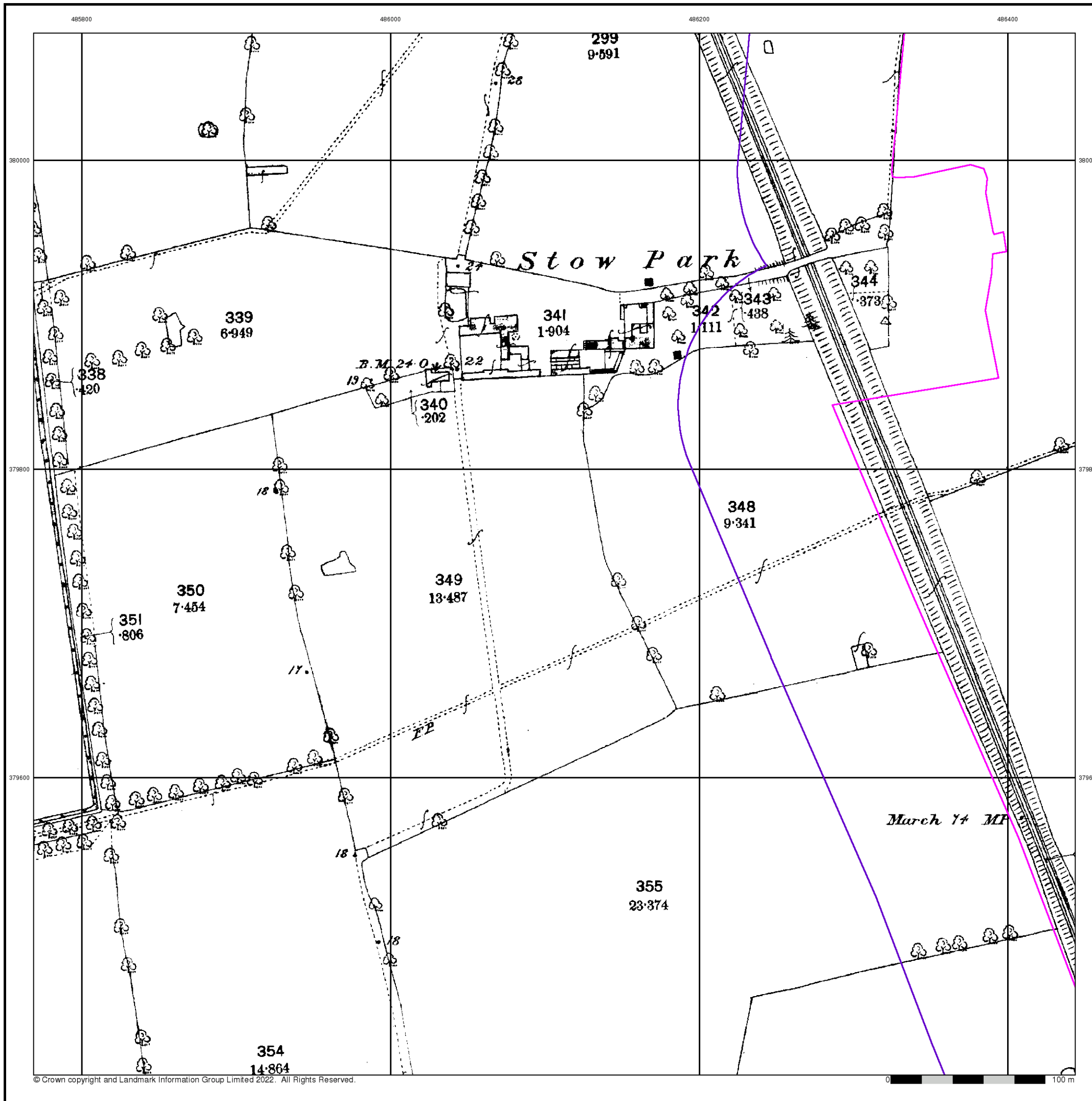

Lincolnshire

Published 1906

Source map scale - 1:2,500

The historical maps shown were reproduced from maps predominantly held at the scale adopted for England, Wales and Scotland in the 1840's. In 1854 the 1:2,500 scale was adopted for mapping urban areas and by 1896 it covered the whole of what were considered to be the cultivated parts of Great Britain. The published date given below is often some years later than the surveyed date. Before 1938, all OS maps were based on the Cassini Projection, with independent surveys of a single county or group of counties, giving rise to significant inaccuracies in outlying areas.

Map Name(s) and Date(s)

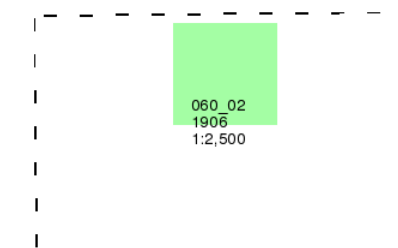

Historical Map - Segment F2

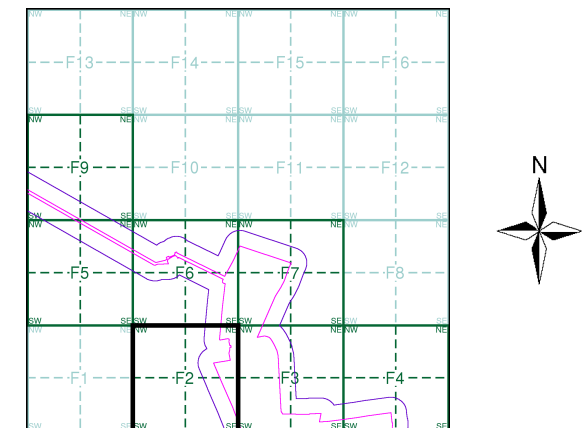

Order Details

Order Number: 298001007_1_1
 Customer Ref: 21-1098.04
 National Grid Reference: 486340, 380210
 Slice: F
 Site Area (Ha): 471.82
 Search Buffer (m): 100

Site Details

West Barton 1

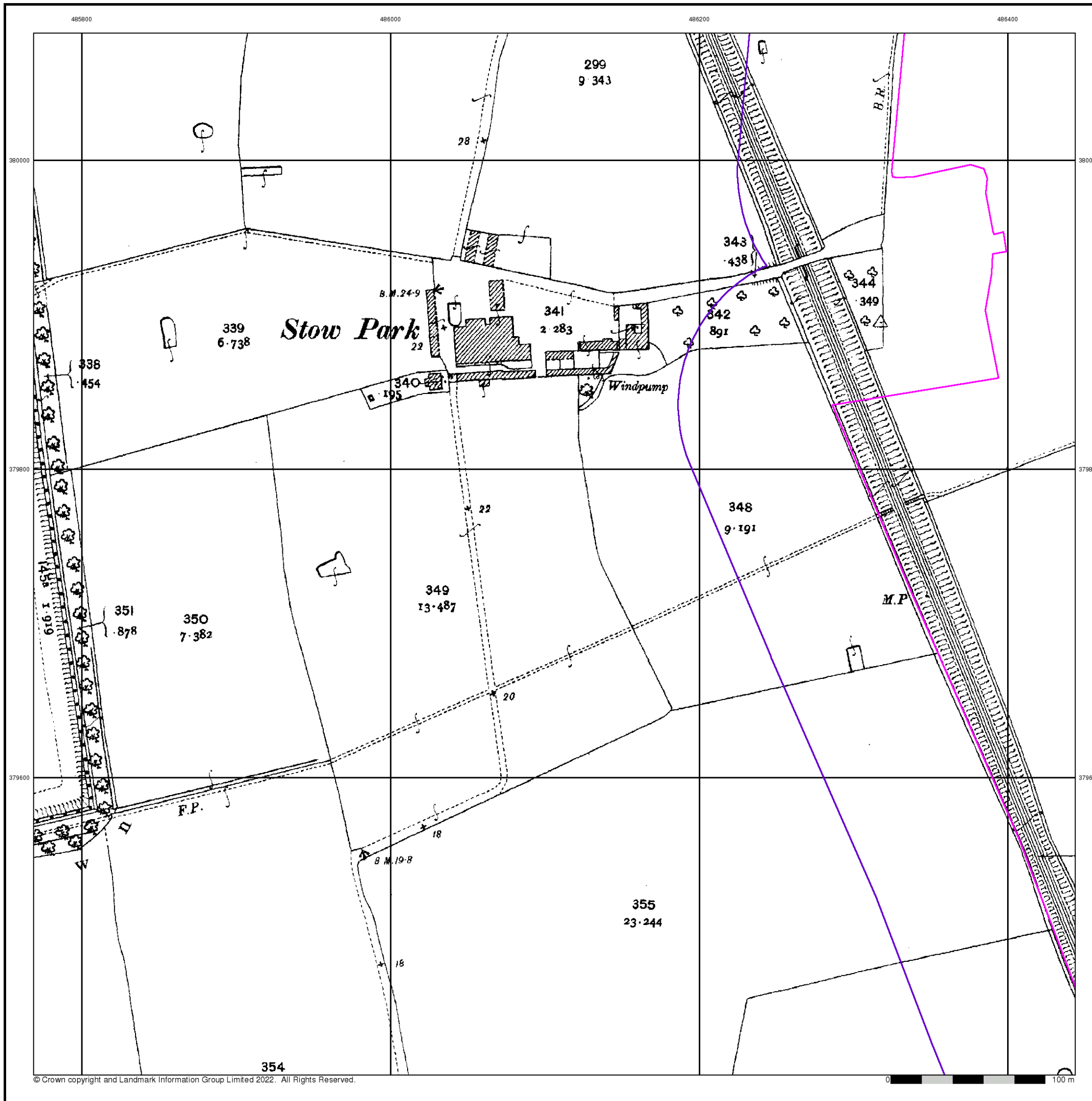

Lincolnshire

Published 1920

Source map scale - 1:2,500

The historical maps shown were reproduced from maps predominantly held at the scale adopted for England, Wales and Scotland in the 1840's. In 1854 the 1:2,500 scale was adopted for mapping urban areas and by 1896 it covered the whole of what were considered to be the cultivated parts of Great Britain. The published date given below is often some years later than the surveyed date. Before 1938, all OS maps were based on the Cassini Projection, with independent surveys of a single county or group of counties, giving rise to significant inaccuracies in outlying areas.

Map Name(s) and Date(s)

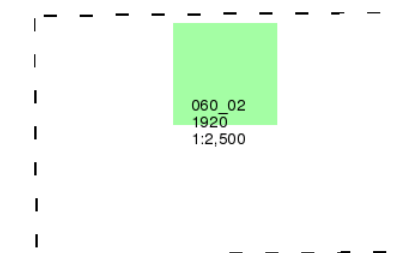

Historical Map - Segment F2

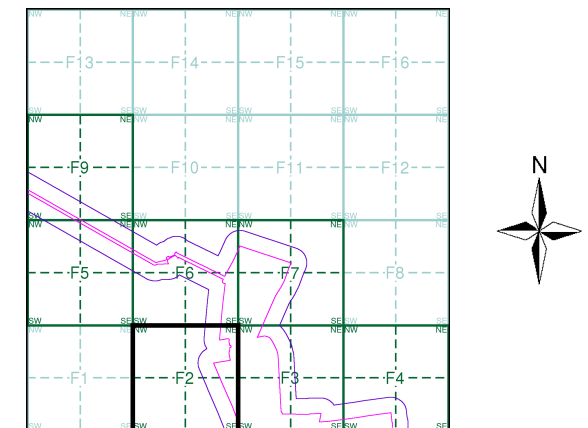

Order Details

Order Number: 298001007_1_1
 Customer Ref: 21-1098.04
 National Grid Reference: 486340, 380210
 Slice: F
 Site Area (Ha): 471.82
 Search Buffer (m): 100

Site Details

West Barton 1

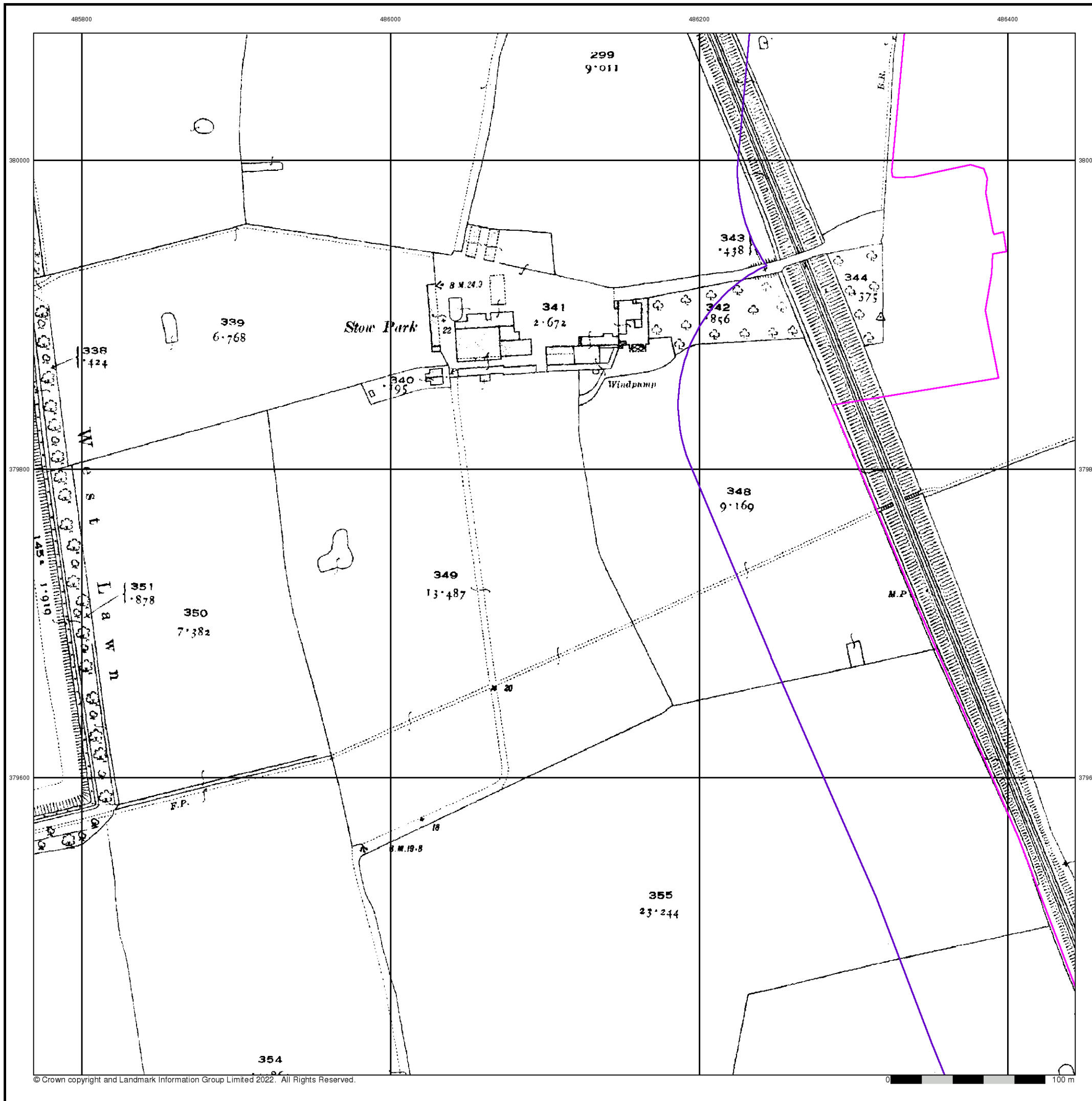

Ordnance Survey Plan
Published 1974 - 1975
Source map scale - 1:2,500

The historical maps shown were reproduced from maps predominantly held at the scale adopted for England, Wales and Scotland in the 1840's. In 1854 the 1:2,500 scale was adopted for mapping urban areas and by 1896 it covered the whole of what were considered to be the cultivated parts of Great Britain. The published date given below is often some years later than the surveyed date. Before 1938, all OS maps were based on the Cassini Projection, with independent surveys of a single county or group of counties, giving rise to significant inaccuracies in outlying areas.

Map Name(s) and Date(s)

SK8580 1974 1:2,500	SK8680 1975 1:2,500
SK8579 1974 1:2,500	SK8679 1975 1:2,500

Historical Map - Segment F2

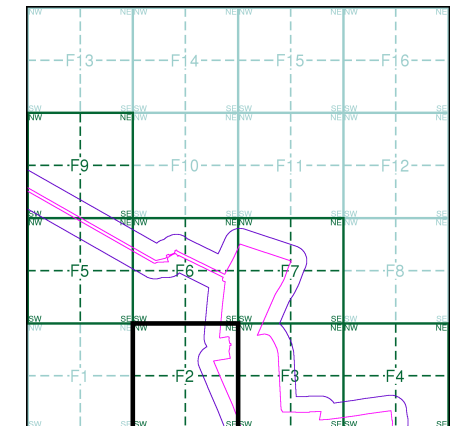

Order Details

Order Number: 298001007_1_1
 Customer Ref: 21-1098.04
 National Grid Reference: 486340, 380210
 Slice: F
 Site Area (Ha): 471.82
 Search Buffer (m): 100

Site Details

West Barton 1

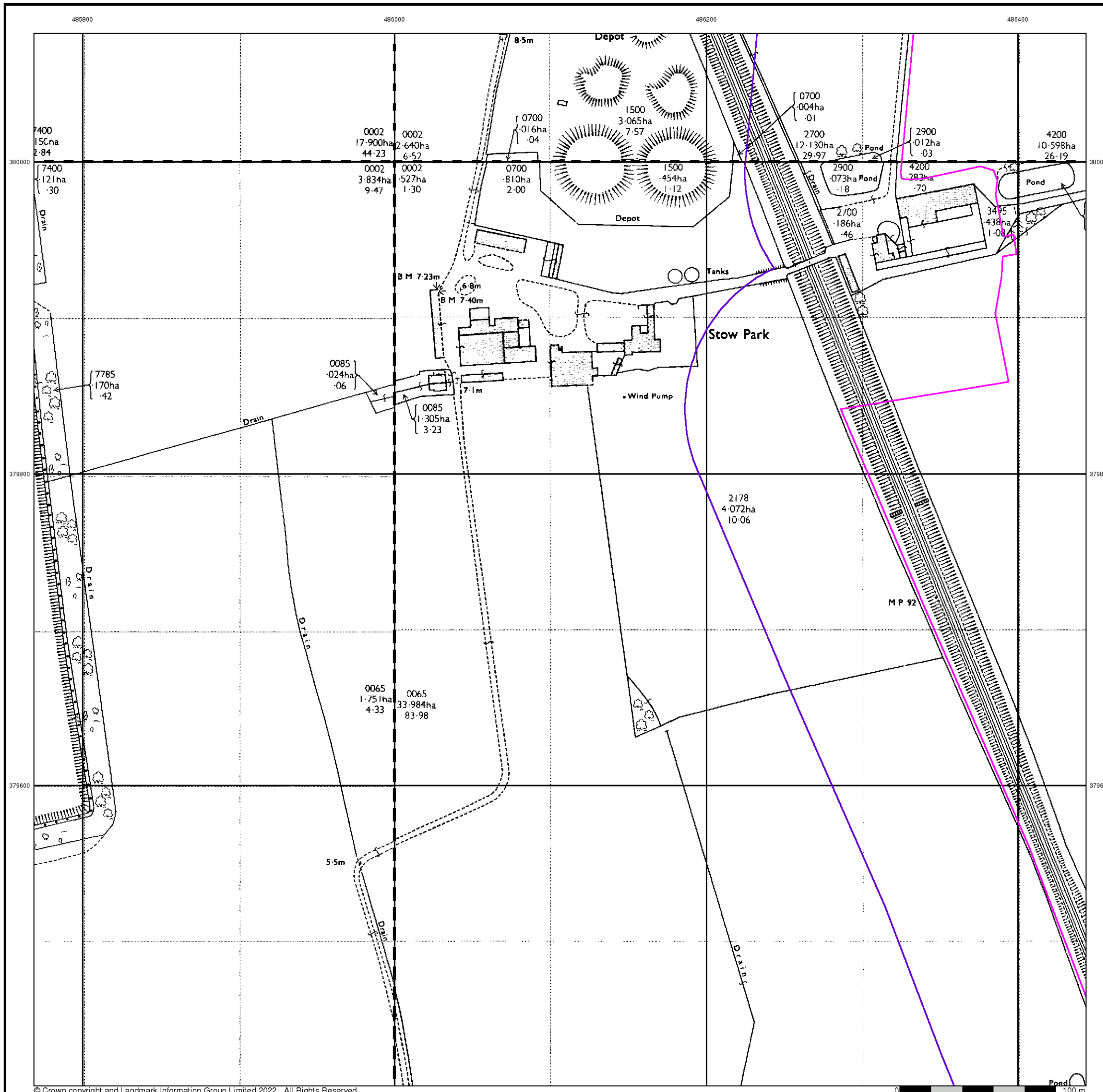

Large-Scale National Grid Data
Published 1994
Source map scale - 1:2,500

'Large Scale National Grid Data' superseded SIM cards (Ordnance Survey's 'Survey of Information on Microfilm') in 1992, and continued to be produced until 1999. These maps were the fore-runners of digital mapping and so provide detailed information on houses and roads, but tend to show less topographic features such as vegetation. These maps were produced at both 1:2,500 and 1:1,250 scales.

Map Name(s) and Date(s)

SK8580 1994 1:2,500	SK8680 1994 1:2,500
SK8579 1994 1:2,500	SK8679 1994 1:2,500

Historical Map - Segment F2

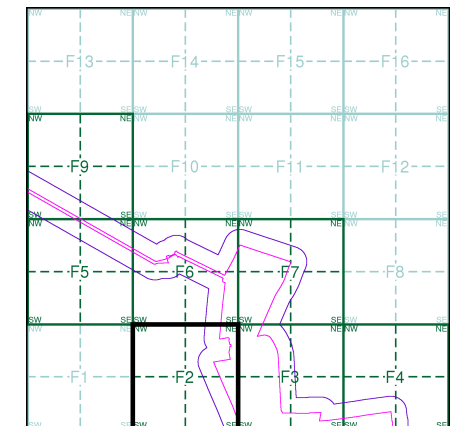

Order Details

Order Number: 298001007_1_1
 Customer Ref: 21-1098.04
 National Grid Reference: 486340, 380210
 Slice: F
 Site Area (Ha): 471.82
 Search Buffer (m): 100

Site Details

West Barton 1



Historical Mapping Legends

Ordnance Survey County Series and Ordnance Survey Plan 1:2,500

Quarry **Gravel Pit** **Sand Pit**
Clay Pit **Shingle** **Refuse Heap**
Sloping Masonry **Flat Rock**
Marsh **Reeds** **Osiers**
Rough Pasture **Furze** **Wood**
Mixed Wood **Brushwood** **Orchard**
Fir **Ford** **Stepping Stones**
Ferry **Waterfall** **Lock**
Trig. Station **Altitude at Trig. Station**
B.M. 325.9 **Bench Mark** **Surface Level**
Arrow denotes flow of water **Antiquities (site of)**
Cutting **Embankment**
Railway crossing Road **Level Crossing** **Road crossing Railway**
Railway crossing River or Canal **Road over single stream** **Road over River or Canal**
County Boundary (Geographical)
County & Civil Parish Boundary
Administrative County & Civil Parish Boundary
County Borough Boundary (England)
County Burgh Boundary (Scotland)
Boundary Post or Stone **Police Call Box**
B.R. Bridle Road **Pump**
E.P. Electricity Pylon **S.P. Signal Post**
F.B. Foot Bridge **Sl. Sluice**
F.P. Foot Path **Sp. Spring**
G.P. Guide Post or Board **T.C.B. Telephone Call Box**
M.S. Mile Stone **Tr. Trough**
M.P. M.R. Mooring Post or Ring **W. Well**

Ordnance Survey Plan, Additional SIMs and Supply of Unpublished Survey Information 1:2,500 and 1:1,250

Inactive Quarry, Chalk Pit or Clay Pit **Active Quarry, Chalk Pit or Clay Pit**
Rock **Boulders**
Cliff **Slopes** **Top**
Roofed Building **Glazed Roof Building**
Sloping Masonry **Archway**
Non-Coniferous Tree (surveyed) **Coniferous Tree (surveyed)**
Non-Coniferous Trees (not surveyed) **Coniferous Trees (not surveyed)**
Orchard Tree **Scrub** **Bracken**
Coppice, Osier **Reeds** **Marsh, Saltings**
Rough Grassland **Heath** **Culvert**
Direction of water flow **Bench Mark** **Antiquity (site of)**
Cave Entrance **Triangulation Station** **Electricity Pylon**
Electricity Transmission Line
County Boundary (Geographical)
County & Civil Parish Boundary
Civil Parish Boundary
Admin. County or County Bor. Boundary
London Borough Boundary
Symbol marking point where boundary mereing changes
Beer House **Pillar, Pole or Post**
Boundary Post or Stone **Post Office**
Capstan, Crane **Public Convenience**
Chimney **Public House**
Drinking Fountain **Pump**
Electricity Pillar or Post **Signal Box or Bridge**
Fire Alarm Pillar **Signal Post or Light**
Foot Bridge **Spring**
Guide Post **Tank or Track**
Hydrant or Hydraulic **Telephone Call Box**
Level Crossing **Telephone Call Post**
Manhole **Trough**
Mile Post or Mooring Post **Water Point, Water Tap**
Mile Stone **Well**
Normal Tidal Limit **Wind Pump**

Large-Scale National Grid Data 1:2,500 and 1:1,250

Cliff **Slopes** **Top**
Rock **Rock (scattered)**
Boulders **Boulders (scattered)**
Positioned Boulder **Scree**
Non-Coniferous Tree (surveyed) **Coniferous Tree (surveyed)**
Non-Coniferous Trees (not surveyed) **Coniferous Trees (not surveyed)**
Orchard Tree **Scrub** **Bracken**
Coppice, Osier **Reeds** **Marsh, Saltings**
Rough Grassland **Heath** **Culvert**
Direction of water flow **Triangulation Station** **Antiquity (site of)**
Electricity Transmission Line **Electricity Pylon**
Bench Mark **Buildings with Building Seed**
Roofed Building **Glazed Roof Building**
Civil parish/community boundary
District boundary
County boundary
Boundary post/stone
Boundary mereing symbol (note: these always appear in opposed pairs or groups of three)
Barracks **Pillar, Pole or Post**
Battery **Post Office**
Cemetery **Public Convenience**
Chimney **Pump**
Cistern **Pumping Station**
Dismtd Rly **Place of Worship**
Electricity Generating Station **Sewage Ppg Sta** **Sewage Pumping Station**
Electricity Pole, Pillar **Signal Box or Bridge**
Electricity Sub Station **Signal Post or Light**
Filter Bed **Spring**
Fountain / Drinking Ftn. **Tank or Track**
Gas Valve Compound **Trough**
Gas Governor **Wind Pump**
Guide Post **Water Point, Water Tap**
Manhole **Works (building or area)**
Mile Post or Mile Stone **Well**



Historical Mapping & Photography included:

Mapping Type	Scale	Date	Pg
Lincolnshire	1:2,500	1886	2
Lincolnshire	1:2,500	1906	3
Lincolnshire	1:2,500	1920	4
Ordnance Survey Plan	1:2,500	1975	5
Large-Scale National Grid Data	1:2,500	1994	6

Historical Map - Segment F3

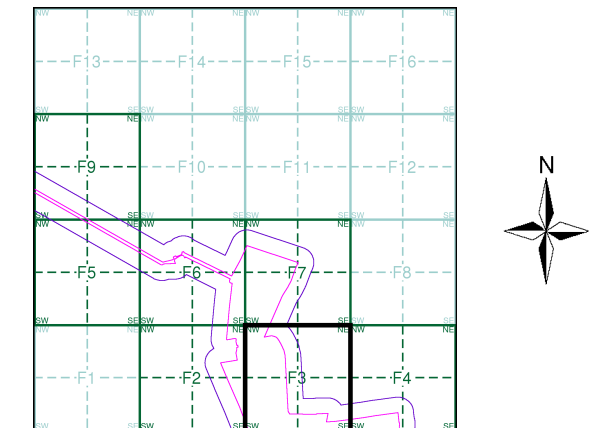

Order Details

Order Number: 298001007_1_1
 Customer Ref: 21-1098.04
 National Grid Reference: 486340, 380210
 Slice: F
 Site Area (Ha): 471.82
 Search Buffer (m): 100

Site Details

West Barton 1



Tel: 0844 844 9952
 Fax: 0844 844 9951
 Web: [REDACTED]

Lincolnshire

Published 1886

Source map scale - 1:2,500

The historical maps shown were reproduced from maps predominantly held at the scale adopted for England, Wales and Scotland in the 1840's. In 1854 the 1:2,500 scale was adopted for mapping urban areas and by 1896 it covered the whole of what were considered to be the cultivated parts of Great Britain. The published date given below is often some years later than the surveyed date. Before 1938, all OS maps were based on the Cassini Projection, with independent surveys of a single county or group of counties, giving rise to significant inaccuracies in outlying areas.

Map Name(s) and Date(s)

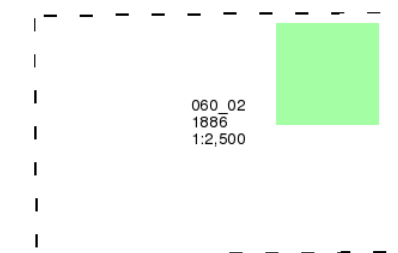

Historical Map - Segment F3

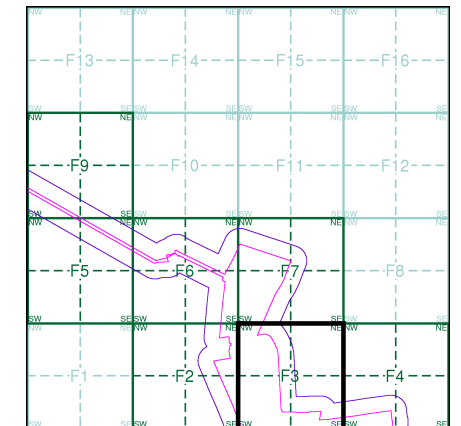

Order Details

Order Number: 298001007_1_1
 Customer Ref: 21-1098.04
 National Grid Reference: 486340, 380210
 Slice: F
 Site Area (Ha): 471.82
 Search Buffer (m): 100

Site Details

West Barton 1

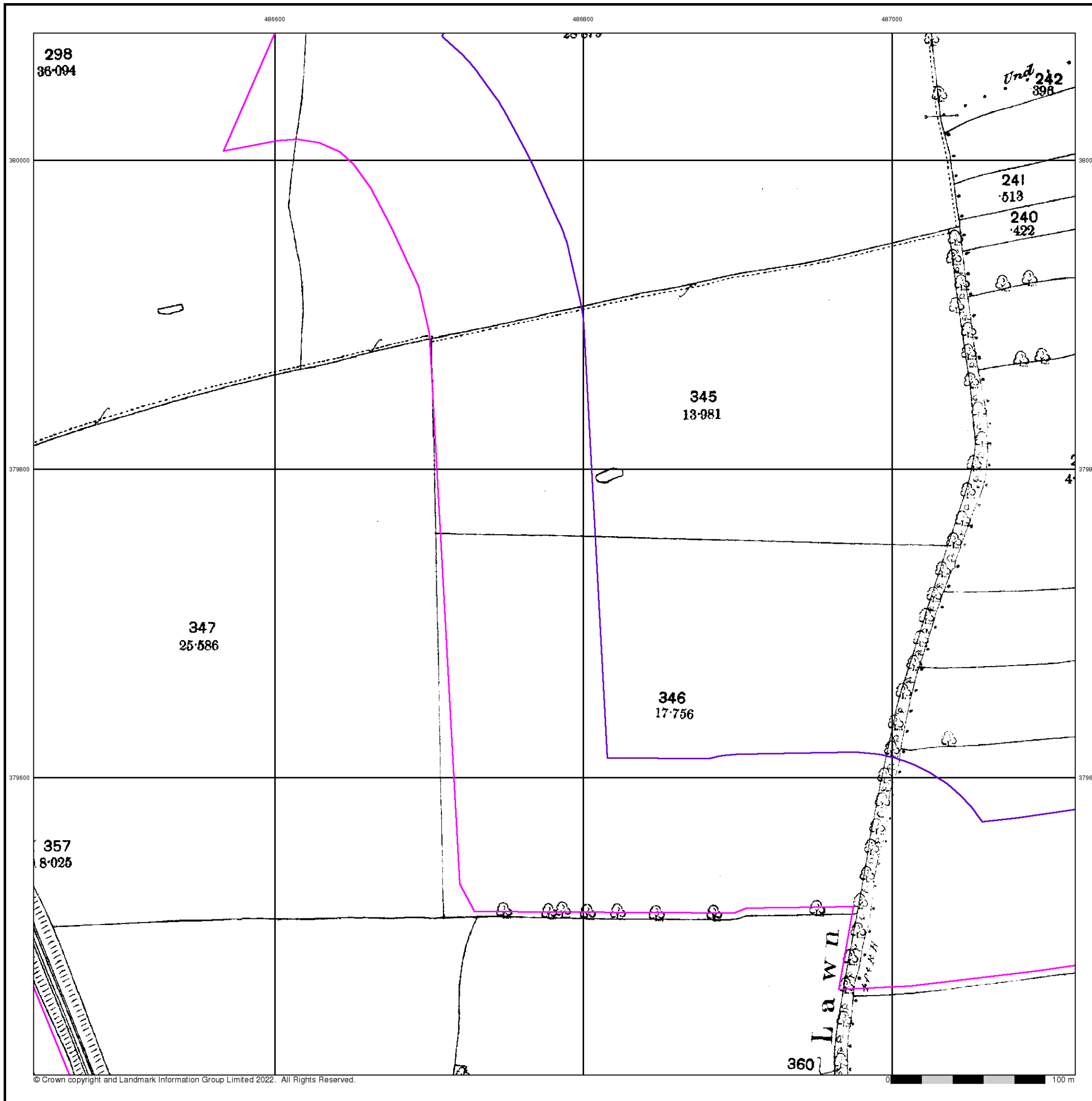

Lincolnshire
Published 1906

Source map scale - 1:2,500

The historical maps shown were reproduced from maps predominantly held at the scale adopted for England, Wales and Scotland in the 1840's. In 1854 the 1:2,500 scale was adopted for mapping urban areas and by 1896 it covered the whole of what were considered to be the cultivated parts of Great Britain. The published date given below is often some years later than the surveyed date. Before 1938, all OS maps were based on the Cassini Projection, with independent surveys of a single county or group of counties, giving rise to significant inaccuracies in outlying areas.

Map Name(s) and Date(s)

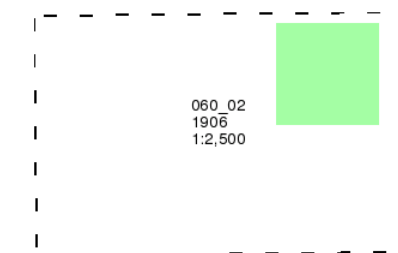

Historical Map - Segment F3

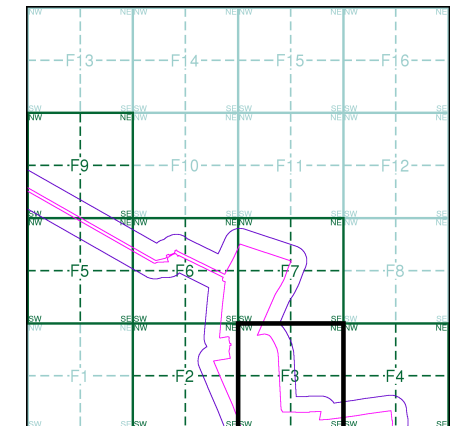

Order Details

Order Number: 298001007_1_1
 Customer Ref: 21-1098.04
 National Grid Reference: 486340, 380210
 Slice: F
 Site Area (Ha): 471.82
 Search Buffer (m): 100

Site Details

West Barton 1

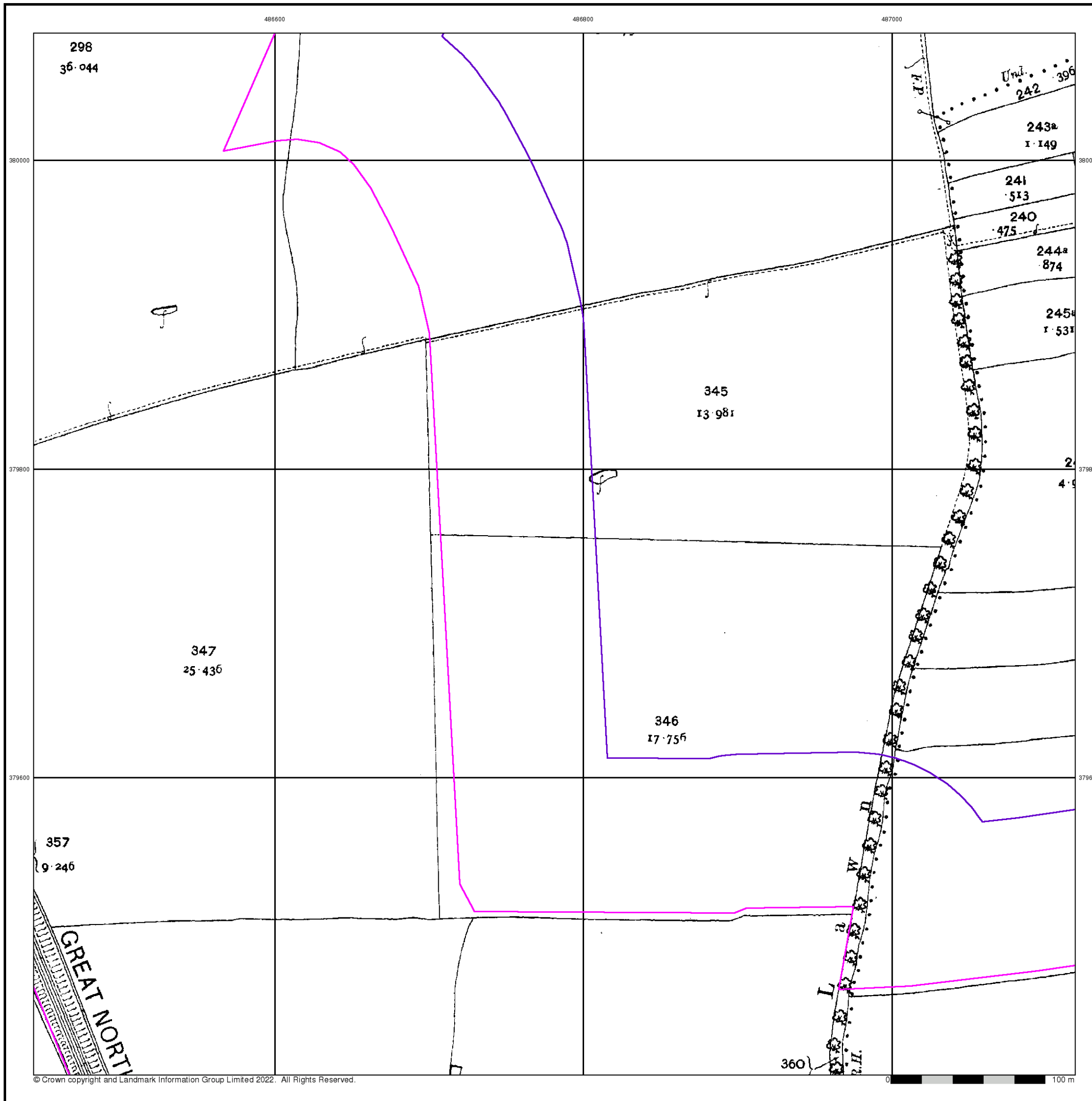

Lincolnshire

Published 1920

Source map scale - 1:2,500

The historical maps shown were reproduced from maps predominantly held at the scale adopted for England, Wales and Scotland in the 1840's. In 1854 the 1:2,500 scale was adopted for mapping urban areas and by 1896 it covered the whole of what were considered to be the cultivated parts of Great Britain. The published date given below is often some years later than the surveyed date. Before 1938, all OS maps were based on the Cassini Projection, with independent surveys of a single county or group of counties, giving rise to significant inaccuracies in outlying areas.

Map Name(s) and Date(s)

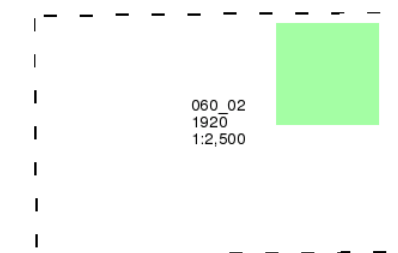

Historical Map - Segment F3

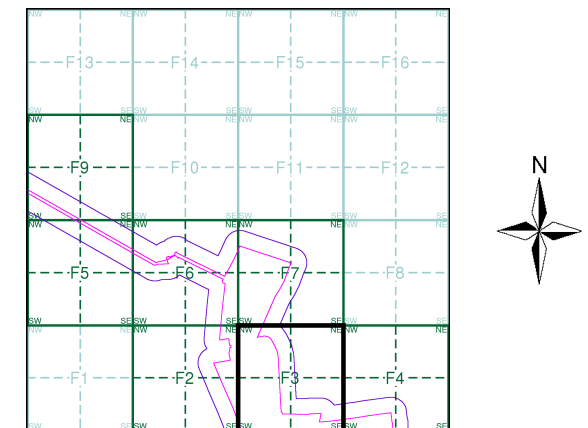

Order Details

Order Number: 298001007_1_1
 Customer Ref: 21-1098.04
 National Grid Reference: 486340, 380210
 Slice: F
 Site Area (Ha): 471.82
 Search Buffer (m): 100

Site Details

West Barton 1

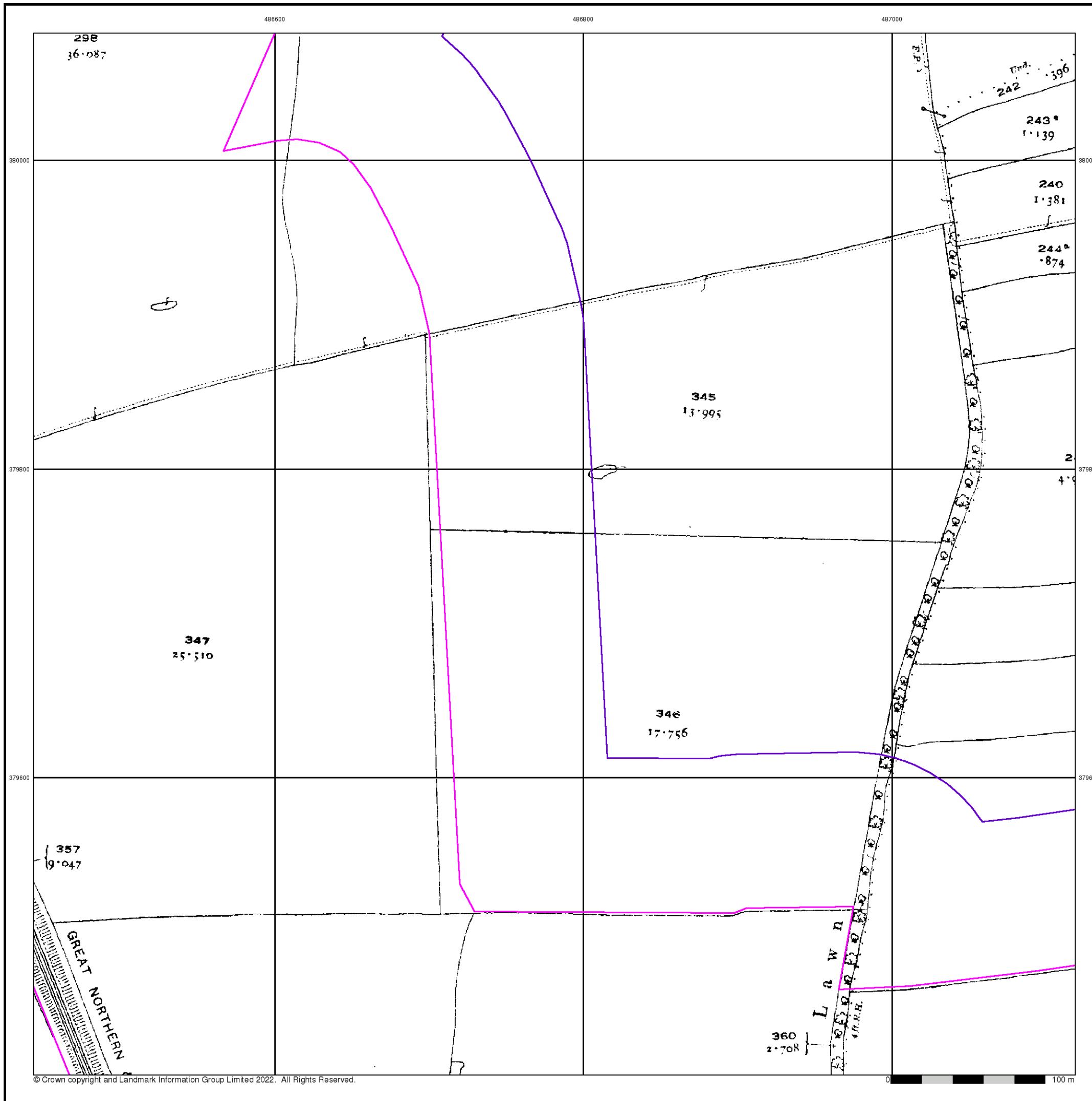

Ordnance Survey Plan

Published 1975

Source map scale - 1:2,500

The historical maps shown were reproduced from maps predominantly held at the scale adopted for England, Wales and Scotland in the 1840's. In 1854 the 1:2,500 scale was adopted for mapping urban areas and by 1896 it covered the whole of what were considered to be the cultivated parts of Great Britain. The published date given below is often some years later than the surveyed date. Before 1938, all OS maps were based on the Cassini Projection, with independent surveys of a single county or group of counties, giving rise to significant inaccuracies in outlying areas.

Map Name(s) and Date(s)

SK8680 1975 12,500	SK8780 1975 12,500
SK8679 1975 12,500	SK8779 1975 12,500

Historical Map - Segment F3

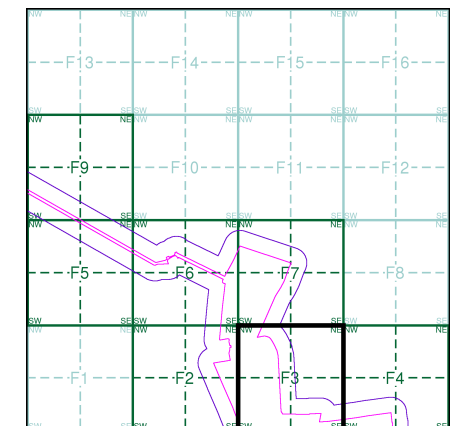

Order Details

Order Number: 298001007_1_1
 Customer Ref: 21-1098.04
 National Grid Reference: 486340, 380210
 Slice: F
 Site Area (Ha): 471.82
 Search Buffer (m): 100

Site Details

West Barton 1

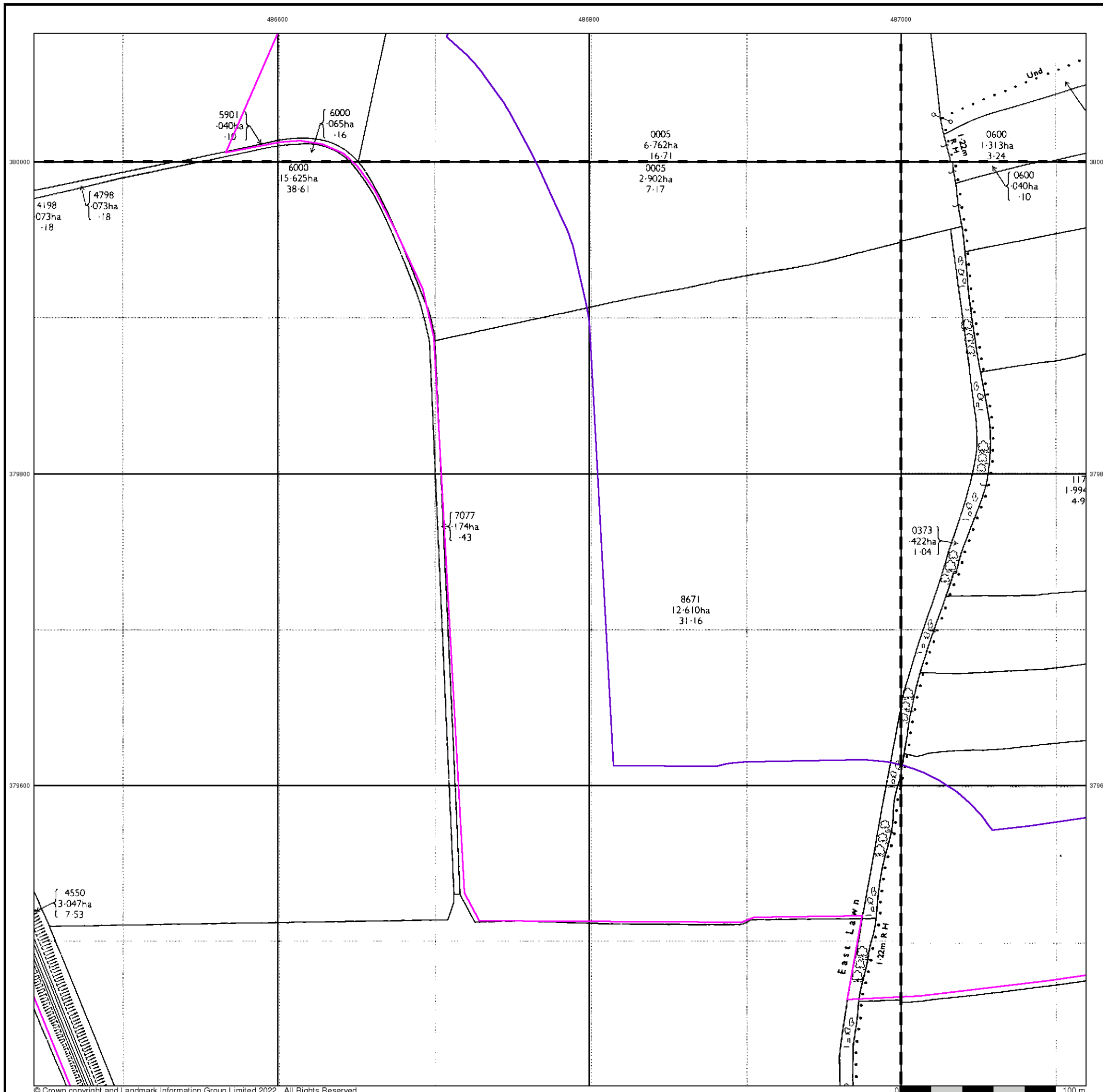

Large-Scale National Grid Data

Published 1994

Source map scale - 1:2,500

'Large Scale National Grid Data' superseded SIM cards (Ordnance Survey's 'Survey of Information on Microfilm') in 1992, and continued to be produced until 1999. These maps were the fore-runners of digital mapping and so provide detailed information on houses and roads, but tend to show less topographic features such as vegetation. These maps were produced at both 1:2,500 and 1:1,250 scales.

Map Name(s) and Date(s)

SK8680	SK8780
1994	1994
12,500	12,500
SK8679	SK8779
1994	1994
12,500	12,500

Historical Map - Segment F3

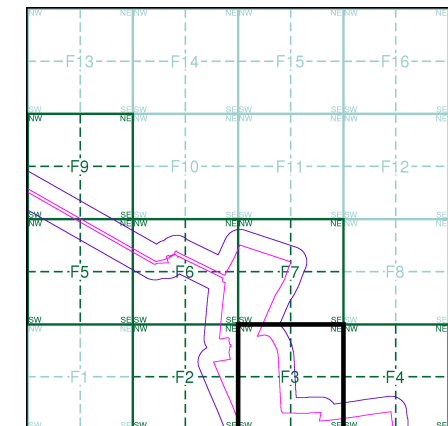

Order Details

Order Number: 298001007_1_1
 Customer Ref: 21-1098.04
 National Grid Reference: 486340, 380210
 Slice: F
 Site Area (Ha): 471.82
 Search Buffer (m): 100

Site Details

West Barton 1

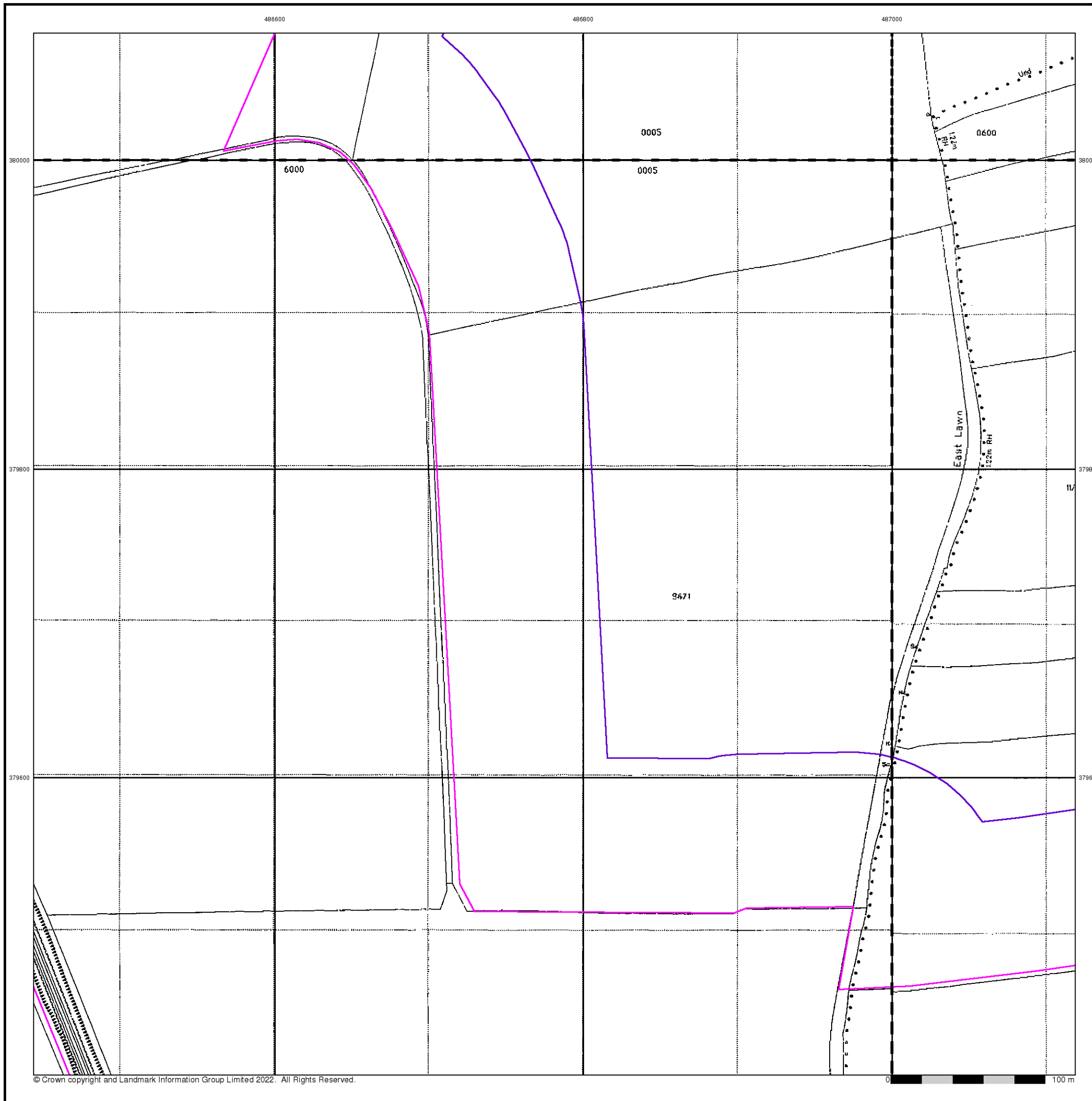

Historical Mapping Legends

Ordnance Survey County Series and Ordnance Survey Plan 1:2,500

Quarry **Gravel Pit** **Sand Pit**
Clay Pit **Shingle** **Refuse Heap**
Sloping Masonry **Flat Rock**
Marsh **Reeds** **Osiers**
Rough Pasture **Furze** **Wood**
Mixed Wood **Brushwood** **Orchard**
Fir **Ford** **Stepping Stones**
Ferry **Waterfall** **Lock**
Trig. Station **Altitude at Trig. Station**
B.M. 325.9 **Bench Mark** **Surface Level**
Arrow denotes flow of water **Antiquities (site of)**
Cutting **Embankment**
Railway crossing Road **Level Crossing** **Road crossing Railway**
Railway crossing River or Canal **Road over single stream** **Road over River or Canal**
County Boundary (Geographical)
County & Civil Parish Boundary
Administrative County & Civil Parish Boundary
County Borough Boundary (England)
County Burgh Boundary (Scotland)
Boundary Post or Stone **Police Call Box**
B.R. Bridle Road **Pump**
E.P. Electricity Pylon **S.P. Signal Post**
F.B. Foot Bridge **Sl. Sluice**
F.P. Foot Path **Sp. Spring**
G.P. Guide Post or Board **T.C.B. Telephone Call Box**
M.S. Mile Stone **Tr. Trough**
M.P. M.R. Mooring Post or Ring **W. Well**

Ordnance Survey Plan, Additional SIMs and Supply of Unpublished Survey Information 1:2,500 and 1:1,250

Inactive Quarry, Chalk Pit or Clay Pit **Active Quarry, Chalk Pit or Clay Pit**
Rock **Boulders**
Cliff **Slopes** **Top**
Roofed Building **Glazed Roof Building**
Sloping Masonry **Archway**
Non-Coniferous Tree (surveyed) **Coniferous Tree (surveyed)**
Non-Coniferous Trees (not surveyed) **Coniferous Trees (not surveyed)**
Orchard Tree **Scrub** **Bracken**
Coppice, Osier **Reeds** **Marsh, Saltings**
Rough Grassland **Heath** **Culvert**
Direction of water flow **Bench Mark** **Antiquity (site of)**
Cave Entrance **Triangulation Station** **Electricity Pylon**
Electricity Transmission Line
County Boundary (Geographical)
County & Civil Parish Boundary
Civil Parish Boundary
Admin. County or County Bor. Boundary
London Borough Boundary
Symbol marking point where boundary mereing changes
Beer House **Pillar, Pole or Post**
Boundary Post or Stone **Post Office**
Capstan, Crane **Public Convenience**
Chimney **Public House**
Drinking Fountain **Pump**
Electricity Pillar or Post **Signal Box or Bridge**
Fire Alarm Pillar **Signal Post or Light**
Foot Bridge **Spring**
Guide Post **Tank or Track**
Hydrant or Hydraulic **Telephone Call Box**
Level Crossing **Telephone Call Post**
Manhole **Trough**
Mile Post or Mooring Post **Water Point, Water Tap**
Mile Stone **Well**
Normal Tidal Limit **Wind Pump**

Large-Scale National Grid Data 1:2,500 and 1:1,250

Cliff **Slopes** **Top**
Rock **Rock (scattered)**
Boulders **Boulders (scattered)**
Positioned Boulder **Scree**
Non-Coniferous Tree (surveyed) **Coniferous Tree (surveyed)**
Non-Coniferous Trees (not surveyed) **Coniferous Trees (not surveyed)**
Orchard Tree **Scrub** **Bracken**
Coppice, Osier **Reeds** **Marsh, Saltings**
Rough Grassland **Heath** **Culvert**
Direction of water flow **Triangulation Station** **Antiquity (site of)**
Electricity Transmission Line **Electricity Pylon**
Bench Mark **Buildings with Building Seed**
Roofed Building **Glazed Roof Building**
Civil parish/community boundary
District boundary
County boundary
Boundary post/stone
Boundary mereing symbol (note: these always appear in opposed pairs or groups of three)
Barracks **Pillar, Pole or Post**
Battery **Post Office**
Cemetery **Public Convenience**
Chimney **Pump**
Cistern **Pumping Station**
Dismtd Rly **Place of Worship**
Electricity Generating Station **Sewage Ppg Sta** **Sewage Pumping Station**
Electricity Pole, Pillar **Signal Box or Bridge**
Electricity Sub Station **Signal Post or Light**
Filter Bed **Spring**
Fountain / Drinking Ftn. **Tank or Track**
Gas Valve Compound **Trough**
Gas Governor **Wind Pump**
Guide Post **Water Point, Water Tap**
Manhole **Works (building or area)**
Mile Post or Mile Stone **Well**



Historical Mapping & Photography included:

Mapping Type	Scale	Date	Pg
Lincolnshire	1:2,500	1886	2
Lincolnshire	1:2,500	1906	3
Lincolnshire	1:2,500	1920	4
Ordnance Survey Plan	1:2,500	1975	5
Large-Scale National Grid Data	1:2,500	1994	6

Historical Map - Segment F4

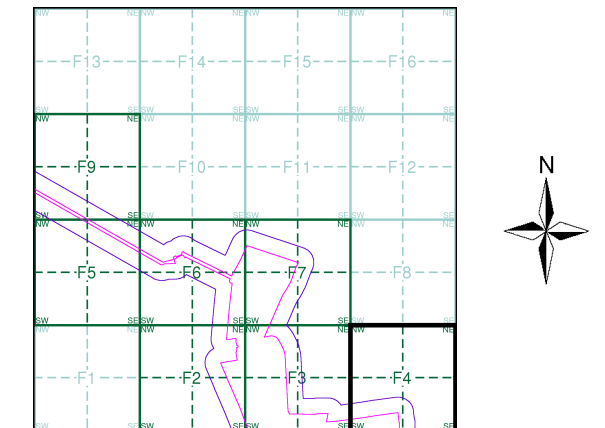

Order Details

Order Number: 298001007_1_1
 Customer Ref: 21-1098.04
 National Grid Reference: 486340, 380210
 Slice: F
 Site Area (Ha): 471.82
 Search Buffer (m): 100

Site Details

West Barton 1



Tel: 0844 844 9952
 Fax: 0844 844 9951
 Web: [REDACTED]

Lincolnshire

Published 1886

Source map scale - 1:2,500

The historical maps shown were reproduced from maps predominantly held at the scale adopted for England, Wales and Scotland in the 1840's. In 1854 the 1:2,500 scale was adopted for mapping urban areas and by 1896 it covered the whole of what were considered to be the cultivated parts of Great Britain. The published date given below is often some years later than the surveyed date. Before 1938, all OS maps were based on the Cassini Projection, with independent surveys of a single county or group of counties, giving rise to significant inaccuracies in outlying areas.

Map Name(s) and Date(s)

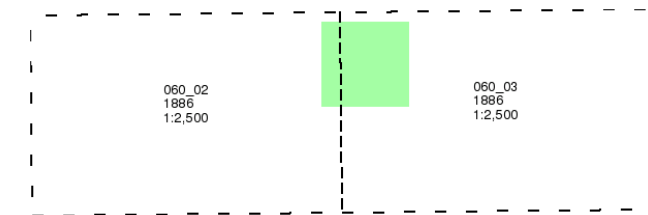

Historical Map - Segment F4

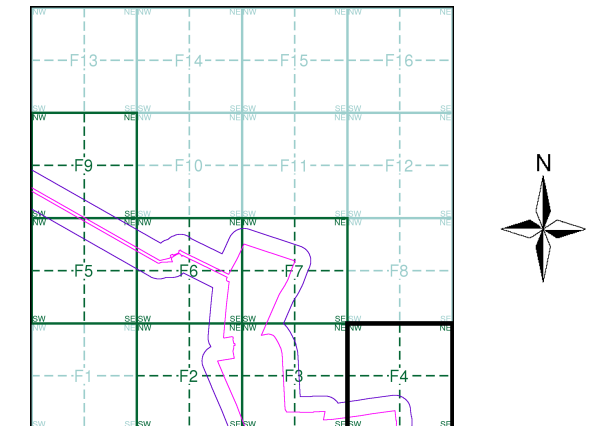

Order Details

Order Number: 298001007_1_1
 Customer Ref: 21-1098.04
 National Grid Reference: 486340, 380210
 Slice: F
 Site Area (Ha): 471.82
 Search Buffer (m): 100

Site Details

West Barton 1

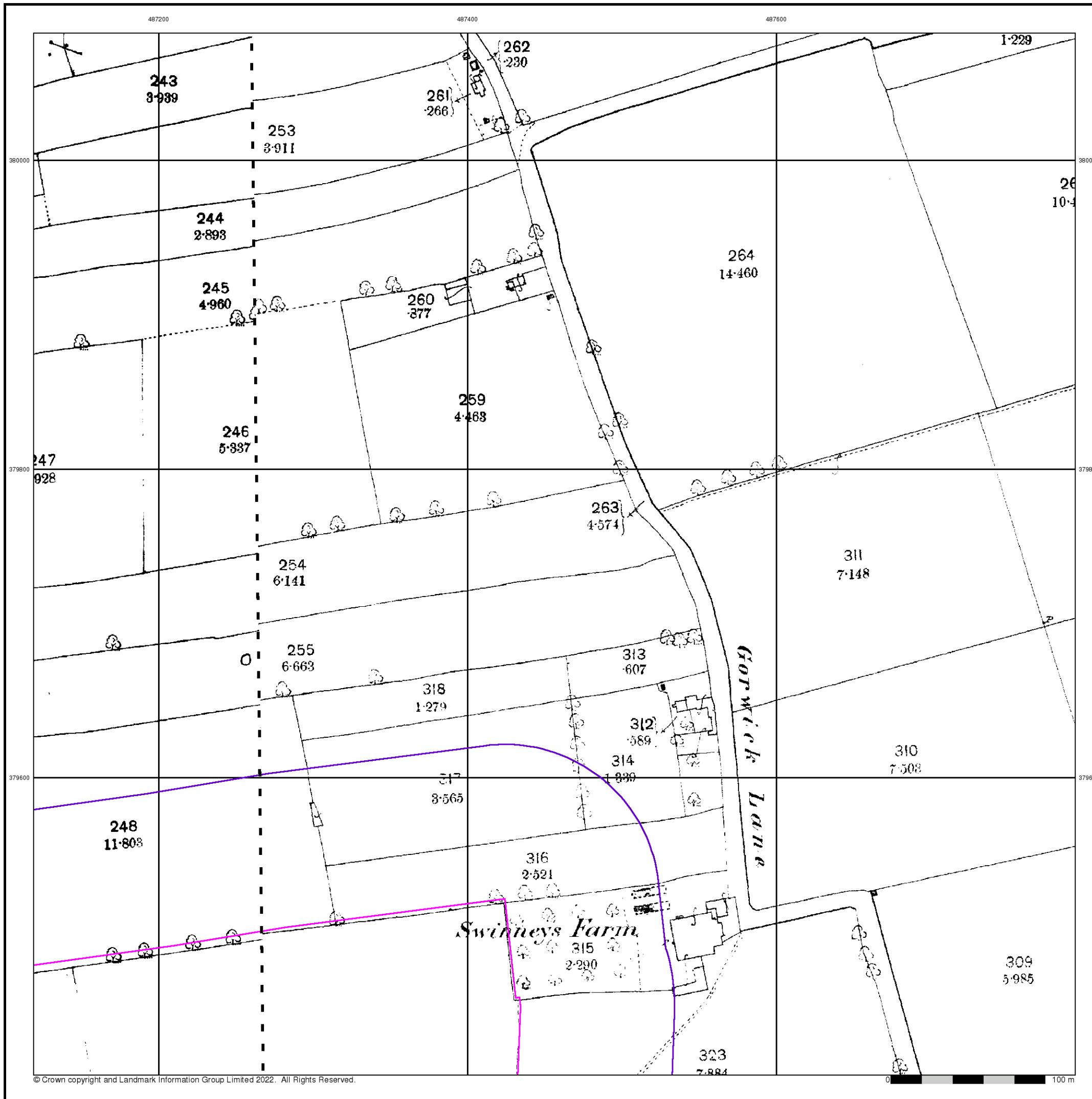

Lincolnshire

Published 1906

Source map scale - 1:2,500

The historical maps shown were reproduced from maps predominantly held at the scale adopted for England, Wales and Scotland in the 1840's. In 1854 the 1:2,500 scale was adopted for mapping urban areas and by 1896 it covered the whole of what were considered to be the cultivated parts of Great Britain. The published date given below is often some years later than the surveyed date. Before 1938, all OS maps were based on the Cassini Projection, with independent surveys of a single county or group of counties, giving rise to significant inaccuracies in outlying areas.

Map Name(s) and Date(s)

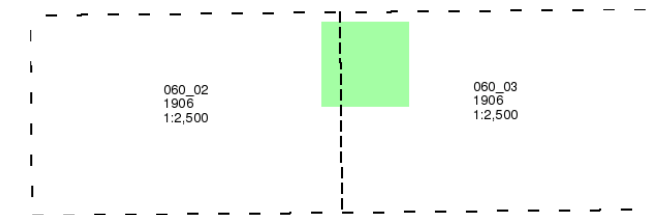

Historical Map - Segment F4

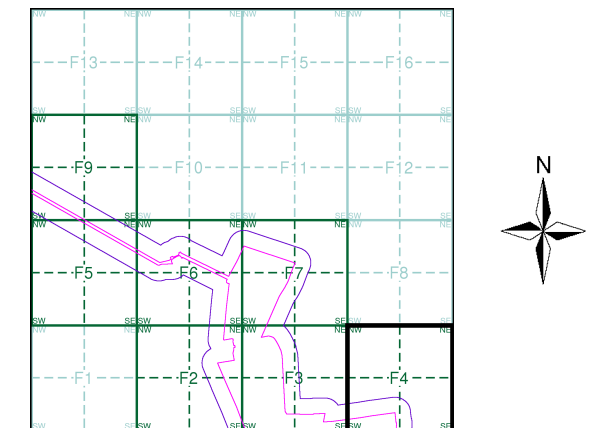

Order Details

Order Number: 298001007_1_1
 Customer Ref: 21-1098.04
 National Grid Reference: 486340, 380210
 Slice: F
 Site Area (Ha): 471.82
 Search Buffer (m): 100

Site Details

West Barton 1

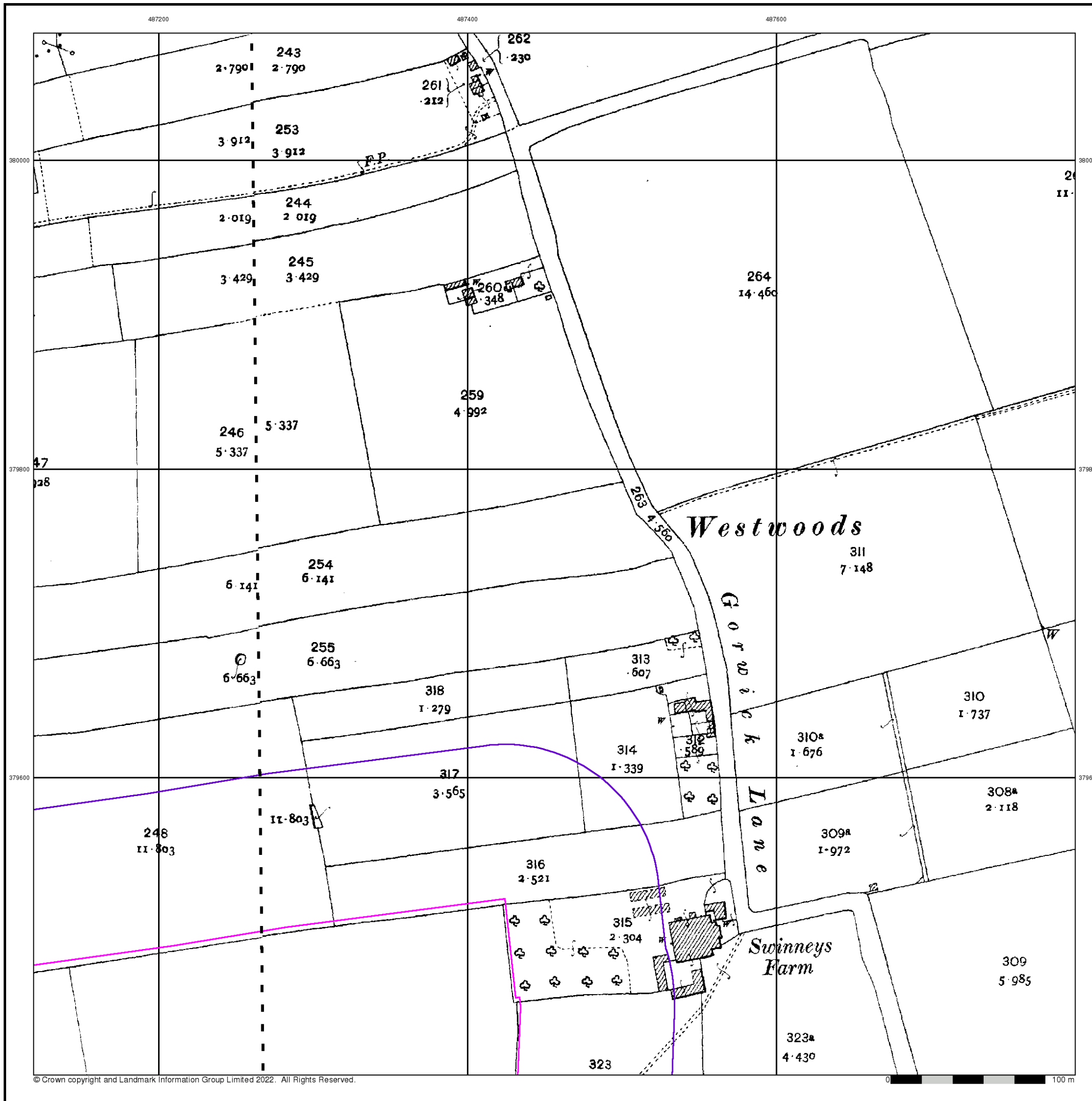

Lincolnshire
Published 1920

Source map scale - 1:2,500

The historical maps shown were reproduced from maps predominantly held at the scale adopted for England, Wales and Scotland in the 1840's. In 1854 the 1:2,500 scale was adopted for mapping urban areas and by 1896 it covered the whole of what were considered to be the cultivated parts of Great Britain. The published date given below is often some years later than the surveyed date. Before 1938, all OS maps were based on the Cassini Projection, with independent surveys of a single county or group of counties, giving rise to significant inaccuracies in outlying areas.

Map Name(s) and Date(s)

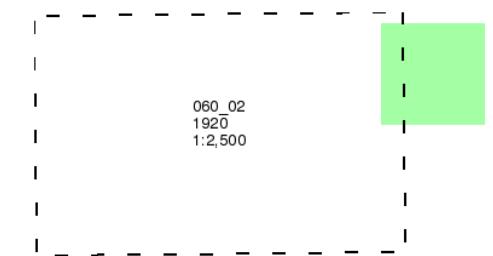

Historical Map - Segment F4

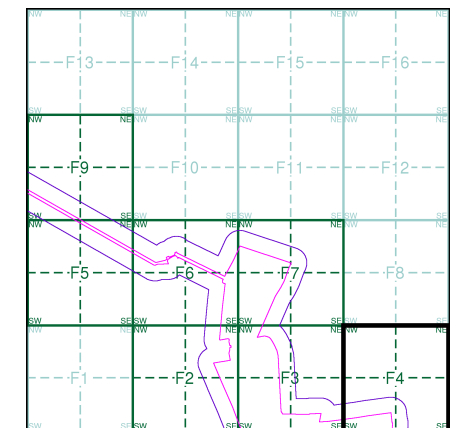

Order Details

Order Number: 298001007_1_1
 Customer Ref: 21-1098.04
 National Grid Reference: 486340, 380210
 Slice: F
 Site Area (Ha): 471.82
 Search Buffer (m): 100

Site Details

West Barton 1

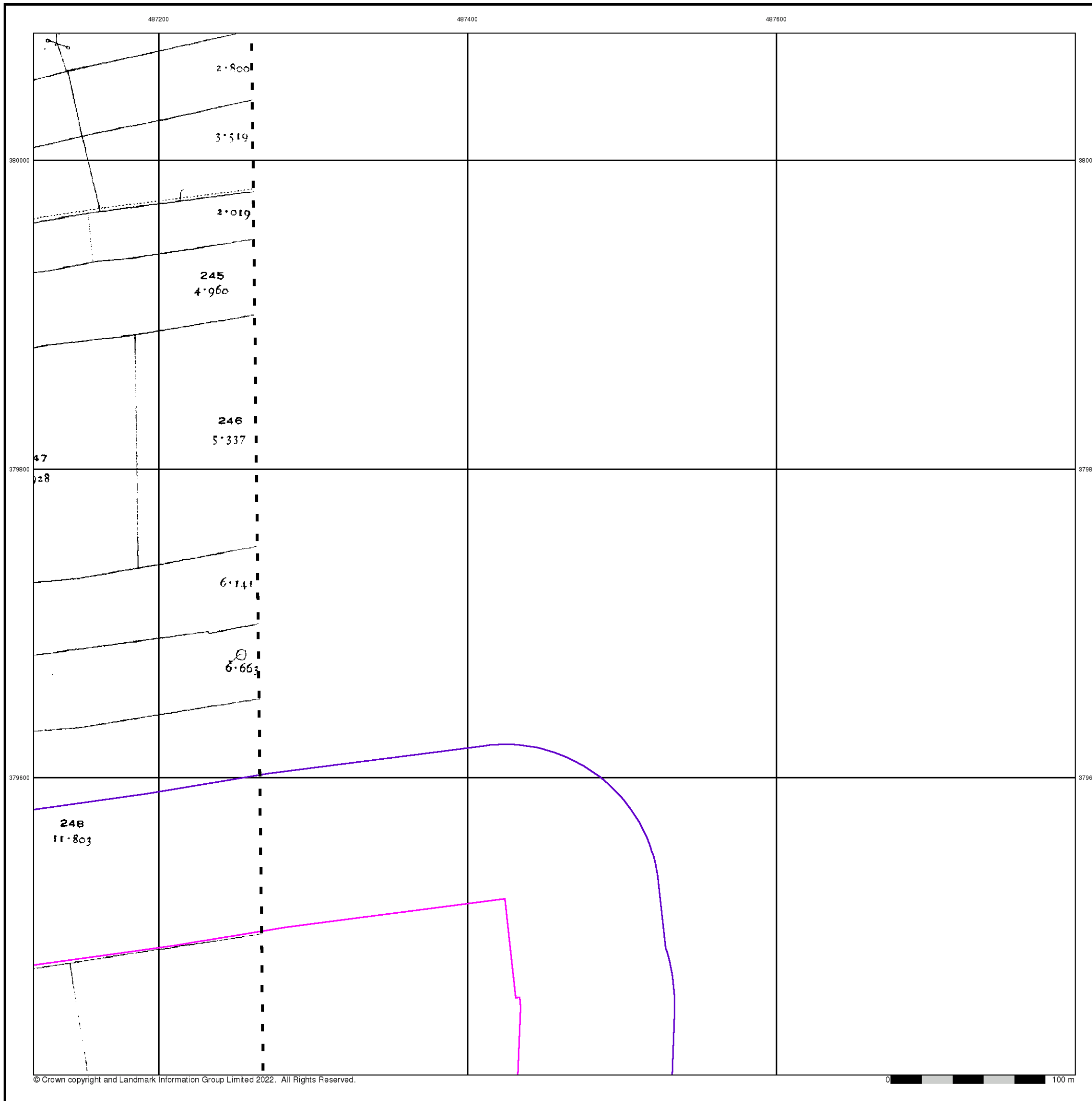

Ordnance Survey Plan

Published 1975

Source map scale - 1:2,500

The historical maps shown were reproduced from maps predominantly held at the scale adopted for England, Wales and Scotland in the 1840's. In 1854 the 1:2,500 scale was adopted for mapping urban areas and by 1896 it covered the whole of what were considered to be the cultivated parts of Great Britain. The published date given below is often some years later than the surveyed date. Before 1938, all OS maps were based on the Cassini Projection, with independent surveys of a single county or group of counties, giving rise to significant inaccuracies in outlying areas.

Map Name(s) and Date(s)

SK8780	1975	1:2,500
SK8779	1975	1:2,500

Historical Map - Segment F4

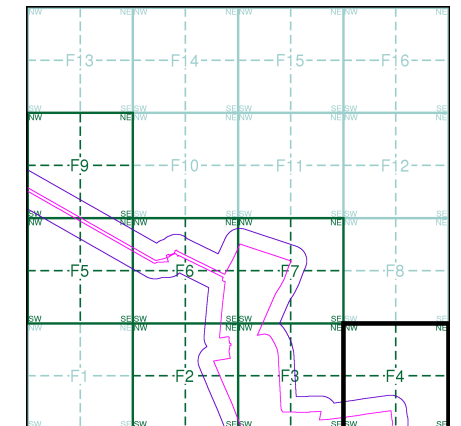

Order Details

Order Number: 298001007_1_1
 Customer Ref: 21-1098.04
 National Grid Reference: 486340, 380210
 Slice: F
 Site Area (Ha): 471.82
 Search Buffer (m): 100

Site Details

West Barton 1

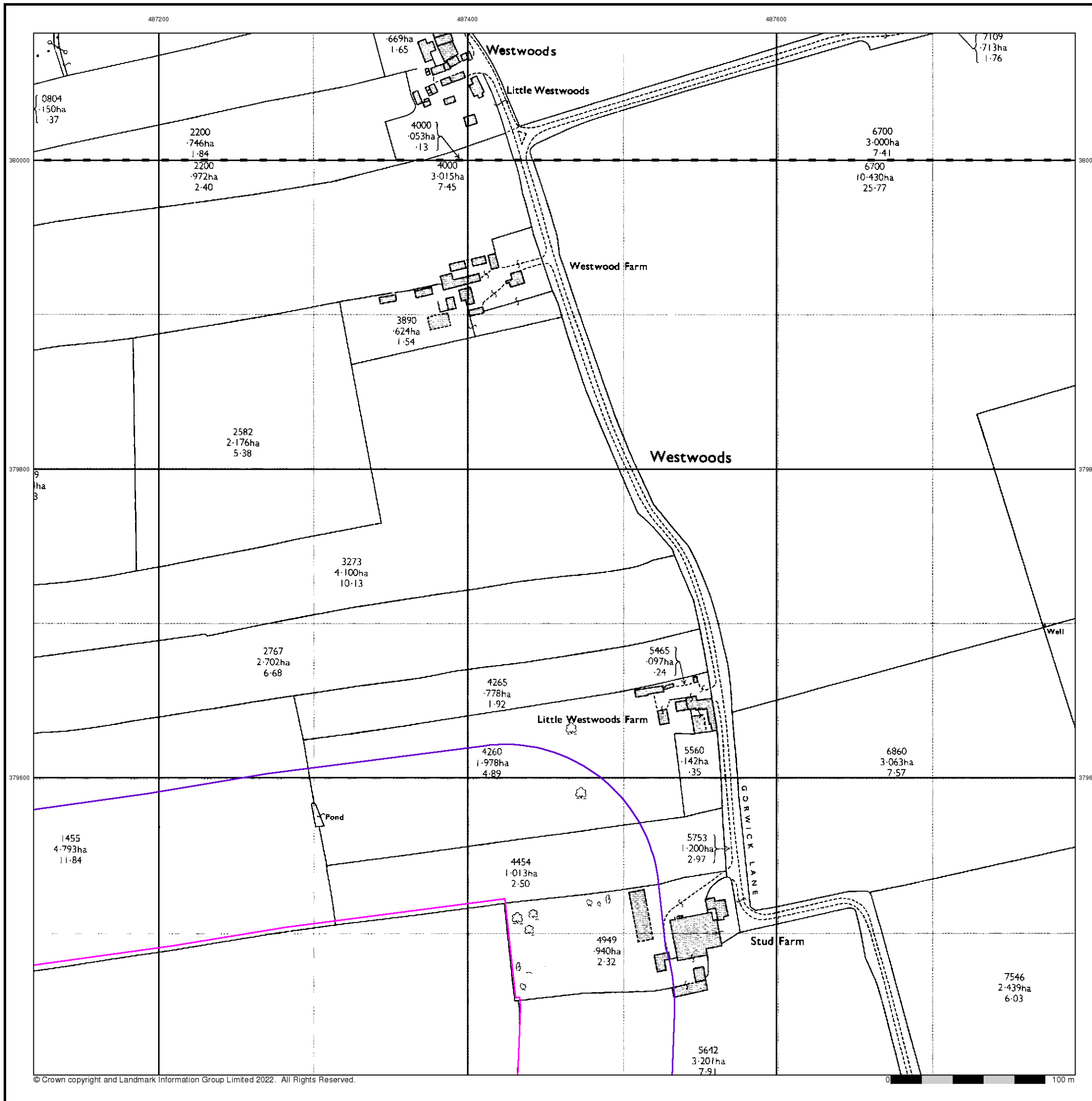

Large-Scale National Grid Data

Published 1994

Source map scale - 1:2,500

'Large Scale National Grid Data' superseded SIM cards (Ordnance Survey's 'Survey of Information on Microfilm') in 1992, and continued to be produced until 1999. These maps were the fore-runners of digital mapping and so provide detailed information on houses and roads, but tend to show less topographic features such as vegetation. These maps were produced at both 1:2,500 and 1:1,250 scales.

Map Name(s) and Date(s)

SK8780	1994	1:2,500
SK8779	1994	1:2,500

Historical Map - Segment F4

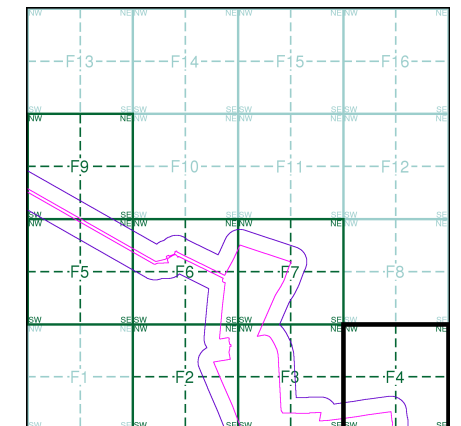

Order Details

Order Number: 298001007_1_1
 Customer Ref: 21-1098.04
 National Grid Reference: 486340, 380210
 Slice: F
 Site Area (Ha): 471.82
 Search Buffer (m): 100

Site Details

West Barton 1

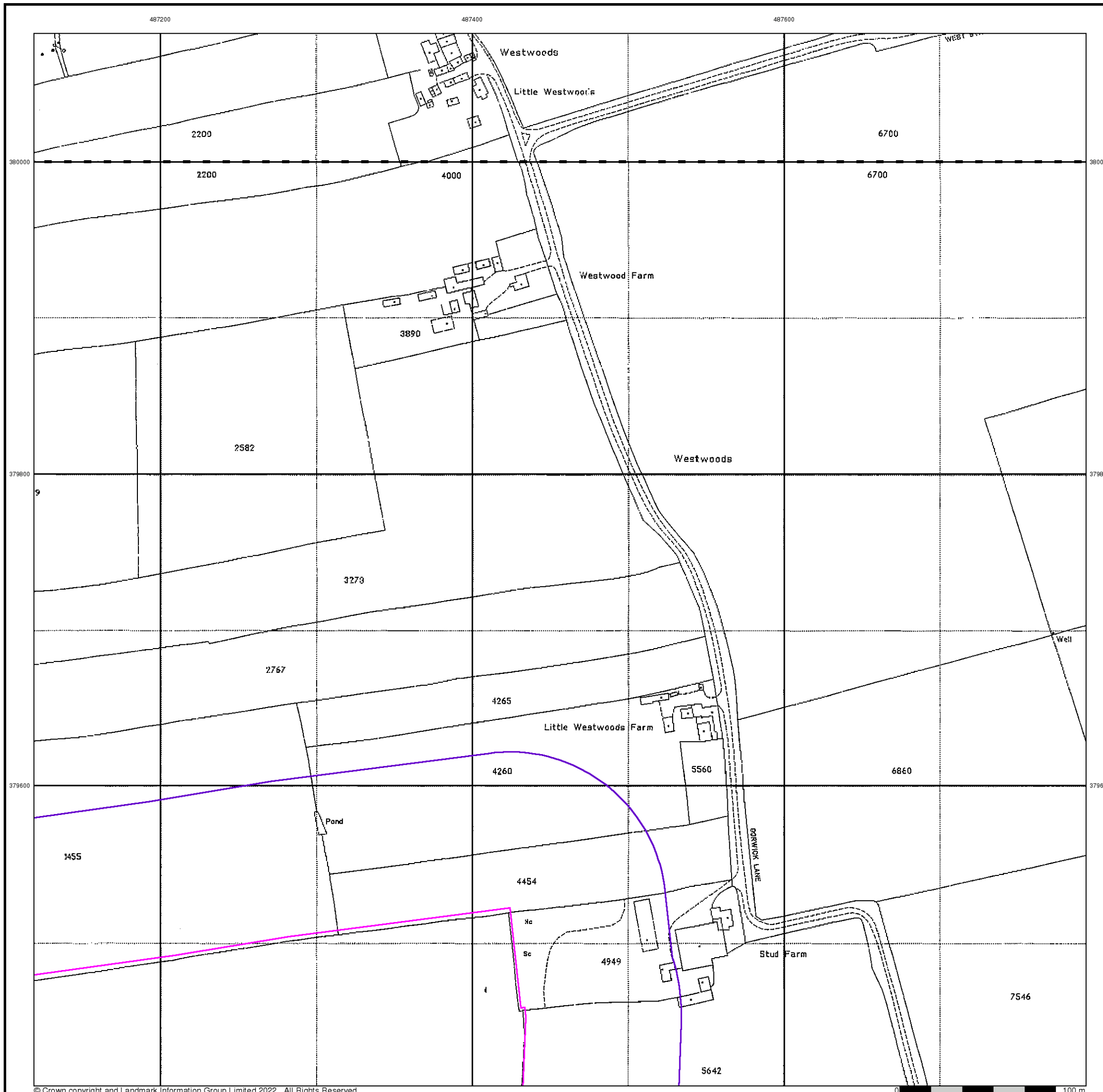

Historical Mapping Legends

Ordnance Survey County Series and Ordnance Survey Plan 1:2,500

Quarry **Gravel Pit** **Sand Pit**
Clay Pit **Shingle** **Refuse Heap**
Sloping Masonry **Flat Rock**
Marsh **Reeds** **Osiers**
Rough Pasture **Furze** **Wood**
Mixed Wood **Brushwood** **Orchard**
Fir **Ford** **Stepping Stones**
Ferry **Waterfall** **Lock**
Trig. Station **Altitude at Trig. Station**
B.M. 325.9 **Bench Mark** **Surface Level**
Arrow denotes flow of water **Antiquities (site of)**
Cutting **Embankment**
Railway crossing Road **Level Crossing** **Road crossing Railway**
Railway crossing River or Canal **Road over single stream** **Road over River or Canal**
County Boundary (Geographical)
County & Civil Parish Boundary
Administrative County & Civil Parish Boundary
County Borough Boundary (England)
County Burgh Boundary (Scotland)
Boundary Post or Stone **Police Call Box**
B.R. Bridle Road **P Pump**
E.P. Electricity Pylon **S.P. Signal Post**
F.B. Foot Bridge **Sl. Sluice**
F.P. Foot Path **Sp. Spring**
G.P. Guide Post or Board **T.C.B. Telephone Call Box**
M.S. Mile Stone **Tr. Trough**
M.P. M.R. Mooring Post or Ring **W Well**

Ordnance Survey Plan, Additional SIMs and Supply of Unpublished Survey Information 1:2,500 and 1:1,250

Inactive Quarry, Chalk Pit or Clay Pit **Active Quarry, Chalk Pit or Clay Pit**
Rock **Boulders**
Cliff **Slopes** **Top**
Roofed Building **Glazed Roof Building**
Sloping Masonry **Archway**
Non-Coniferous Tree (surveyed) **Coniferous Tree (surveyed)**
Non-Coniferous Trees (not surveyed) **Coniferous Trees (not surveyed)**
Orchard Tree **Scrub** **Bracken**
Coppice, Osier **Reeds** **Marsh, Saltings**
Rough Grassland **Heath** **Culvert**
Direction of water flow **Bench Mark** **Antiquity (site of)**
Cave Entrance **Triangulation Station** **Electricity Pylon**
Electricity Transmission Line
County Boundary (Geographical)
County & Civil Parish Boundary
Civil Parish Boundary
Admin. County or County Bor. Boundary
London Borough Boundary
Symbol marking point where boundary mereing changes
BH Beer House **P Pillar, Pole or Post**
BP, BS Boundary Post or Stone **PO Post Office**
Cn, C Capstan, Crane **PC Public Convenience**
Chy Chimney **PH Public House**
D Fn Drinking Fountain **Pp Pump**
EI P Electricity Pillar or Post **SB, S Br Signal Box or Bridge**
FAP Fire Alarm Pillar **SP, SL Signal Post or Light**
FB Foot Bridge **Spr Spring**
GP Guide Post **Tk Tank or Track**
H Hydrant or Hydraulic **TCB Telephone Call Box**
LC Level Crossing **TCP Telephone Call Post**
MH Manhole **Tr Trough**
MP Mile Post or Mooring Post **Wr Pt, Wr T Water Point, Water Tap**
MS Mile Stone **W Well**
NTL Normal Tidal Limit **Wd Pp Wind Pump**

Large-Scale National Grid Data 1:2,500 and 1:1,250

Cliff **Slopes** **Top**
Rock **Rock (scattered)**
Boulders **Boulders (scattered)**
Positioned Boulder **Scree**
Non-Coniferous Tree (surveyed) **Coniferous Tree (surveyed)**
Non-Coniferous Trees (not surveyed) **Coniferous Trees (not surveyed)**
Orchard Tree **Scrub** **Bracken**
Coppice, Osier **Reeds** **Marsh, Saltings**
Rough Grassland **Heath** **Culvert**
Direction of water flow **Triangulation Station** **Antiquity (site of)**
Electricity Transmission Line **Electricity Pylon**
B.M. 231.60m Bench Mark **Buildings with Building Seed**
Roofed Building **Glazed Roof Building**
Civil parish/community boundary
District boundary
County boundary
Boundary post/stone
Boundary mereing symbol (note: these always appear in opposed pairs or groups of three)
Bks Barracks **P Pillar, Pole or Post**
Bty Battery **PO Post Office**
Cemy Cemetery **PC Public Convenience**
Chy Chimney **Pp Pump**
Cis Cistern **Ppg Sta Pumping Station**
Dismtd Rly Dismantled Railway **PW Place of Worship**
EI Gen Sta Electricity Generating Station **Sewage Ppg Sta Sewage Pumping Station**
EI P Electricity Pole, Pillar **SB, S Br Signal Box or Bridge**
EI Sub Sta Electricity Sub Station **SP, SL Signal Post or Light**
FB Filter Bed **Spr Spring**
Fn / D Fn Fountain / Drinking Ftn. **Tk Tank or Track**
Gas Gov Gas Valve Compound **Tr Trough**
GVC Gas Governor **Wd Pp Wind Pump**
GP Guide Post **Wr Pt, Wr T Water Point, Water Tap**
MH Manhole **Wks Works (building or area)**
MP, MS Mile Post or Mile Stone **W Well**

Historical Mapping & Photography included:

Mapping Type	Scale	Date	Pg
Lincolnshire	1:2,500	1886	2
Lincolnshire	1:2,500	1906	3
Lincolnshire	1:2,500	1920	4
Ordnance Survey Plan	1:2,500	1974	5
Large-Scale National Grid Data	1:2,500	1994	6

Historical Map - Segment F5

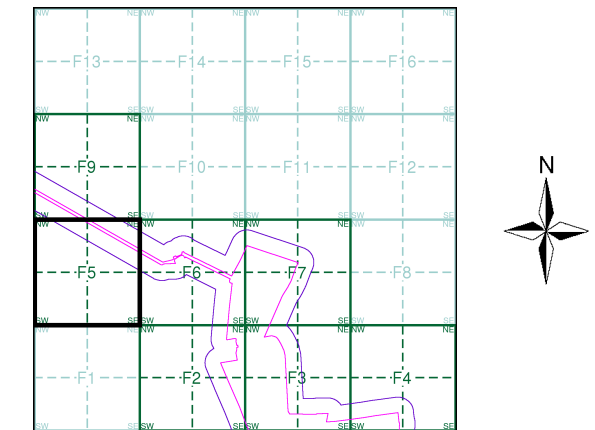

Order Details

Order Number: 298001007_1_1
 Customer Ref: 21-1098.04
 National Grid Reference: 486340, 380210
 Slice: F
 Site Area (Ha): 471.82
 Search Buffer (m): 100

Site Details

West Barton 1

Lincolnshire

Published 1886

Source map scale - 1:2,500

The historical maps shown were reproduced from maps predominantly held at the scale adopted for England, Wales and Scotland in the 1840's. In 1854 the 1:2,500 scale was adopted for mapping urban areas and by 1896 it covered the whole of what were considered to be the cultivated parts of Great Britain. The published date given below is often some years later than the surveyed date. Before 1938, all OS maps were based on the Cassini Projection, with independent surveys of a single county or group of counties, giving rise to significant inaccuracies in outlying areas.

Map Name(s) and Date(s)

051_14	1886	1:2,500
060_02	1886	1:2,500

Historical Map - Segment F5

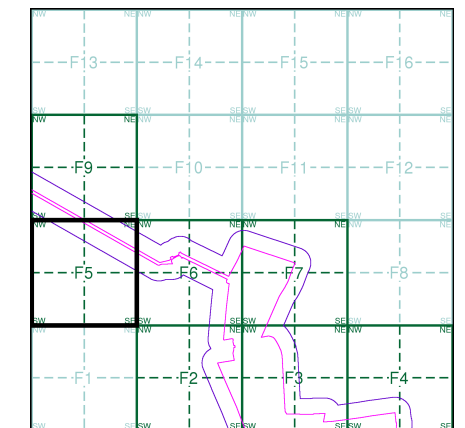

Order Details

Order Number: 298001007_1_1
 Customer Ref: 21-1098.04
 National Grid Reference: 486340, 380210
 Slice: F
 Site Area (Ha): 471.82
 Search Buffer (m): 100

Site Details

West Barton 1

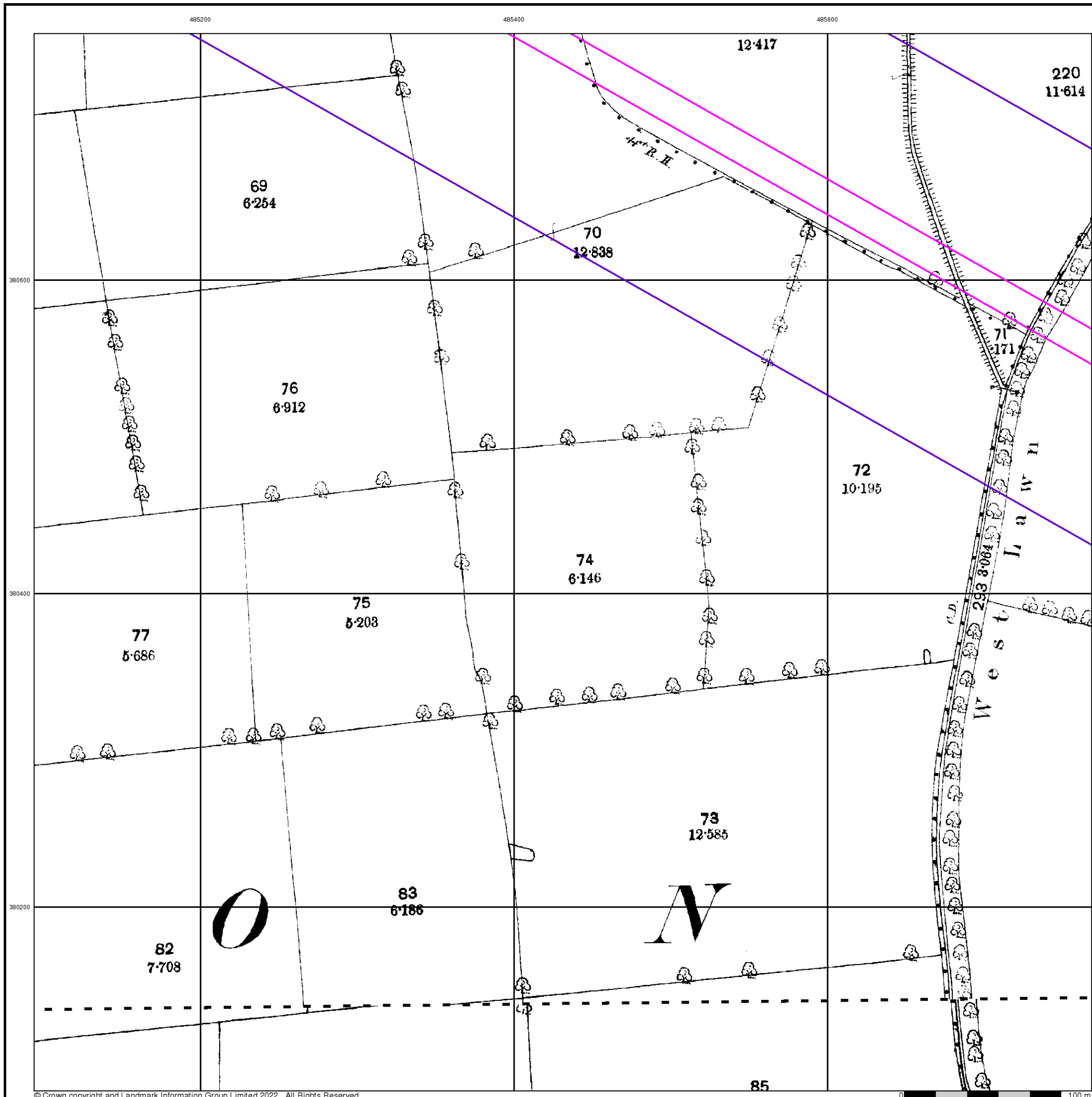

Lincolnshire

Published 1906

Source map scale - 1:2,500

The historical maps shown were reproduced from maps predominantly held at the scale adopted for England, Wales and Scotland in the 1840's. In 1854 the 1:2,500 scale was adopted for mapping urban areas and by 1896 it covered the whole of what were considered to be the cultivated parts of Great Britain. The published date given below is often some years later than the surveyed date. Before 1938, all OS maps were based on the Cassini Projection, with independent surveys of a single county or group of counties, giving rise to significant inaccuracies in outlying areas.

Map Name(s) and Date(s)

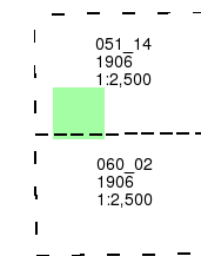

Historical Map - Segment F5

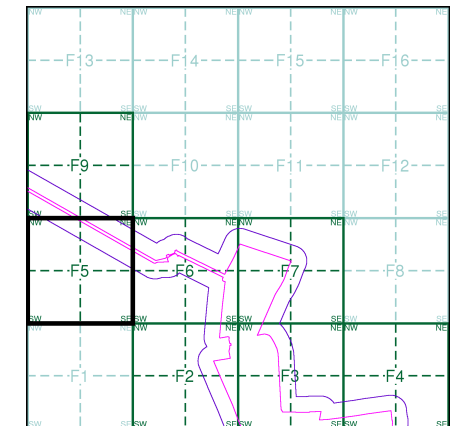

Order Details

Order Number: 298001007_1_1
 Customer Ref: 21-1098.04
 National Grid Reference: 486340, 380210
 Slice: F
 Site Area (Ha): 471.82
 Search Buffer (m): 100

Site Details

West Barton 1

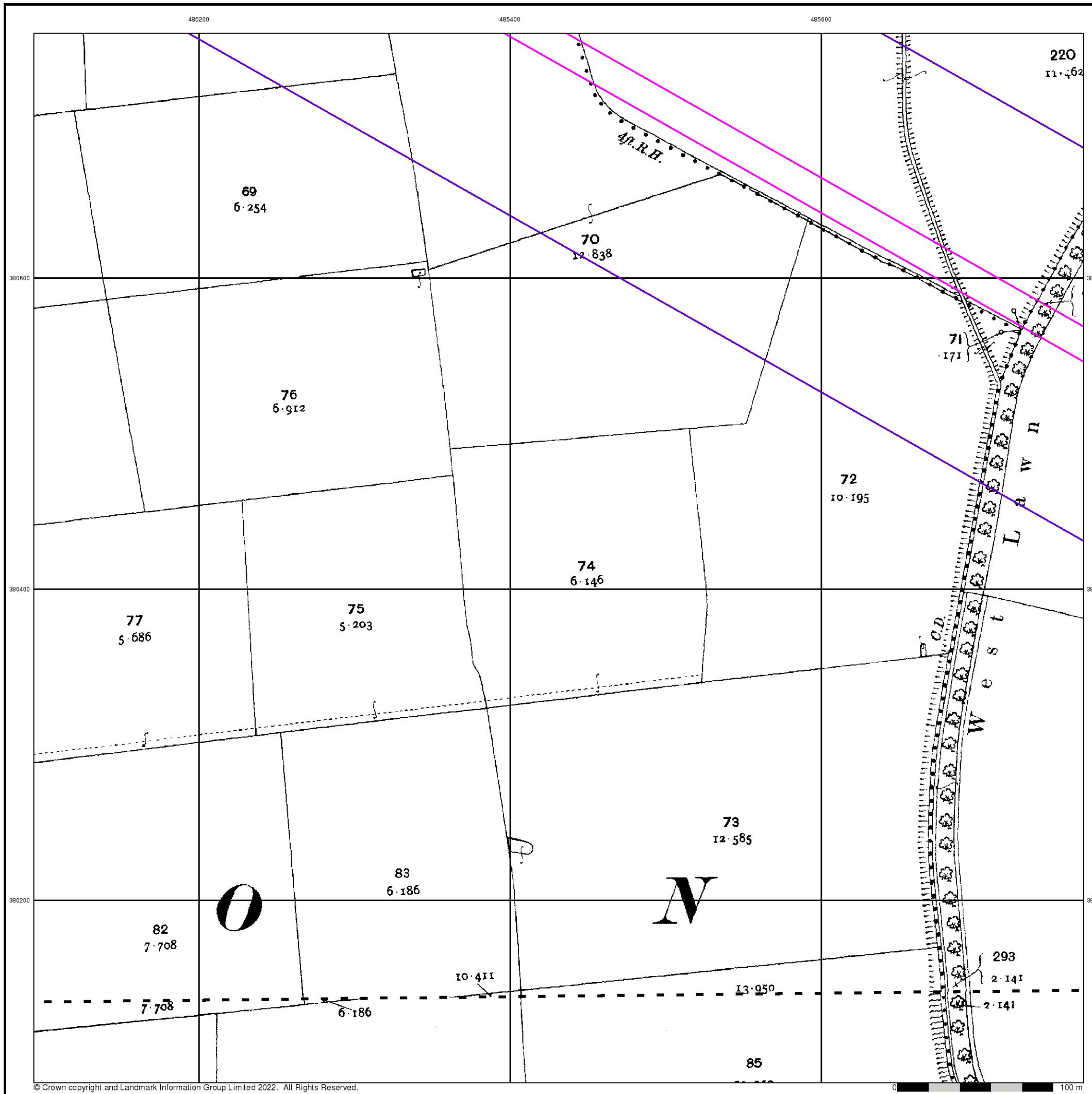

Lincolnshire

Published 1920

Source map scale - 1:2,500

The historical maps shown were reproduced from maps predominantly held at the scale adopted for England, Wales and Scotland in the 1840's. In 1854 the 1:2,500 scale was adopted for mapping urban areas and by 1896 it covered the whole of what were considered to be the cultivated parts of Great Britain. The published date given below is often some years later than the surveyed date. Before 1938, all OS maps were based on the Cassini Projection, with independent surveys of a single county or group of counties, giving rise to significant inaccuracies in outlying areas.

Map Name(s) and Date(s)

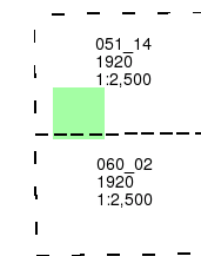

Historical Map - Segment F5

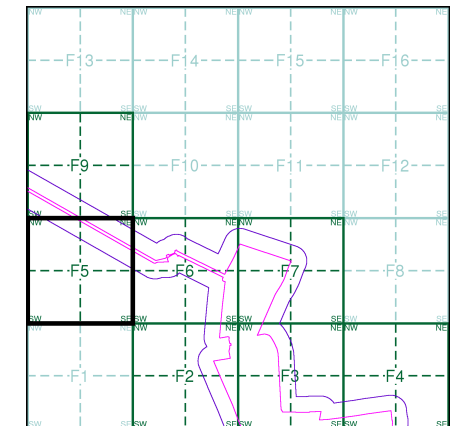

Order Details

Order Number: 298001007_1_1
 Customer Ref: 21-1098.04
 National Grid Reference: 486340, 380210
 Slice: F
 Site Area (Ha): 471.82
 Search Buffer (m): 100

Site Details

West Barton 1

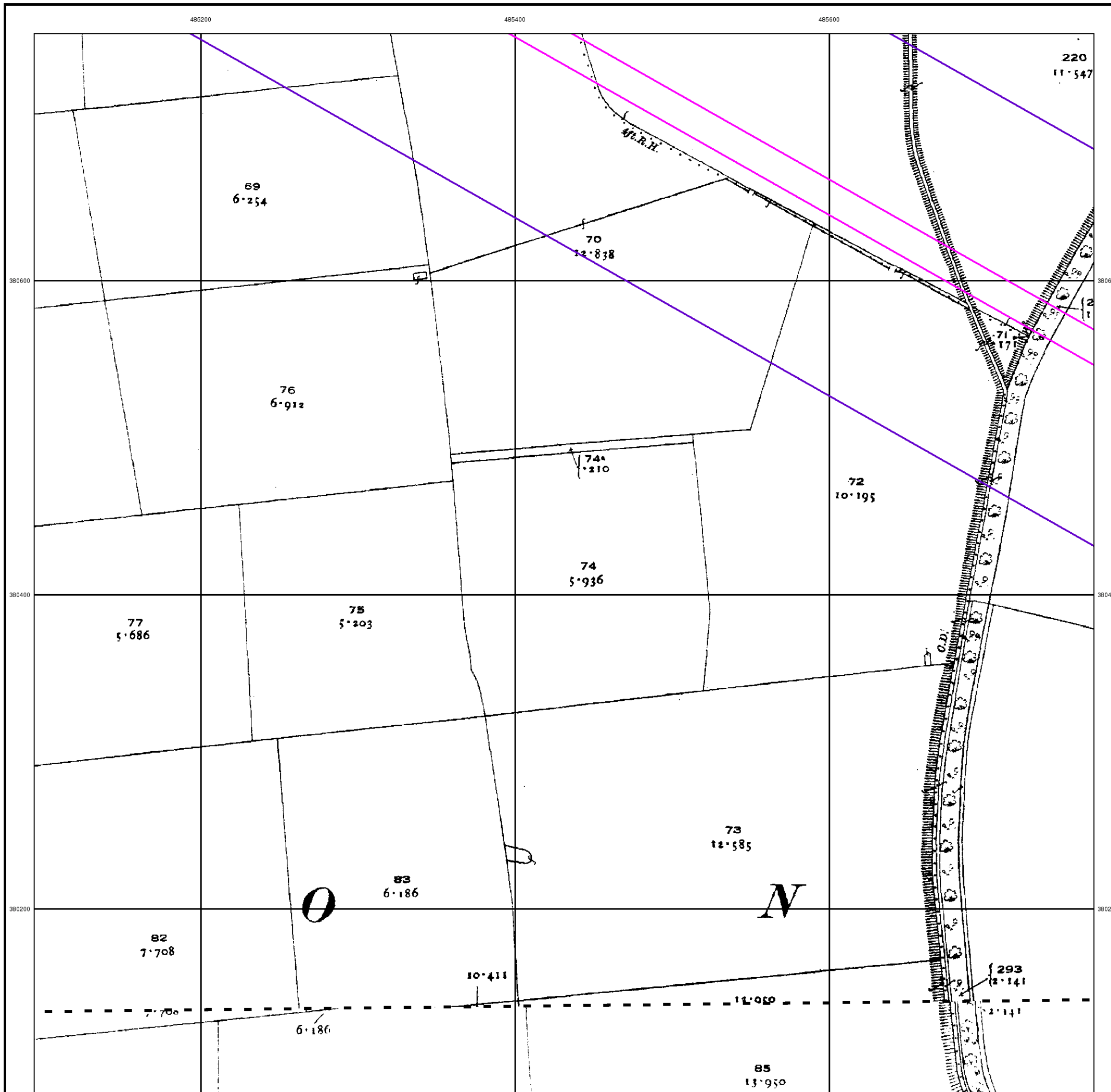

Ordnance Survey Plan

Published 1974

Source map scale - 1:2,500

The historical maps shown were reproduced from maps predominantly held at the scale adopted for England, Wales and Scotland in the 1840's. In 1854 the 1:2,500 scale was adopted for mapping urban areas and by 1896 it covered the whole of what were considered to be the cultivated parts of Great Britain. The published date given below is often some years later than the surveyed date. Before 1938, all OS maps were based on the Cassini Projection, with independent surveys of a single county or group of counties, giving rise to significant inaccuracies in outlying areas.

Map Name(s) and Date(s)

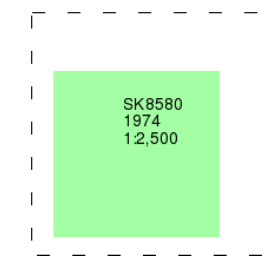

Historical Map - Segment F5

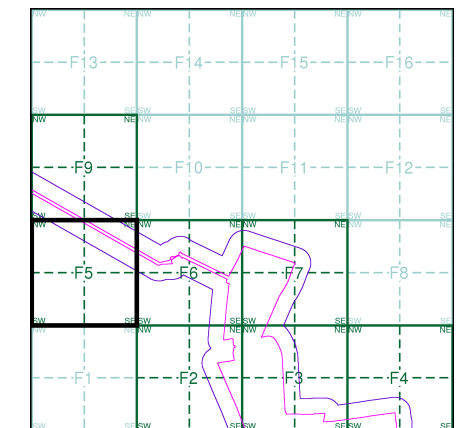

Order Details

Order Number: 298001007_1_1
 Customer Ref: 21-1098.04
 National Grid Reference: 486340, 380210
 Slice: F
 Site Area (Ha): 471.82
 Search Buffer (m): 100

Site Details

West Barton 1

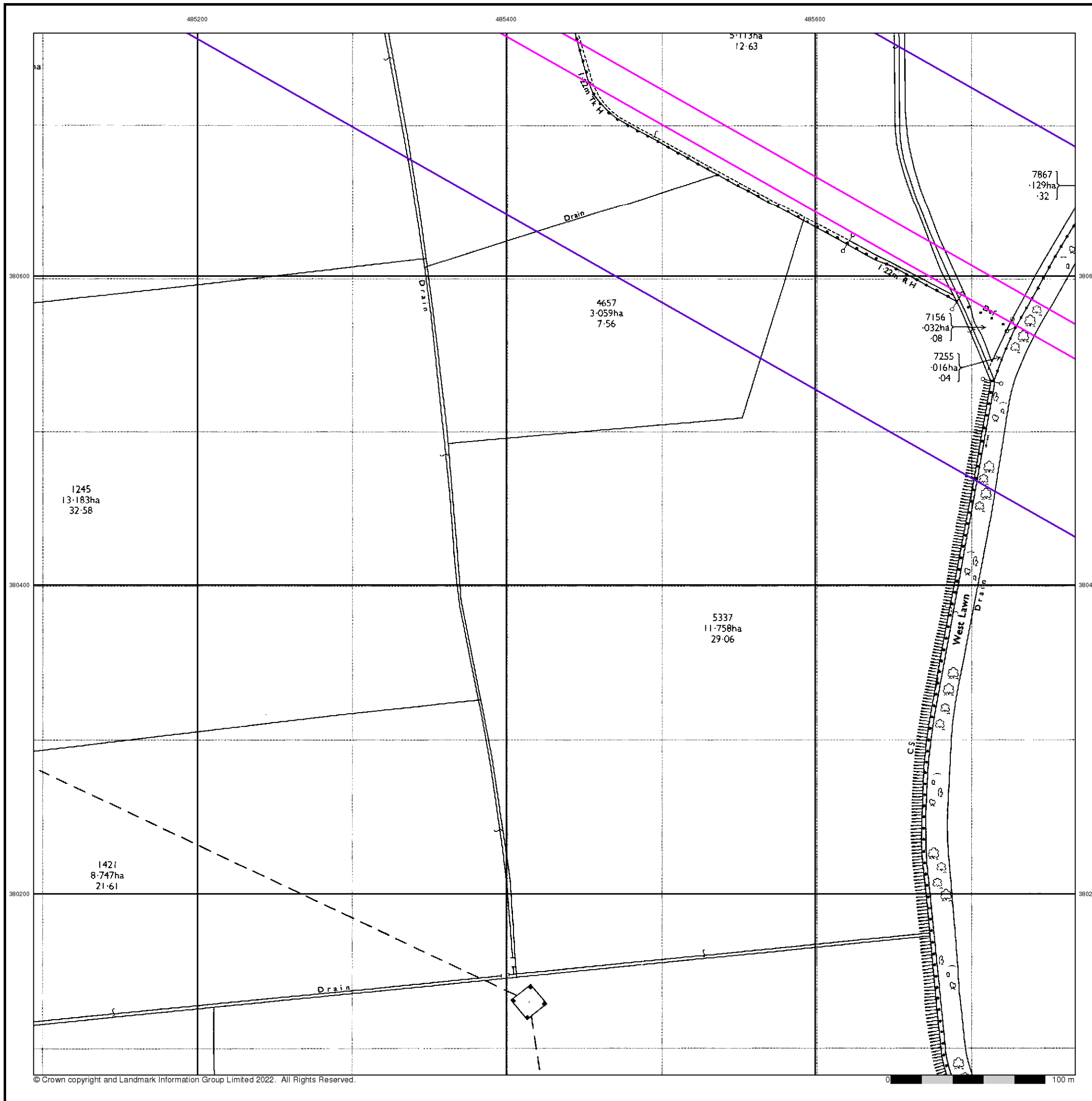

Large-Scale National Grid Data

Published 1994

Source map scale - 1:2,500

'Large Scale National Grid Data' superseded SIM cards (Ordnance Survey's 'Survey of Information on Microfilm') in 1992, and continued to be produced until 1999. These maps were the fore-runners of digital mapping and so provide detailed information on houses and roads, but tend to show less topographic features such as vegetation. These maps were produced at both 1:2,500 and 1:1,250 scales.

Map Name(s) and Date(s)

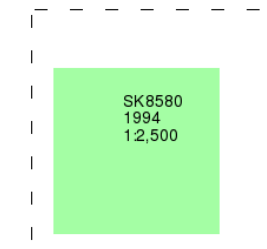

Historical Map - Segment F5

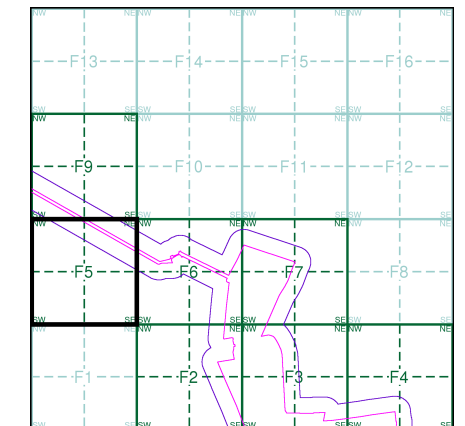

Order Details

Order Number: 298001007_1_1
 Customer Ref: 21-1098.04
 National Grid Reference: 486340, 380210
 Slice: F
 Site Area (Ha): 471.82
 Search Buffer (m): 100

Site Details

West Barton 1

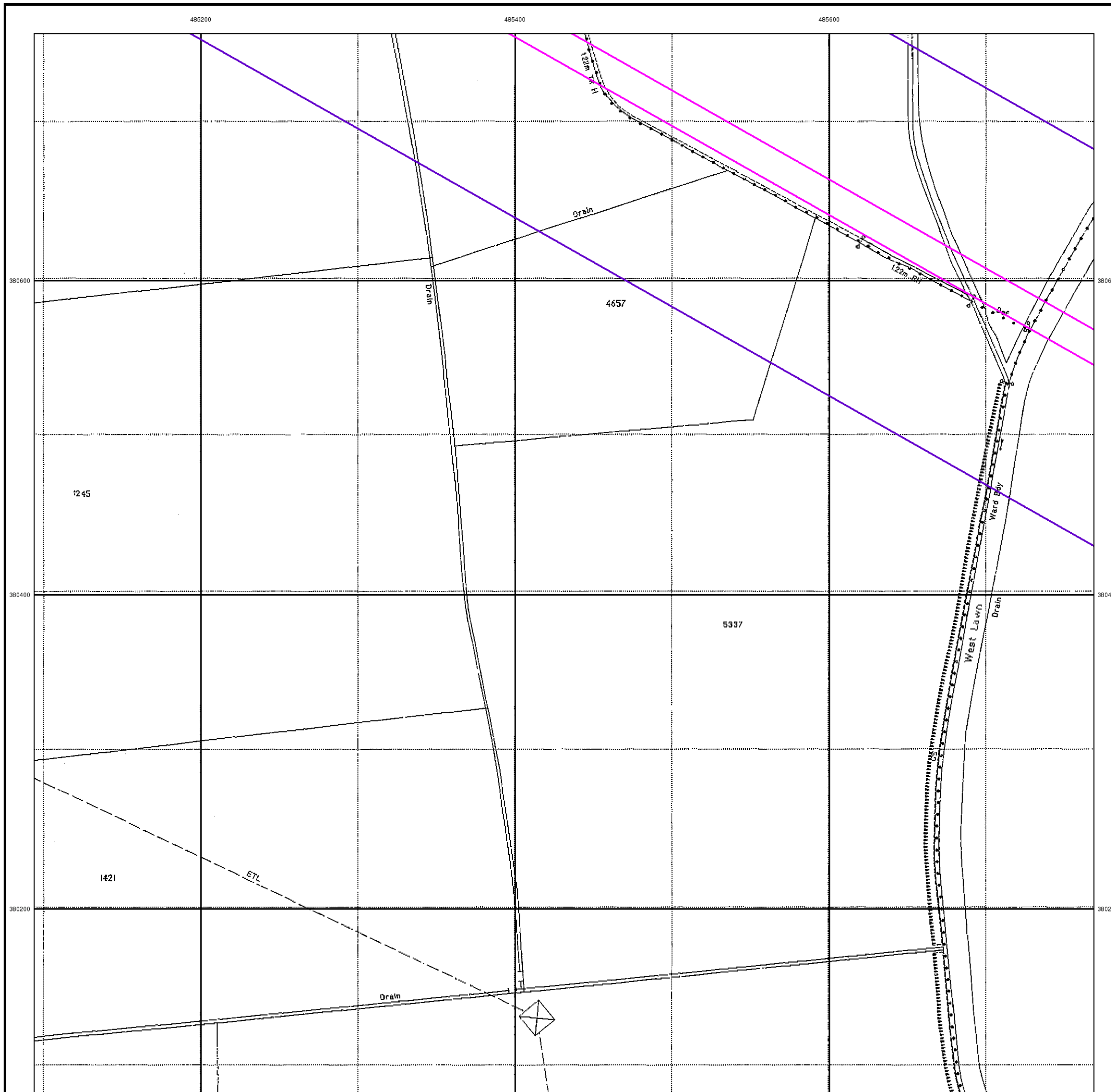

Historical Mapping Legends

Ordnance Survey County Series and Ordnance Survey Plan 1:2,500

Quarry **Gravel Pit** **Sand Pit**
Clay Pit **Shingle** **Refuse Heap**
Sloping Masonry **Flat Rock**
Marsh **Reeds** **Osiers**
Rough Pasture **Furze** **Wood**
Mixed Wood **Brushwood** **Orchard**
Fir **Ford** **Stepping Stones**
Ferry **Waterfall** **Lock**
Trig. Station **Altitude at Trig. Station**
B.M. 325.9 **Bench Mark** **Surface Level**
Arrow denotes flow of water **Antiquities (site of)**
Cutting **Embankment**
Railway crossing Road **Level Crossing** **Road crossing Railway**
Railway crossing River or Canal **Road over single stream** **Road over River or Canal**
County Boundary (Geographical)
County & Civil Parish Boundary
Administrative County & Civil Parish Boundary
County Borough Boundary (England)
County Burgh Boundary (Scotland)
Boundary Post or Stone **Police Call Box**
B.R. Bridle Road **Pump**
E.P. Electricity Pylon **S.P. Signal Post**
F.B. Foot Bridge **Sl. Sluice**
F.P. Foot Path **Sp. Spring**
G.P. Guide Post or Board **T.C.B. Telephone Call Box**
M.S. Mile Stone **Tr. Trough**
M.P. M.R. Mooring Post or Ring **W. Well**

Ordnance Survey Plan, Additional SIMs and Supply of Unpublished Survey Information 1:2,500 and 1:1,250

Inactive Quarry, Chalk Pit or Clay Pit **Active Quarry, Chalk Pit or Clay Pit**
Rock **Boulders**
Cliff **Slopes** **Top**
Roofed Building **Glazed Roof Building**
Sloping Masonry **Archway**
Non-Coniferous Tree (surveyed) **Coniferous Tree (surveyed)**
Non-Coniferous Trees (not surveyed) **Coniferous Trees (not surveyed)**
Orchard Tree **Scrub** **Bracken**
Coppice, Osier **Reeds** **Marsh, Saltings**
Rough Grassland **Heath** **Culvert**
Direction of water flow **Bench Mark** **Antiquity (site of)**
Cave Entrance **Triangulation Station** **Electricity Pylon**
Electricity Transmission Line
County Boundary (Geographical)
County & Civil Parish Boundary
Civil Parish Boundary
Admin. County or County Bor. Boundary
London Borough Boundary
Symbol marking point where boundary mereing changes
Beer House **Pillar, Pole or Post**
Boundary Post or Stone **Post Office**
Capstan, Crane **Public Convenience**
Chimney **Public House**
Drinking Fountain **Pump**
Electricity Pillar or Post **Signal Box or Bridge**
Fire Alarm Pillar **Signal Post or Light**
Foot Bridge **Spring**
Guide Post **Tank or Track**
Hydrant or Hydraulic **Telephone Call Box**
Level Crossing **Telephone Call Post**
Manhole **Trough**
Mile Post or Mooring Post **Water Point, Water Tap**
Mile Stone **Well**
Normal Tidal Limit **Wind Pump**

Large-Scale National Grid Data 1:2,500 and 1:1,250

Cliff **Slopes** **Top**
Rock **Rock (scattered)**
Boulders **Boulders (scattered)**
Positioned Boulder **Scree**
Non-Coniferous Tree (surveyed) **Coniferous Tree (surveyed)**
Non-Coniferous Trees (not surveyed) **Coniferous Trees (not surveyed)**
Orchard Tree **Scrub** **Bracken**
Coppice, Osier **Reeds** **Marsh, Saltings**
Rough Grassland **Heath** **Culvert**
Direction of water flow **Triangulation Station** **Antiquity (site of)**
Electricity Transmission Line **Electricity Pylon**
Bench Mark **Buildings with Building Seed**
Roofed Building **Glazed Roof Building**
Civil parish/community boundary
District boundary
County boundary
Boundary post/stone
Boundary mereing symbol (note: these always appear in opposed pairs or groups of three)
Barracks **Pillar, Pole or Post**
Battery **Post Office**
Cemetery **Public Convenience**
Chimney **Pump**
Cistern **Pumping Station**
Dismtd Rly **Place of Worship**
Electricity Generating Station **Sewage Ppg Sta** **Sewage Pumping Station**
Electricity Pole, Pillar **Signal Box or Bridge**
Electricity Sub Station **Signal Post or Light**
Filter Bed **Spring**
Fountain / Drinking Ftn. **Tank or Track**
Gas Valve Compound **Trough**
Gas Governor **Wind Pump**
Guide Post **Water Point, Water Tap**
Manhole **Works (building or area)**
Mile Post or Mile Stone **Well**

Historical Mapping & Photography included:

Mapping Type	Scale	Date	Pg
Lincolnshire	1:2,500	1886	2
Lincolnshire	1:2,500	1906	3
Lincolnshire	1:2,500	1920	4
Ordnance Survey Plan	1:2,500	1974 - 1975	5
Large-Scale National Grid Data	1:2,500	1994	6

Historical Map - Segment F6

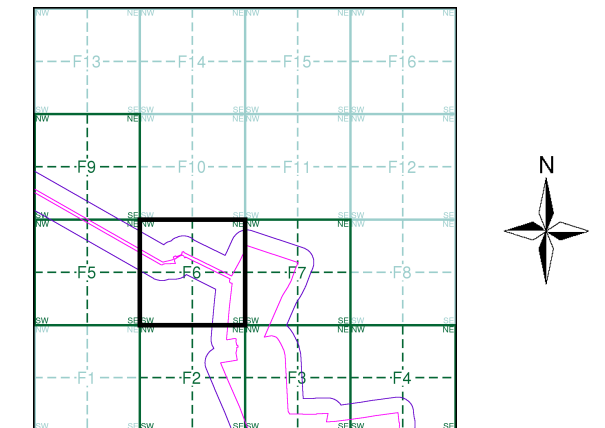

Order Details

Order Number: 298001007_1_1
 Customer Ref: 21-1098.04
 National Grid Reference: 486340, 380210
 Slice: F
 Site Area (Ha): 471.82
 Search Buffer (m): 100

Site Details

West Barton 1

Lincolnshire
Published 1886

Source map scale - 1:2,500

The historical maps shown were reproduced from maps predominantly held at the scale adopted for England, Wales and Scotland in the 1840's. In 1854 the 1:2,500 scale was adopted for mapping urban areas and by 1896 it covered the whole of what were considered to be the cultivated parts of Great Britain. The published date given below is often some years later than the surveyed date. Before 1938, all OS maps were based on the Cassini Projection, with independent surveys of a single county or group of counties, giving rise to significant inaccuracies in outlying areas.

Map Name(s) and Date(s)

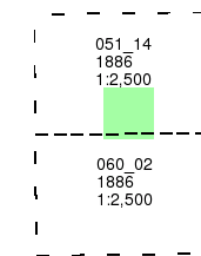

Historical Map - Segment F6

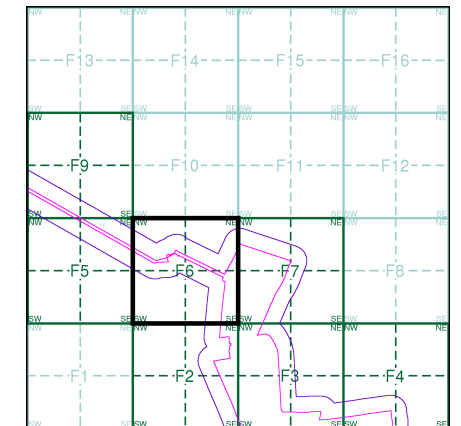

Order Details

Order Number: 298001007_1_1
 Customer Ref: 21-1098.04
 National Grid Reference: 486340, 380210
 Slice: F
 Site Area (Ha): 471.82
 Search Buffer (m): 100

Site Details

West Barton 1

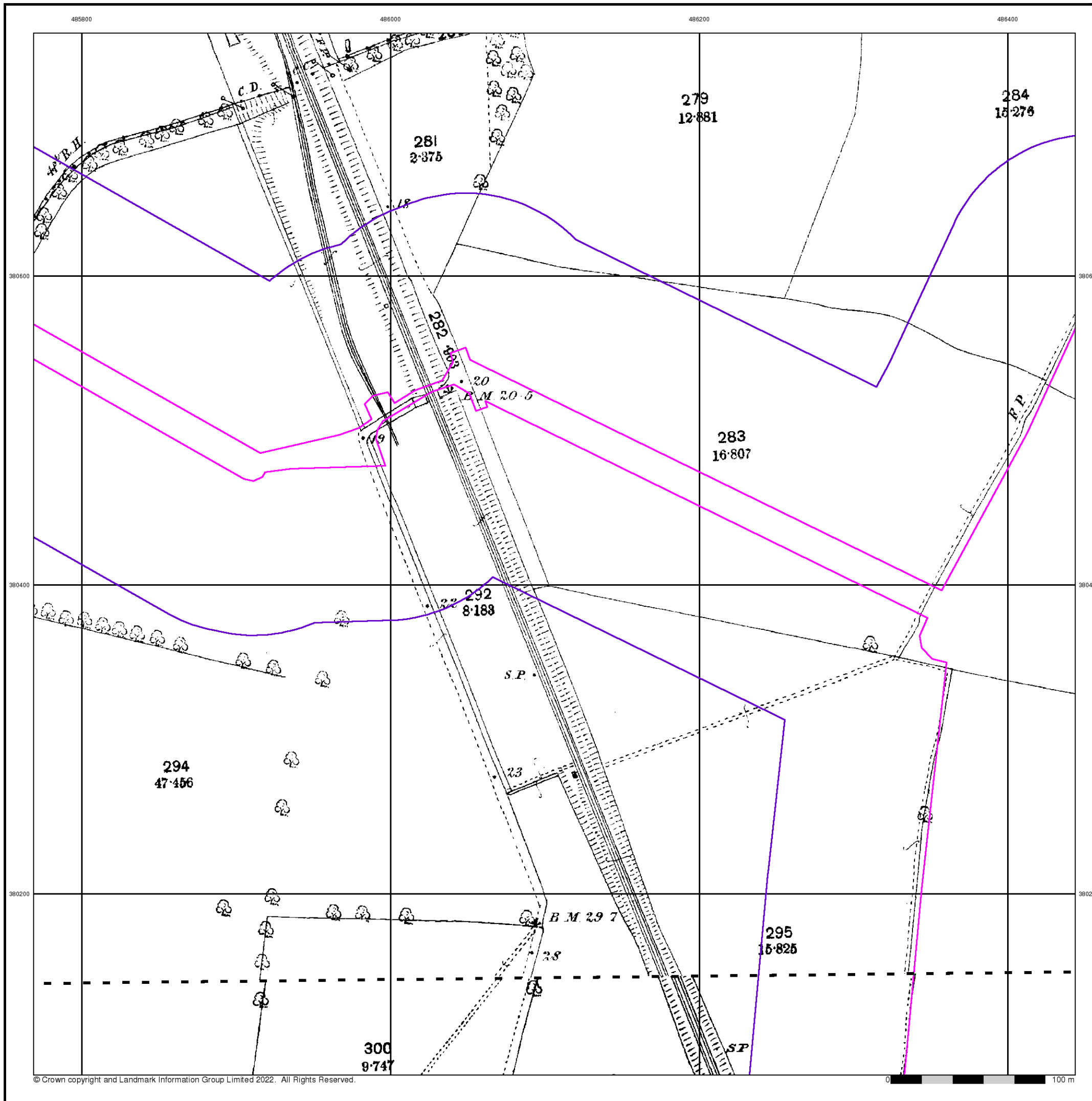

Lincolnshire
Published 1906

Source map scale - 1:2,500

The historical maps shown were reproduced from maps predominantly held at the scale adopted for England, Wales and Scotland in the 1840's. In 1854 the 1:2,500 scale was adopted for mapping urban areas and by 1896 it covered the whole of what were considered to be the cultivated parts of Great Britain. The published date given below is often some years later than the surveyed date. Before 1938, all OS maps were based on the Cassini Projection, with independent surveys of a single county or group of counties, giving rise to significant inaccuracies in outlying areas.

Map Name(s) and Date(s)

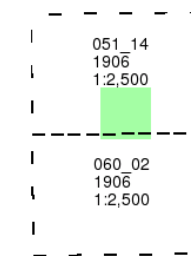

Historical Map - Segment F6

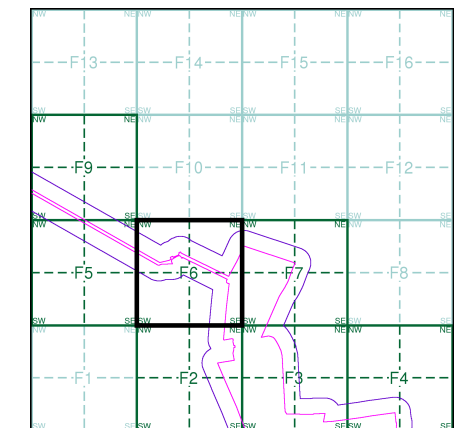

Order Details

Order Number: 298001007_1_1
 Customer Ref: 21-1098.04
 National Grid Reference: 486340, 380210
 Slice: F
 Site Area (Ha): 471.82
 Search Buffer (m): 100

Site Details

West Barton 1

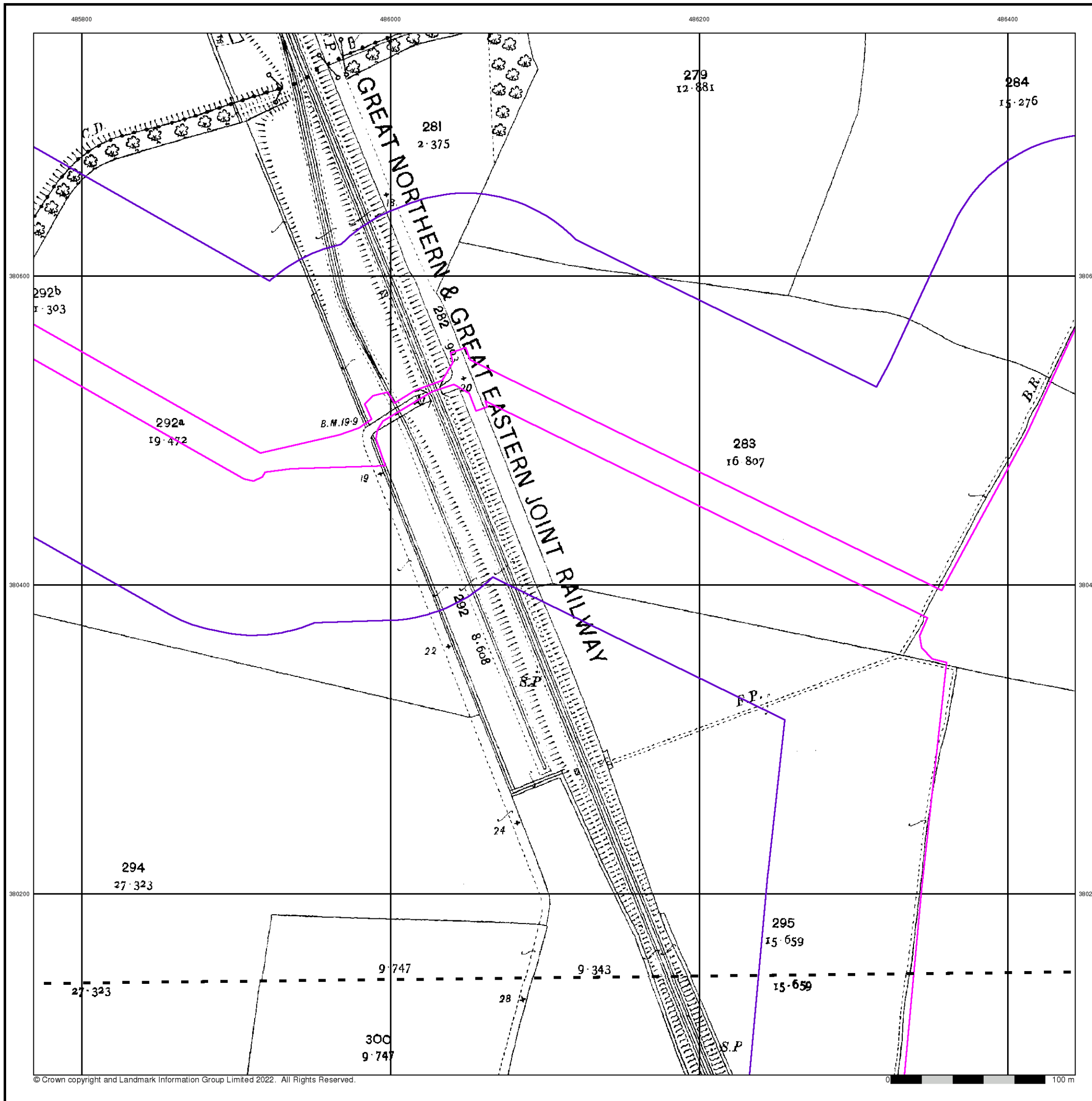

Lincolnshire

Published 1920

Source map scale - 1:2,500

The historical maps shown were reproduced from maps predominantly held at the scale adopted for England, Wales and Scotland in the 1840's. In 1854 the 1:2,500 scale was adopted for mapping urban areas and by 1896 it covered the whole of what were considered to be the cultivated parts of Great Britain. The published date given below is often some years later than the surveyed date. Before 1938, all OS maps were based on the Cassini Projection, with independent surveys of a single county or group of counties, giving rise to significant inaccuracies in outlying areas.

Map Name(s) and Date(s)

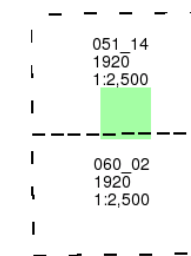

Historical Map - Segment F6

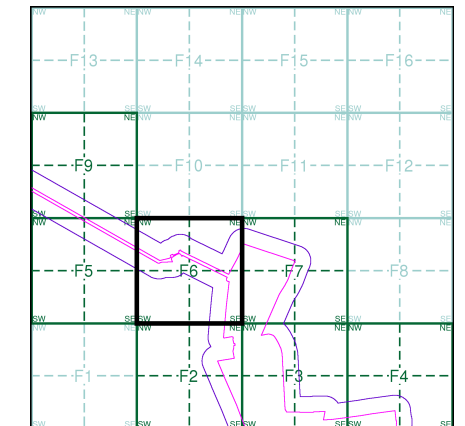

Order Details

Order Number: 298001007_1_1
 Customer Ref: 21-1098.04
 National Grid Reference: 486340, 380210
 Slice: F
 Site Area (Ha): 471.82
 Search Buffer (m): 100

Site Details

West Barton 1

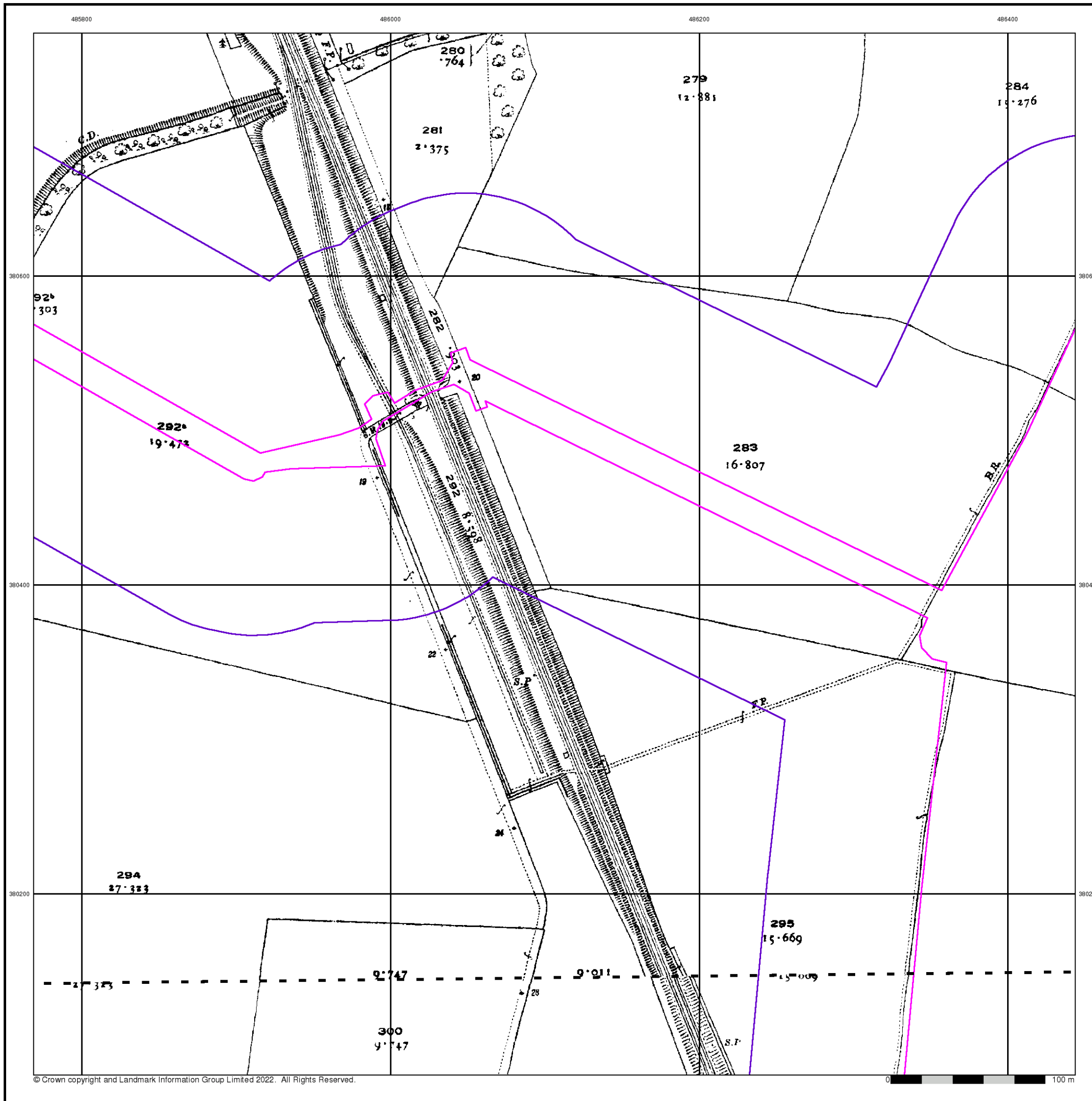

Ordnance Survey Plan
Published 1974 - 1975
Source map scale - 1:2,500

The historical maps shown were reproduced from maps predominantly held at the scale adopted for England, Wales and Scotland in the 1840's. In 1854 the 1:2,500 scale was adopted for mapping urban areas and by 1896 it covered the whole of what were considered to be the cultivated parts of Great Britain. The published date given below is often some years later than the surveyed date. Before 1938, all OS maps were based on the Cassini Projection, with independent surveys of a single county or group of counties, giving rise to significant inaccuracies in outlying areas.

Map Name(s) and Date(s)

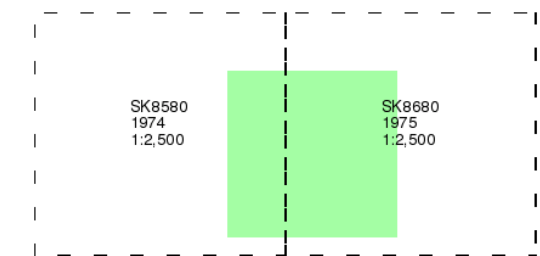

Historical Map - Segment F6

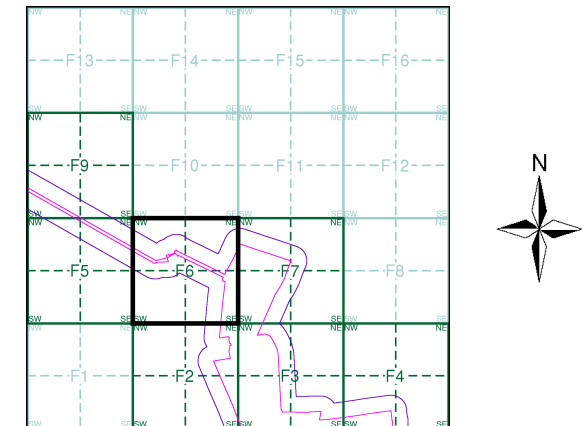

Order Details

Order Number: 298001007_1_1
 Customer Ref: 21-1098.04
 National Grid Reference: 486340, 380210
 Slice: F
 Site Area (Ha): 471.82
 Search Buffer (m): 100

Site Details

West Barton 1

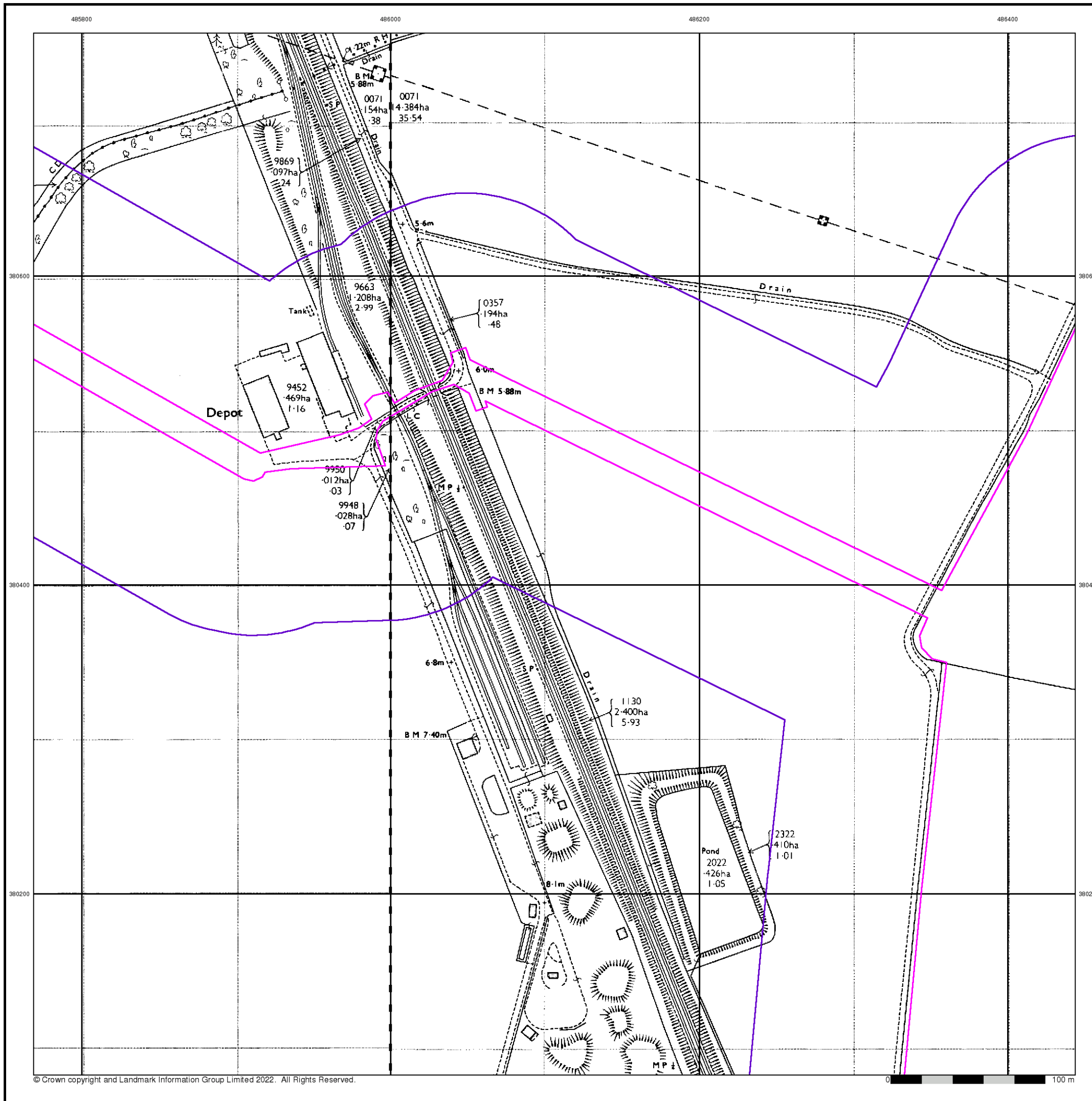

Large-Scale National Grid Data

Published 1994

Source map scale - 1:2,500

'Large Scale National Grid Data' superseded SIM cards (Ordnance Survey's 'Survey of Information on Microfilm') in 1992, and continued to be produced until 1999. These maps were the fore-runners of digital mapping and so provide detailed information on houses and roads, but tend to show less topographic features such as vegetation. These maps were produced at both 1:2,500 and 1:1,250 scales.

Map Name(s) and Date(s)

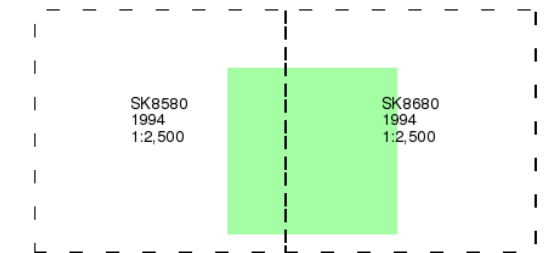

Historical Map - Segment F6

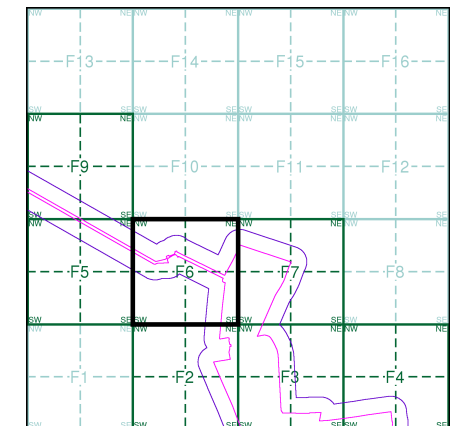

Order Details

Order Number: 298001007_1_1
 Customer Ref: 21-1098.04
 National Grid Reference: 486340, 380210
 Slice: F
 Site Area (Ha): 471.82
 Search Buffer (m): 100

Site Details

West Barton 1

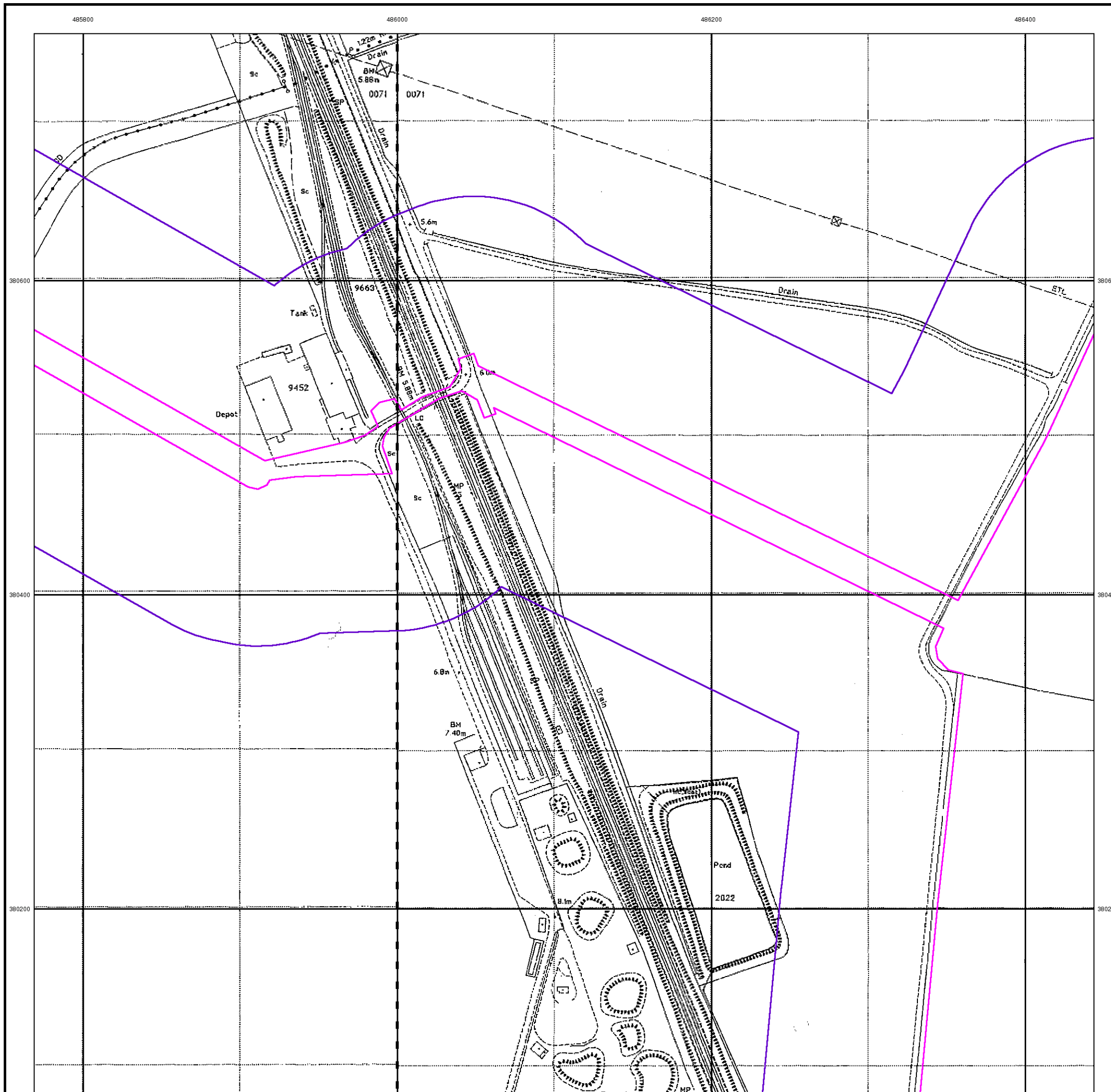

Lincolnshire

Published 1886

Source map scale - 1:2,500

The historical maps shown were reproduced from maps predominantly held at the scale adopted for England, Wales and Scotland in the 1840's. In 1854 the 1:2,500 scale was adopted for mapping urban areas and by 1896 it covered the whole of what were considered to be the cultivated parts of Great Britain. The published date given below is often some years later than the surveyed date. Before 1938, all OS maps were based on the Cassini Projection, with independent surveys of a single county or group of counties, giving rise to significant inaccuracies in outlying areas.

Map Name(s) and Date(s)

051_14	1886	1:2,500
060_02	1886	1:2,500

Historical Map - Segment F7

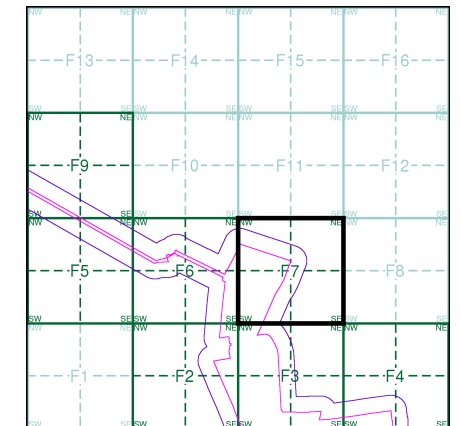

Order Details

Order Number: 298001007_1_1
 Customer Ref: 21-1098.04
 National Grid Reference: 486340, 380210
 Slice: F
 Site Area (Ha): 471.82
 Search Buffer (m): 100

Site Details

West Barton 1

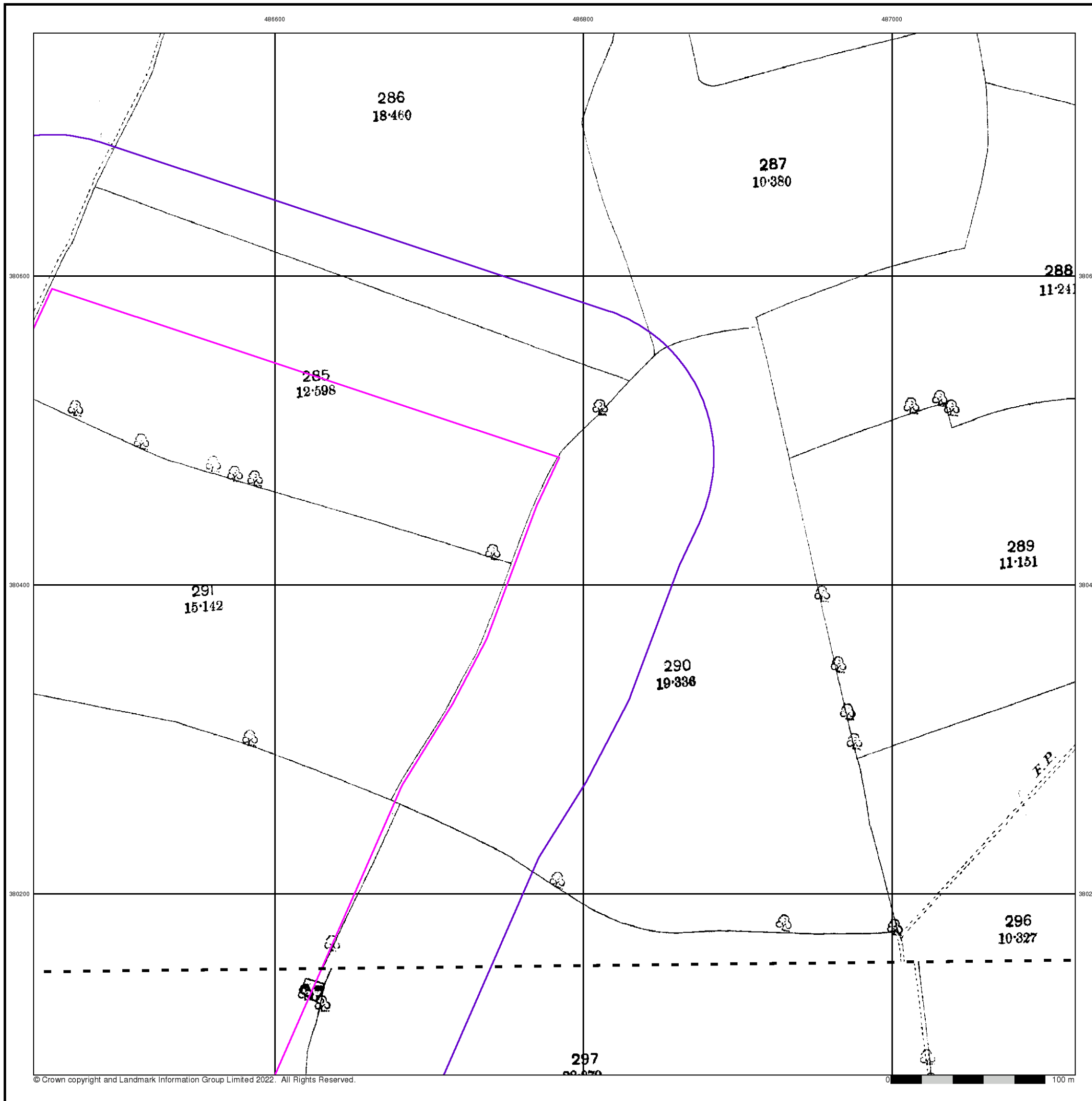

Lincolnshire

Published 1906

Source map scale - 1:2,500

The historical maps shown were reproduced from maps predominantly held at the scale adopted for England, Wales and Scotland in the 1840's. In 1854 the 1:2,500 scale was adopted for mapping urban areas and by 1896 it covered the whole of what were considered to be the cultivated parts of Great Britain. The published date given below is often some years later than the surveyed date. Before 1938, all OS maps were based on the Cassini Projection, with independent surveys of a single county or group of counties, giving rise to significant inaccuracies in outlying areas.

Map Name(s) and Date(s)

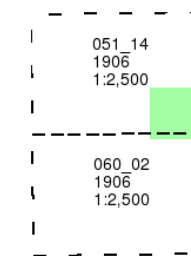

Historical Map - Segment F7

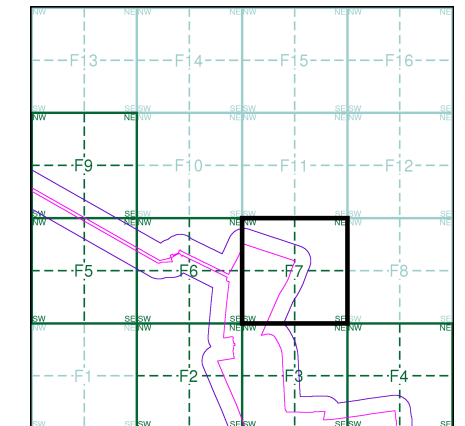

Order Details

Order Number: 298001007_1_1
 Customer Ref: 21-1098.04
 National Grid Reference: 486340, 380210
 Slice: F
 Site Area (Ha): 471.82
 Search Buffer (m): 100

Site Details

West Barton 1

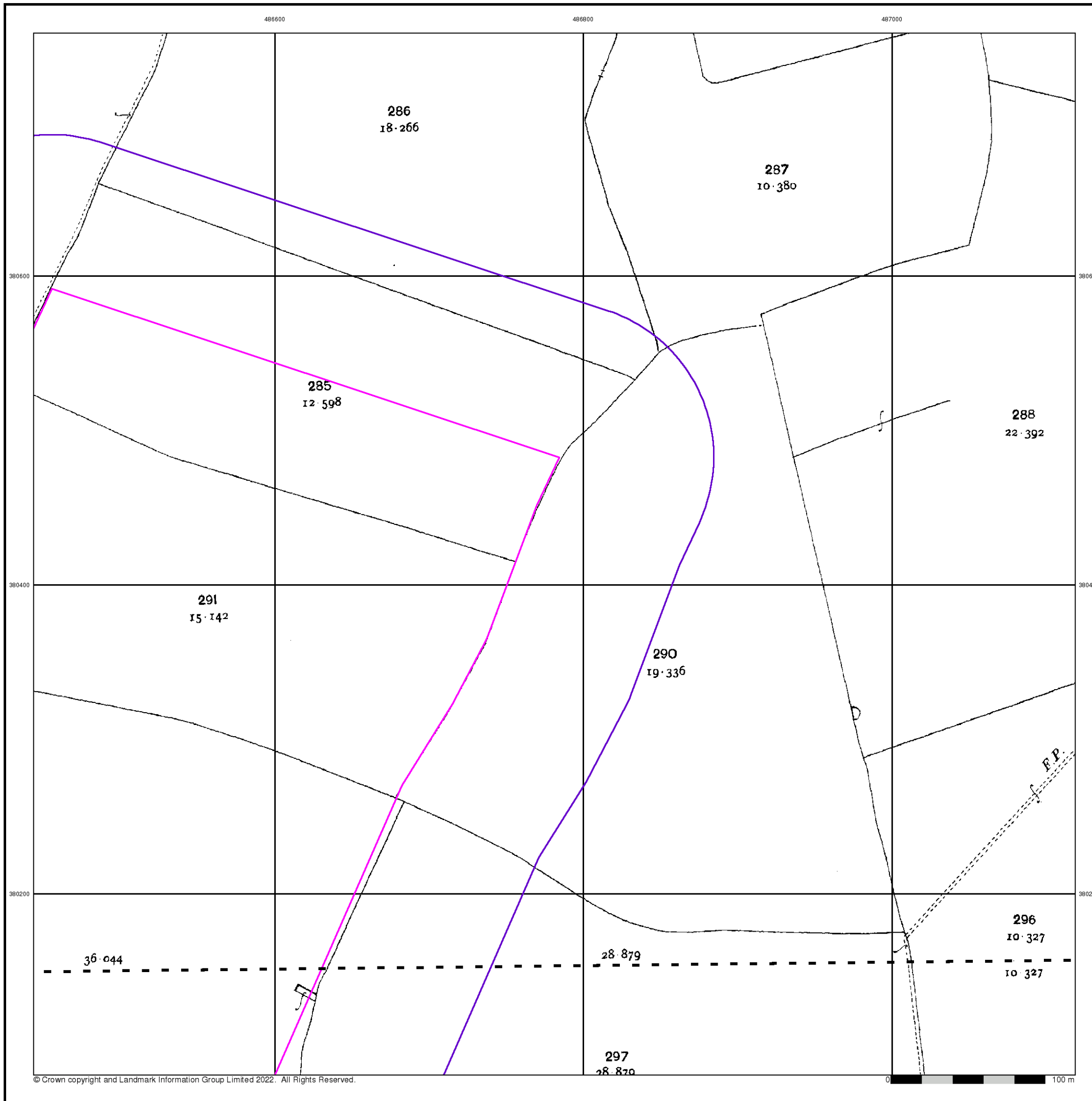

Lincolnshire

Published 1920

Source map scale - 1:2,500

The historical maps shown were reproduced from maps predominantly held at the scale adopted for England, Wales and Scotland in the 1840's. In 1854 the 1:2,500 scale was adopted for mapping urban areas and by 1896 it covered the whole of what were considered to be the cultivated parts of Great Britain. The published date given below is often some years later than the surveyed date. Before 1938, all OS maps were based on the Cassini Projection, with independent surveys of a single county or group of counties, giving rise to significant inaccuracies in outlying areas.

Map Name(s) and Date(s)

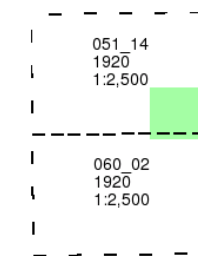

Historical Map - Segment F7

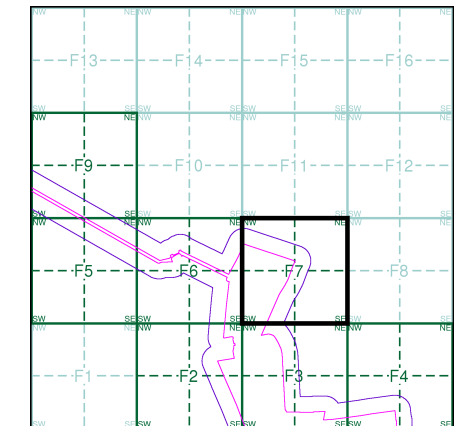

Order Details

Order Number: 298001007_1_1
 Customer Ref: 21-1098.04
 National Grid Reference: 486340, 380210
 Slice: F
 Site Area (Ha): 471.82
 Search Buffer (m): 100

Site Details

West Barton 1

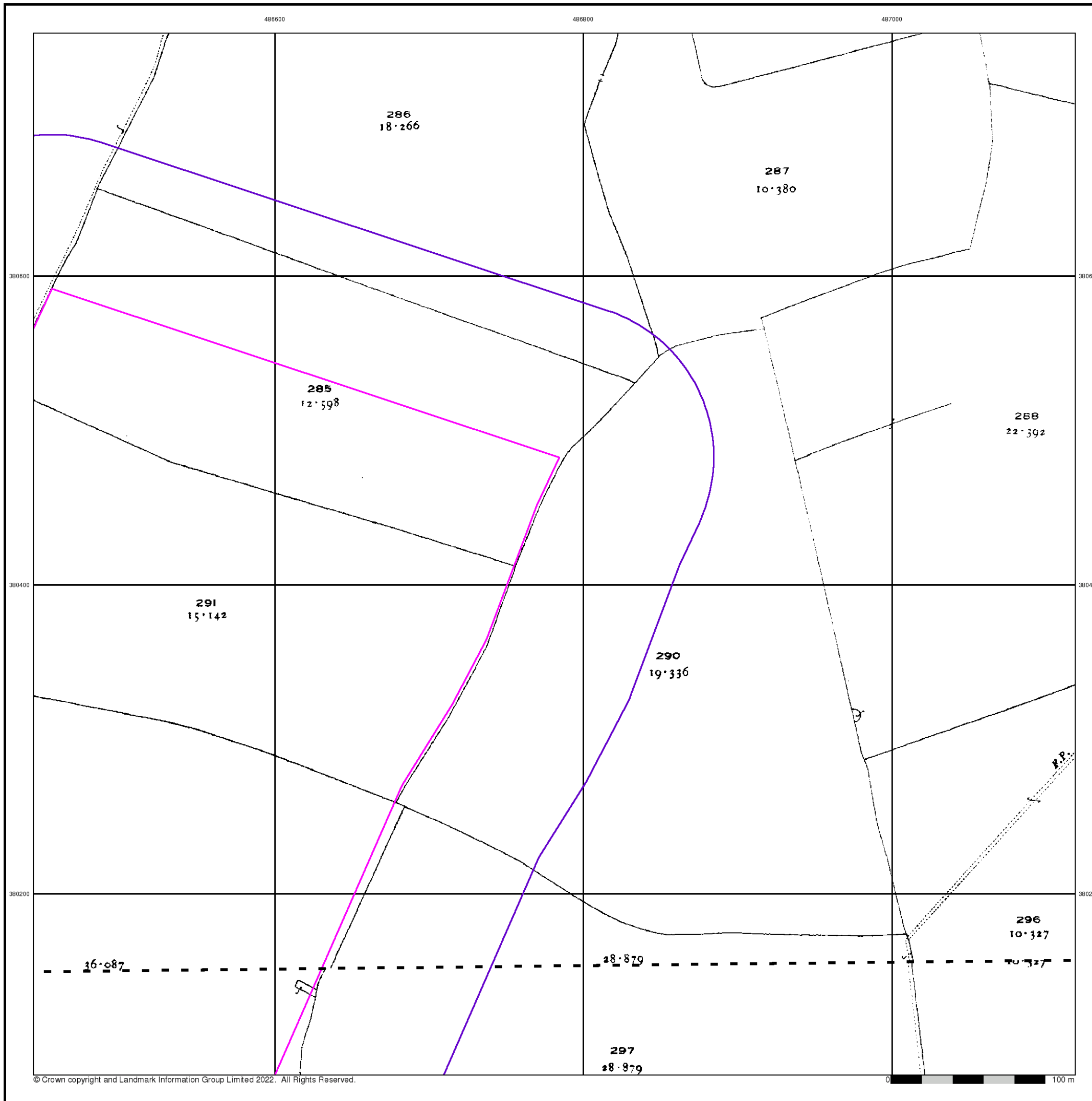

Ordnance Survey Plan

Published 1975

Source map scale - 1:2,500

The historical maps shown were reproduced from maps predominantly held at the scale adopted for England, Wales and Scotland in the 1840's. In 1854 the 1:2,500 scale was adopted for mapping urban areas and by 1896 it covered the whole of what were considered to be the cultivated parts of Great Britain. The published date given below is often some years later than the surveyed date. Before 1938, all OS maps were based on the Cassini Projection, with independent surveys of a single county or group of counties, giving rise to significant inaccuracies in outlying areas.

Map Name(s) and Date(s)

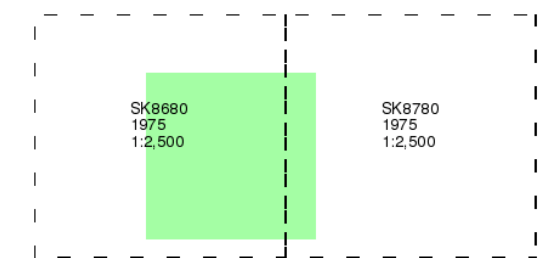

Historical Map - Segment F7

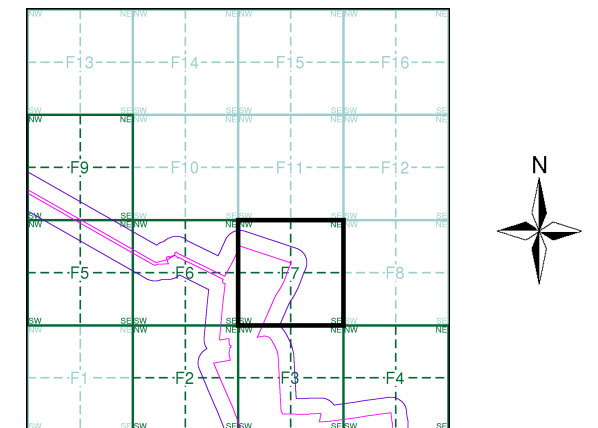

Order Details

Order Number: 298001007_1_1
 Customer Ref: 21-1098.04
 National Grid Reference: 486340, 380210
 Slice: F
 Site Area (Ha): 471.82
 Search Buffer (m): 100

Site Details

West Barton 1

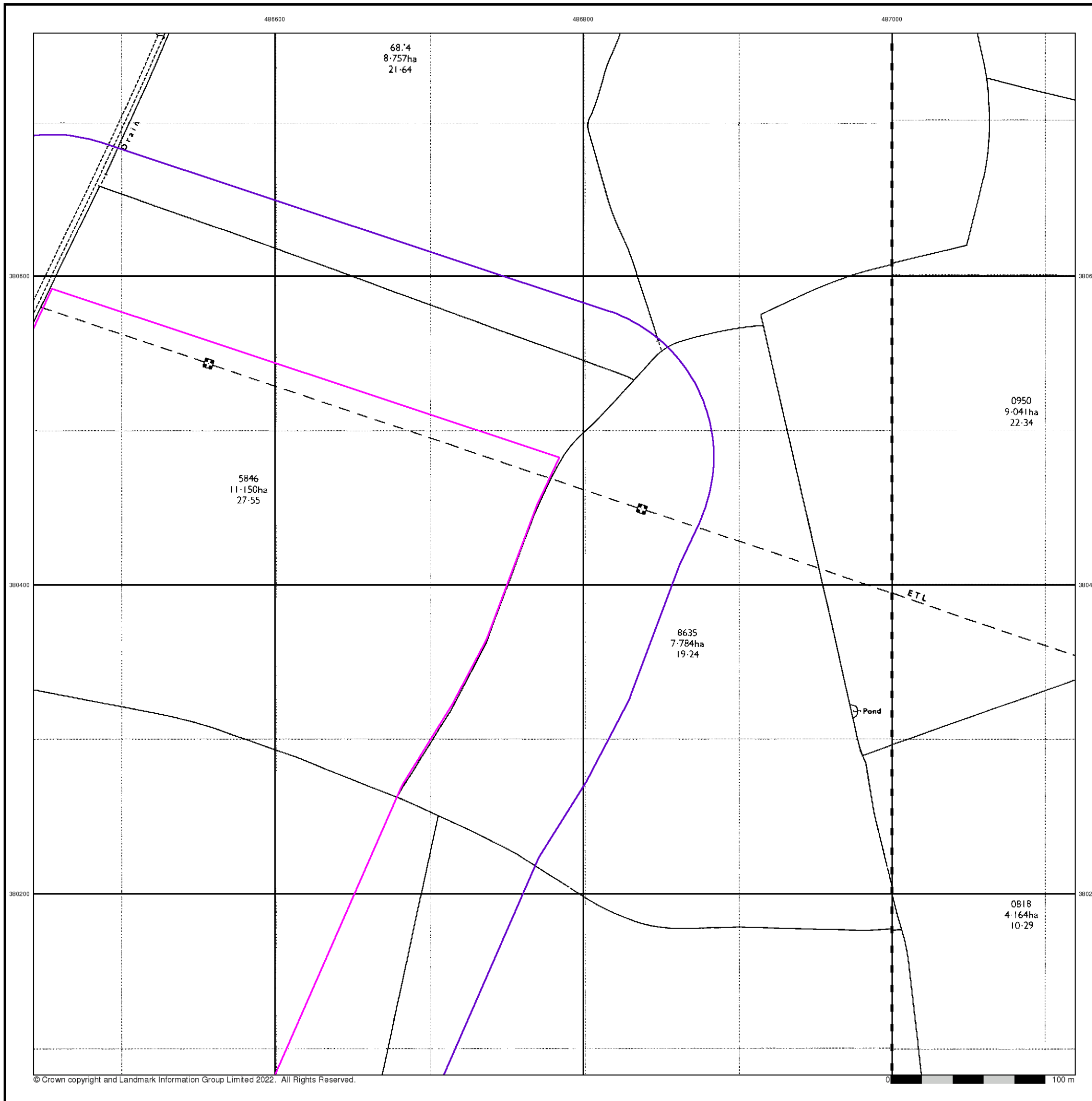

Large-Scale National Grid Data

Published 1994

Source map scale - 1:2,500

'Large Scale National Grid Data' superseded SIM cards (Ordnance Survey's 'Survey of Information on Microfilm') in 1992, and continued to be produced until 1999. These maps were the fore-runners of digital mapping and so provide detailed information on houses and roads, but tend to show less topographic features such as vegetation. These maps were produced at both 1:2,500 and 1:1,250 scales.

Map Name(s) and Date(s)

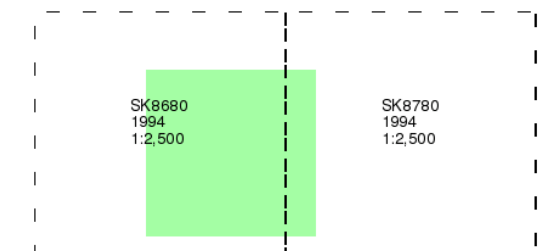

Historical Map - Segment F7

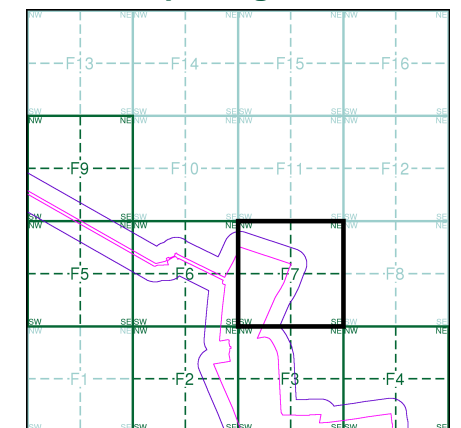

Order Details

Order Number: 298001007_1_1
 Customer Ref: 21-1098.04
 National Grid Reference: 486340, 380210
 Slice: F
 Site Area (Ha): 471.82
 Search Buffer (m): 100

Site Details

West Barton 1

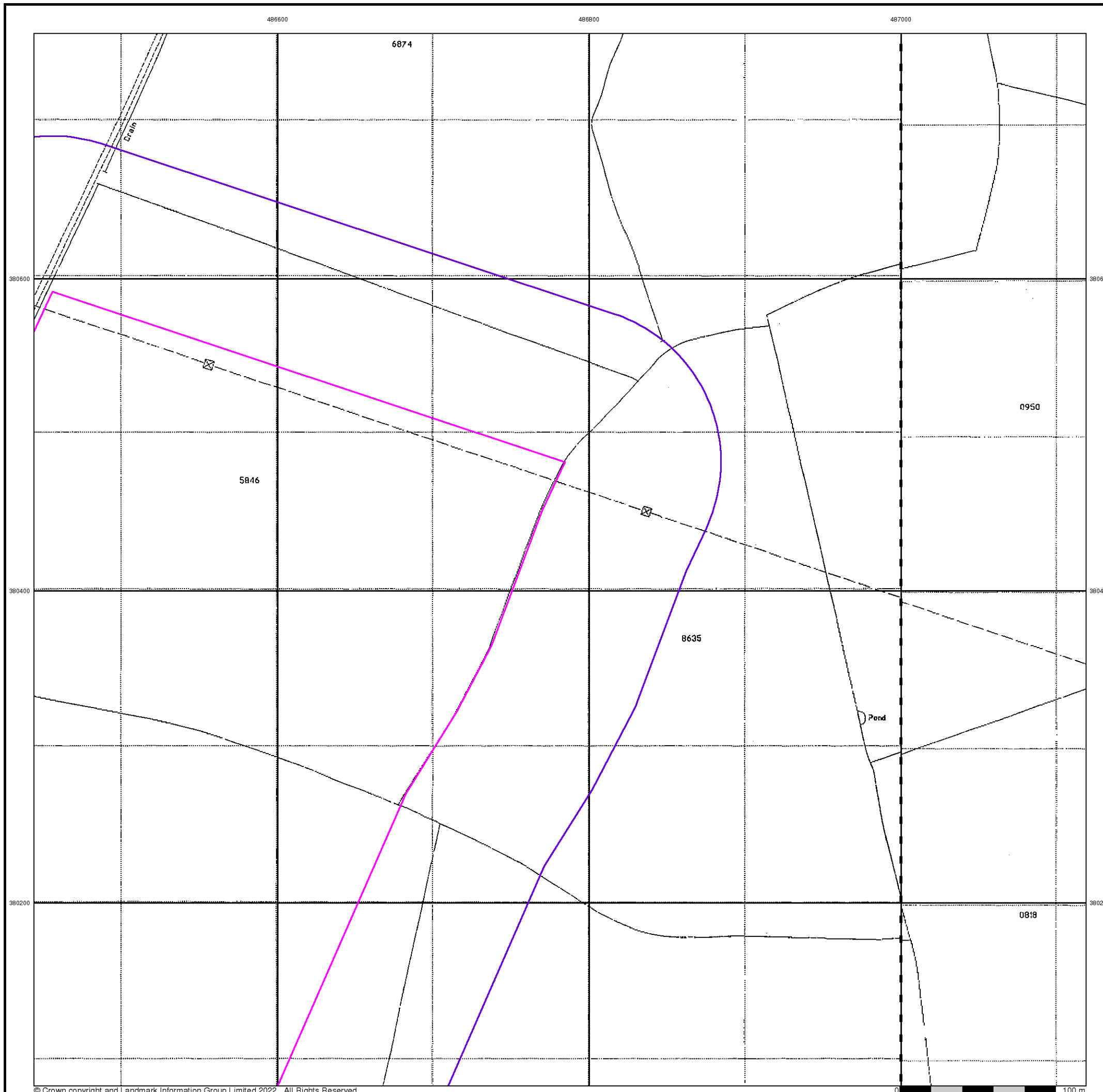

Historical Mapping Legends

Ordnance Survey County Series and Ordnance Survey Plan 1:2,500

Quarry **Gravel Pit** **Sand Pit**
Clay Pit **Shingle** **Refuse Heap**
Sloping Masonry **Flat Rock**
Marsh **Reeds** **Osiers**
Rough Pasture **Furze** **Wood**
Mixed Wood **Brushwood** **Orchard**
Fir **Ford** **Stepping Stones**
Ferry **Waterfall** **Lock**
Trig. Station **Altitude at Trig. Station**
B.M. 325.9 **Bench Mark** **Surface Level**
Arrow denotes flow of water **Antiquities (site of)**
Cutting **Embankment**
Railway crossing Road **Level Crossing** **Road crossing Railway**
Railway crossing River or Canal **Road over single stream** **Road over River or Canal**
County Boundary (Geographical)
County & Civil Parish Boundary
Administrative County & Civil Parish Boundary
County Borough Boundary (England)
County Burgh Boundary (Scotland)
Boundary Post or Stone **Police Call Box**
B.R. Bridle Road **Pump**
E.P. Electricity Pylon **S.P. Signal Post**
F.B. Foot Bridge **Sl. Sluice**
F.P. Foot Path **Sp. Spring**
G.P. Guide Post or Board **T.C.B. Telephone Call Box**
M.S. Mile Stone **Tr. Trough**
M.P. M.R. Mooring Post or Ring **W. Well**

Ordnance Survey Plan, Additional SIMs and Supply of Unpublished Survey Information 1:2,500 and 1:1,250

Inactive Quarry, Chalk Pit or Clay Pit **Active Quarry, Chalk Pit or Clay Pit**
Rock **Boulders**
Cliff **Slopes** **Top**
Roofed Building **Glazed Roof Building**
Sloping Masonry **Archway**
Non-Coniferous Tree (surveyed) **Coniferous Tree (surveyed)**
Non-Coniferous Trees (not surveyed) **Coniferous Trees (not surveyed)**
Orchard Tree **Scrub** **Bracken**
Coppice, Osier **Reeds** **Marsh, Saltings**
Rough Grassland **Heath** **Culvert**
Direction of water flow **Bench Mark** **Antiquity (site of)**
Cave Entrance **Triangulation Station** **Electricity Pylon**
Electricity Transmission Line
County Boundary (Geographical)
County & Civil Parish Boundary
Civil Parish Boundary
Admin. County or County Bor. Boundary
London Borough Boundary
Symbol marking point where boundary mereing changes
BH Beer House **P Pillar, Pole or Post**
BP, BS Boundary Post or Stone **PO Post Office**
Cn, C Capstan, Crane **PC Public Convenience**
Chy Chimney **PH Public House**
D Fn Drinking Fountain **Pp Pump**
EI P Electricity Pillar or Post **SB, S Br Signal Box or Bridge**
FAP Fire Alarm Pillar **SP, SL Signal Post or Light**
FB Foot Bridge **Spr Spring**
GP Guide Post **Tk Tank or Track**
H Hydrant or Hydraulic **TCB Telephone Call Box**
LC Level Crossing **TCP Telephone Call Post**
MH Manhole **Tr Trough**
MP Mile Post or Mooring Post **Wr Pt, Wr T Water Point, Water Tap**
MS Mile Stone **W Well**
NTL Normal Tidal Limit **Wd Pp Wind Pump**

Large-Scale National Grid Data 1:2,500 and 1:1,250

Cliff **Slopes** **Top**
Rock **Rock (scattered)**
Boulders **Boulders (scattered)**
Positioned Boulder **Scree**
Non-Coniferous Tree (surveyed) **Coniferous Tree (surveyed)**
Non-Coniferous Trees (not surveyed) **Coniferous Trees (not surveyed)**
Orchard Tree **Scrub** **Bracken**
Coppice, Osier **Reeds** **Marsh, Saltings**
Rough Grassland **Heath** **Culvert**
Direction of water flow **Triangulation Station** **Antiquity (site of)**
Electricity Transmission Line **Electricity Pylon**
B.M. 231.60m Bench Mark **Buildings with Building Seed**
Roofed Building **Glazed Roof Building**
Civil parish/community boundary
District boundary
County boundary
Boundary post/stone
Boundary mereing symbol (note: these always appear in opposed pairs or groups of three)
Bks Barracks **P Pillar, Pole or Post**
Bty Battery **PO Post Office**
Cemy Cemetery **PC Public Convenience**
Chy Chimney **Pp Pump**
Cis Cistern **Ppg Sta Pumping Station**
Dismtd Rly Dismantled Railway **PW Place of Worship**
EI Gen Sta Electricity Generating Station **Sewage Ppg Sta Sewage Pumping Station**
EI P Electricity Pole, Pillar **SB, S Br Signal Box or Bridge**
EI Sub Sta Electricity Sub Station **SP, SL Signal Post or Light**
FB Filter Bed **Spr Spring**
Fn / D Fn Fountain / Drinking Ftn. **Tk Tank or Track**
Gas Gov Gas Valve Compound **Tr Trough**
GVC Gas Governor **Wd Pp Wind Pump**
GP Guide Post **Wr Pt, Wr T Water Point, Water Tap**
MH Manhole **Wks Works (building or area)**
MP, MS Mile Post or Mile Stone **W Well**

Historical Mapping & Photography included:

Mapping Type	Scale	Date	Pg
Lincolnshire	1:2,500	1886	2
Lincolnshire	1:2,500	1906	3
Lincolnshire	1:2,500	1920	4
Ordnance Survey Plan	1:2,500	1974	5
Large-Scale National Grid Data	1:2,500	1994	6

Historical Map - Segment F9

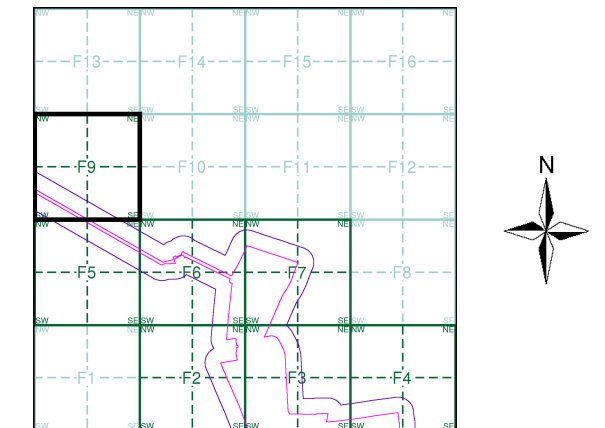

Order Details

Order Number: 298001007_1_1
 Customer Ref: 21-1098.04
 National Grid Reference: 486340, 380210
 Slice: F
 Site Area (Ha): 471.82
 Search Buffer (m): 100

Site Details

West Barton 1

Lincolnshire

Published 1886

Source map scale - 1:2,500

The historical maps shown were reproduced from maps predominantly held at the scale adopted for England, Wales and Scotland in the 1840's. In 1854 the 1:2,500 scale was adopted for mapping urban areas and by 1896 it covered the whole of what were considered to be the cultivated parts of Great Britain. The published date given below is often some years later than the surveyed date. Before 1938, all OS maps were based on the Cassini Projection, with independent surveys of a single county or group of counties, giving rise to significant inaccuracies in outlying areas.

Map Name(s) and Date(s)

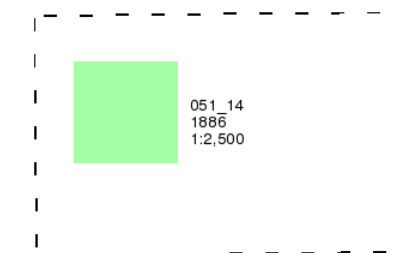

Historical Map - Segment F9

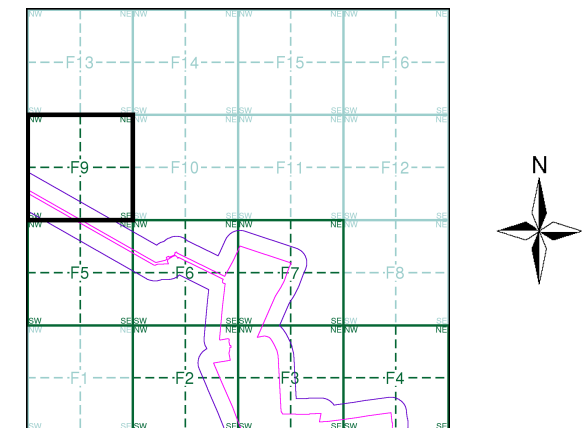

Order Details

Order Number: 298001007_1_1
 Customer Ref: 21-1098.04
 National Grid Reference: 486340, 380210
 Slice: F
 Site Area (Ha): 471.82
 Search Buffer (m): 100

Site Details

West Barton 1

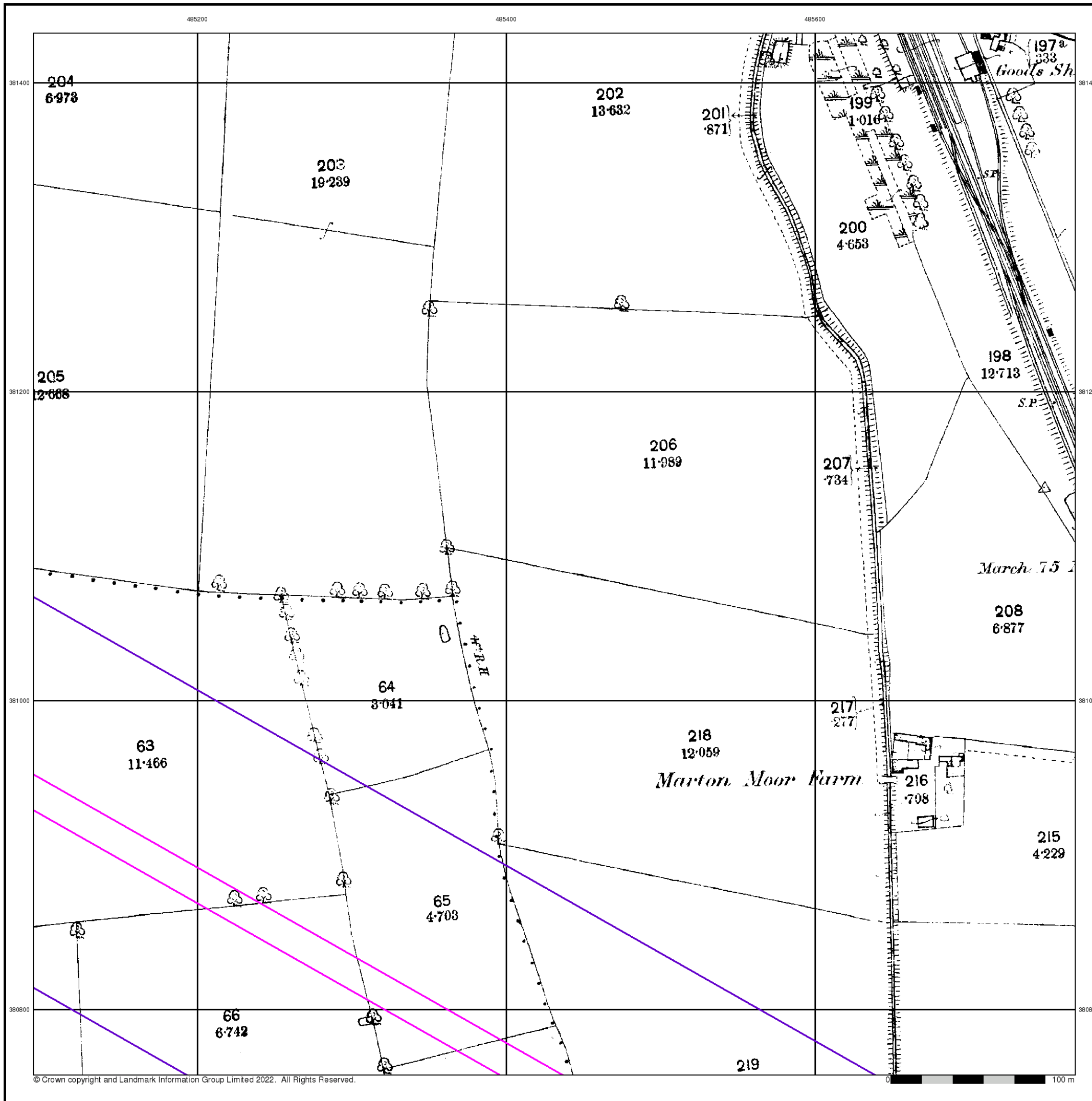

Lincolnshire

Published 1906

Source map scale - 1:2,500

The historical maps shown were reproduced from maps predominantly held at the scale adopted for England, Wales and Scotland in the 1840's. In 1854 the 1:2,500 scale was adopted for mapping urban areas and by 1896 it covered the whole of what were considered to be the cultivated parts of Great Britain. The published date given below is often some years later than the surveyed date. Before 1938, all OS maps were based on the Cassini Projection, with independent surveys of a single county or group of counties, giving rise to significant inaccuracies in outlying areas.

Map Name(s) and Date(s)

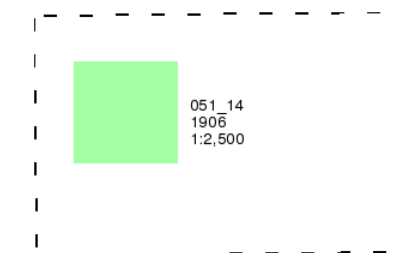

Historical Map - Segment F9

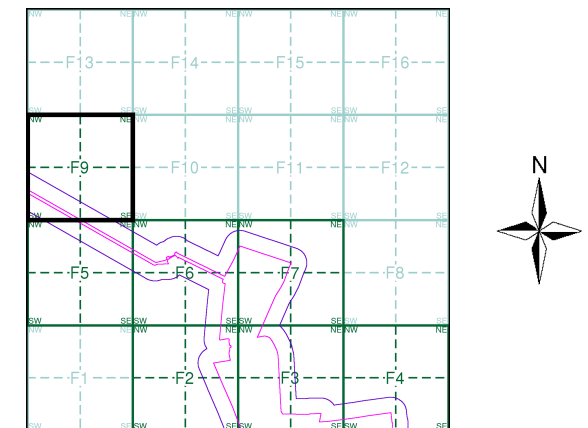

Order Details

Order Number: 298001007_1_1
 Customer Ref: 21-1098.04
 National Grid Reference: 486340, 380210
 Slice: F
 Site Area (Ha): 471.82
 Search Buffer (m): 100

Site Details

West Barton 1

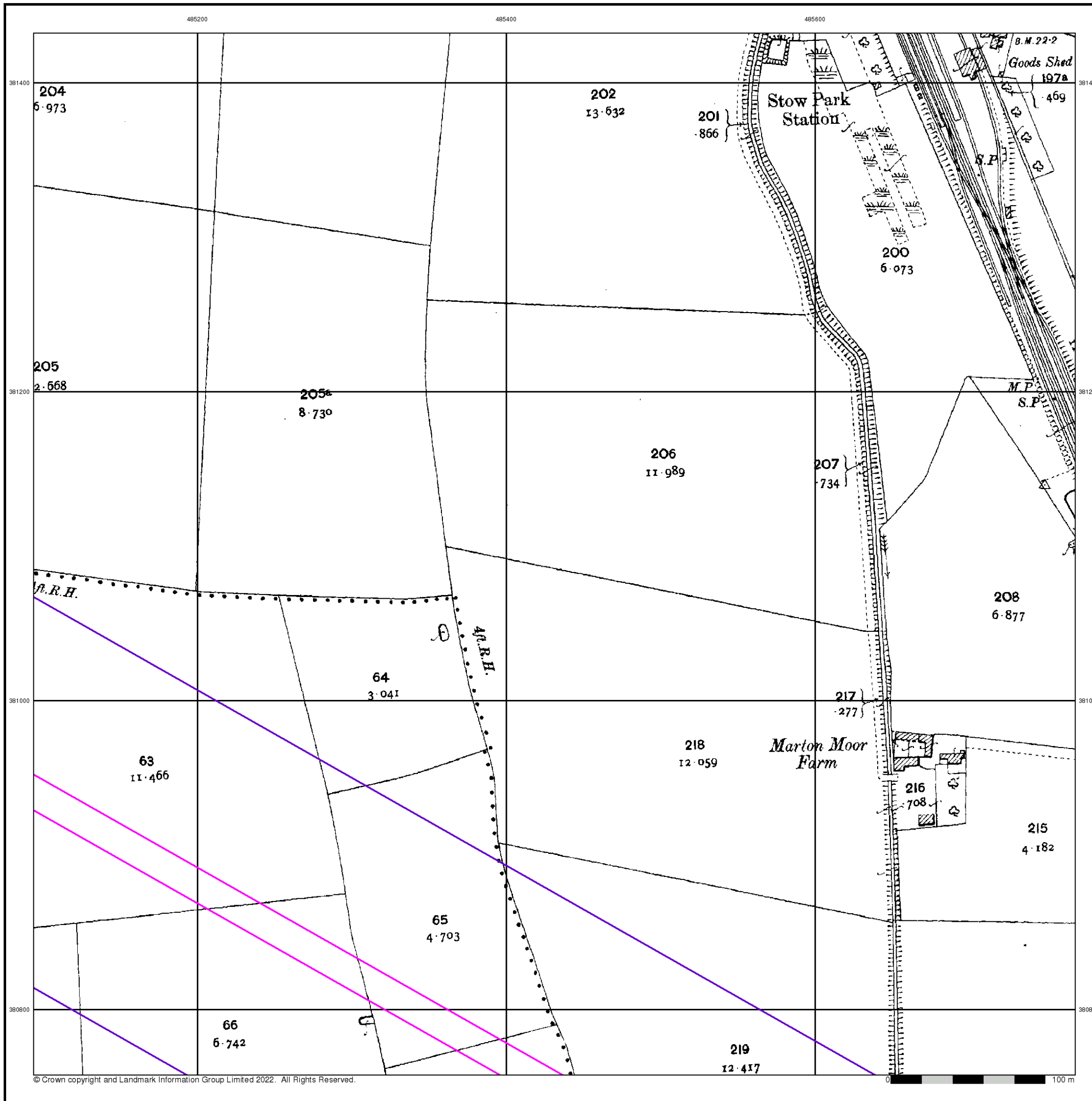

Lincolnshire

Published 1920

Source map scale - 1:2,500

The historical maps shown were reproduced from maps predominantly held at the scale adopted for England, Wales and Scotland in the 1840's. In 1854 the 1:2,500 scale was adopted for mapping urban areas and by 1896 it covered the whole of what were considered to be the cultivated parts of Great Britain. The published date given below is often some years later than the surveyed date. Before 1938, all OS maps were based on the Cassini Projection, with independent surveys of a single county or group of counties, giving rise to significant inaccuracies in outlying areas.

Map Name(s) and Date(s)

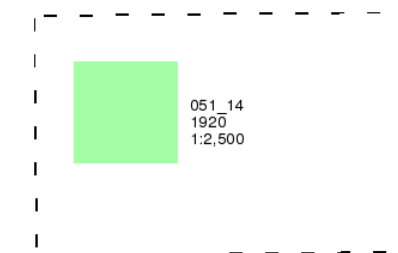

Historical Map - Segment F9

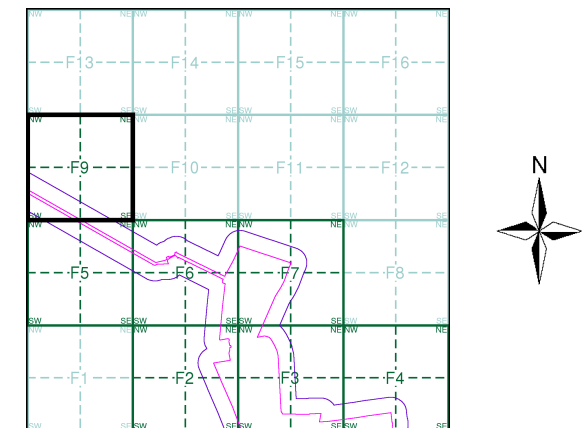

Order Details

Order Number: 298001007_1_1
 Customer Ref: 21-1098.04
 National Grid Reference: 486340, 380210
 Slice: F
 Site Area (Ha): 471.82
 Search Buffer (m): 100

Site Details

West Barton 1

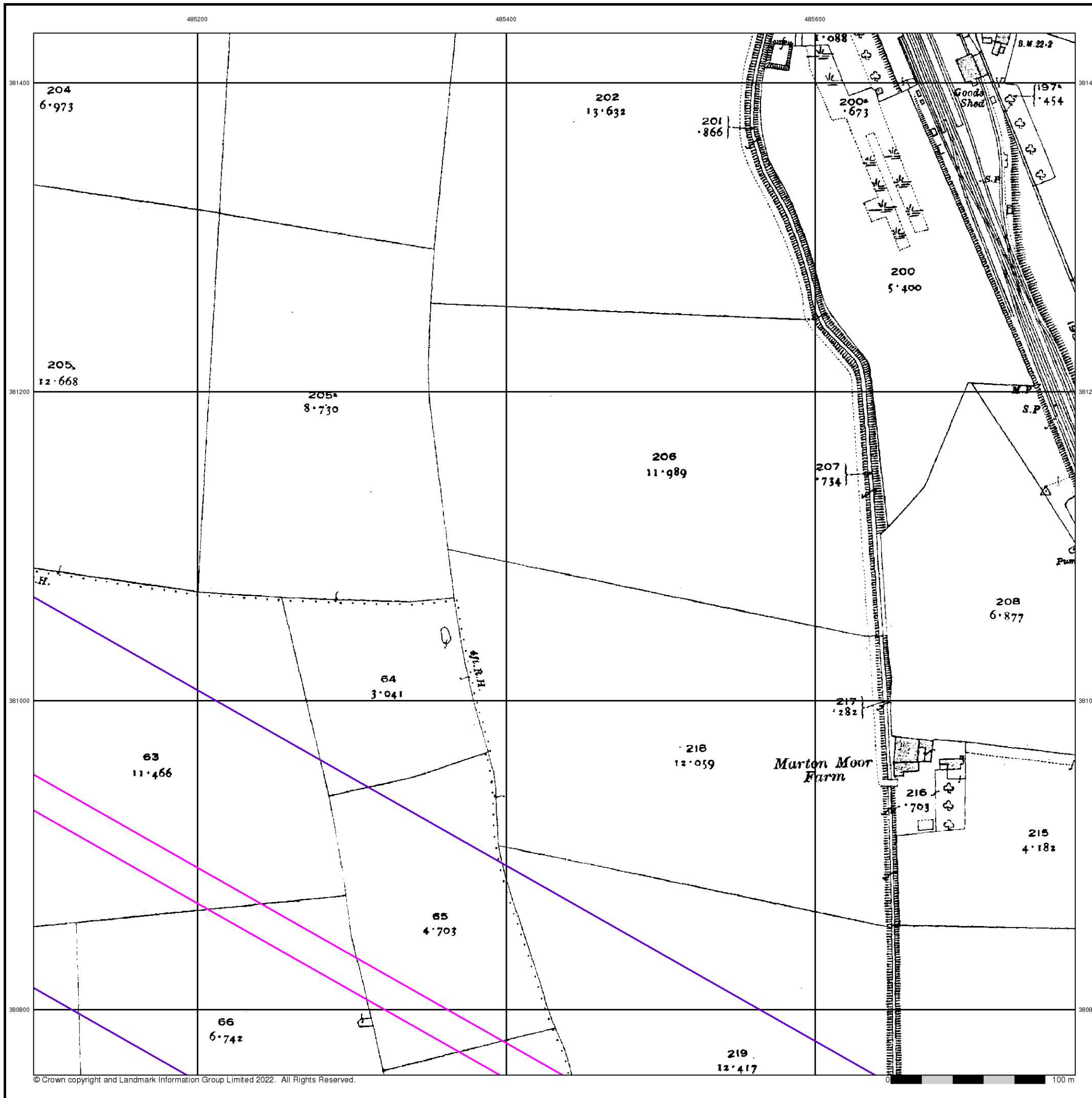

Ordnance Survey Plan

Published 1974

Source map scale - 1:2,500

The historical maps shown were reproduced from maps predominantly held at the scale adopted for England, Wales and Scotland in the 1840's. In 1854 the 1:2,500 scale was adopted for mapping urban areas and by 1896 it covered the whole of what were considered to be the cultivated parts of Great Britain. The published date given below is often some years later than the surveyed date. Before 1938, all OS maps were based on the Cassini Projection, with independent surveys of a single county or group of counties, giving rise to significant inaccuracies in outlying areas.

Map Name(s) and Date(s)

SK8581	1974	1:2,500
SK8580	1974	1:2,500

Historical Map - Segment F9

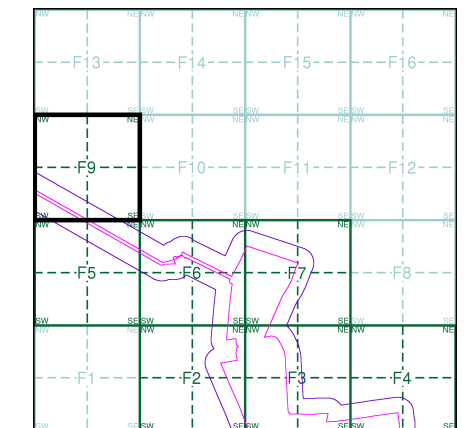

Order Details

Order Number: 298001007_1_1
 Customer Ref: 21-1098.04
 National Grid Reference: 486340, 380210
 Slice: F
 Site Area (Ha): 471.82
 Search Buffer (m): 100

Site Details

West Barton 1

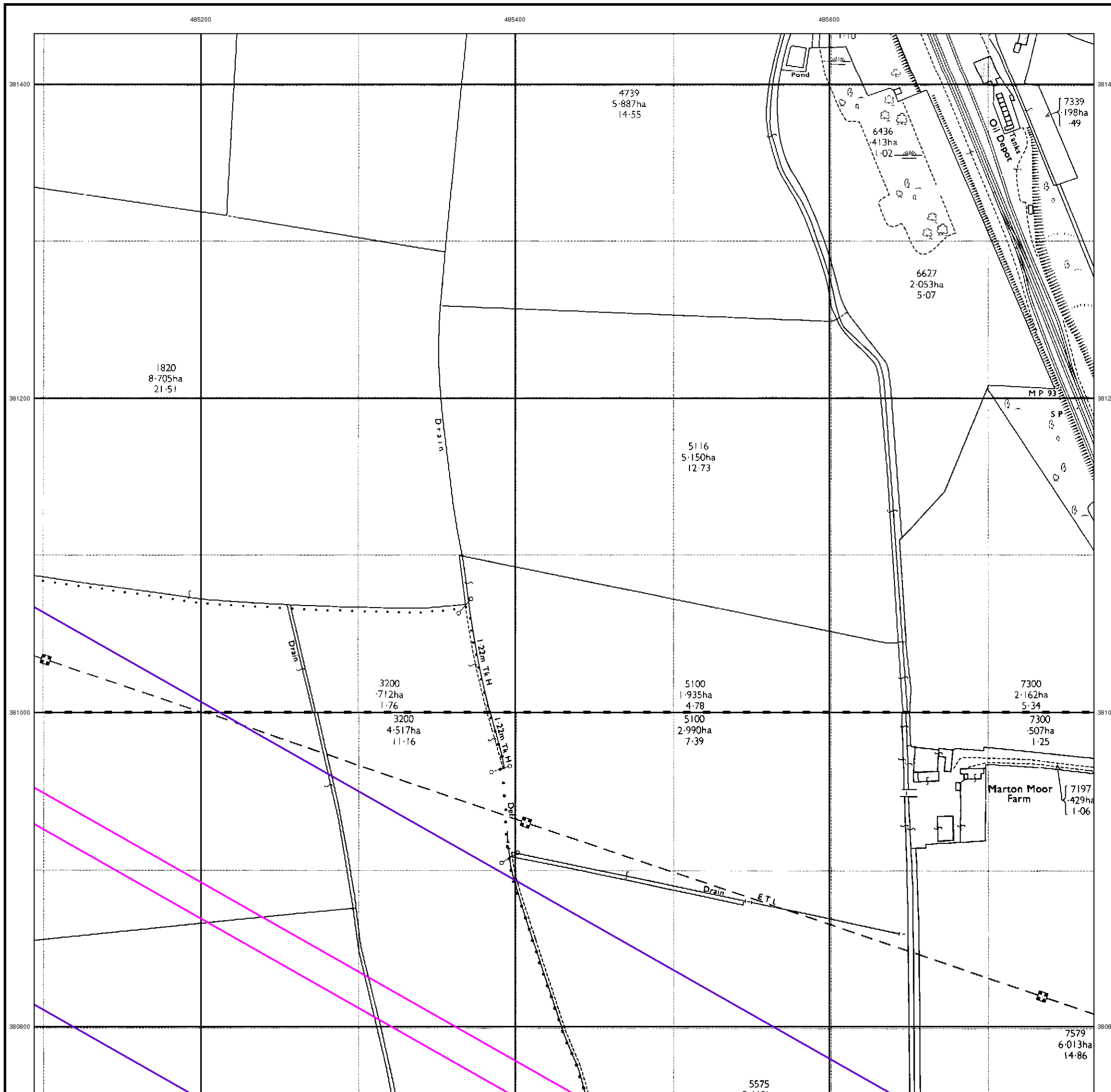

Large-Scale National Grid Data

Published 1994

Source map scale - 1:2,500

'Large Scale National Grid Data' superseded SIM cards (Ordnance Survey's 'Survey of Information on Microfilm') in 1992, and continued to be produced until 1999. These maps were the fore-runners of digital mapping and so provide detailed information on houses and roads, but tend to show less topographic features such as vegetation. These maps were produced at both 1:2,500 and 1:1,250 scales.

Map Name(s) and Date(s)

SK8581	
1994	
1:2,500	
SK8580	
1994	
1:2,500	

Historical Map - Segment F9

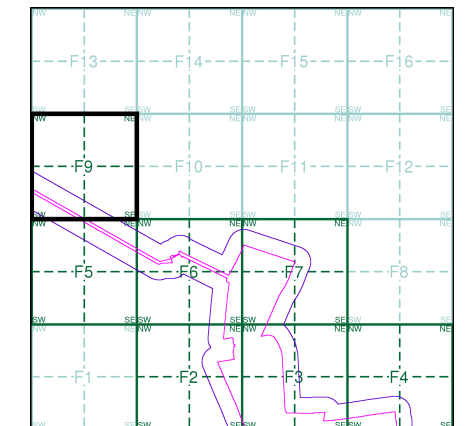

Order Details

Order Number: 298001007_1_1
Customer Ref: 21-1098.04
National Grid Reference: 486340, 380210
Slice: F
Site Area (Ha): 471.82
Search Buffer (m): 100

Site Details

West Barton 1

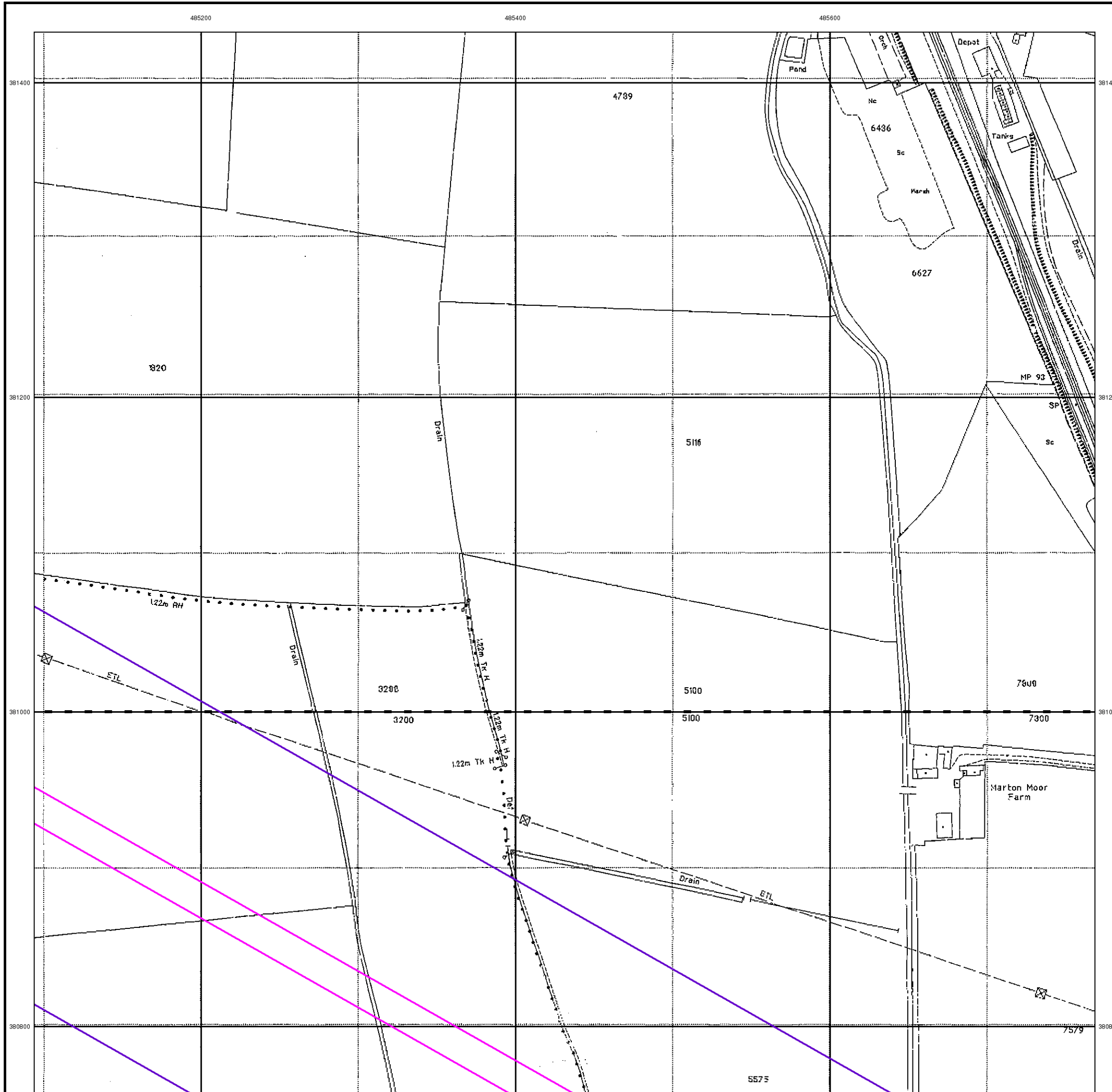

Historical Mapping Legends

Ordnance Survey County Series 1:10,560

- Gravel Pit
- Sand Pit
- Other Pits
- Quarry
- Shingle
- Orchard
- Osiers
- Reeds
- Marsh
- Mixed Wood
- Deciduous
- Brushwood
- Fir
- Furze
- Rough Pasture
- Arrow denotes flow of water
- Trigonometrical Station
- Site of Antiquities
- Bench Mark
- Pump, Guide Post, Signal Post
- Well, Spring, Boundary Post
- 285** Surface Level
- Sketched Contour
- Instrumental Contour
- Main Roads
- Minor Roads
- Sunken Road
- Raised Road
- Road over Railway
- Railway over River
- Railway over Road
- Level Crossing
- Road over River or Canal
- Road over Stream
- Road over Stream
- County Boundary (Geographical)
- County & Civil Parish Boundary
- Administrative County & Civil Parish Boundary
- County Borough Boundary (England)
- County Burgh Boundary (Scotland)
- Rural District Boundary
- Civil Parish Boundary

Ordnance Survey Plan 1:10,000

- Chalk Pit, Clay Pit or Quarry
- Gravel Pit
- Sand Pit
- Disused Pit or Quarry
- Refuse or Slag Heap
- Lake, Loch or Pond
- Dunes
- Boulders
- Coniferous Trees
- Non-Coniferous Trees
- Orchard
- Scrub
- Coppice
- Bracken
- Heath
- Rough Grassland
- Marsh
- Reeds
- Saltings
- Building
- Glasshouse
- Sloping Masonry
- Pylon
- Electricity Transmission Line
- Pole
- Cutting
- Embankment
- Standard Gauge Multiple Track
- Standard Gauge Single Track
- Siding, Tramway or Mineral Line
- Narrow Gauge
- Geographical County
- Administrative County, County Borough or County of City
- Municipal Borough, Urban or Rural District, Burgh or District Council
- Borough, Burgh or County Constituency
- Civil Parish
- BP, BS** Boundary Post or Stone
- Ch** Church
- CH** Club House
- F E Sta** Fire Engine Station
- FB** Foot Bridge
- Fn** Fountain
- GP** Guide Post
- MP** Mile Post
- MS** Mile Stone
- Pol Sta** Police Station
- PO** Post Office
- PC** Public Convenience
- PH** Public House
- SB** Signal Box
- Spr** Spring
- TCB** Telephone Call Box
- TCP** Telephone Call Post
- W** Well

1:10,000 Raster Mapping

- Gravel Pit
- Rock
- Boulders
- Shingle
- Sand
- Slopes
- General detail
- Overhead detail
- Multi-track railway
- County boundary (England only)
- District, Unitary, Metropolitan, London Borough boundary
- Refuse tip or slag heap
- Rock (scattered)
- Boulders (scattered)
- Mud
- Sand Pit
- Top of cliff
- Underground detail
- Narrow gauge railway
- Single track railway
- Civil, parish or community boundary
- Constituency boundary
- Area of wooded vegetation
- Non-coniferous trees
- Coniferous trees
- Positioned tree
- Coppice or Osiers
- Heath
- Marsh, Salt Marsh or Reeds
- Flow arrows
- Mean high water (springs)
- Mean low water (springs)
- Electricity transmission line (with poles)
- Telephone line (where shown)
- Bench mark (where shown)
- Point feature (e.g. Guide Post or Mile Stone)
- Site of (antiquity)
- General Building
- Important Building



Historical Mapping & Photography included:

Mapping Type	Scale	Date	Pg
Nottinghamshire	1:10,560	1885	2
Nottinghamshire	1:10,560	1900	3
Lincolnshire	1:10,560	1921 - 1922	4
Lincolnshire	1:10,560	1947	5
Ordnance Survey Plan	1:10,000	1956	6
Ordnance Survey Plan	1:10,000	1956	7
Ordnance Survey Plan	1:10,000	1974 - 1979	8
Ordnance Survey Plan	1:10,000	1980	9
10K Raster Mapping	1:10,000	2000	10
Street View	Variable		11

Historical Map - Slice A

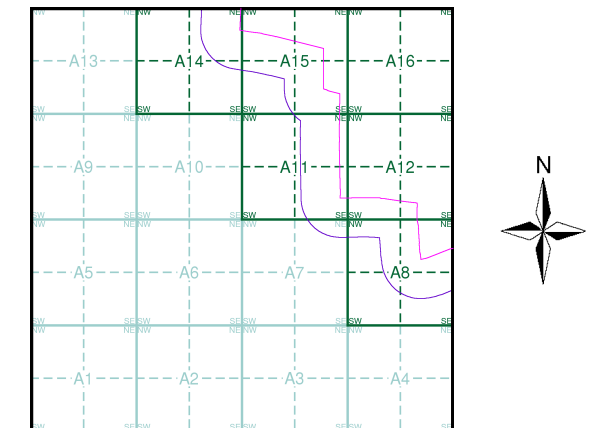

Order Details

Order Number: 298001706_1_1
 Customer Ref: 21-2098.04
 National Grid Reference: 480860, 381630
 Slice: A
 Site Area (Ha): 1355.61
 Search Buffer (m): 250

Site Details

West Barton 2



Tel: 0844 844 9952
 Fax: 0844 844 9951
 Web: [REDACTED]

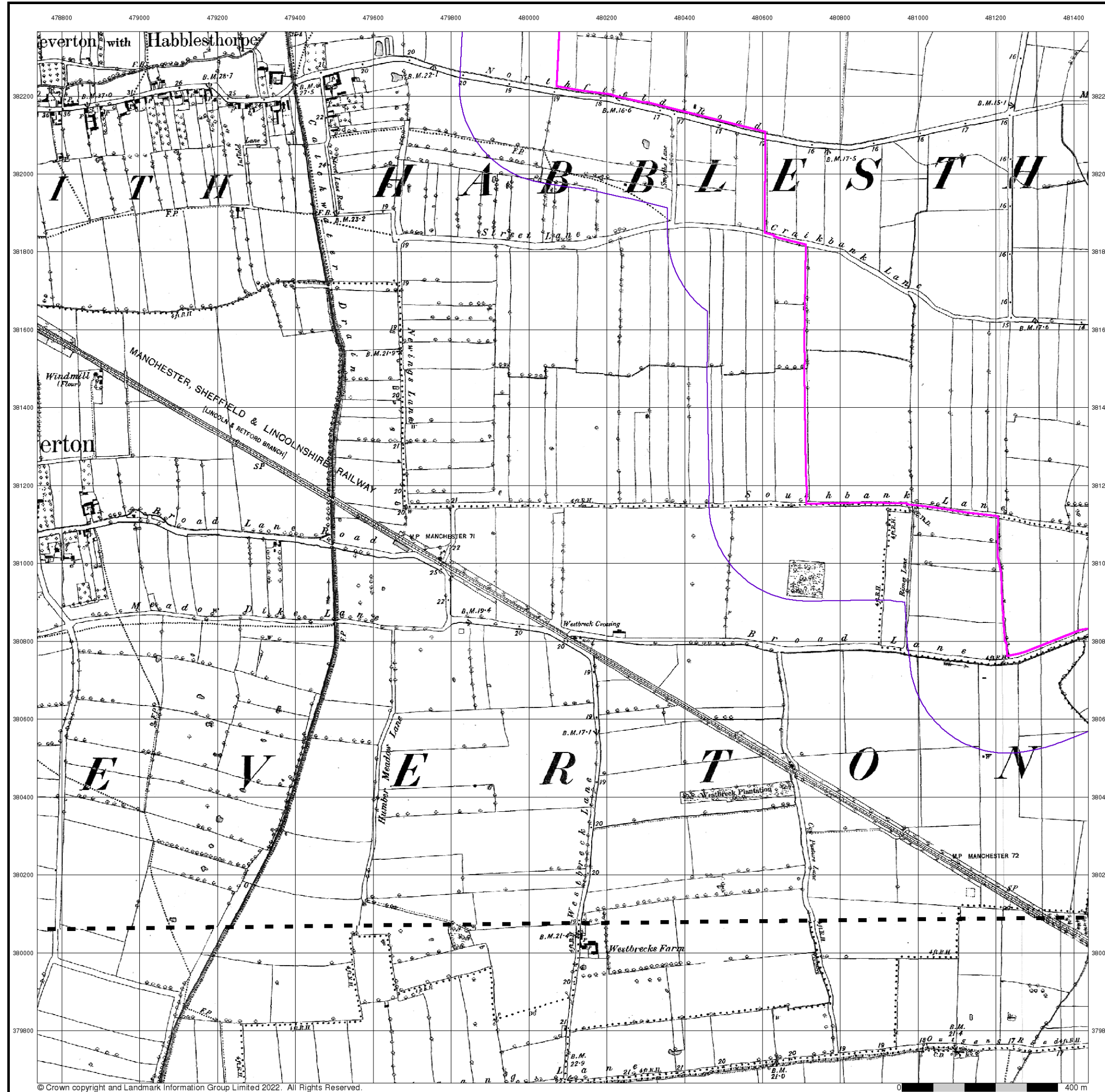

© Crown copyright and Landmark Information Group Limited 2022. All Rights Reserved.



Nottinghamshire

Published 1885

Source map scale - 1:10,560

The historical maps shown were reproduced from maps predominantly held at the scale adopted for England, Wales and Scotland in the 1840's. In 1854 the 1:2,500 scale was adopted for mapping urban areas; these maps were used to update the 1:10,560 maps. The published date given therefore is often some years later than the surveyed date. Before 1938, all OS maps were based on the Cassini Projection, with independent surveys of a single county or group of counties, giving rise to significant inaccuracies in outlying areas. In the late 1940's, a Provisional Edition was produced, which updated the 1:10,560 mapping from a number of sources. The maps appear unfinished - with all military camps and other strategic sites removed. These maps were initially overprinted with the National Grid. In 1970, the first 1:10,000 maps were produced using the Transverse Mercator Projection. The revision process continued until recently, with new editions appearing every 10 years or so for urban areas.

Map Name(s) and Date(s)

010SE
1885
1:10,560
015NE
1885
1:10,560

Historical Map - Slice A

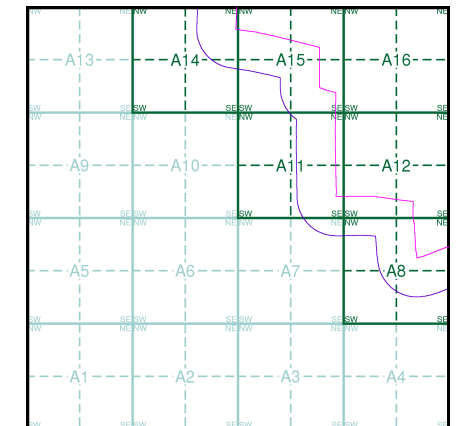

Order Details

Order Number: 298001706_1_1
 Customer Ref: 21-2098.04
 National Grid Reference: 480860, 381630
 Slice: A
 Site Area (Ha): 1355.61
 Search Buffer (m): 250

Site Details

West Barton 2



Tel: 0844 844 9952
 Fax: 0844 844 9951
 Web: [REDACTED]

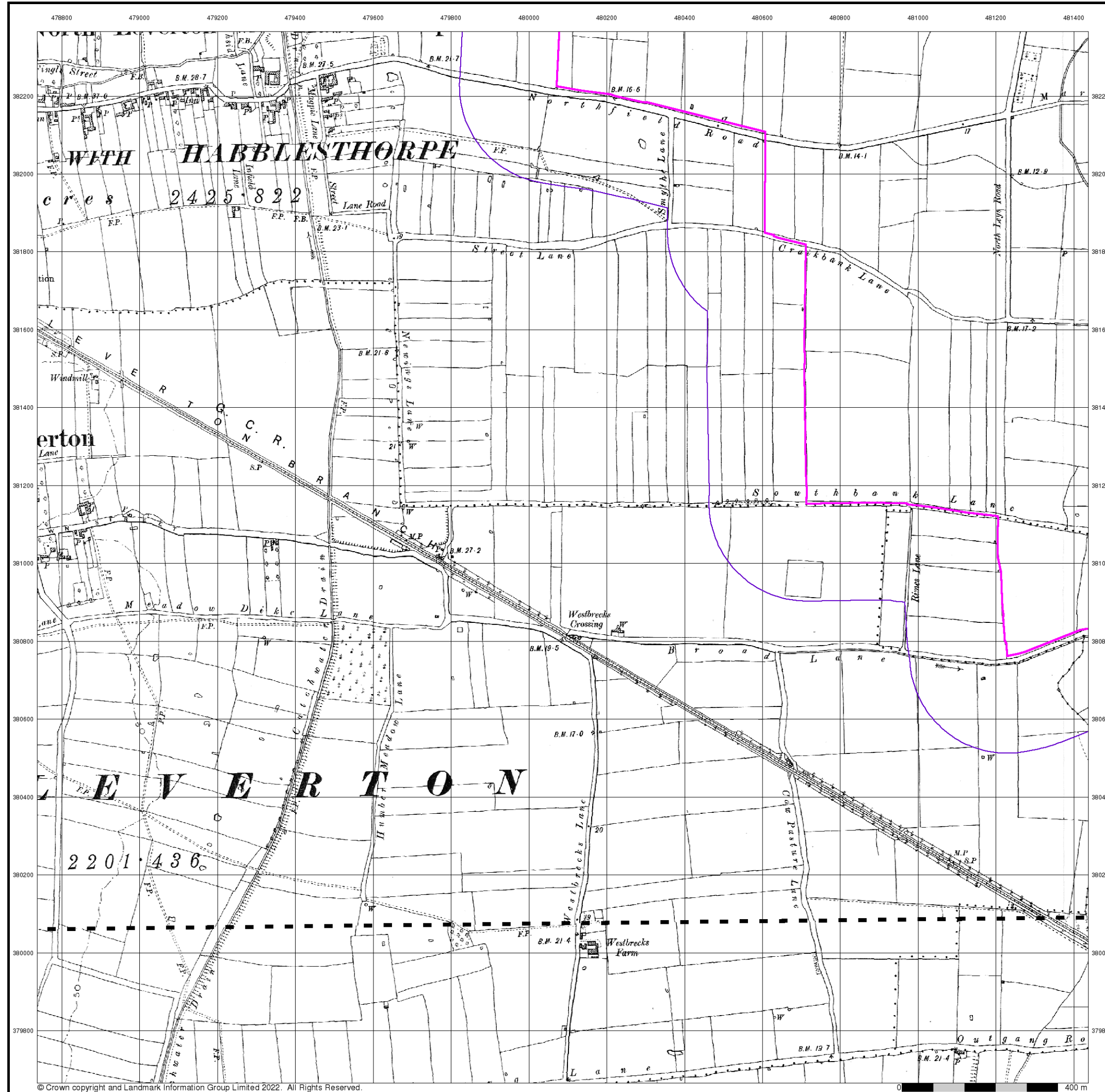

© Crown copyright and Landmark Information Group Limited 2022. All Rights Reserved.



Nottinghamshire

Published 1900

Source map scale - 1:10,560

The historical maps shown were reproduced from maps predominantly held at the scale adopted for England, Wales and Scotland in the 1840's. In 1854 the 1:2,500 scale was adopted for mapping urban areas; these maps were used to update the 1:10,560 maps. The published date given therefore is often some years later than the surveyed date. Before 1938, all OS maps were based on the Cassini Projection, with independent surveys of a single county or group of counties, giving rise to significant inaccuracies in outlying areas. In the late 1940's, a Provisional Edition was produced, which updated the 1:10,560 mapping from a number of sources. The maps appear unfinished - with all military camps and other strategic sites removed. These maps were initially overprinted with the National Grid. In 1970, the first 1:10,000 maps were produced using the Transverse Mercator Projection. The revision process continued until recently, with new editions appearing every 10 years or so for urban areas.

Map Name(s) and Date(s)

010SE	1900	1:10,560
015NE	1900	1:10,560

Historical Map - Slice A

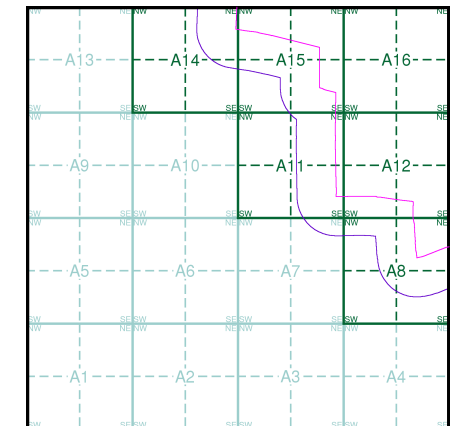

Order Details

Order Number: 298001706_1_1
 Customer Ref: 21-2098.04
 National Grid Reference: 480860, 381630
 Slice: A
 Site Area (Ha): 1355.61
 Search Buffer (m): 250

Site Details

West Barton 2



Tel: 0844 844 9952
 Fax: 0844 844 9951
 Web: [REDACTED]

Lincolnshire

Published 1921 - 1922

Source map scale - 1:10,560

The historical maps shown were reproduced from maps predominantly held at the scale adopted for England, Wales and Scotland in the 1840's. In 1854 the 1:2,500 scale was adopted for mapping urban areas; these maps were used to update the 1:10,560 maps. The published date given therefore is often some years later than the surveyed date. Before 1938, all OS maps were based on the Cassini Projection, with independent surveys of a single county or group of counties, giving rise to significant inaccuracies in outlying areas. In the late 1940's, a Provisional Edition was produced, which updated the 1:10,560 mapping from a number of sources. The maps appear unfinished - with all military camps and other strategic sites removed. These maps were initially overprinted with the National Grid. In 1970, the first 1:10,000 maps were produced using the Transverse Mercator Projection. The revision process continued until recently, with new editions appearing every 10 years or so for urban areas.

Map Name(s) and Date(s)

050SE	1922	1:10,560
059NE	1921	1:10,560

Historical Map - Slice A

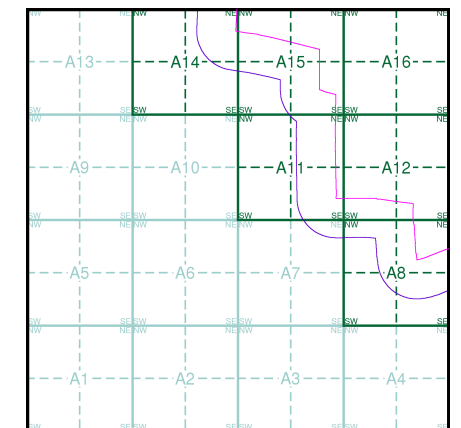

Order Details

Order Number: 298001706_1_1
 Customer Ref: 21-2098.04
 National Grid Reference: 480860, 381630
 Slice: A
 Site Area (Ha): 1355.61
 Search Buffer (m): 250

Site Details

West Barton 2

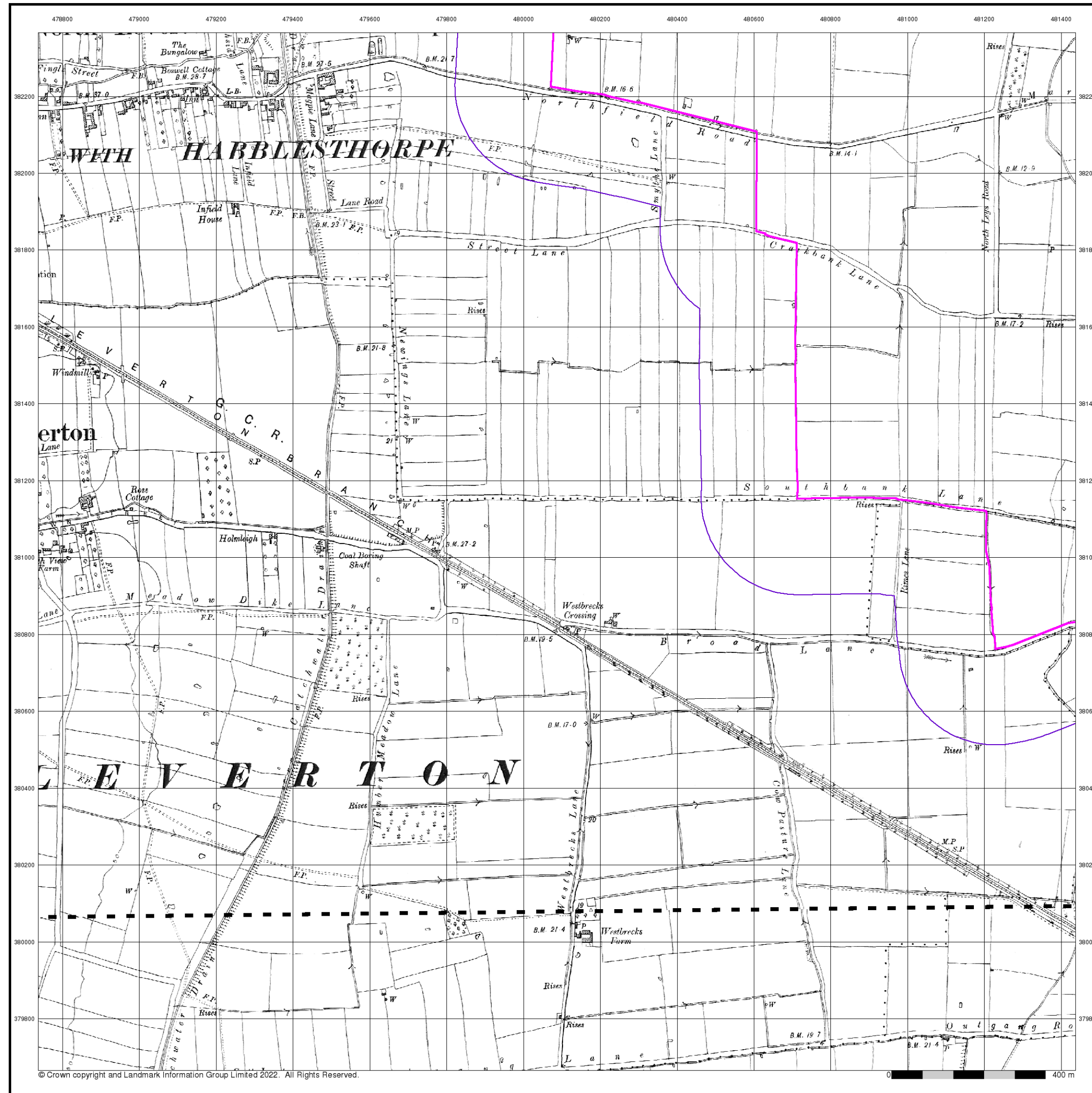

Lincolnshire
Published 1947

Source map scale - 1:10,560

The historical maps shown were reproduced from maps predominantly held at the scale adopted for England, Wales and Scotland in the 1840's. In 1854 the 1:2,500 scale was adopted for mapping urban areas; these maps were used to update the 1:10,560 maps. The published date given therefore is often some years later than the surveyed date. Before 1938, all OS maps were based on the Cassini Projection, with independent surveys of a single county or group of counties, giving rise to significant inaccuracies in outlying areas. In the late 1940's, a Provisional Edition was produced, which updated the 1:10,560 mapping from a number of sources. The maps appear unfinished - with all military camps and other strategic sites removed. These maps were initially overprinted with the National Grid. In 1970, the first 1:10,000 maps were produced using the Transverse Mercator Projection. The revision process continued until recently, with new editions appearing every 10 years or so for urban areas.

Map Name(s) and Date(s)

050SE	1947	1:10,560
059NE	1947	1:10,560

Historical Map - Slice A

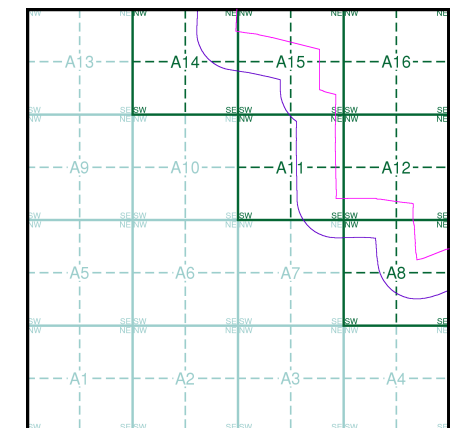

Order Details

Order Number: 298001706_1_1
 Customer Ref: 21-2098.04
 National Grid Reference: 480860, 381630
 Slice: A
 Site Area (Ha): 1355.61
 Search Buffer (m): 250

Site Details

West Barton 2

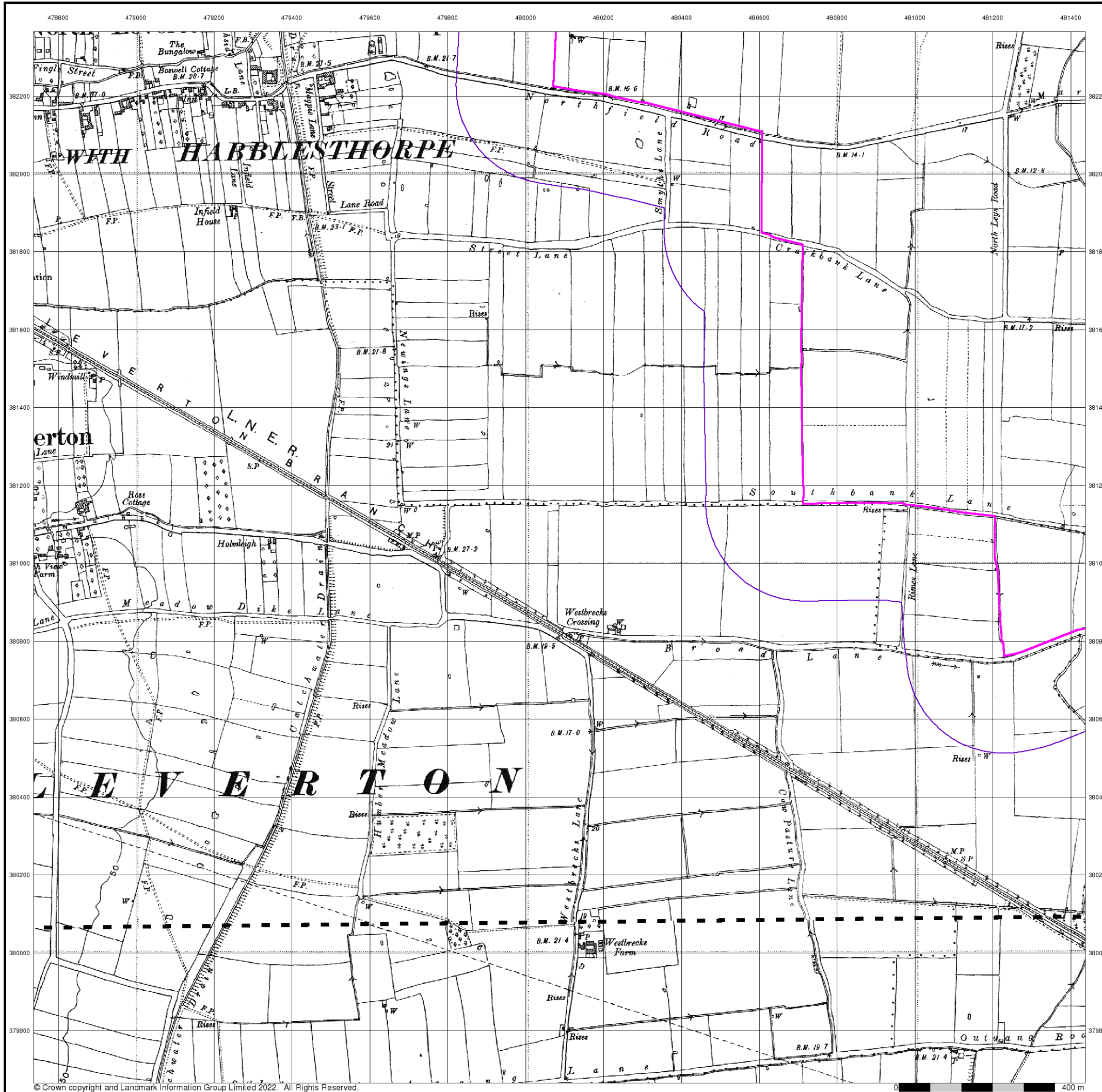

Ordnance Survey Plan

Published 1956

Source map scale - 1:10,000

The historical maps shown were reproduced from maps predominantly held at the scale adopted for England, Wales and Scotland in the 1840's. In 1854 the 1:2,500 scale was adopted for mapping urban areas; these maps were used to update the 1:10,560 maps. The published date given therefore is often some years later than the surveyed date. Before 1938, all OS maps were based on the Cassini Projection, with independent surveys of a single county or group of counties, giving rise to significant inaccuracies in outlying areas. In the late 1940's, a Provisional Edition was produced, which updated the 1:10,560 mapping from a number of sources. The maps appear unfinished - with all military camps and other strategic sites removed. These maps were initially overprinted with the National Grid. In 1970, the first 1:10,000 maps were produced using the Transverse Mercator Projection. The revision process continued until recently, with new editions appearing every 10 years or so for urban areas.

Map Name(s) and Date(s)

SK78SE	SK88SW
1956	1956
1:10,560	1:10,560
SK77NE	SK87NW
1956	1956
1:10,560	1:10,560

Historical Map - Slice A

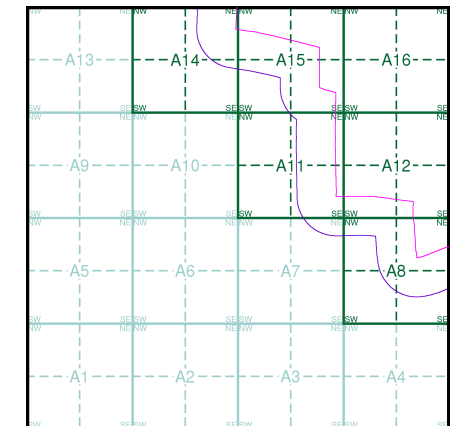

Order Details

Order Number: 298001706_1_1
 Customer Ref: 21-2098.04
 National Grid Reference: 480860, 381630
 Slice: A
 Site Area (Ha): 1355.61
 Search Buffer (m): 250

Site Details

West Barton 2

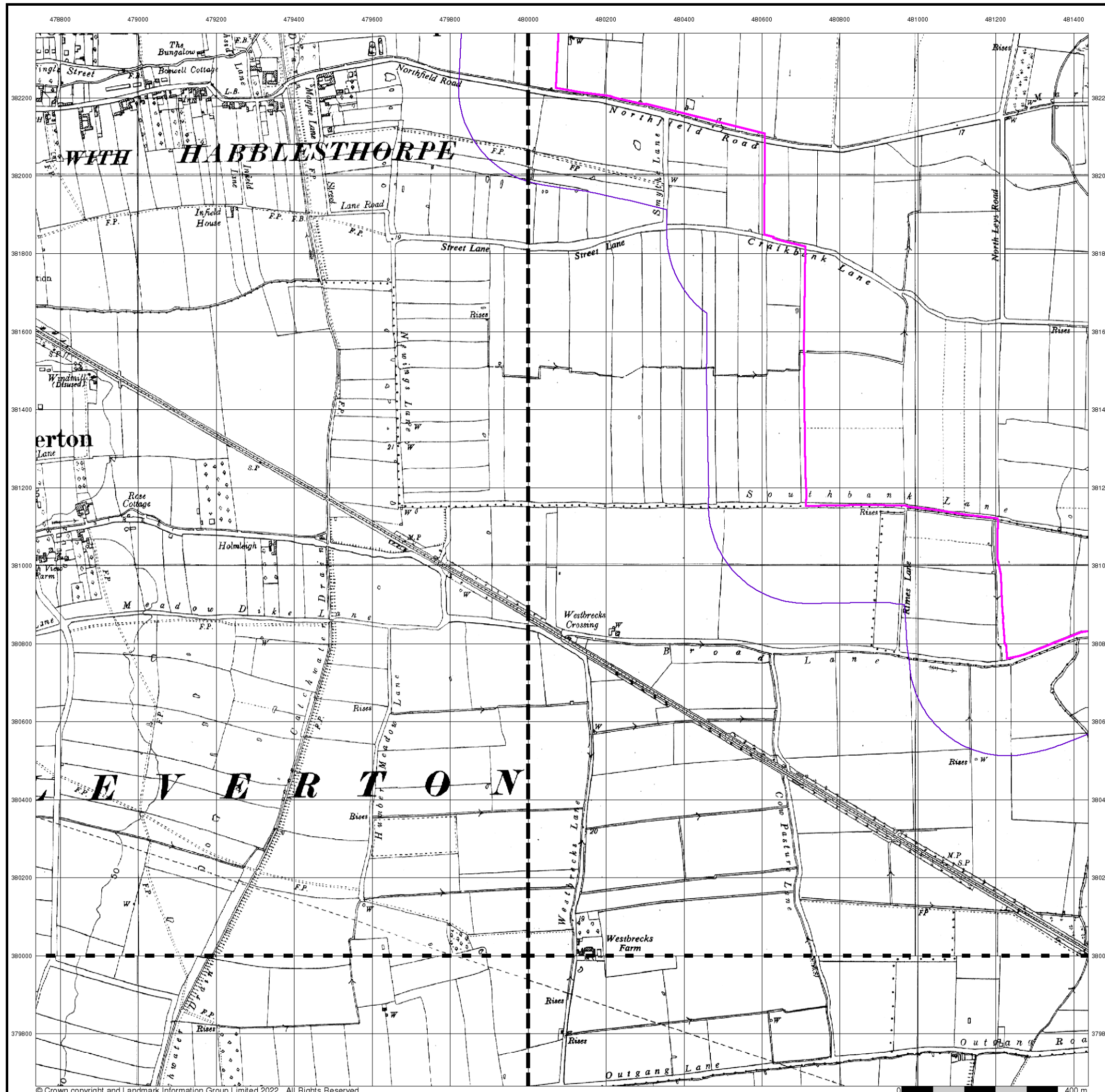

Ordnance Survey Plan

Published 1956

Source map scale - 1:10,000

The historical maps shown were reproduced from maps predominantly held at the scale adopted for England, Wales and Scotland in the 1840's. In 1854 the 1:2,500 scale was adopted for mapping urban areas; these maps were used to update the 1:10,560 maps. The published date given therefore is often some years later than the surveyed date. Before 1938, all OS maps were based on the Cassini Projection, with independent surveys of a single county or group of counties, giving rise to significant inaccuracies in outlying areas. In the late 1940's, a Provisional Edition was produced, which updated the 1:10,560 mapping from a number of sources. The maps appear unfinished - with all military camps and other strategic sites removed. These maps were initially overprinted with the National Grid. In 1970, the first 1:10,000 maps were produced using the Transverse Mercator Projection. The revision process continued until recently, with new editions appearing every 10 years or so for urban areas.

Map Name(s) and Date(s)

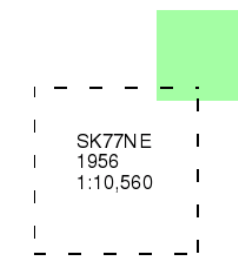

Historical Map - Slice A

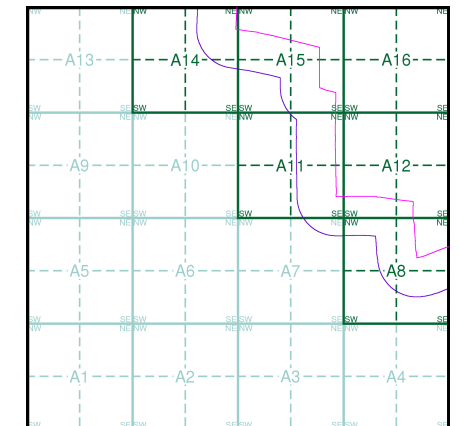

Order Details

Order Number: 298001706_1_1
 Customer Ref: 21-2098.04
 National Grid Reference: 480860, 381630
 Slice: A
 Site Area (Ha): 1355.61
 Search Buffer (m): 250

Site Details

West Barton 2

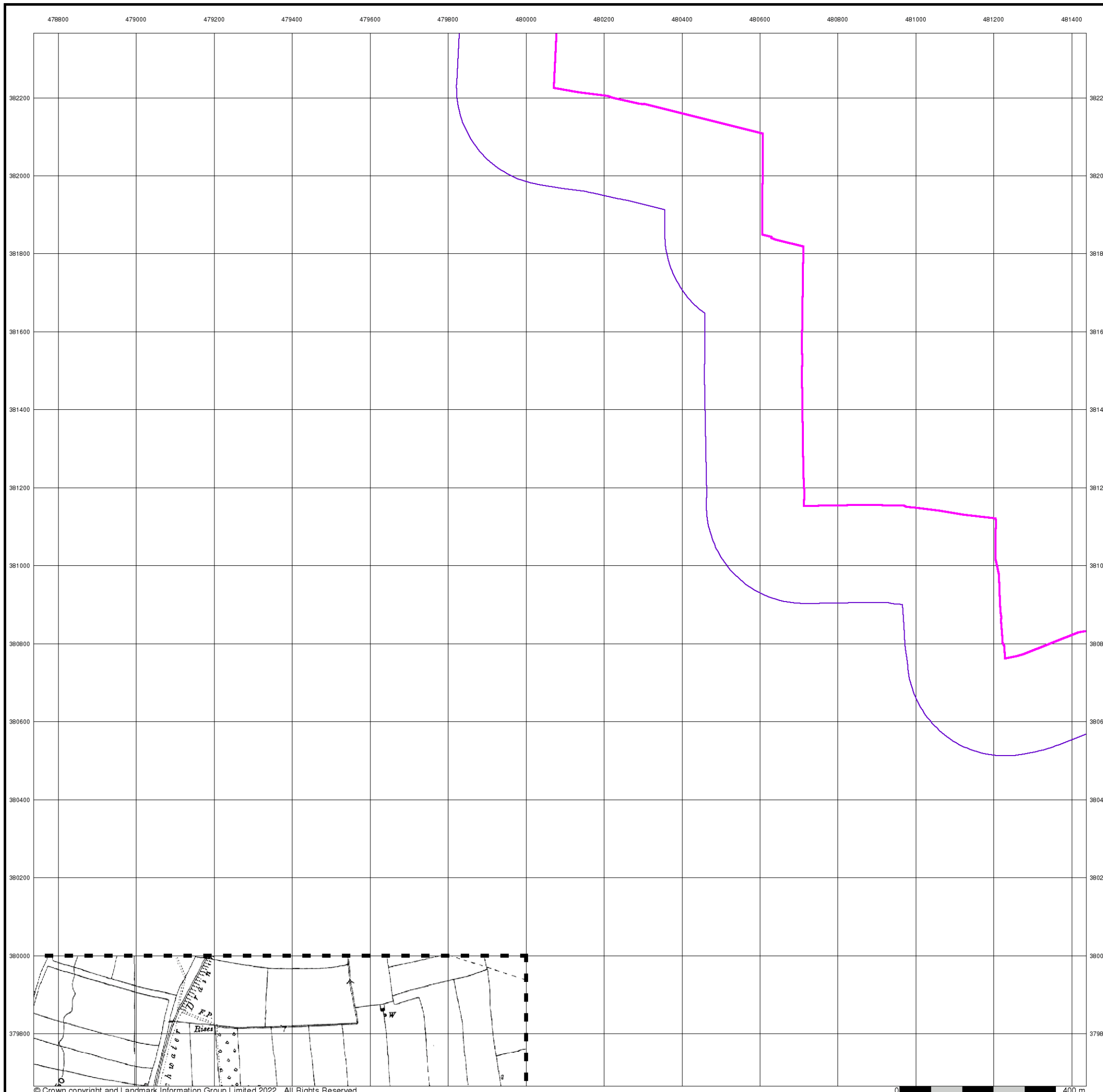



© Crown copyright and Landmark Information Group Limited 2022. All Rights Reserved.



Ordnance Survey Plan
Published 1974 - 1979
Source map scale - 1:10,000

The historical maps shown were reproduced from maps predominantly held at the scale adopted for England, Wales and Scotland in the 1840's. In 1854 the 1:2,500 scale was adopted for mapping urban areas; these maps were used to update the 1:10,560 maps. The published date given therefore is often some years later than the surveyed date. Before 1938, all OS maps were based on the Cassini Projection, with independent surveys of a single county or group of counties, giving rise to significant inaccuracies in outlying areas. In the late 1940's, a Provisional Edition was produced, which updated the 1:10,560 mapping from a number of sources. The maps appear unfinished - with all military camps and other strategic sites removed. These maps were initially overprinted with the National Grid. In 1970, the first 1:10,000 maps were produced using the Transverse Mercator Projection. The revision process continued until recently, with new editions appearing every 10 years or so for urban areas.

Map Name(s) and Date(s)

SK78SE	1979	1:10,000	
SK77NE	1978	1:10,000	
SK87NW	1974	1:10,560	

Historical Map - Slice A

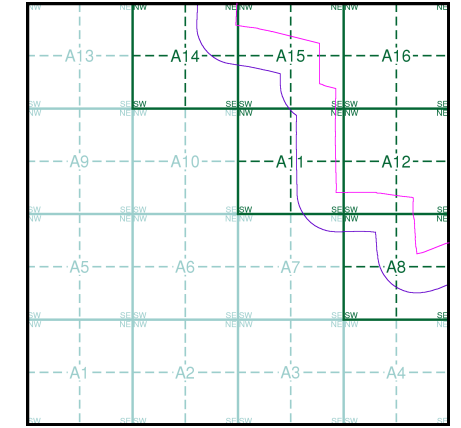

Order Details

Order Number: 298001706_1_1
 Customer Ref: 21-2098.04
 National Grid Reference: 480860, 381630
 Slice: A
 Site Area (Ha): 1355.61
 Search Buffer (m): 250

Site Details

West Barton 2



Tel: 0844 844 9952
 Fax: 0844 844 9951
 Web: [REDACTED]

Ordnance Survey Plan

Published 1980

Source map scale - 1:10,000

The historical maps shown were reproduced from maps predominantly held at the scale adopted for England, Wales and Scotland in the 1840's. In 1854 the 1:2,500 scale was adopted for mapping urban areas; these maps were used to update the 1:10,560 maps. The published date given therefore is often some years later than the surveyed date. Before 1938, all OS maps were based on the Cassini Projection, with independent surveys of a single county or group of counties, giving rise to significant inaccuracies in outlying areas. In the late 1940's, a Provisional Edition was produced, which updated the 1:10,560 mapping from a number of sources. The maps appear unfinished - with all military camps and other strategic sites removed. These maps were initially overprinted with the National Grid. In 1970, the first 1:10,000 maps were produced using the Transverse Mercator Projection. The revision process continued until recently, with new editions appearing every 10 years or so for urban areas.

Map Name(s) and Date(s)

- SK88SW
1980
1:10,000
- SK87NW
1980
1:10,000

Historical Map - Slice A

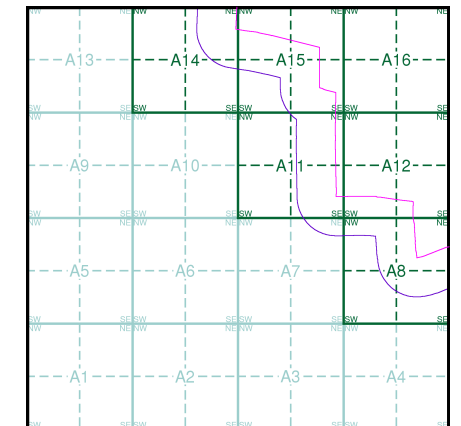

Order Details

Order Number: 298001706_1_1
 Customer Ref: 21-2098.04
 National Grid Reference: 480860, 381630
 Slice: A
 Site Area (Ha): 1355.61
 Search Buffer (m): 250

Site Details

West Barton 2



10k Raster Mapping

Published 2000

Source map scale - 1:10,000

The historical maps shown were produced from the Ordnance Survey's 1:10,000 colour raster mapping. These maps are derived from Landplan which replaced the old 1:10,000 maps originally published in 1970. The data is highly detailed showing buildings, fences and field boundaries as well as all roads, tracks and paths. Road names are also included together with the relevant road number and classification. Boundary information depiction includes county, unitary authority, district, civil parish and constituency.

Map Name(s) and Date(s)

SK78SE 2000 1:10,000	SK88SW 2000 1:10,000
SK77NE 2000 1:10,000	SK87NW 2000 1:10,000

Historical Map - Slice A

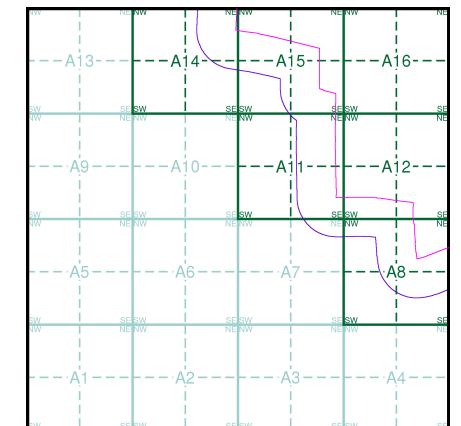

Order Details

Order Number: 298001706_1_1
 Customer Ref: 21-2098.04
 National Grid Reference: 480860, 381630
 Slice: A
 Site Area (Ha): 1355.61
 Search Buffer (m): 250

Site Details

West Barton 2

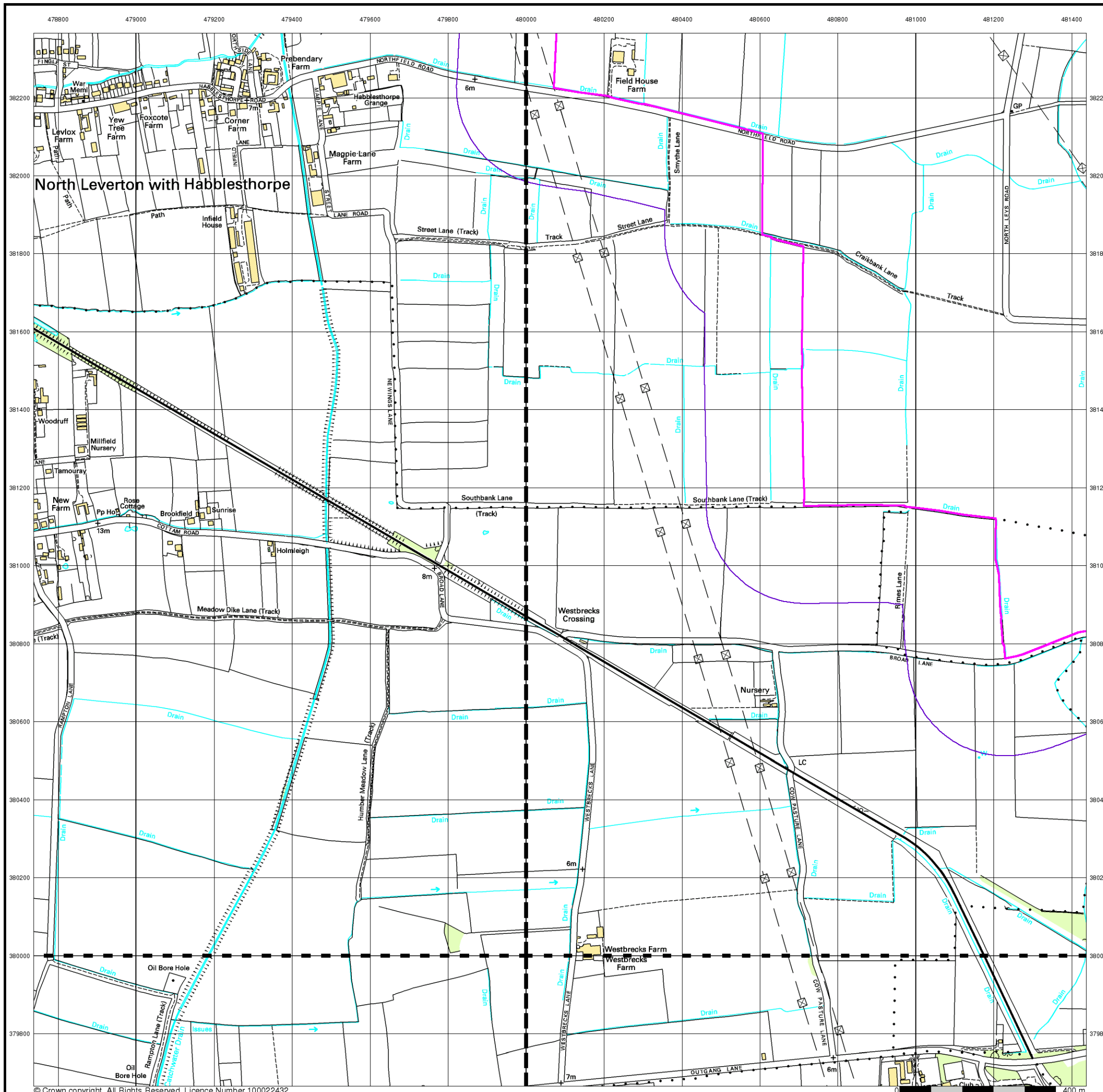

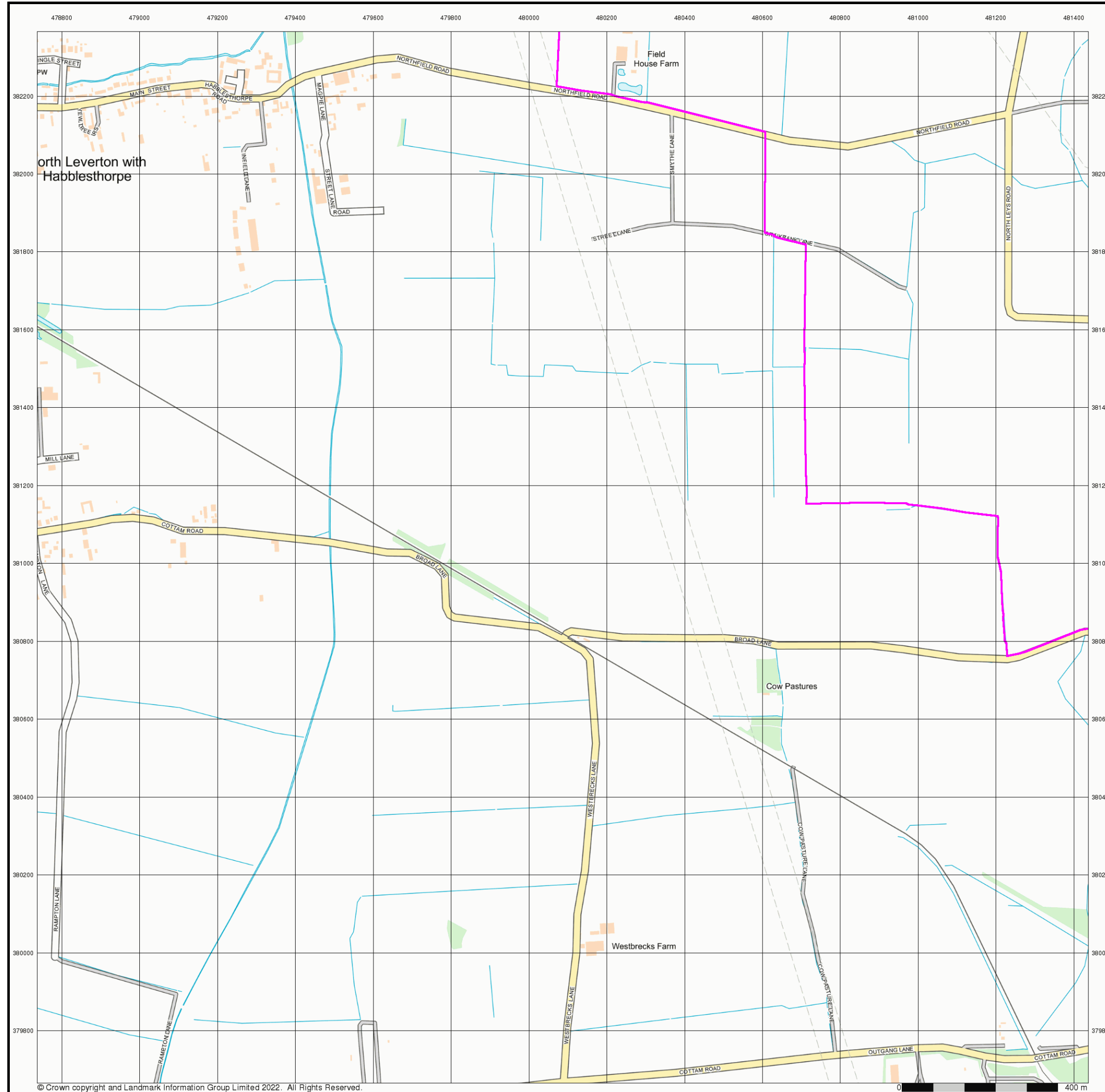

© Crown copyright and Landmark Information Group Limited 2022. All Rights Reserved.



Street View

Published 2022

Source map scale - 1:10,000

Street View is a street-level map for the whole of Great Britain produced by the Ordnance Survey. These maps are provided at a nominal scale of 1:10,000

Map Name(s) and Date(s)



Street View Map - Slice A

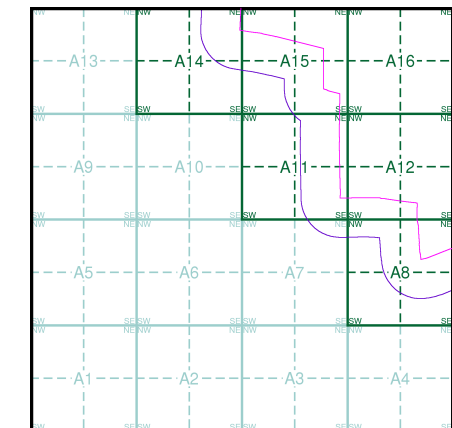

Order Details

Order Number: 298001706_1_1
 Customer Ref: 21-2098.04
 National Grid Reference: 480860, 381630
 Slice: A
 Site Area (Ha): 1355.61
 Search Buffer (m): 250

Site Details

West Barton 2



Tel: 0844 844 9952
 Fax: 0844 844 9951
 Web: [REDACTED]

Historical Mapping Legends

Ordnance Survey County Series and Ordnance Survey Plan 1:2,500

Quarry **Gravel Pit** **Sand Pit**
Clay Pit **Shingle** **Refuse Heap**
Sloping Masonry **Flat Rock**
Marsh **Reeds** **Osiers**
Rough Pasture **Furze** **Wood**
Mixed Wood **Brushwood** **Orchard**
Fir **Ford** **Stepping Stones**
Ferry **Waterfall** **Lock**
Trig. Station **Altitude at Trig. Station**
B.M. 325.9 **Bench Mark** **Surface Level**
Arrow denotes flow of water **Antiquities (site of)**
Cutting **Embankment**
Railway crossing Road **Level Crossing** **Road crossing Railway**
Railway crossing River or Canal **Road over single stream** **Road over River or Canal**
County Boundary (Geographical)
County & Civil Parish Boundary
Administrative County & Civil Parish Boundary
County Borough Boundary (England)
Co. Boro. Bdy.
County Burgh Boundary (Scotland)
Co. Burgh Bdy.
BP BS Boundary Post or Stone **P.C.B** Police Call Box
B.R. Bridle Road **P** Pump
E.P Electricity Pylon **S.P** Signal Post
F.B. Foot Bridge **SL** Sluice
F.P. Foot Path **Sp.** Spring
G.P Guide Post or Board **T.C.B** Telephone Call Box
M.S Mile Stone **Tr.** Trough
M.P M.R Mooring Post or Ring **W** Well

Ordnance Survey Plan, Additional SIMs and Supply of Unpublished Survey Information 1:2,500 and 1:1,250

Inactive Quarry, Chalk Pit or Clay Pit **Active Quarry, Chalk Pit or Clay Pit**
Rock **Boulders**
Cliff **Slopes** **Top**
Roofed Building **Glazed Roof Building**
Sloping Masonry **Archway**
Non-Coniferous Tree (surveyed) **Coniferous Tree (surveyed)**
Non-Coniferous Trees (not surveyed) **Coniferous Trees (not surveyed)**
Orchard Tree **Scrub** **Bracken**
Coppice, Osier **Reeds** **Marsh, Saltings**
Rough Grassland **Heath** **Culvert**
Direction of water flow **Bench Mark** **Antiquity (site of)**
Cave Entrance **Triangulation Station** **Electricity Pylon**
Electricity Transmission Line
County Boundary (Geographical)
County & Civil Parish Boundary
Civil Parish Boundary
Admin. County or County Bor. Boundary
London Borough Boundary
Symbol marking point where boundary mereing changes
BH Beer House **P** Pillar, Pole or Post
BP, BS Boundary Post or Stone **PO** Post Office
Cn, C Capstan, Crane **PC** Public Convenience
Chy Chimney **PH** Public House
D Fn Drinking Fountain **Pp** Pump
EI P Electricity Pillar or Post **SB, S Br** Signal Box or Bridge
FAP Fire Alarm Pillar **SP, SL** Signal Post or Light
FB Foot Bridge **Spr** Spring
GP Guide Post **Tk** Tank or Track
H Hydrant or Hydraulic **TCB** Telephone Call Box
LC Level Crossing **TCP** Telephone Call Post
MH Manhole **Tr** Trough
MP Mile Post or Mooring Post **Wr Pt, Wr T** Water Point, Water Tap
MS Mile Stone **W** Well
NTL Normal Tidal Limit **Wd Pp** Wind Pump

Large-Scale National Grid Data 1:2,500 and 1:1,250

Cliff **Slopes** **Top**
Rock **Rock (scattered)**
Boulders **Boulders (scattered)**
Positioned Boulder **Scree**
Non-Coniferous Tree (surveyed) **Coniferous Tree (surveyed)**
Non-Coniferous Trees (not surveyed) **Coniferous Trees (not surveyed)**
Orchard Tree **Scrub** **Bracken**
Coppice, Osier **Reeds** **Marsh, Saltings**
Rough Grassland **Heath** **Culvert**
Direction of water flow **Triangulation Station** **Antiquity (site of)**
Electricity Transmission Line **Electricity Pylon**
B.M. 231.60m Bench Mark **Buildings with Building Seed**
Roofed Building **Glazed Roof Building**
Civil parish/community boundary
District boundary
County boundary
Boundary post/stone
Boundary mereing symbol (note: these always appear in opposed pairs or groups of three)
Bks Barracks **P** Pillar, Pole or Post
Bty Battery **PO** Post Office
Cemy Cemetery **PC** Public Convenience
Chy Chimney **Pp** Pump
Cis Cistern **Ppg Sta** Pumping Station
Dismtd Rly Dismantled Railway **PW** Place of Worship
EI Gen Sta Electricity Generating Station **Sewage Ppg Sta** Sewage Pumping Station
EI P Electricity Pole, Pillar **SB, S Br** Signal Box or Bridge
EI Sub Sta Electricity Sub Station **SP, SL** Signal Post or Light
FB Filter Bed **Spr** Spring
Fn / D Fn Fountain / Drinking Ftn. **Tk** Tank or Track
Gas Gov Gas Valve Compound **Tr** Trough
GVC Gas Governor **Wd Pp** Wind Pump
GP Guide Post **Wr Pt, Wr T** Water Point, Water Tap
MH Manhole **Wks** Works (building or area)
MP, MS Mile Post or Mile Stone **W** Well

Historical Mapping & Photography included:

Mapping Type	Scale	Date	Pg
Nottinghamshire	1:2,500	1886	2
Nottinghamshire	1:2,500	1899	3
Nottinghamshire	1:2,500	1920	4
Ordnance Survey Plan	1:2,500	1974	5
Large-Scale National Grid Data	1:2,500	1994	6

Historical Map - Segment A8

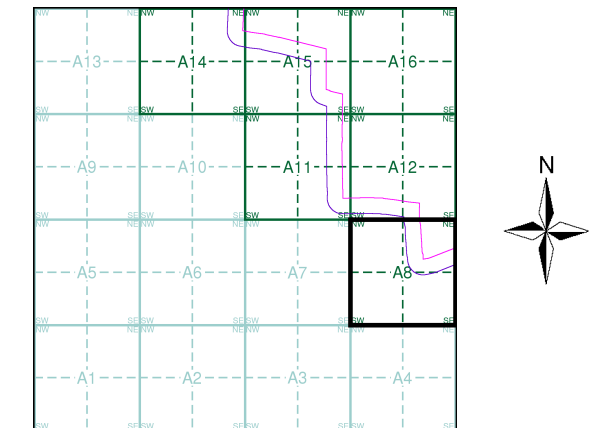

Order Details

Order Number: 298001706_1_1
 Customer Ref: 21-2098.04
 National Grid Reference: 480860, 381630
 Slice: A
 Site Area (Ha): 1355.61
 Search Buffer (m): 100

Site Details

West Barton 2

Nottinghamshire

Published 1886

Source map scale - 1:2,500

The historical maps shown were reproduced from maps predominantly held at the scale adopted for England, Wales and Scotland in the 1840's. In 1854 the 1:2,500 scale was adopted for mapping urban areas and by 1896 it covered the whole of what were considered to be the cultivated parts of Great Britain. The published date given below is often some years later than the surveyed date. Before 1938, all OS maps were based on the Cassini Projection, with independent surveys of a single county or group of counties, giving rise to significant inaccuracies in outlying areas.

Map Name(s) and Date(s)

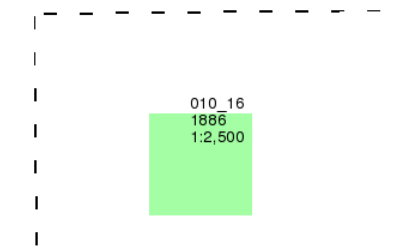

Historical Map - Segment A8

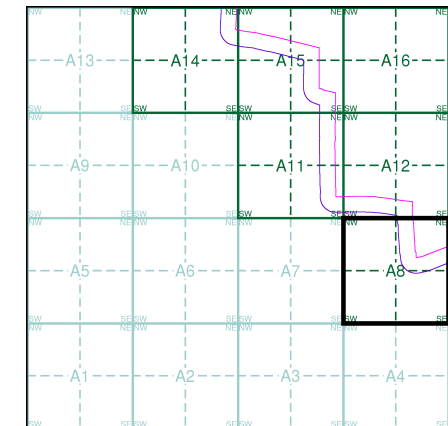

Order Details

Order Number: 298001706_1_1
 Customer Ref: 21-2098.04
 National Grid Reference: 480860, 381630
 Slice: A
 Site Area (Ha): 1355.61
 Search Buffer (m): 100

Site Details

West Barton 2

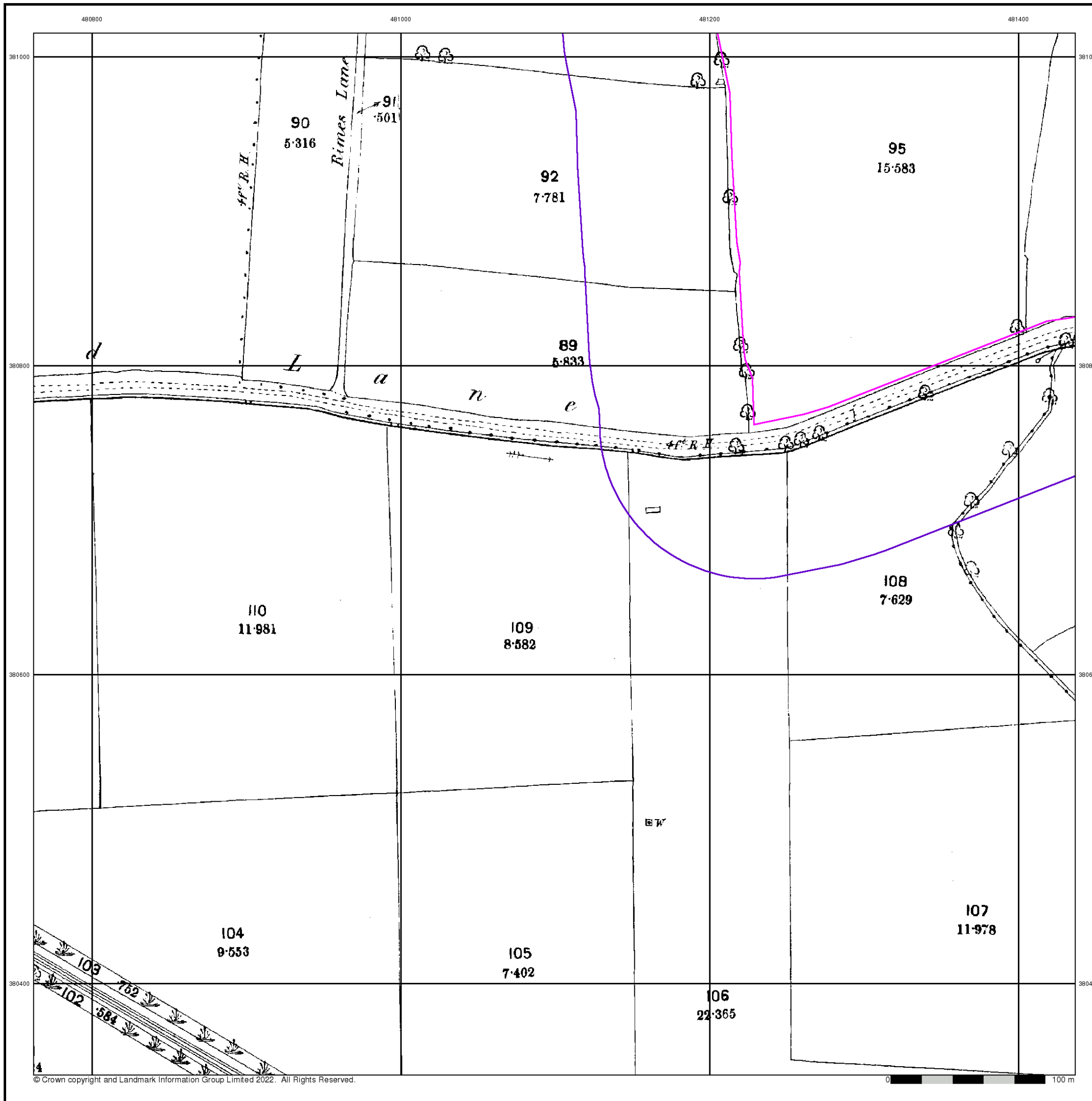

Nottinghamshire

Published 1899

Source map scale - 1:2,500

The historical maps shown were reproduced from maps predominantly held at the scale adopted for England, Wales and Scotland in the 1840's. In 1854 the 1:2,500 scale was adopted for mapping urban areas and by 1896 it covered the whole of what were considered to be the cultivated parts of Great Britain. The published date given below is often some years later than the surveyed date. Before 1938, all OS maps were based on the Cassini Projection, with independent surveys of a single county or group of counties, giving rise to significant inaccuracies in outlying areas.

Map Name(s) and Date(s)

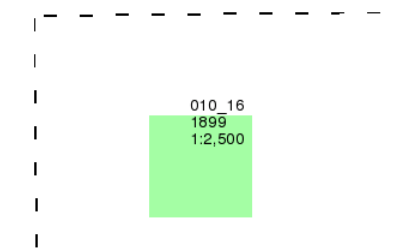

Historical Map - Segment A8

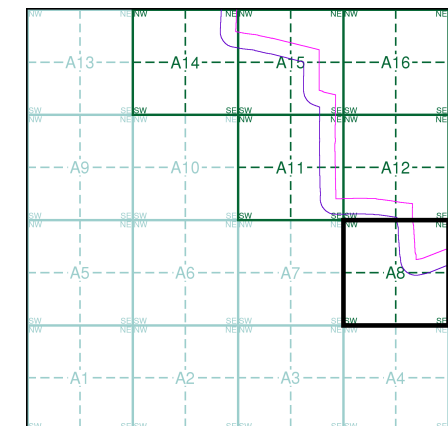

Order Details

Order Number: 298001706_1_1
 Customer Ref: 21-2098.04
 National Grid Reference: 480860, 381630
 Slice: A
 Site Area (Ha): 1355.61
 Search Buffer (m): 100

Site Details

West Barton 2



Nottinghamshire

Published 1920

Source map scale - 1:2,500

The historical maps shown were reproduced from maps predominantly held at the scale adopted for England, Wales and Scotland in the 1840's. In 1854 the 1:2,500 scale was adopted for mapping urban areas and by 1896 it covered the whole of what were considered to be the cultivated parts of Great Britain. The published date given below is often some years later than the surveyed date. Before 1938, all OS maps were based on the Cassini Projection, with independent surveys of a single county or group of counties, giving rise to significant inaccuracies in outlying areas.

Map Name(s) and Date(s)

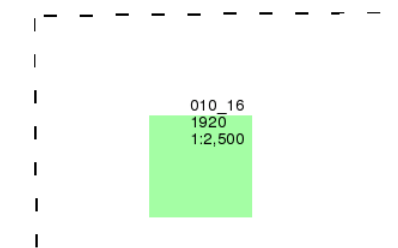

Historical Map - Segment A8

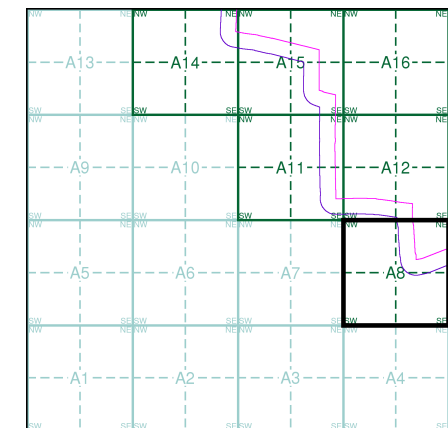

Order Details

Order Number: 298001706_1_1
 Customer Ref: 21-2098.04
 National Grid Reference: 480860, 381630
 Slice: A
 Site Area (Ha): 1355.61
 Search Buffer (m): 100

Site Details

West Barton 2



Ordnance Survey Plan
Published 1974
Source map scale - 1:2,500

The historical maps shown were reproduced from maps predominantly held at the scale adopted for England, Wales and Scotland in the 1840's. In 1854 the 1:2,500 scale was adopted for mapping urban areas and by 1896 it covered the whole of what were considered to be the cultivated parts of Great Britain. The published date given below is often some years later than the surveyed date. Before 1938, all OS maps were based on the Cassini Projection, with independent surveys of a single county or group of counties, giving rise to significant inaccuracies in outlying areas.

Map Name(s) and Date(s)

SK8081 1974 1:2,500	SK8181 1974 1:2,500
SK8080 1974 1:2,500	SK8180 1974 1:2,500

Historical Map - Segment A8

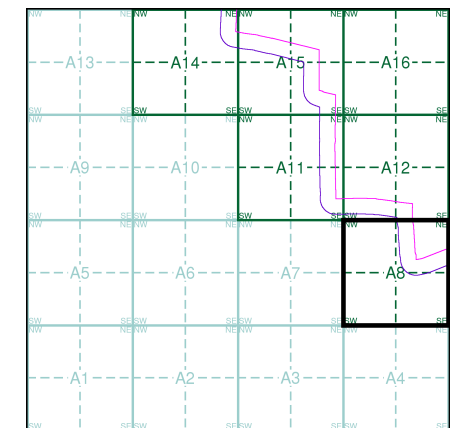

Order Details

Order Number: 298001706_1_1
 Customer Ref: 21-2098.04
 National Grid Reference: 480860, 381630
 Slice: A
 Site Area (Ha): 1355.61
 Search Buffer (m): 100

Site Details

West Barton 2

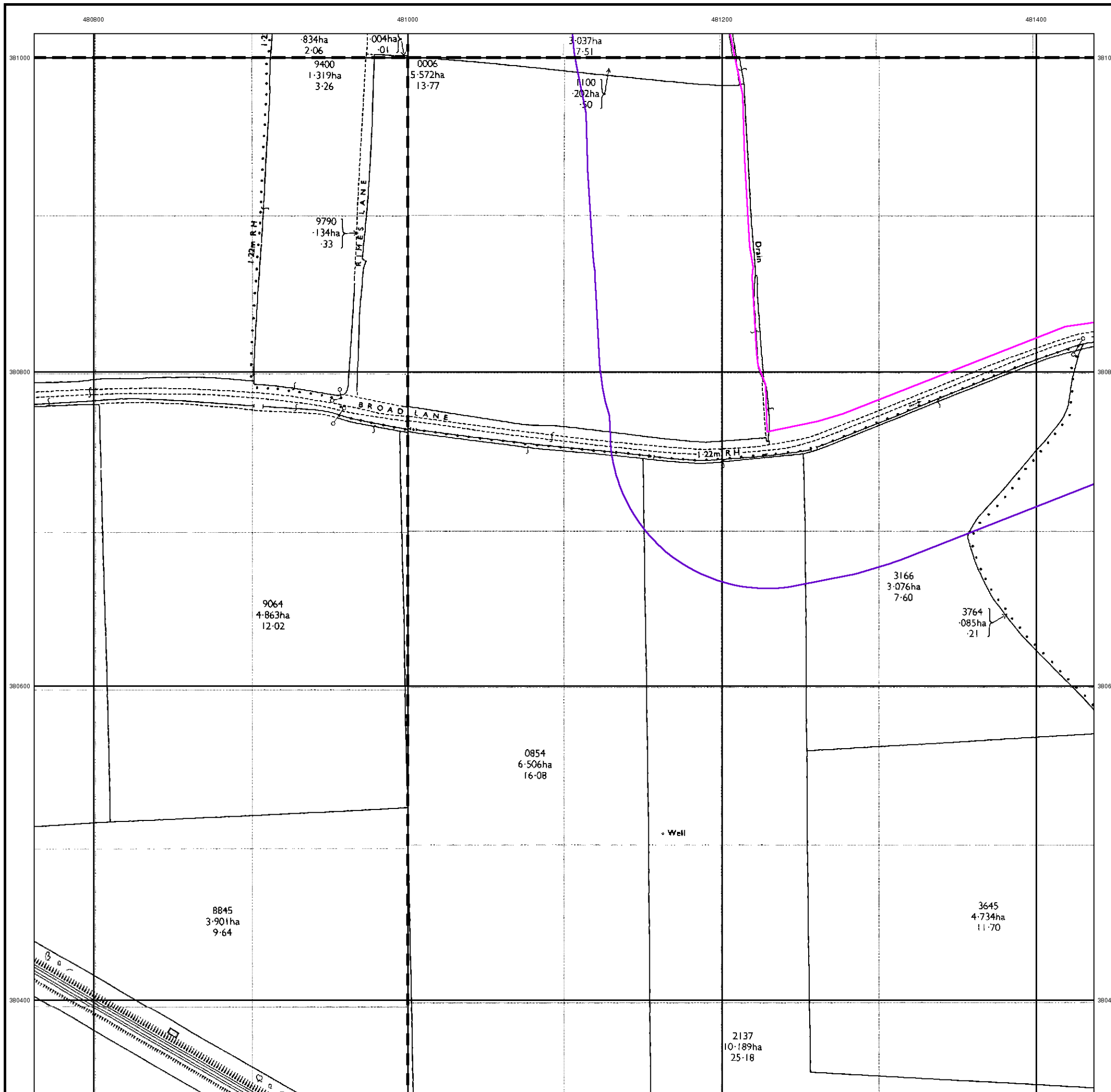

Large-Scale National Grid Data

Published 1994

Source map scale - 1:2,500

'Large Scale National Grid Data' superseded SIM cards (Ordnance Survey's 'Survey of Information on Microfilm') in 1992, and continued to be produced until 1999. These maps were the fore-runners of digital mapping and so provide detailed information on houses and roads, but tend to show less topographic features such as vegetation. These maps were produced at both 1:2,500 and 1:1,250 scales.

Map Name(s) and Date(s)

SK8081 1994 1:2,500	SK8181 1994 1:2,500
SK8080 1994 1:2,500	SK8180 1994 1:2,500

Historical Map - Segment A8

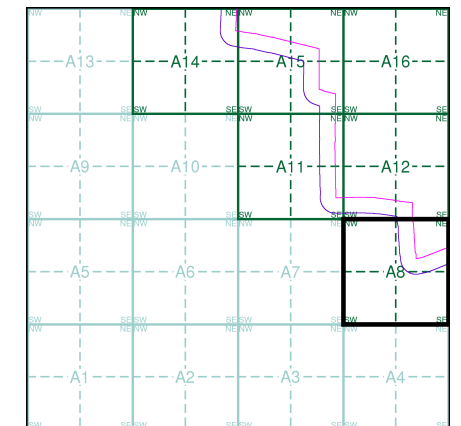

Order Details

Order Number: 298001706_1_1
 Customer Ref: 21-2098.04
 National Grid Reference: 480860, 381630
 Slice: A
 Site Area (Ha): 1355.61
 Search Buffer (m): 100

Site Details

West Barton 2

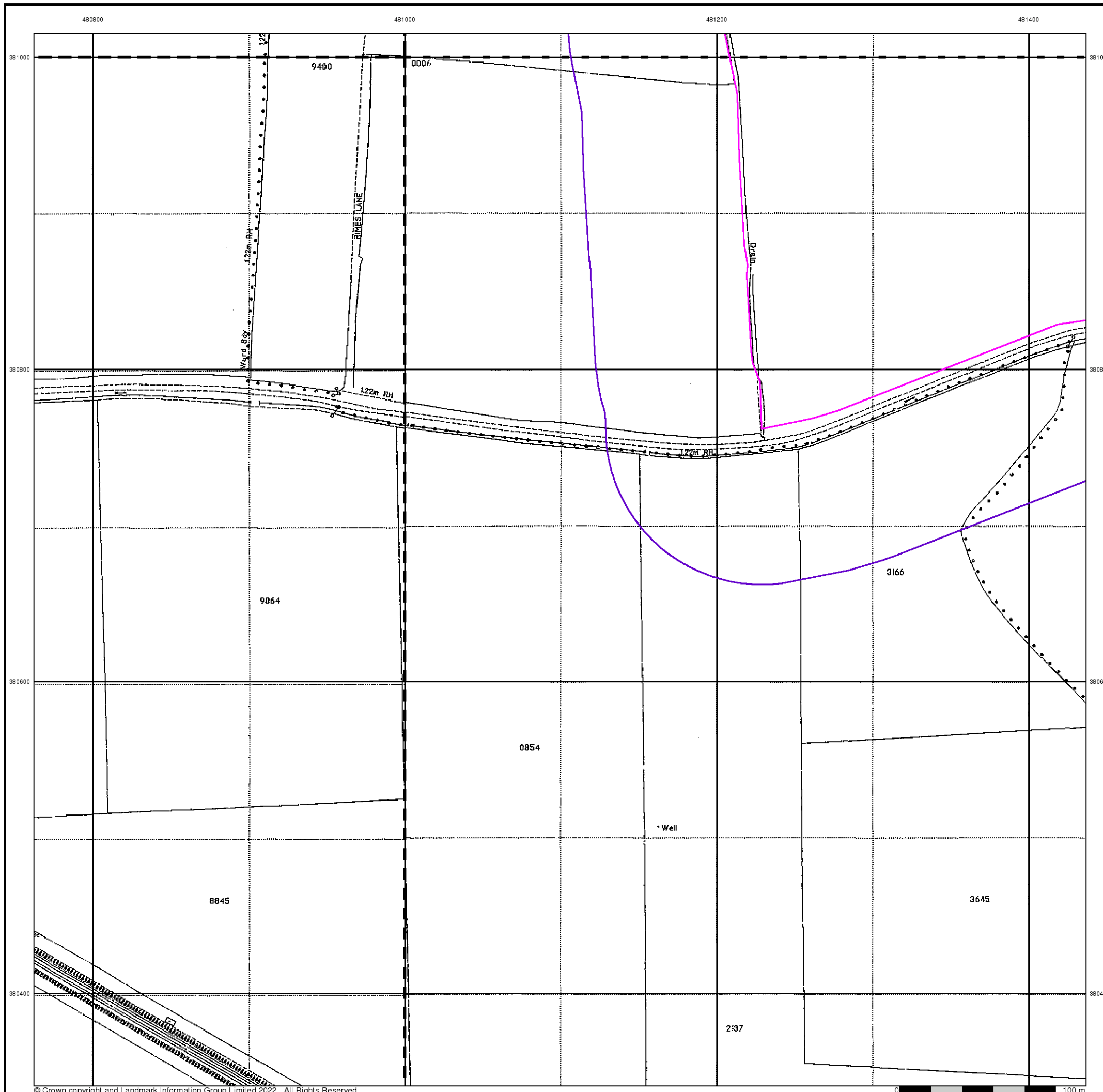

Historical Mapping Legends

Ordnance Survey County Series and Ordnance Survey Plan 1:2,500

Quarry **Gravel Pit** **Sand Pit**
Clay Pit **Shingle** **Refuse Heap**
Sloping Masonry **Flat Rock**
Marsh **Reeds** **Osiers**
Rough Pasture **Furze** **Wood**
Mixed Wood **Brushwood** **Orchard**
Fir **Ford** **Stepping Stones**
Ferry **Waterfall** **Lock**
Trig. Station **Altitude at Trig. Station**
B.M. 325.9 **Bench Mark** **Surface Level**
Arrow denotes flow of water **Antiquities (site of)**
Cutting **Embankment**
Railway crossing Road **Level Crossing** **Road crossing Railway**
Railway crossing River or Canal **Road over single stream** **Road over River or Canal**
County Boundary (Geographical)
County & Civil Parish Boundary
Administrative County & Civil Parish Boundary
County Borough Boundary (England)
Co. Boro. Bdy.
County Burgh Boundary (Scotland)
Co. Burgh Bdy.
BP BS Boundary Post or Stone **P.C.B** Police Call Box
B.R. Bridle Road **P** Pump
E.P Electricity Pylon **S.P** Signal Post
F.B. Foot Bridge **SL** Sluice
F.P. Foot Path **Sp.** Spring
G.P Guide Post or Board **T.C.B** Telephone Call Box
M.S Mile Stone **Tr.** Trough
M.P M.R Mooring Post or Ring **W** Well

Ordnance Survey Plan, Additional SIMs and Supply of Unpublished Survey Information 1:2,500 and 1:1,250

Inactive Quarry, Chalk Pit or Clay Pit **Active Quarry, Chalk Pit or Clay Pit**
Rock **Boulders**
Cliff **Slopes** **Top**
Roofed Building **Glazed Roof Building**
Sloping Masonry **Archway**
Non-Coniferous Tree (surveyed) **Coniferous Tree (surveyed)**
Non-Coniferous Trees (not surveyed) **Coniferous Trees (not surveyed)**
Orchard Tree **Scrub** **Bracken**
Coppice, Osier **Reeds** **Marsh, Saltings**
Rough Grassland **Heath** **Culvert**
Direction of water flow **Bench Mark** **Antiquity (site of)**
Cave Entrance **Triangulation Station** **Electricity Pylon**
Electricity Transmission Line
County Boundary (Geographical)
County & Civil Parish Boundary
Civil Parish Boundary
Admin. County or County Bor. Boundary
London Borough Boundary
Symbol marking point where boundary mereing changes
BH Beer House **P** Pillar, Pole or Post
BP, BS Boundary Post or Stone **PO** Post Office
Cn, C Capstan, Crane **PC** Public Convenience
Chy Chimney **PH** Public House
D Fn Drinking Fountain **Pp** Pump
EI P Electricity Pillar or Post **SB, S Br** Signal Box or Bridge
FAP Fire Alarm Pillar **SP, SL** Signal Post or Light
FB Foot Bridge **Spr** Spring
GP Guide Post **Tk** Tank or Track
H Hydrant or Hydraulic **TCB** Telephone Call Box
LC Level Crossing **TCP** Telephone Call Post
MH Manhole **Tr** Trough
MP Mile Post or Mooring Post **Wr Pt, Wr T** Water Point, Water Tap
MS Mile Stone **W** Well
NTL Normal Tidal Limit **Wd Pp** Wind Pump

Large-Scale National Grid Data 1:2,500 and 1:1,250

Cliff **Slopes** **Top**
Rock **Rock (scattered)**
Boulders **Boulders (scattered)**
Positioned Boulder **Scree**
Non-Coniferous Tree (surveyed) **Coniferous Tree (surveyed)**
Non-Coniferous Trees (not surveyed) **Coniferous Trees (not surveyed)**
Orchard Tree **Scrub** **Bracken**
Coppice, Osier **Reeds** **Marsh, Saltings**
Rough Grassland **Heath** **Culvert**
Direction of water flow **Triangulation Station** **Antiquity (site of)**
Electricity Transmission Line **Electricity Pylon**
BM 231.60m Bench Mark **Buildings with Building Seed**
Roofed Building **Glazed Roof Building**
Civil parish/community boundary
District boundary
County boundary
Boundary post/stone
Boundary mereing symbol (note: these always appear in opposed pairs or groups of three)
Bks Barracks **P** Pillar, Pole or Post
Bty Battery **PO** Post Office
Cemy Cemetery **PC** Public Convenience
Chy Chimney **Pp** Pump
Cis Cistern **Ppg Sta** Pumping Station
Dismtd Rly Dismantled Railway **PW** Place of Worship
EI Gen Sta Electricity Generating Station **Sewage Ppg Sta** Sewage Pumping Station
EI P Electricity Pole, Pillar **SB, S Br** Signal Box or Bridge
EI Sub Sta Electricity Sub Station **SP, SL** Signal Post or Light
FB Filter Bed **Spr** Spring
Fn / D Fn Fountain / Drinking Ftn. **Tk** Tank or Track
Gas Gov Gas Valve Compound **Tr** Trough
GVC Gas Governor **Wd Pp** Wind Pump
GP Guide Post **Wr Pt, Wr T** Water Point, Water Tap
MH Manhole **Wks** Works (building or area)
MP, MS Mile Post or Mile Stone **W** Well



Historical Mapping & Photography included:

Mapping Type	Scale	Date	Pg
Lincolnshire	1:2,500	1886	2
Nottinghamshire	1:2,500	1886	3
Nottinghamshire	1:2,500	1899	4
Nottinghamshire	1:2,500	1920	5
Lincolnshire	1:2,500	1920	6
Ordnance Survey Plan	1:2,500	1974	7
Large-Scale National Grid Data	1:2,500	1994	8

Historical Map - Segment A11

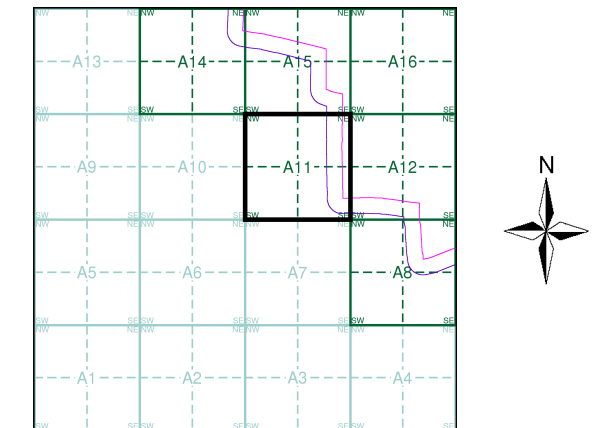

Order Details

Order Number: 298001706_1_1
 Customer Ref: 21-2098.04
 National Grid Reference: 480860, 381630
 Slice: A
 Site Area (Ha): 1355.61
 Search Buffer (m): 100

Site Details

West Barton 2



Tel: 0844 844 9952
 Fax: 0844 844 9951
 Web: [REDACTED]

Lincolnshire
Published 1886

Source map scale - 1:2,500

The historical maps shown were reproduced from maps predominantly held at the scale adopted for England, Wales and Scotland in the 1840's. In 1854 the 1:2,500 scale was adopted for mapping urban areas and by 1896 it covered the whole of what were considered to be the cultivated parts of Great Britain. The published date given below is often some years later than the surveyed date. Before 1938, all OS maps were based on the Cassini Projection, with independent surveys of a single county or group of counties, giving rise to significant inaccuracies in outlying areas.

Map Name(s) and Date(s)

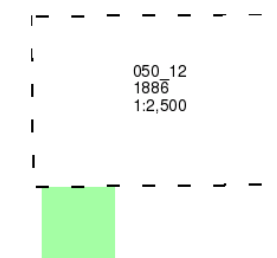

Historical Map - Segment A11

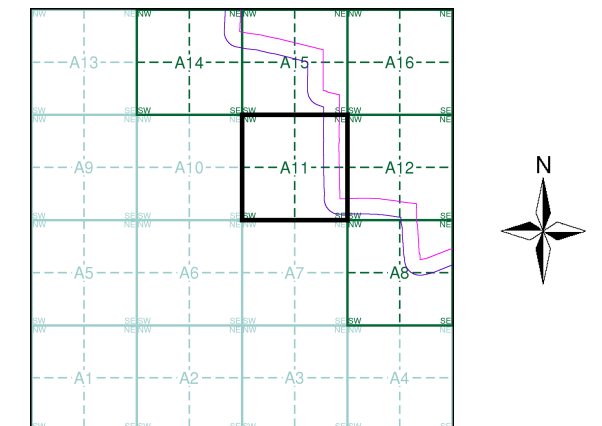

Order Details

Order Number: 298001706_1_1
 Customer Ref: 21-2098.04
 National Grid Reference: 480860, 381630
 Slice: A
 Site Area (Ha): 1355.61
 Search Buffer (m): 100

Site Details

West Barton 2

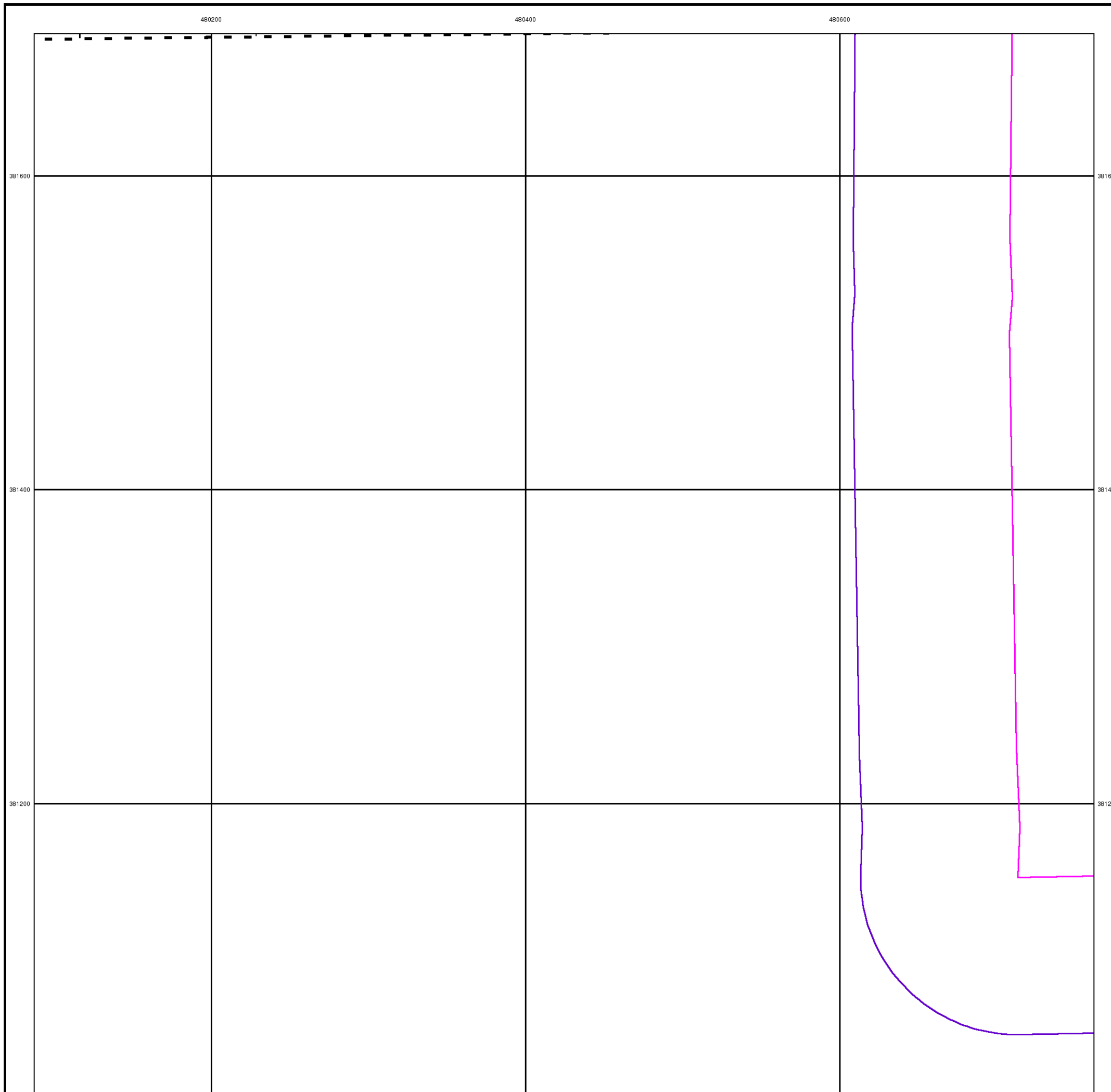

Nottinghamshire

Published 1886

Source map scale - 1:2,500

The historical maps shown were reproduced from maps predominantly held at the scale adopted for England, Wales and Scotland in the 1840's. In 1854 the 1:2,500 scale was adopted for mapping urban areas and by 1896 it covered the whole of what were considered to be the cultivated parts of Great Britain. The published date given below is often some years later than the surveyed date. Before 1938, all OS maps were based on the Cassini Projection, with independent surveys of a single county or group of counties, giving rise to significant inaccuracies in outlying areas.

Map Name(s) and Date(s)

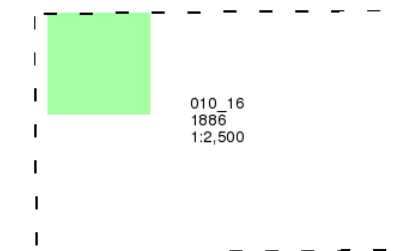

Historical Map - Segment A11

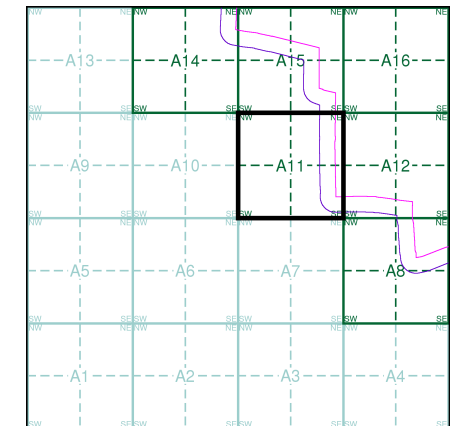

Order Details

Order Number: 298001706_1_1
 Customer Ref: 21-2098.04
 National Grid Reference: 480860, 381630
 Slice: A
 Site Area (Ha): 1355.61
 Search Buffer (m): 100

Site Details

West Barton 2

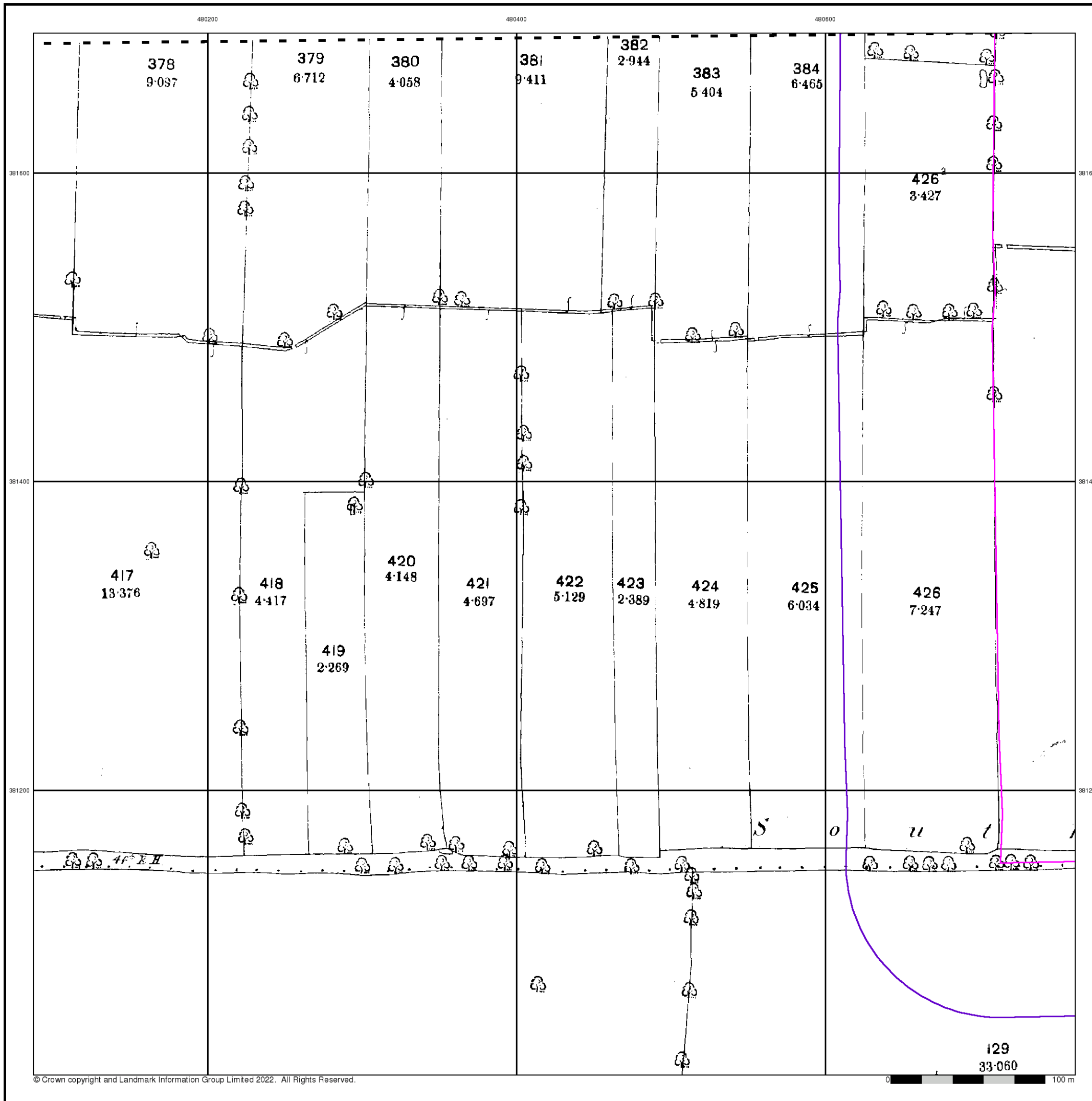

Nottinghamshire

Published 1899

Source map scale - 1:2,500

The historical maps shown were reproduced from maps predominantly held at the scale adopted for England, Wales and Scotland in the 1840's. In 1854 the 1:2,500 scale was adopted for mapping urban areas and by 1896 it covered the whole of what were considered to be the cultivated parts of Great Britain. The published date given below is often some years later than the surveyed date. Before 1938, all OS maps were based on the Cassini Projection, with independent surveys of a single county or group of counties, giving rise to significant inaccuracies in outlying areas.

Map Name(s) and Date(s)

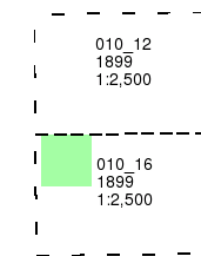

Historical Map - Segment A11

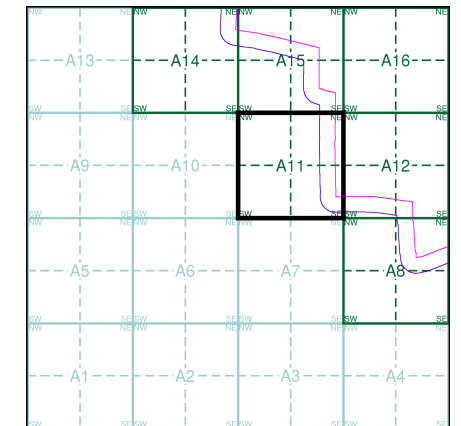

Order Details

Order Number: 298001706_1_1
 Customer Ref: 21-2098.04
 National Grid Reference: 480860, 381630
 Slice: A
 Site Area (Ha): 1355.61
 Search Buffer (m): 100

Site Details

West Barton 2

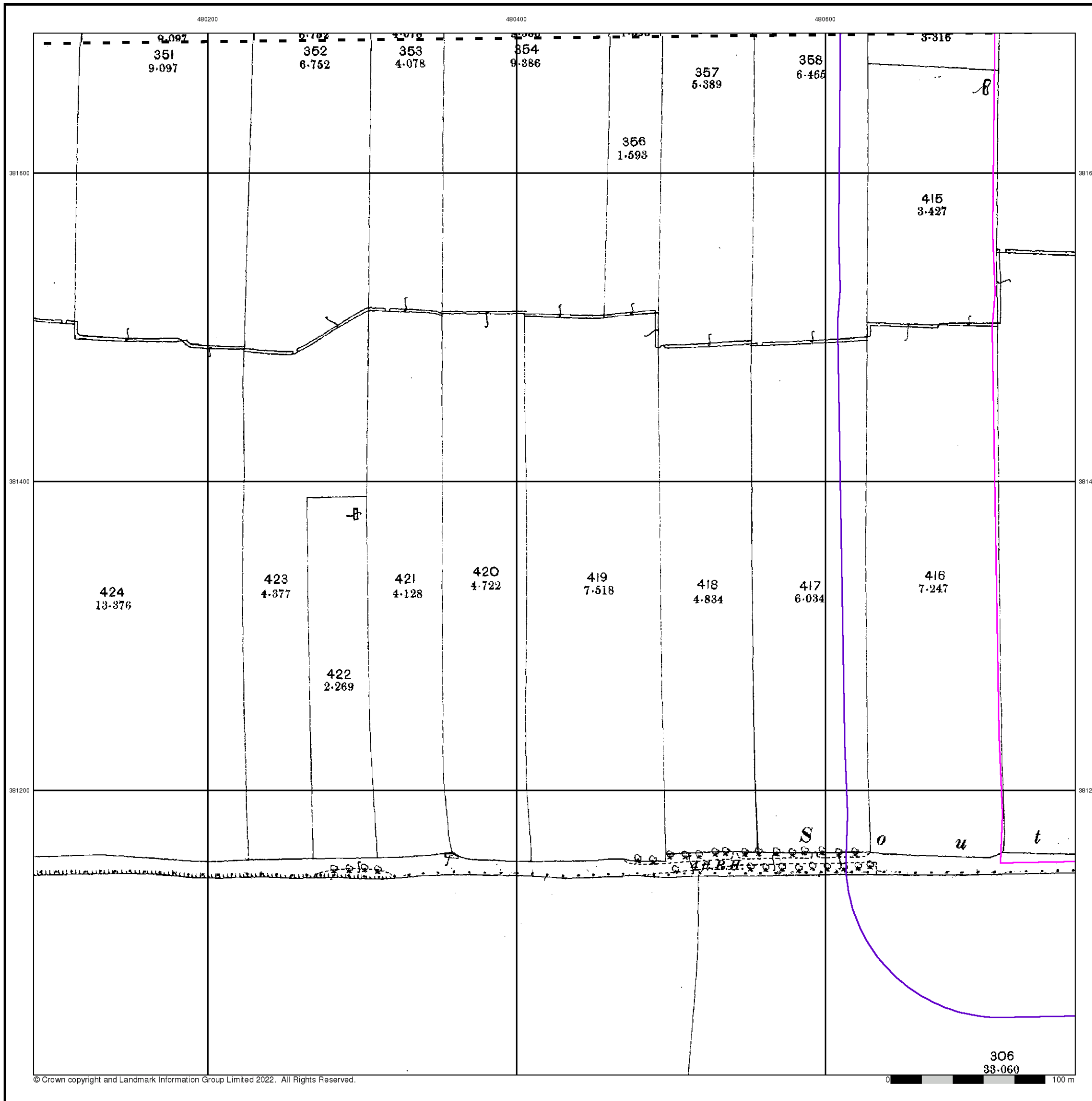

Nottinghamshire

Published 1920

Source map scale - 1:2,500

The historical maps shown were reproduced from maps predominantly held at the scale adopted for England, Wales and Scotland in the 1840's. In 1854 the 1:2,500 scale was adopted for mapping urban areas and by 1896 it covered the whole of what were considered to be the cultivated parts of Great Britain. The published date given below is often some years later than the surveyed date. Before 1938, all OS maps were based on the Cassini Projection, with independent surveys of a single county or group of counties, giving rise to significant inaccuracies in outlying areas.

Map Name(s) and Date(s)

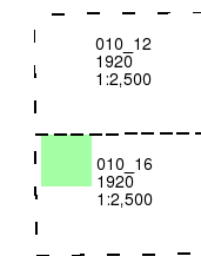

Historical Map - Segment A11

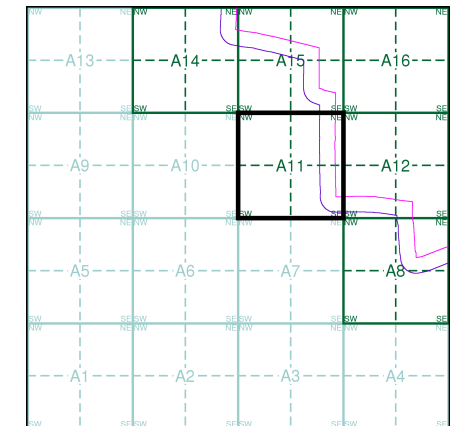

Order Details

Order Number: 298001706_1_1
 Customer Ref: 21-2098.04
 National Grid Reference: 480860, 381630
 Slice: A
 Site Area (Ha): 1355.61
 Search Buffer (m): 100

Site Details

West Barton 2

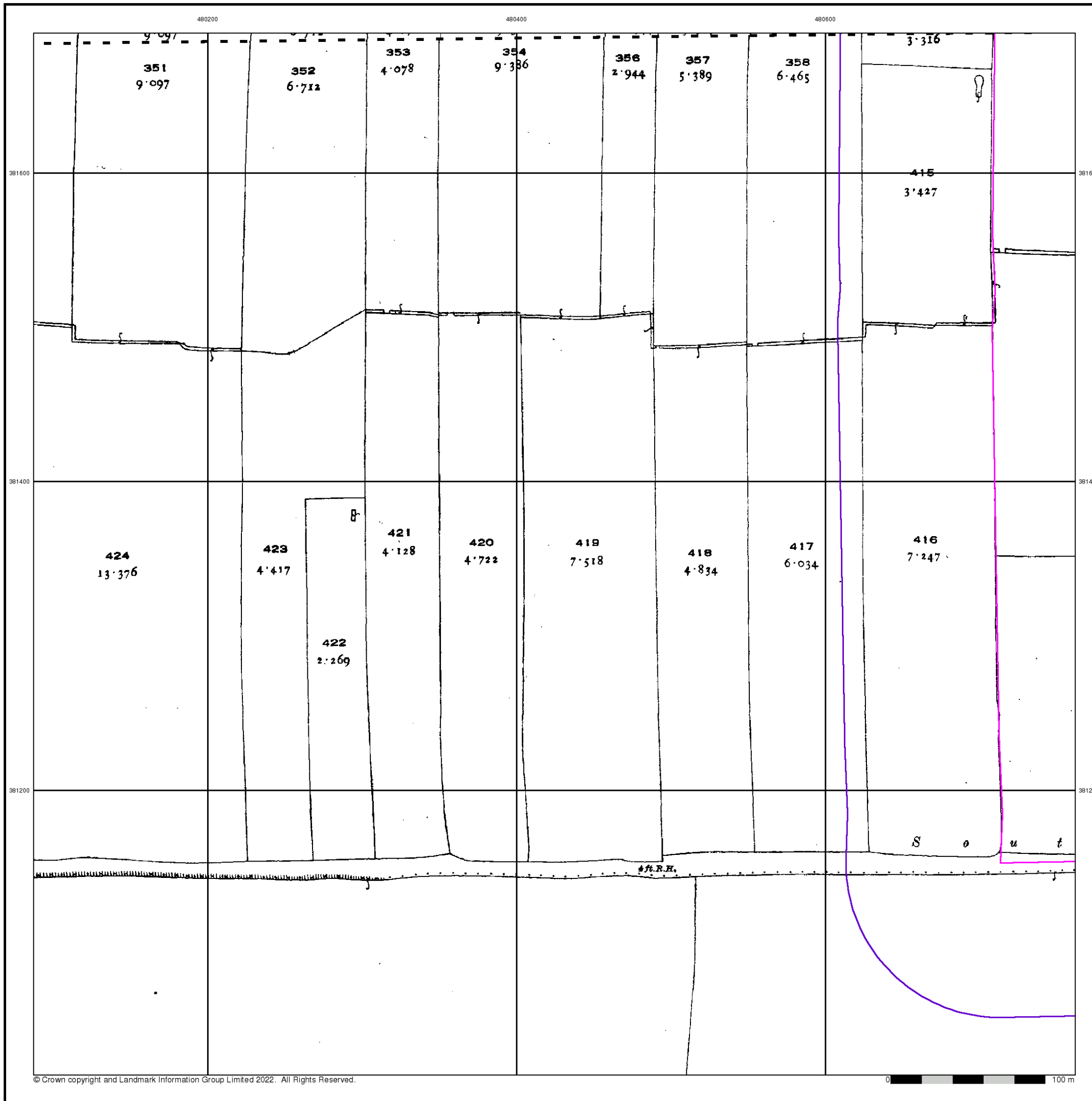

Lincolnshire

Published 1920

Source map scale - 1:2,500

The historical maps shown were reproduced from maps predominantly held at the scale adopted for England, Wales and Scotland in the 1840's. In 1854 the 1:2,500 scale was adopted for mapping urban areas and by 1896 it covered the whole of what were considered to be the cultivated parts of Great Britain. The published date given below is often some years later than the surveyed date. Before 1938, all OS maps were based on the Cassini Projection, with independent surveys of a single county or group of counties, giving rise to significant inaccuracies in outlying areas.

Map Name(s) and Date(s)

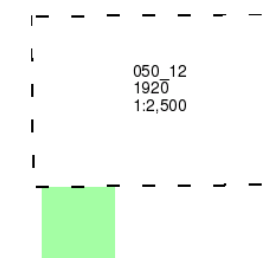

Historical Map - Segment A11

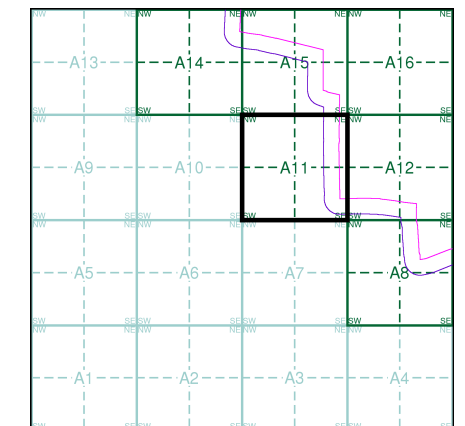

Order Details

Order Number: 298001706_1_1
 Customer Ref: 21-2098.04
 National Grid Reference: 480860, 381630
 Slice: A
 Site Area (Ha): 1355.61
 Search Buffer (m): 100

Site Details

West Barton 2

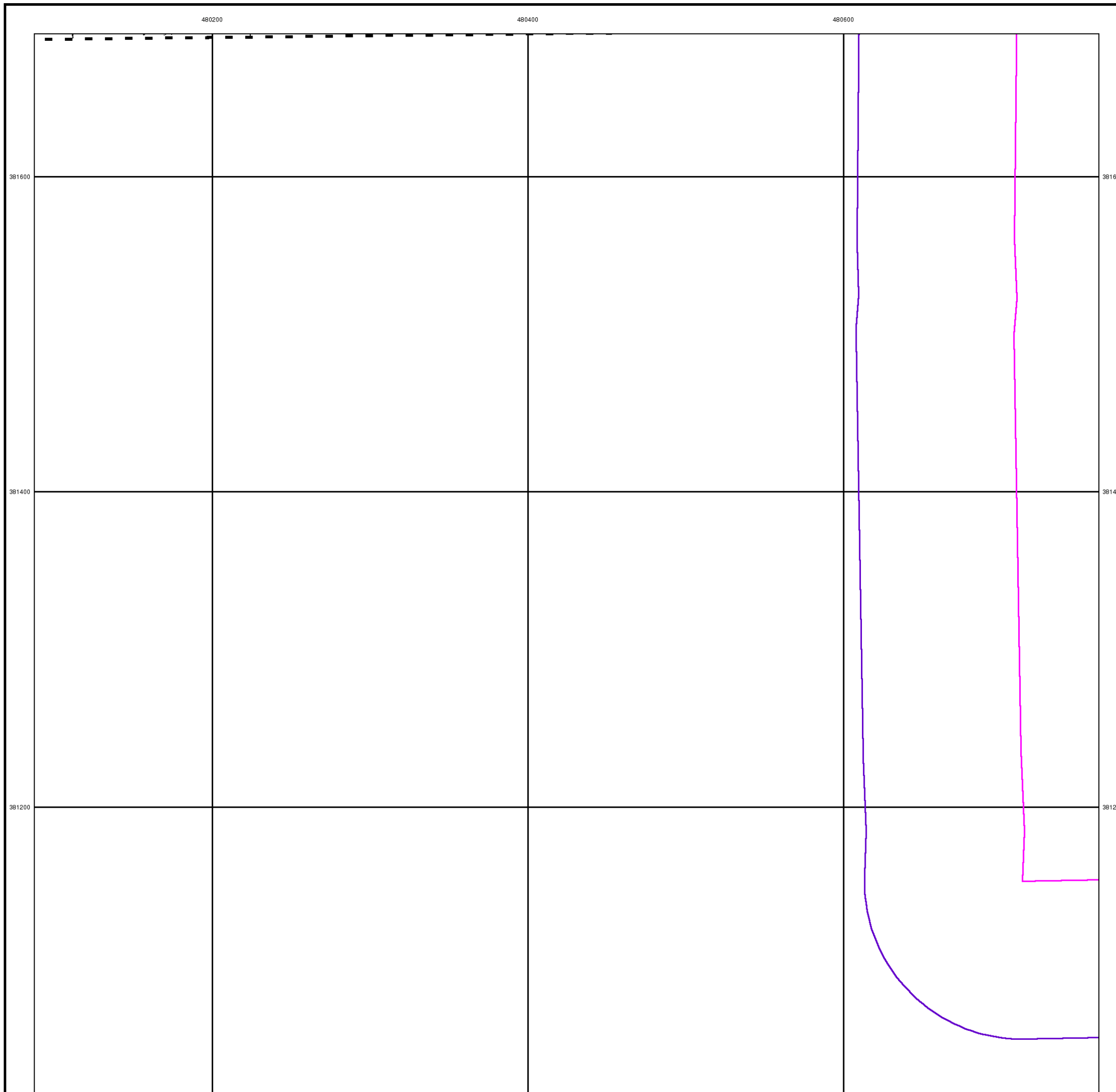

Ordnance Survey Plan

Published 1974

Source map scale - 1:2,500

The historical maps shown were reproduced from maps predominantly held at the scale adopted for England, Wales and Scotland in the 1840's. In 1854 the 1:2,500 scale was adopted for mapping urban areas and by 1896 it covered the whole of what were considered to be the cultivated parts of Great Britain. The published date given below is often some years later than the surveyed date. Before 1938, all OS maps were based on the Cassini Projection, with independent surveys of a single county or group of counties, giving rise to significant inaccuracies in outlying areas.

Map Name(s) and Date(s)

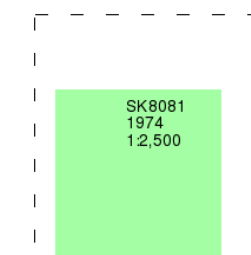

Historical Map - Segment A11

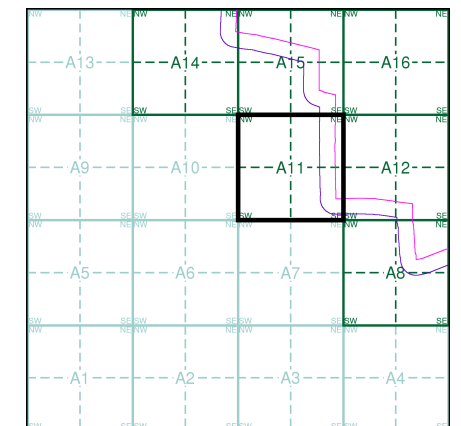

Order Details

Order Number: 298001706_1_1
 Customer Ref: 21-2098.04
 National Grid Reference: 480860, 381630
 Slice: A
 Site Area (Ha): 1355.61
 Search Buffer (m): 100

Site Details

West Barton 2

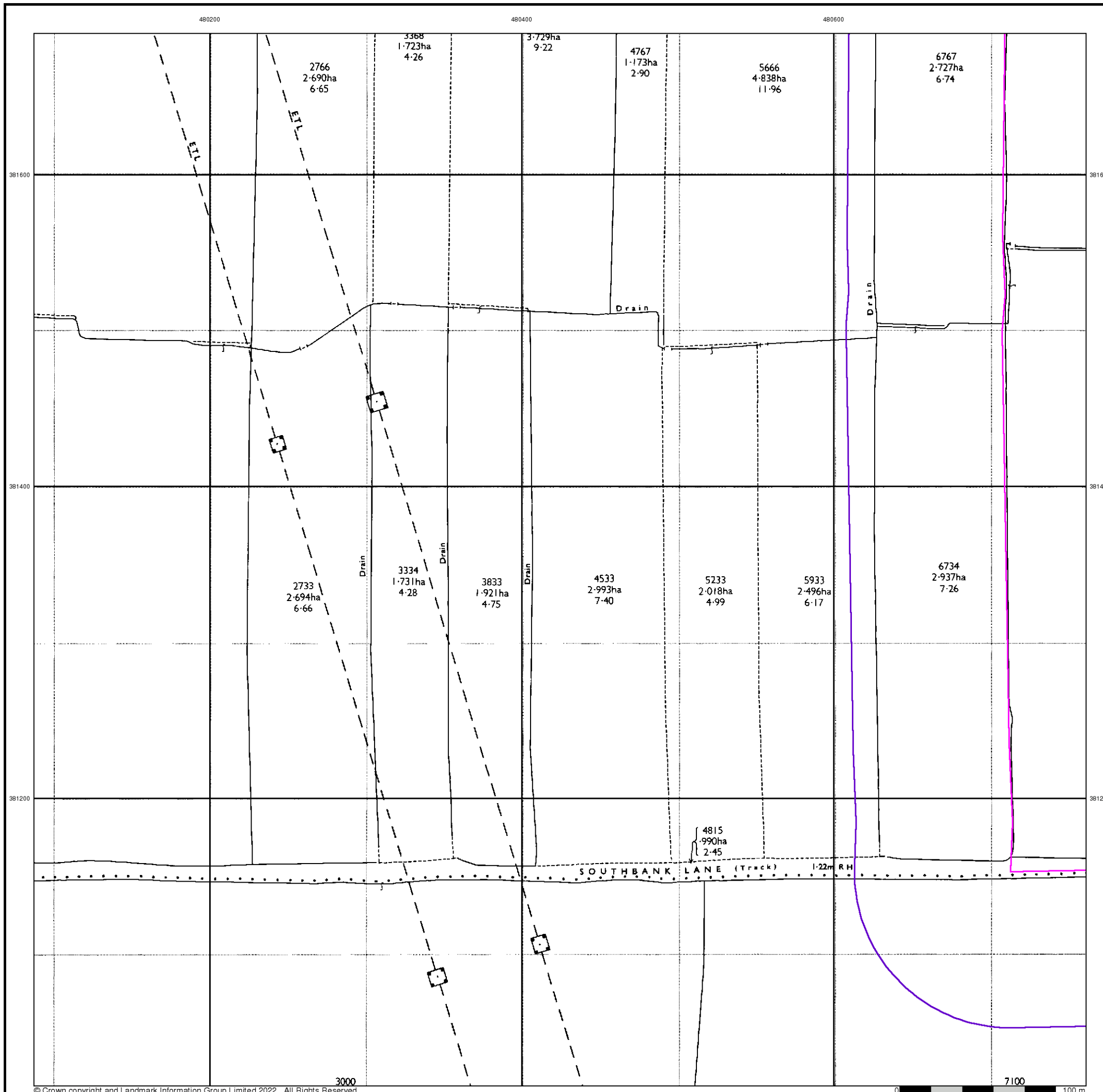

Large-Scale National Grid Data

Published 1994

Source map scale - 1:2,500

'Large Scale National Grid Data' superseded SIM cards (Ordnance Survey's 'Survey of Information on Microfilm') in 1992, and continued to be produced until 1999. These maps were the fore-runners of digital mapping and so provide detailed information on houses and roads, but tend to show less topographic features such as vegetation. These maps were produced at both 1:2,500 and 1:1,250 scales.

Map Name(s) and Date(s)

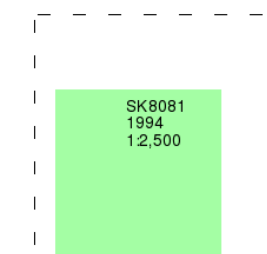

Historical Map - Segment A11

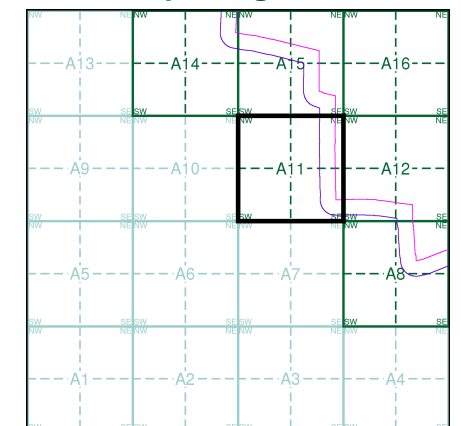

Order Details

Order Number: 298001706_1_1
 Customer Ref: 21-2098.04
 National Grid Reference: 480860, 381630
 Slice: A
 Site Area (Ha): 1355.61
 Search Buffer (m): 100

Site Details

West Barton 2



Historical Mapping Legends

Ordnance Survey County Series and Ordnance Survey Plan 1:2,500

Quarry **Gravel Pit** **Sand Pit**
Clay Pit **Shingle** **Refuse Heap**
Sloping Masonry **Flat Rock**
Marsh **Reeds** **Osiers**
Rough Pasture **Furze** **Wood**
Mixed Wood **Brushwood** **Orchard**
Fir **Ford** **Stepping Stones**
Ferry **Waterfall** **Lock**
Trig. Station **Altitude at Trig. Station**
B.M. 325.9 **Bench Mark** **Surface Level**
Arrow denotes flow of water **Antiquities (site of)**
Cutting **Embankment**
Railway crossing Road **Level Crossing** **Road crossing Railway**
Railway crossing River or Canal **Road over single stream** **Road over River or Canal**
County Boundary (Geographical)
County & Civil Parish Boundary
Administrative County & Civil Parish Boundary
County Borough Boundary (England)
County Burgh Boundary (Scotland)
Co. Boro. Bdy.
Co. Burgh Bdy.
BP BS Boundary Post or Stone **P.C.B** Police Call Box
B.R. Bridle Road **P** Pump
E.P Electricity Pylon **S.P** Signal Post
F.B. Foot Bridge **SL** Sluice
F.P. Foot Path **Sp.** Spring
G.P Guide Post or Board **T.C.B** Telephone Call Box
M.S Mile Stone **Tr.** Trough
M.P M.R Mooring Post or Ring **W** Well

Ordnance Survey Plan, Additional SIMs and Supply of Unpublished Survey Information 1:2,500 and 1:1,250

Inactive Quarry, Chalk Pit or Clay Pit **Active Quarry, Chalk Pit or Clay Pit**
Rock **Boulders**
Cliff **Slopes** **Top**
Roofed Building **Glazed Roof Building**
Sloping Masonry **Archway**
Non-Coniferous Tree (surveyed) **Coniferous Tree (surveyed)**
Non-Coniferous Trees (not surveyed) **Coniferous Trees (not surveyed)**
Orchard Tree **Scrub** **Bracken**
Coppice, Osier **Reeds** **Marsh, Saltings**
Rough Grassland **Heath** **Culvert**
Direction of water flow **Bench Mark** **Antiquity (site of)**
Cave Entrance **Triangulation Station** **Electricity Pylon**
Electricity Transmission Line
County Boundary (Geographical)
County & Civil Parish Boundary
Civil Parish Boundary
Admin. County or County Bor. Boundary
London Borough Boundary
Symbol marking point where boundary mereing changes
BH Beer House **P** Pillar, Pole or Post
BP, BS Boundary Post or Stone **PO** Post Office
Cn, C Capstan, Crane **PC** Public Convenience
Chy Chimney **PH** Public House
D Fn Drinking Fountain **Pp** Pump
EI P Electricity Pillar or Post **SB, S Br** Signal Box or Bridge
FAP Fire Alarm Pillar **SP, SL** Signal Post or Light
FB Foot Bridge **Spr** Spring
GP Guide Post **Tk** Tank or Track
H Hydrant or Hydraulic **TCB** Telephone Call Box
LC Level Crossing **TCP** Telephone Call Post
MH Manhole **Tr** Trough
MP Mile Post or Mooring Post **Wr Pt, Wr T** Water Point, Water Tap
MS Mile Stone **W** Well
NTL Normal Tidal Limit **Wd Pp** Wind Pump

Large-Scale National Grid Data 1:2,500 and 1:1,250

Cliff **Slopes** **Top**
Rock **Rock (scattered)**
Boulders **Boulders (scattered)**
Positioned Boulder **Scree**
Non-Coniferous Tree (surveyed) **Coniferous Tree (surveyed)**
Non-Coniferous Trees (not surveyed) **Coniferous Trees (not surveyed)**
Orchard Tree **Scrub** **Bracken**
Coppice, Osier **Reeds** **Marsh, Saltings**
Rough Grassland **Heath** **Culvert**
Direction of water flow **Triangulation Station** **Antiquity (site of)**
Electricity Transmission Line **Electricity Pylon**
BM 231.60m **Bench Mark** **Buildings with Building Seed**
Roofed Building **Glazed Roof Building**
Civil parish/community boundary
District boundary
County boundary
Boundary post/stone
Boundary mereing symbol (note: these always appear in opposed pairs or groups of three)
Bks Barracks **P** Pillar, Pole or Post
Bty Battery **PO** Post Office
Cemy Cemetery **PC** Public Convenience
Chy Chimney **Pp** Pump
Cis Cistern **Ppg Sta** Pumping Station
Dismtd Rly Dismantled Railway **PW** Place of Worship
EI Gen Sta Electricity Generating Station **Sewage Ppg Sta** Sewage Pumping Station
EI P Electricity Pole, Pillar **SB, S Br** Signal Box or Bridge
EI Sub Sta Electricity Sub Station **SP, SL** Signal Post or Light
FB Filter Bed **Spr** Spring
Fn / D Fn Fountain / Drinking Ftn. **Tk** Tank or Track
Gas Gov Gas Valve Compound **Tr** Trough
GVC Gas Governor **Wd Pp** Wind Pump
GP Guide Post **Wr Pt, Wr T** Water Point, Water Tap
MH Manhole **Wks** Works (building or area)
MP, MS Mile Post or Mile Stone **W** Well



Historical Mapping & Photography included:

Mapping Type	Scale	Date	Pg
Nottinghamshire	1:2,500	1886	2
Nottinghamshire	1:2,500	1899	3
Nottinghamshire	1:2,500	1920	4
Ordnance Survey Plan	1:2,500	1974	5
Large-Scale National Grid Data	1:2,500	1994	6

Historical Map - Segment A12

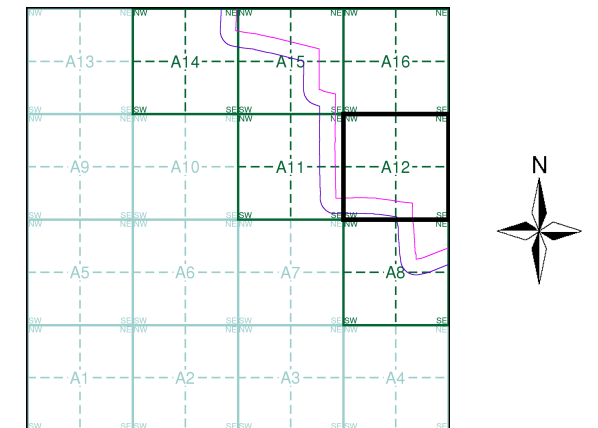

Order Details

Order Number: 298001706_1_1
 Customer Ref: 21-2098.04
 National Grid Reference: 480860, 381630
 Slice: A
 Site Area (Ha): 1355.61
 Search Buffer (m): 100

Site Details

West Barton 2



Tel: 0844 844 9952
 Fax: 0844 844 9951
 Web: [REDACTED]

Nottinghamshire

Published 1886

Source map scale - 1:2,500

The historical maps shown were reproduced from maps predominantly held at the scale adopted for England, Wales and Scotland in the 1840's. In 1854 the 1:2,500 scale was adopted for mapping urban areas and by 1896 it covered the whole of what were considered to be the cultivated parts of Great Britain. The published date given below is often some years later than the surveyed date. Before 1938, all OS maps were based on the Cassini Projection, with independent surveys of a single county or group of counties, giving rise to significant inaccuracies in outlying areas.

Map Name(s) and Date(s)

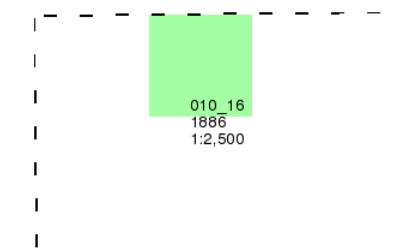

Historical Map - Segment A12

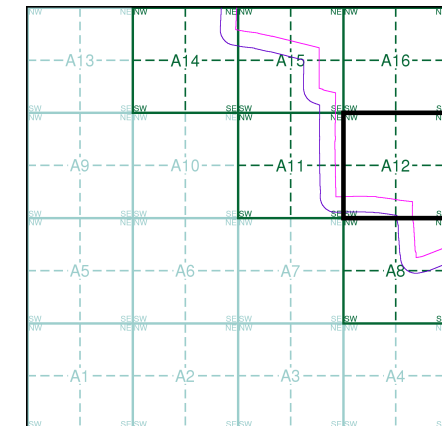

Order Details

Order Number: 298001706_1_1
 Customer Ref: 21-2098.04
 National Grid Reference: 480860, 381630
 Slice: A
 Site Area (Ha): 1355.61
 Search Buffer (m): 100

Site Details

West Barton 2

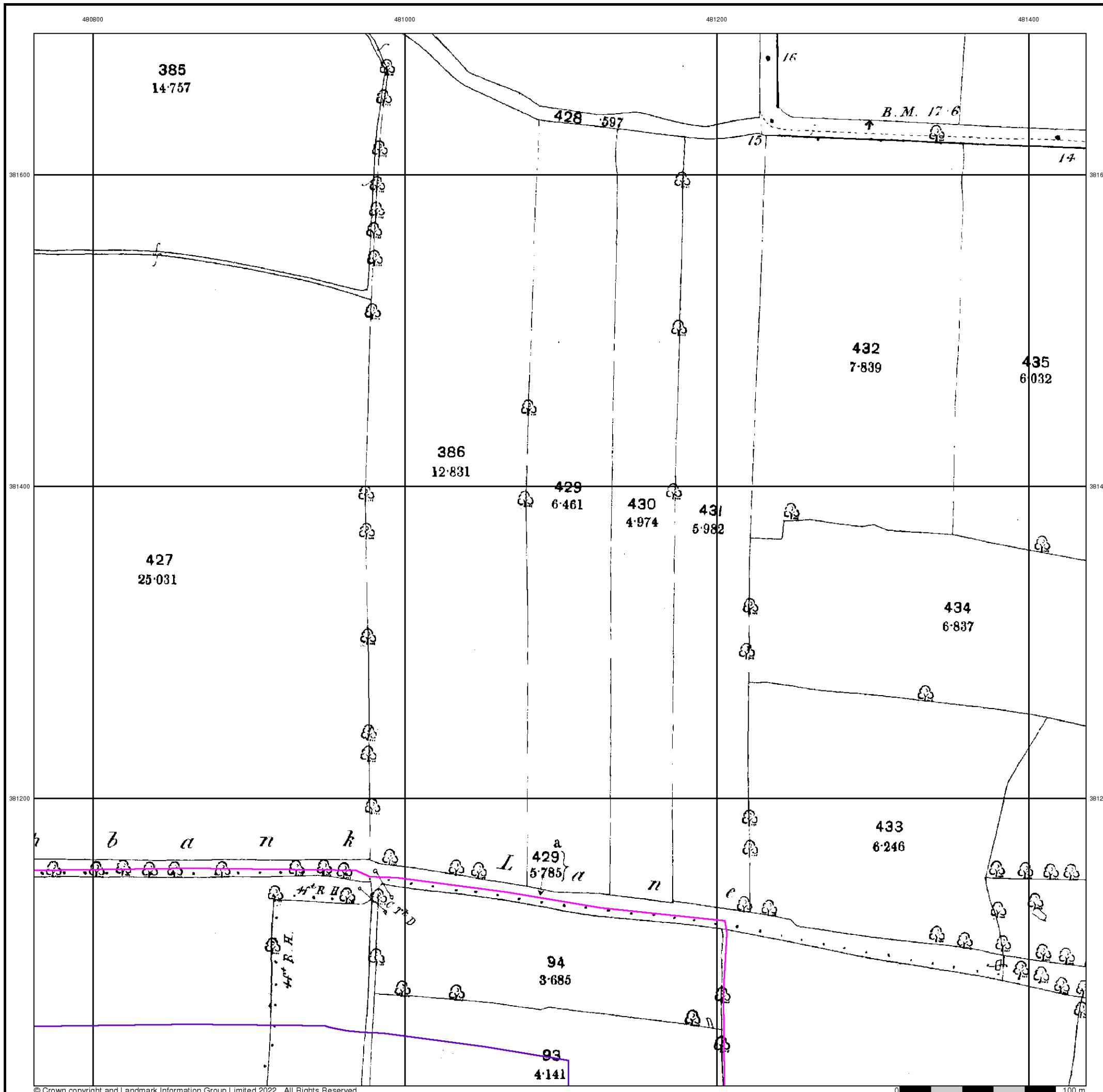

Nottinghamshire

Published 1899

Source map scale - 1:2,500

The historical maps shown were reproduced from maps predominantly held at the scale adopted for England, Wales and Scotland in the 1840's. In 1854 the 1:2,500 scale was adopted for mapping urban areas and by 1896 it covered the whole of what were considered to be the cultivated parts of Great Britain. The published date given below is often some years later than the surveyed date. Before 1938, all OS maps were based on the Cassini Projection, with independent surveys of a single county or group of counties, giving rise to significant inaccuracies in outlying areas.

Map Name(s) and Date(s)

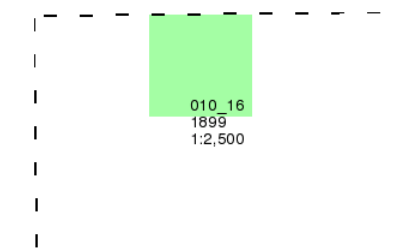

Historical Map - Segment A12

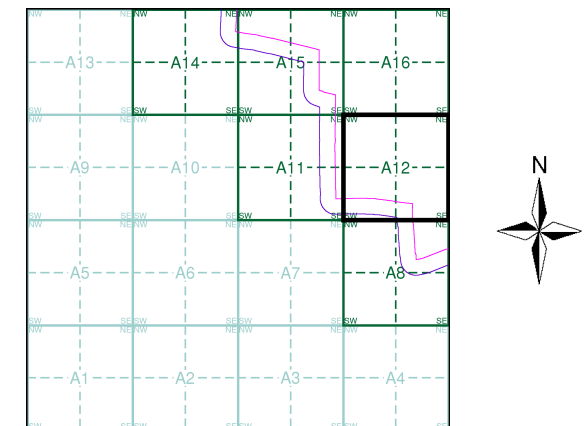

Order Details

Order Number: 298001706_1_1
 Customer Ref: 21-2098.04
 National Grid Reference: 480860, 381630
 Slice: A
 Site Area (Ha): 1355.61
 Search Buffer (m): 100

Site Details

West Barton 2

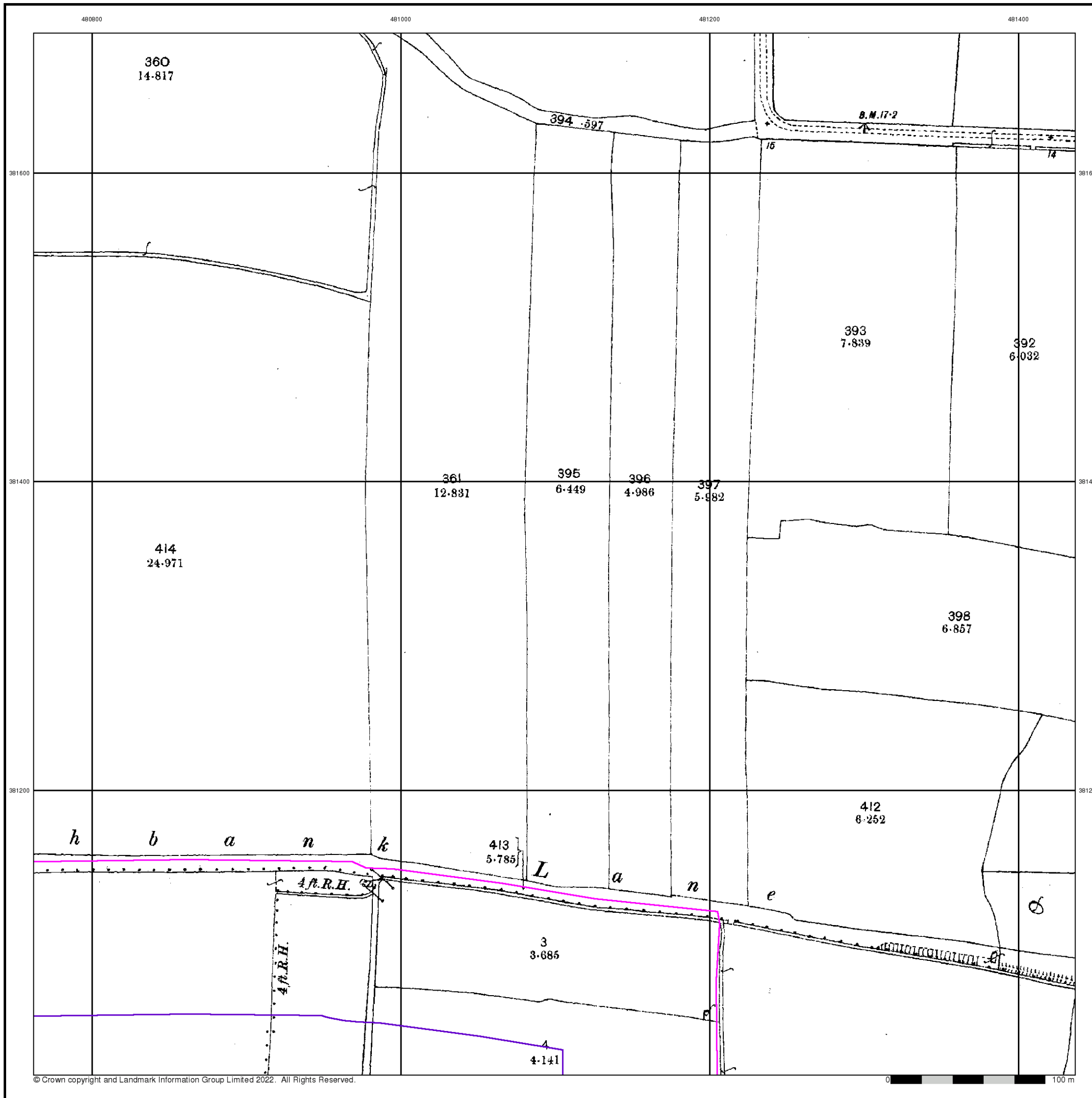

Nottinghamshire

Published 1920

Source map scale - 1:2,500

The historical maps shown were reproduced from maps predominantly held at the scale adopted for England, Wales and Scotland in the 1840's. In 1854 the 1:2,500 scale was adopted for mapping urban areas and by 1896 it covered the whole of what were considered to be the cultivated parts of Great Britain. The published date given below is often some years later than the surveyed date. Before 1938, all OS maps were based on the Cassini Projection, with independent surveys of a single county or group of counties, giving rise to significant inaccuracies in outlying areas.

Map Name(s) and Date(s)

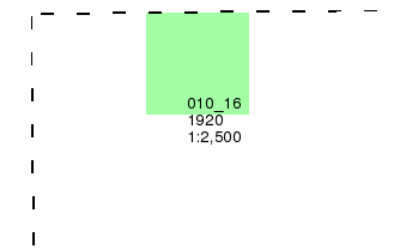

Historical Map - Segment A12

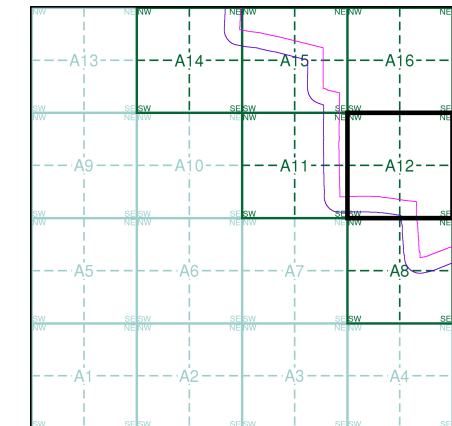

Order Details

Order Number: 298001706_1_1
 Customer Ref: 21-2098.04
 National Grid Reference: 480860, 381630
 Slice: A
 Site Area (Ha): 1355.61
 Search Buffer (m): 100

Site Details

West Barton 2



Ordnance Survey Plan

Published 1974

Source map scale - 1:2,500

The historical maps shown were reproduced from maps predominantly held at the scale adopted for England, Wales and Scotland in the 1840's. In 1854 the 1:2,500 scale was adopted for mapping urban areas and by 1896 it covered the whole of what were considered to be the cultivated parts of Great Britain. The published date given below is often some years later than the surveyed date. Before 1938, all OS maps were based on the Cassini Projection, with independent surveys of a single county or group of counties, giving rise to significant inaccuracies in outlying areas.

Map Name(s) and Date(s)

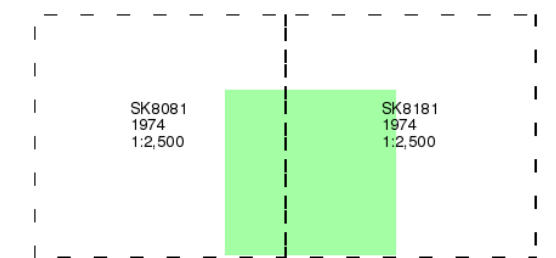

Historical Map - Segment A12

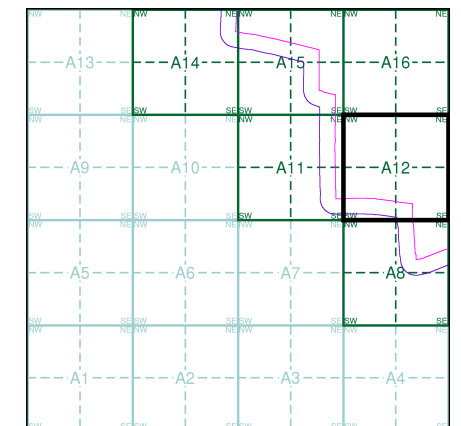

Order Details

Order Number: 298001706_1_1
 Customer Ref: 21-2098.04
 National Grid Reference: 480860, 381630
 Slice: A
 Site Area (Ha): 1355.61
 Search Buffer (m): 100

Site Details

West Barton 2



Large-Scale National Grid Data

Published 1994

Source map scale - 1:2,500

'Large Scale National Grid Data' superseded SIM cards (Ordnance Survey's 'Survey of Information on Microfilm') in 1992, and continued to be produced until 1999. These maps were the fore-runners of digital mapping and so provide detailed information on houses and roads, but tend to show less topographic features such as vegetation. These maps were produced at both 1:2,500 and 1:1,250 scales.

Map Name(s) and Date(s)

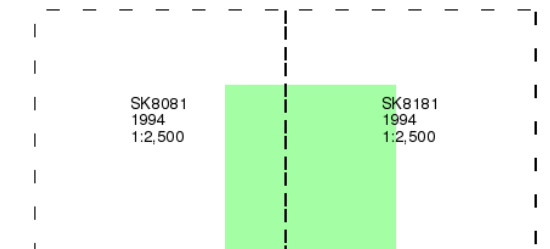

Historical Map - Segment A12

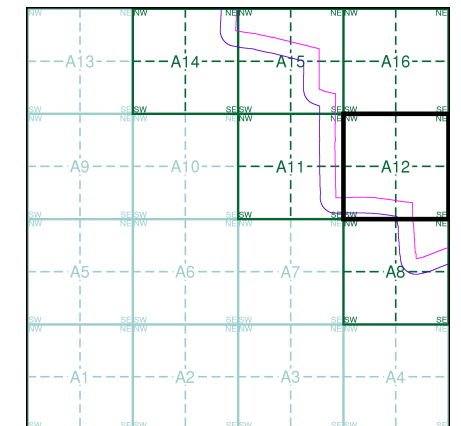

Order Details

Order Number: 298001706_1_1
 Customer Ref: 21-2098.04
 National Grid Reference: 480860, 381630
 Slice: A
 Site Area (Ha): 1355.61
 Search Buffer (m): 100

Site Details

West Barton 2



Historical Mapping Legends

Ordnance Survey County Series and Ordnance Survey Plan 1:2,500

Quarry **Gravel Pit** **Sand Pit**
Clay Pit **Shingle** **Refuse Heap**
Sloping Masonry **Flat Rock**
Marsh **Reeds** **Osiers**
Rough Pasture **Furze** **Wood**
Mixed Wood **Brushwood** **Orchard**
Fir **Ford** **Stepping Stones**
Ferry **Waterfall** **Lock**
Trig. Station **Altitude at Trig. Station**
B.M. 325.9 **Bench Mark** **Surface Level**
Arrow denotes flow of water **Antiquities (site of)**
Cutting **Embankment**
Railway crossing Road **Level Crossing** **Road crossing Railway**
Railway crossing River or Canal **Road over single stream** **Road over River or Canal**
County Boundary (Geographical)
County & Civil Parish Boundary
Administrative County & Civil Parish Boundary
County Borough Boundary (England)
Co. Boro. Bdy.
County Burgh Boundary (Scotland)
Boundary Post or Stone **Police Call Box**
B.R. **Bridle Road** **P** **Pump**
E.P. **Electricity Pylon** **S.P.** **Signal Post**
F.B. **Foot Bridge** **Sl.** **Sluice**
F.P. **Foot Path** **Sp.** **Spring**
G.P. **Guide Post or Board** **T.C.B.** **Telephone Call Box**
M.S. **Mile Stone** **Tr.** **Trough**
M.P. M.R. **Mooring Post or Ring** **W** **Well**

Ordnance Survey Plan, Additional SIMs and Supply of Unpublished Survey Information 1:2,500 and 1:1,250

Inactive Quarry, Chalk Pit or Clay Pit **Active Quarry, Chalk Pit or Clay Pit**
Rock **Boulders**
Cliff **Slopes** **Top**
Roofed Building **Glazed Roof Building**
Sloping Masonry **Archway**
Non-Coniferous Tree (surveyed) **Coniferous Tree (surveyed)**
Non-Coniferous Trees (not surveyed) **Coniferous Trees (not surveyed)**
Orchard Tree **Scrub** **Bracken**
Coppice, Osier **Reeds** **Marsh, Saltings**
Rough Grassland **Heath** **Culvert**
Direction of water flow **Bench Mark** **Antiquity (site of)**
Cave Entrance **Triangulation Station** **Electricity Pylon**
Electricity Transmission Line
County Boundary (Geographical)
County & Civil Parish Boundary
Civil Parish Boundary
Admin. County or County Bor. Boundary
London Borough Boundary
Symbol marking point where boundary mereing changes
Beer House **Pillar, Pole or Post**
Boundary Post or Stone **Post Office**
Capstan, Crane **Public Convenience**
Chimney **Public House**
Drinking Fountain **Pump**
Electricity Pillar or Post **Signal Box or Bridge**
Fire Alarm Pillar **Signal Post or Light**
Foot Bridge **Spring**
Guide Post **Tank or Track**
Hydrant or Hydraulic **Telephone Call Box**
Level Crossing **Telephone Call Post**
Manhole **Trough**
Mile Post or Mooring Post **Water Point, Water Tap**
Mile Stone **Well**
Normal Tidal Limit **Wind Pump**

Large-Scale National Grid Data 1:2,500 and 1:1,250

Cliff **Slopes** **Top**
Rock **Rock (scattered)**
Boulders **Boulders (scattered)**
Positioned Boulder **Scree**
Non-Coniferous Tree (surveyed) **Coniferous Tree (surveyed)**
Non-Coniferous Trees (not surveyed) **Coniferous Trees (not surveyed)**
Orchard Tree **Scrub** **Bracken**
Coppice, Osier **Reeds** **Marsh, Saltings**
Rough Grassland **Heath** **Culvert**
Direction of water flow **Triangulation Station** **Antiquity (site of)**
Electricity Transmission Line **Electricity Pylon**
Bench Mark **Buildings with Building Seed**
Roofed Building **Glazed Roof Building**
Civil parish/community boundary
District boundary
County boundary
Boundary post/stone
Boundary mereing symbol (note: these always appear in opposed pairs or groups of three)
Barracks **Pillar, Pole or Post**
Battery **Post Office**
Cemetery **Public Convenience**
Chimney **Pump**
Cistern **Pumping Station**
Dismtd Rly **Place of Worship**
Electricity Generating Station **Sewage Ppg Sta** **Sewage Pumping Station**
Electricity Pole, Pillar **Signal Box or Bridge**
Electricity Sub Station **Signal Post or Light**
Filter Bed **Spring**
Fountain / Drinking Ftn. **Tank or Track**
Gas Valve Compound **Trough**
Gas Governor **Wind Pump**
Guide Post **Water Point, Water Tap**
Manhole **Works (building or area)**
Mile Post or Mile Stone **Well**

Historical Mapping & Photography included:

Mapping Type	Scale	Date	Pg
Lincolnshire	1:2,500	1886	2
Nottinghamshire	1:2,500	1886	3
Nottinghamshire	1:2,500	1899	4
Nottinghamshire	1:2,500	1920	5
Lincolnshire	1:2,500	1920	6
Ordnance Survey Plan	1:2,500	1973 - 1974	7
Ordnance Survey Plan	1:2,500	1992	8
Large-Scale National Grid Data	1:2,500	1994	9

Historical Map - Segment A14

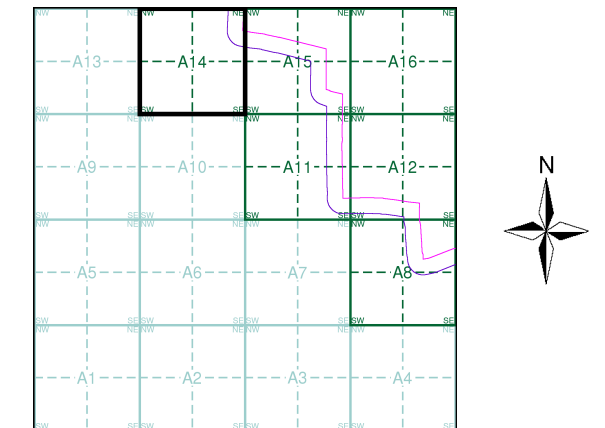

Order Details

Order Number: 298001706_1_1
 Customer Ref: 21-2098.04
 National Grid Reference: 480860, 381630
 Slice: A
 Site Area (Ha): 1355.61
 Search Buffer (m): 100

Site Details

West Barton 2

Lincolnshire
Published 1886

Source map scale - 1:2,500

The historical maps shown were reproduced from maps predominantly held at the scale adopted for England, Wales and Scotland in the 1840's. In 1854 the 1:2,500 scale was adopted for mapping urban areas and by 1896 it covered the whole of what were considered to be the cultivated parts of Great Britain. The published date given below is often some years later than the surveyed date. Before 1938, all OS maps were based on the Cassini Projection, with independent surveys of a single county or group of counties, giving rise to significant inaccuracies in outlying areas.

Map Name(s) and Date(s)

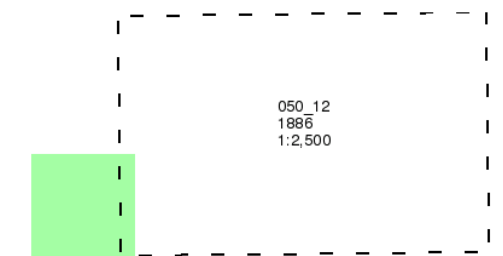

Historical Map - Segment A14

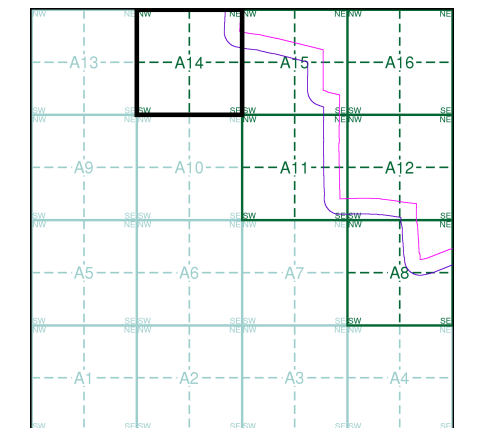

Order Details

Order Number: 298001706_1_1
 Customer Ref: 21-2098.04
 National Grid Reference: 480860, 381630
 Slice: A
 Site Area (Ha): 1355.61
 Search Buffer (m): 100

Site Details

West Barton 2

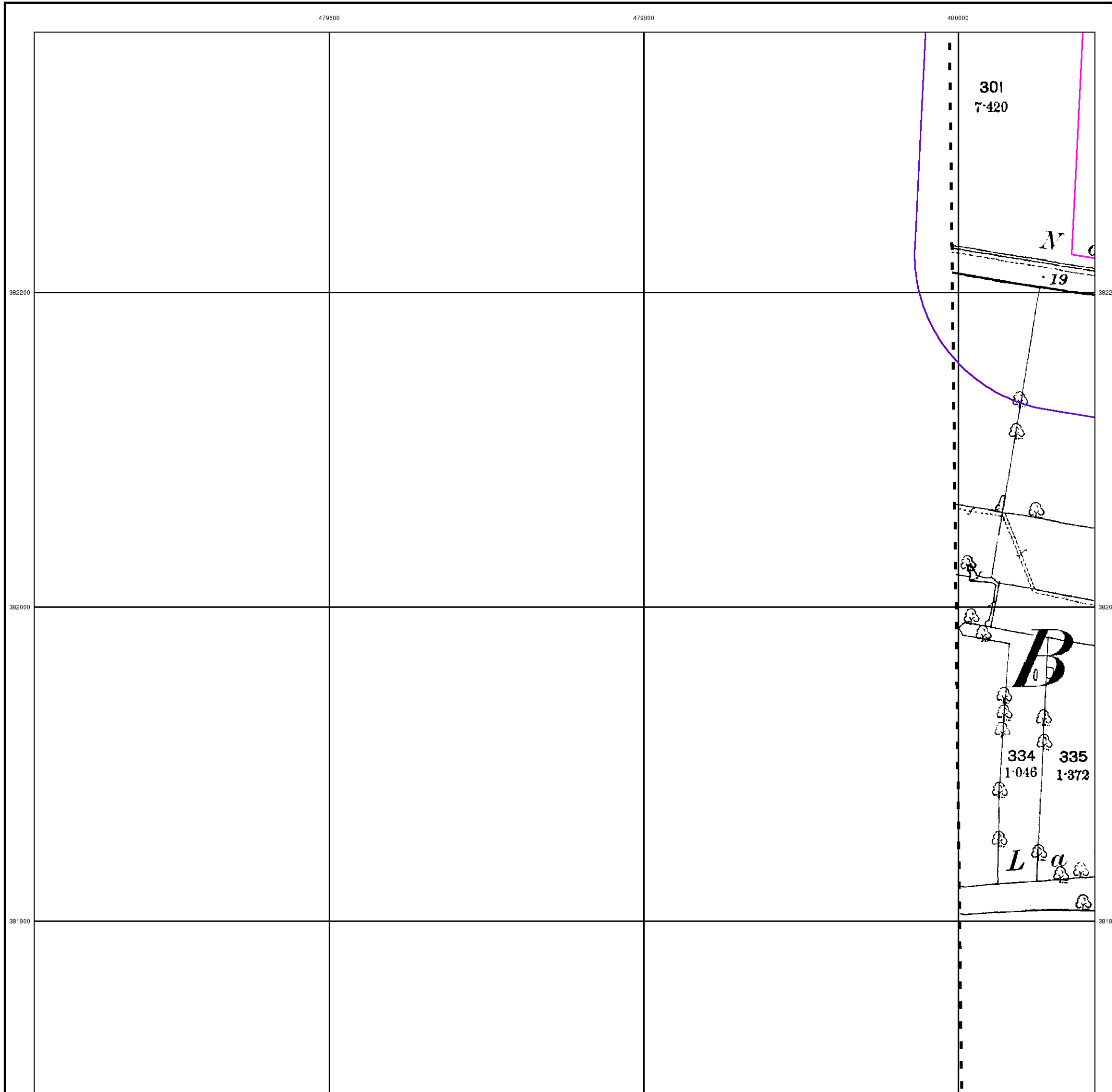

Nottinghamshire

Published 1886

Source map scale - 1:2,500

The historical maps shown were reproduced from maps predominantly held at the scale adopted for England, Wales and Scotland in the 1840's. In 1854 the 1:2,500 scale was adopted for mapping urban areas and by 1896 it covered the whole of what were considered to be the cultivated parts of Great Britain. The published date given below is often some years later than the surveyed date. Before 1938, all OS maps were based on the Cassini Projection, with independent surveys of a single county or group of counties, giving rise to significant inaccuracies in outlying areas.

Map Name(s) and Date(s)

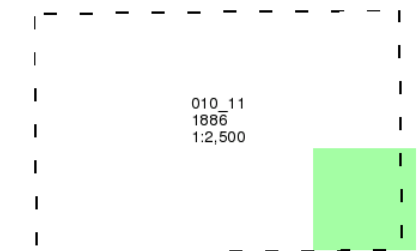

Historical Map - Segment A14

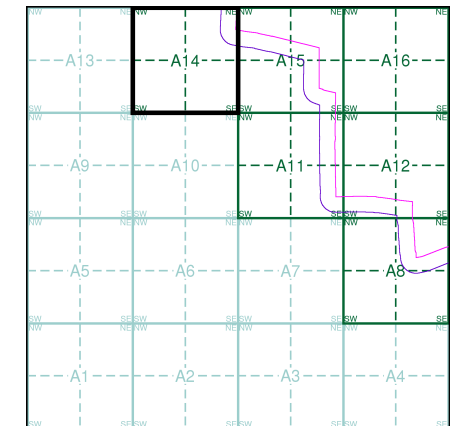

Order Details

Order Number: 298001706_1_1
 Customer Ref: 21-2098.04
 National Grid Reference: 480860, 381630
 Slice: A
 Site Area (Ha): 1355.61
 Search Buffer (m): 100

Site Details

West Barton 2

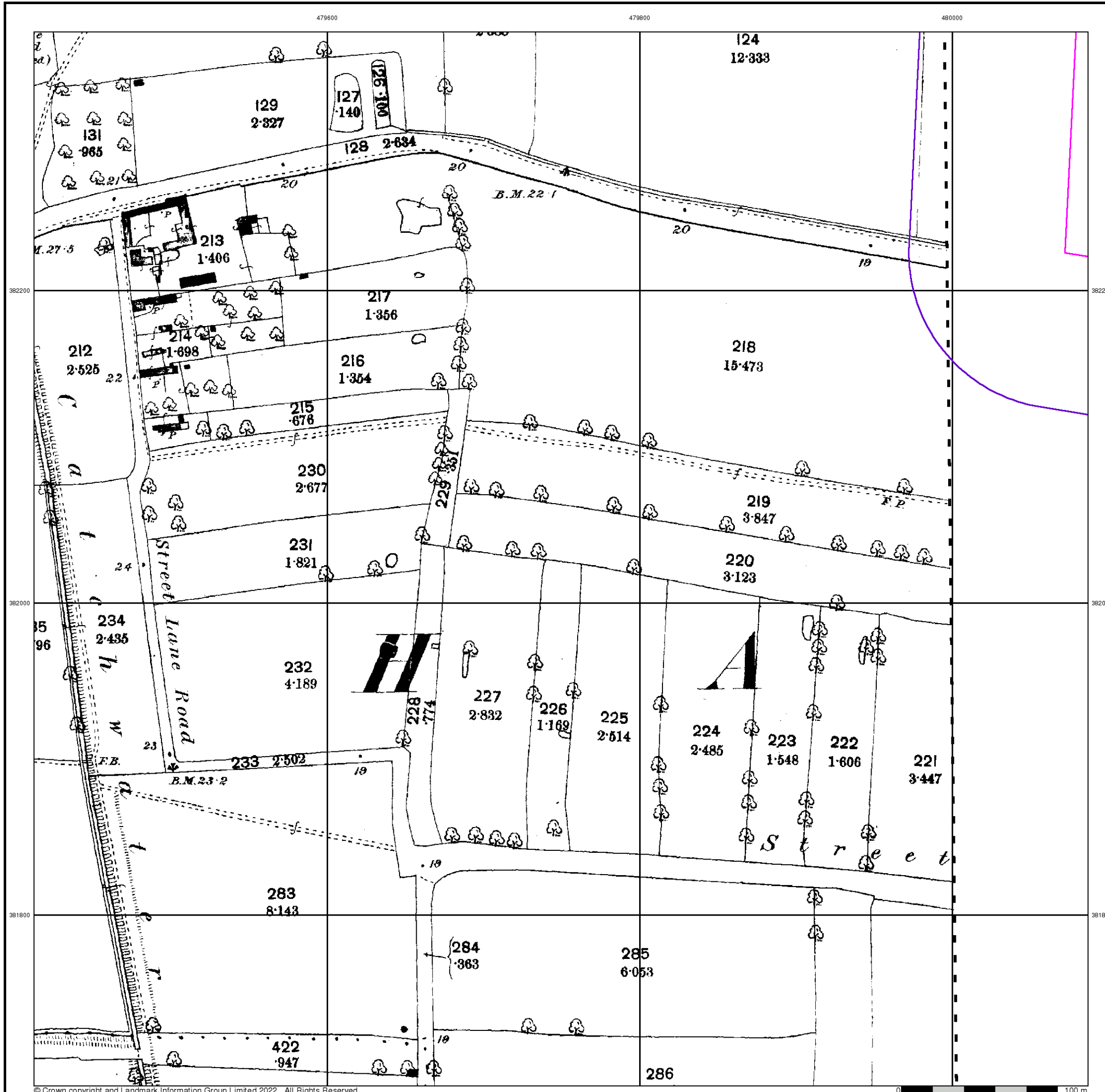

Nottinghamshire

Published 1899

Source map scale - 1:2,500

The historical maps shown were reproduced from maps predominantly held at the scale adopted for England, Wales and Scotland in the 1840's. In 1854 the 1:2,500 scale was adopted for mapping urban areas and by 1896 it covered the whole of what were considered to be the cultivated parts of Great Britain. The published date given below is often some years later than the surveyed date. Before 1938, all OS maps were based on the Cassini Projection, with independent surveys of a single county or group of counties, giving rise to significant inaccuracies in outlying areas.

Map Name(s) and Date(s)

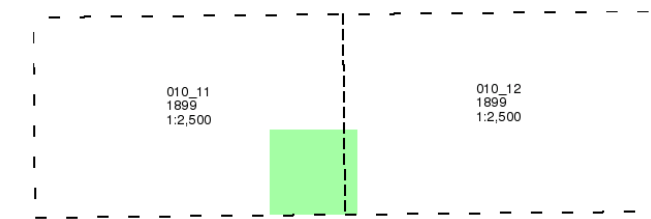

Historical Map - Segment A14

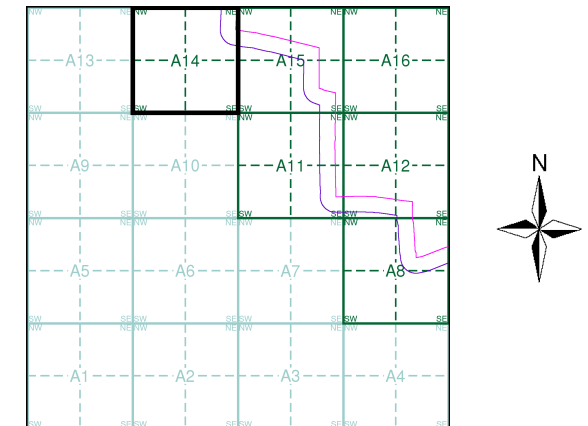

Order Details

Order Number: 298001706_1_1
 Customer Ref: 21-2098.04
 National Grid Reference: 480860, 381630
 Slice: A
 Site Area (Ha): 1355.61
 Search Buffer (m): 100

Site Details

West Barton 2



Nottinghamshire

Published 1920

Source map scale - 1:2,500

The historical maps shown were reproduced from maps predominantly held at the scale adopted for England, Wales and Scotland in the 1840's. In 1854 the 1:2,500 scale was adopted for mapping urban areas and by 1896 it covered the whole of what were considered to be the cultivated parts of Great Britain. The published date given below is often some years later than the surveyed date. Before 1938, all OS maps were based on the Cassini Projection, with independent surveys of a single county or group of counties, giving rise to significant inaccuracies in outlying areas.

Map Name(s) and Date(s)

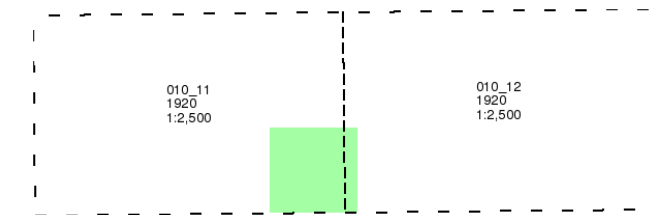

Historical Map - Segment A14

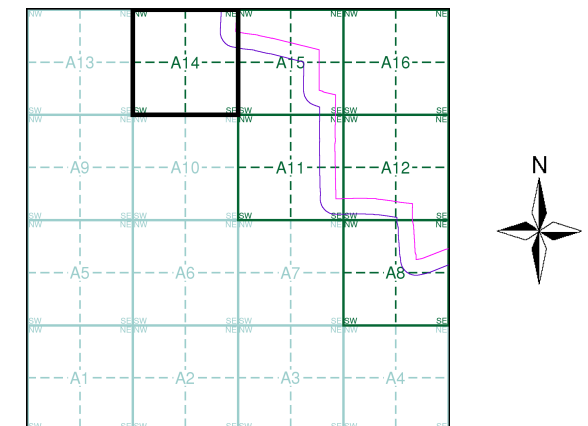

Order Details

Order Number: 298001706_1_1
 Customer Ref: 21-2098.04
 National Grid Reference: 480860, 381630
 Slice: A
 Site Area (Ha): 1355.61
 Search Buffer (m): 100

Site Details

West Barton 2

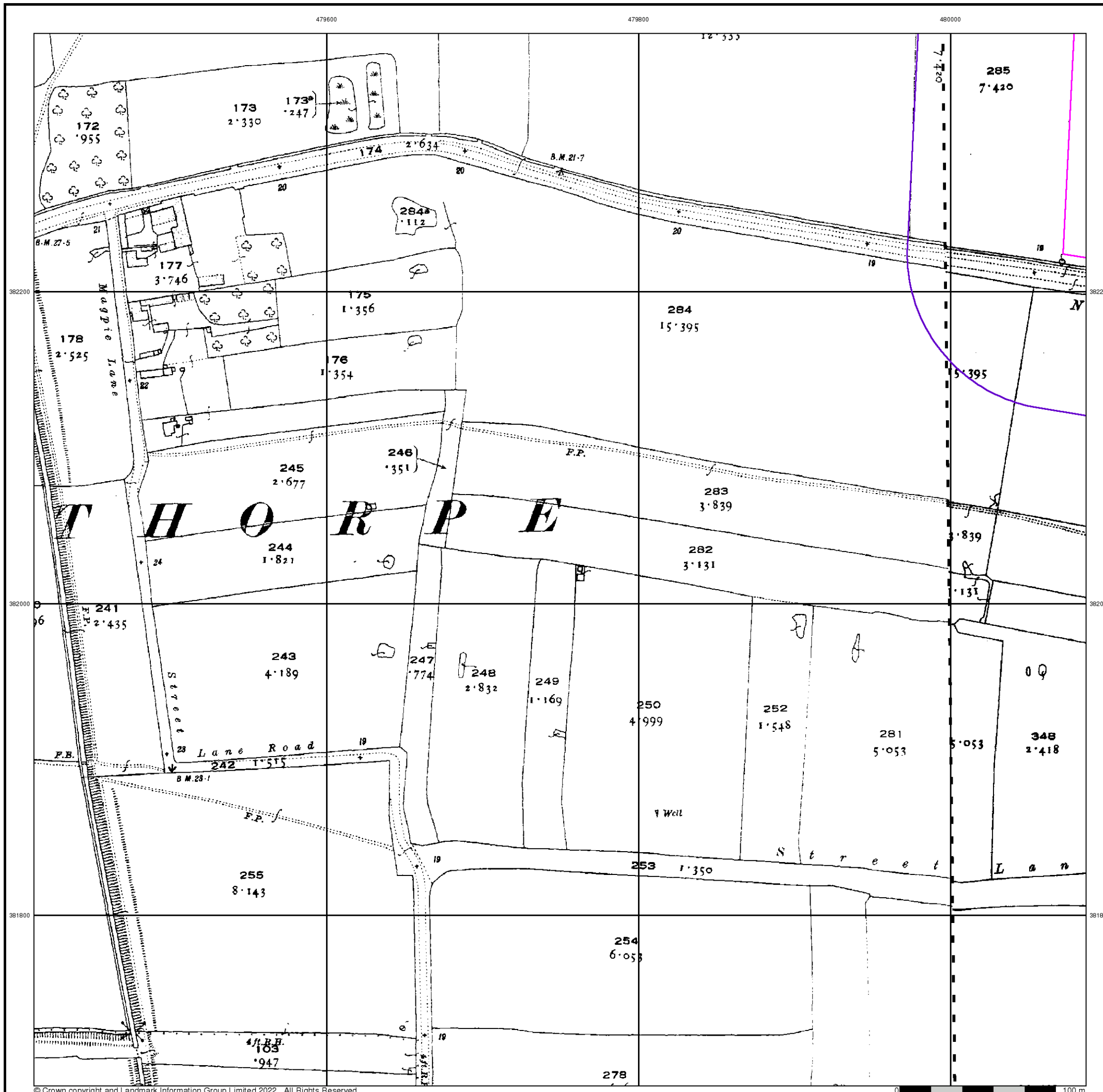

Lincolnshire

Published 1920

Source map scale - 1:2,500

The historical maps shown were reproduced from maps predominantly held at the scale adopted for England, Wales and Scotland in the 1840's. In 1854 the 1:2,500 scale was adopted for mapping urban areas and by 1896 it covered the whole of what were considered to be the cultivated parts of Great Britain. The published date given below is often some years later than the surveyed date. Before 1938, all OS maps were based on the Cassini Projection, with independent surveys of a single county or group of counties, giving rise to significant inaccuracies in outlying areas.

Map Name(s) and Date(s)

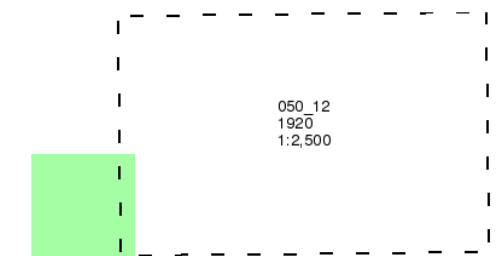

Historical Map - Segment A14

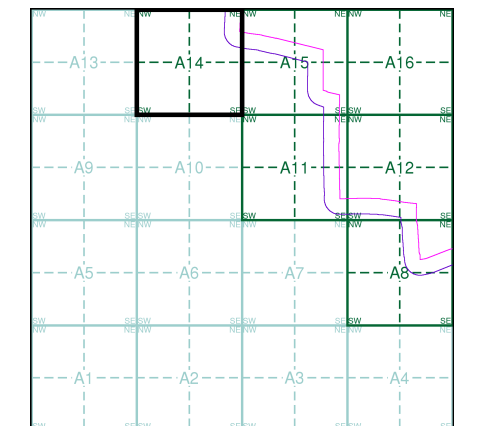

Order Details

Order Number: 298001706_1_1
 Customer Ref: 21-2098.04
 National Grid Reference: 480860, 381630
 Slice: A
 Site Area (Ha): 1355.61
 Search Buffer (m): 100

Site Details

West Barton 2

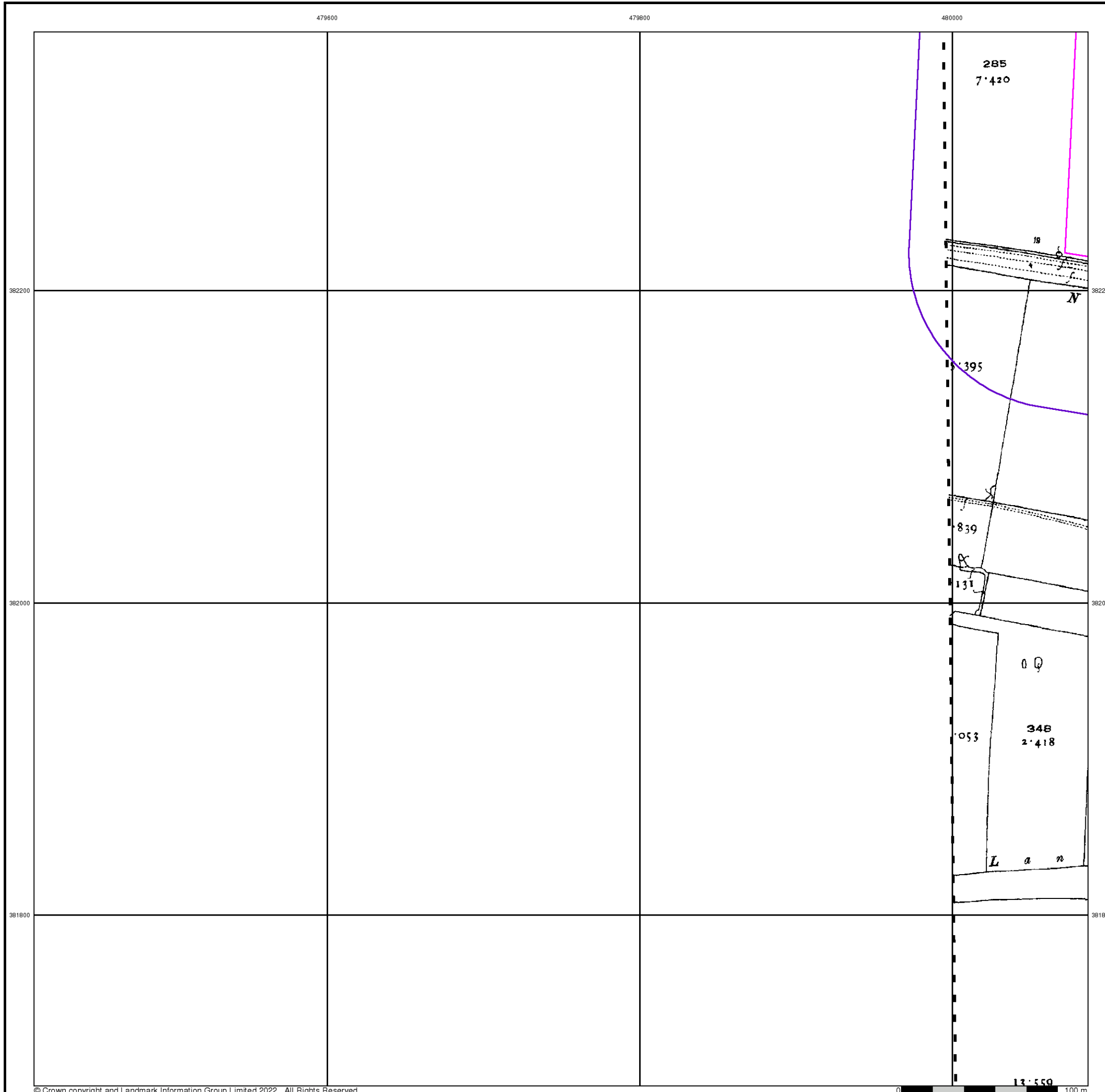

Ordnance Survey Plan
Published 1973 - 1974
Source map scale - 1:2,500

The historical maps shown were reproduced from maps predominantly held at the scale adopted for England, Wales and Scotland in the 1840's. In 1854 the 1:2,500 scale was adopted for mapping urban areas and by 1896 it covered the whole of what were considered to be the cultivated parts of Great Britain. The published date given below is often some years later than the surveyed date. Before 1938, all OS maps were based on the Cassini Projection, with independent surveys of a single county or group of counties, giving rise to significant inaccuracies in outlying areas.

Map Name(s) and Date(s)

SK7982 1973 1:2,500	SK8082 1974 1:2,500
SK7981 1973 1:2,500	SK8081 1974 1:2,500

Historical Map - Segment A14

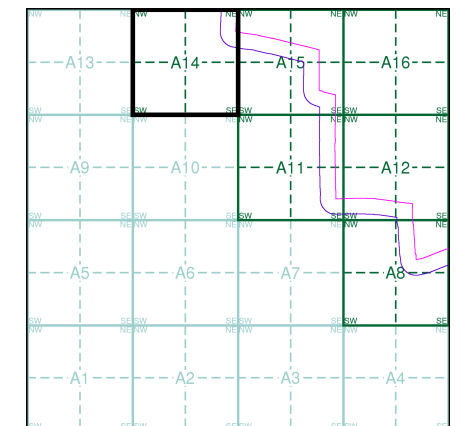

Order Details

Order Number: 298001706_1_1
 Customer Ref: 21-2098.04
 National Grid Reference: 480860, 381630
 Slice: A
 Site Area (Ha): 1355.61
 Search Buffer (m): 100

Site Details

West Barton 2

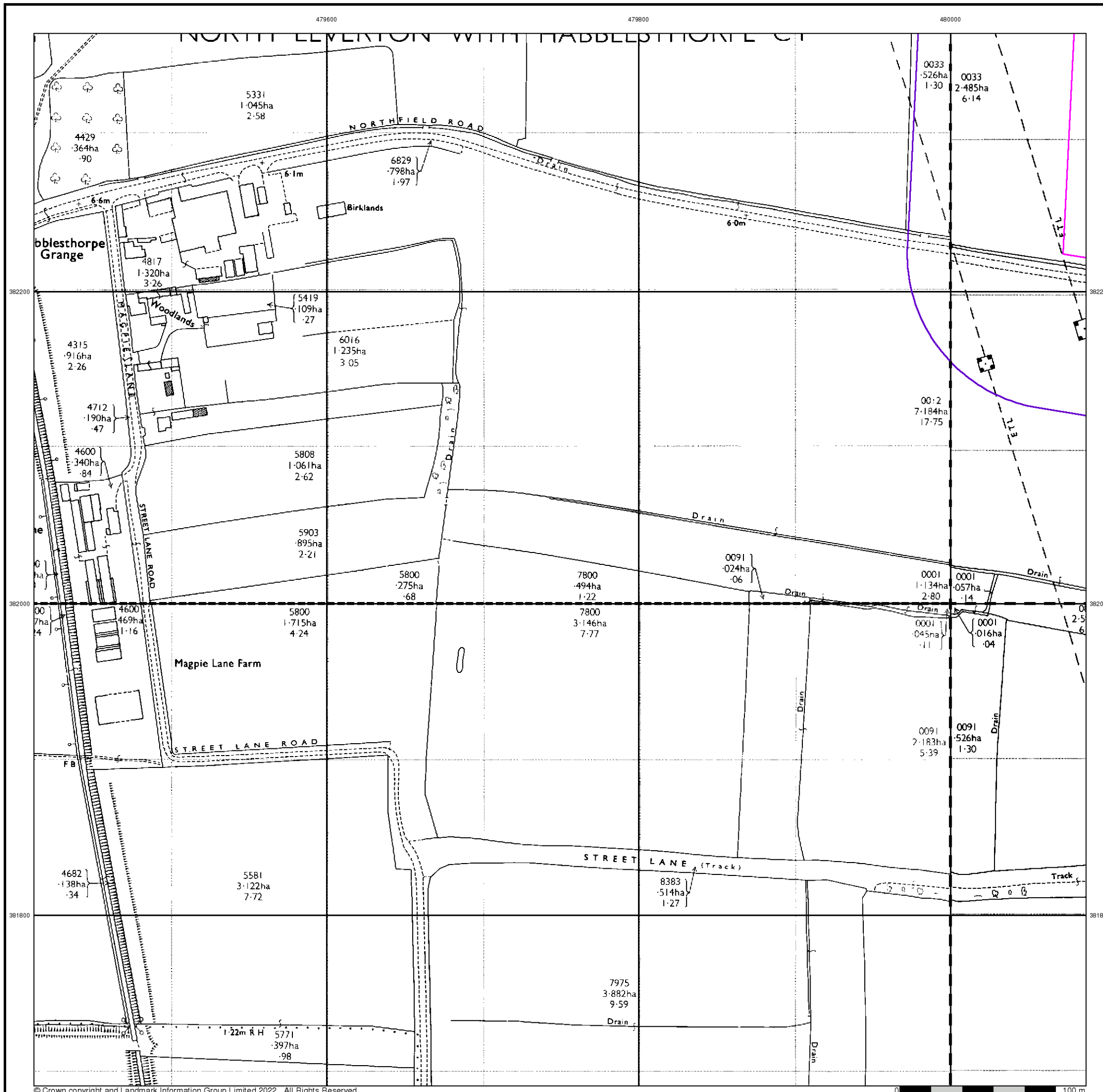

Ordnance Survey Plan

Published 1992

Source map scale - 1:2,500

The historical maps shown were reproduced from maps predominantly held at the scale adopted for England, Wales and Scotland in the 1840's. In 1854 the 1:2,500 scale was adopted for mapping urban areas and by 1896 it covered the whole of what were considered to be the cultivated parts of Great Britain. The published date given below is often some years later than the surveyed date. Before 1938, all OS maps were based on the Cassini Projection, with independent surveys of a single county or group of counties, giving rise to significant inaccuracies in outlying areas.

Map Name(s) and Date(s)

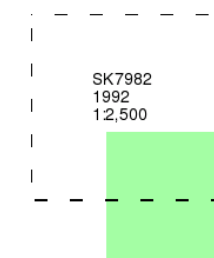

Historical Map - Segment A14

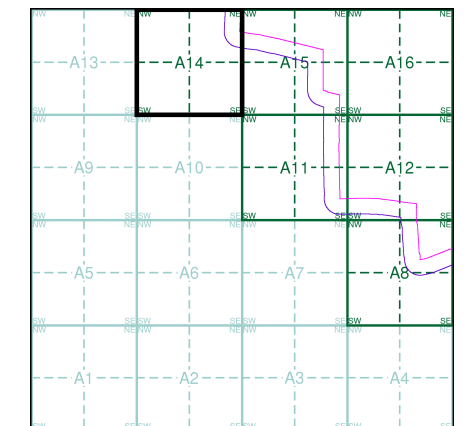

Order Details

Order Number: 298001706_1_1
 Customer Ref: 21-2098.04
 National Grid Reference: 480860, 381630
 Slice: A
 Site Area (Ha): 1355.61
 Search Buffer (m): 100

Site Details

West Barton 2



Large-Scale National Grid Data

Published 1994

Source map scale - 1:2,500

'Large Scale National Grid Data' superseded SIM cards (Ordnance Survey's 'Survey of Information on Microfilm') in 1992, and continued to be produced until 1999. These maps were the fore-runners of digital mapping and so provide detailed information on houses and roads, but tend to show less topographic features such as vegetation. These maps were produced at both 1:2,500 and 1:1,250 scales.

Map Name(s) and Date(s)

SK7982 1994 1:2,500	SK8082 1994 1:2,500
SK7981 1994 1:2,500	SK8081 1994 1:2,500

Historical Map - Segment A14

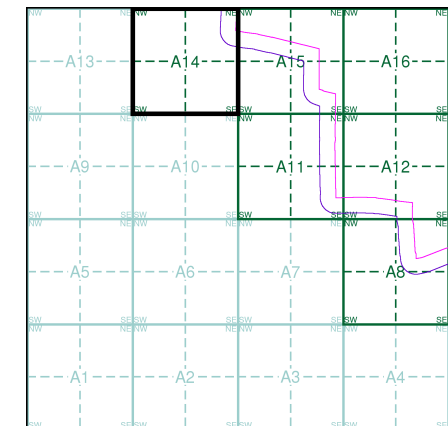

Order Details

Order Number: 298001706_1_1
 Customer Ref: 21-2098.04
 National Grid Reference: 480860, 381630
 Slice: A
 Site Area (Ha): 1355.61
 Search Buffer (m): 100

Site Details

West Barton 2



Historical Mapping Legends

Ordnance Survey County Series and Ordnance Survey Plan 1:2,500

Quarry **Gravel Pit** **Sand Pit**
Clay Pit **Shingle** **Refuse Heap**
Sloping Masonry **Flat Rock**
Marsh **Reeds** **Osiers**
Rough Pasture **Furze** **Wood**
Mixed Wood **Brushwood** **Orchard**
Fir **Ford** **Stepping Stones**
Ferry **Waterfall** **Lock**
Trig. Station **Altitude at Trig. Station**
B.M. 325.9 **Bench Mark** **Surface Level**
Arrow denotes flow of water **Antiquities (site of)**
Cutting **Embankment**
Railway crossing Road **Level Crossing** **Road crossing Railway**
Railway crossing River or Canal **Road over single stream** **Road over River or Canal**
County Boundary (Geographical)
County & Civil Parish Boundary
Administrative County & Civil Parish Boundary
County Borough Boundary (England)
Co. Boro. Bdy.
County Burgh Boundary (Scotland)
Boundary Post or Stone **Police Call Box**
B.R. Bridle Road **P Pump**
E.P. Electricity Pylon **S.P. Signal Post**
F.B. Foot Bridge **Sl. Sluice**
F.P. Foot Path **Sp. Spring**
G.P. Guide Post or Board **T.C.B. Telephone Call Box**
M.S. Mile Stone **Tr. Trough**
M.P. M.R. Mooring Post or Ring **W Well**

Ordnance Survey Plan, Additional SIMs and Supply of Unpublished Survey Information 1:2,500 and 1:1,250

Inactive Quarry, Chalk Pit or Clay Pit **Active Quarry, Chalk Pit or Clay Pit**
Rock **Boulders**
Cliff **Slopes** **Top**
Roofed Building **Glazed Roof Building**
Sloping Masonry **Archway**
Non-Coniferous Tree (surveyed) **Coniferous Tree (surveyed)**
Non-Coniferous Trees (not surveyed) **Coniferous Trees (not surveyed)**
Orchard Tree **Scrub** **Bracken**
Coppice, Osier **Reeds** **Marsh, Saltings**
Rough Grassland **Heath** **Culvert**
Direction of water flow **Bench Mark** **Antiquity (site of)**
Cave Entrance **Triangulation Station** **Electricity Pylon**
Electricity Transmission Line
County Boundary (Geographical)
County & Civil Parish Boundary
Civil Parish Boundary
Admin. County or County Bor. Boundary
London Borough Boundary
Symbol marking point where boundary mereing changes
Beer House **Pillar, Pole or Post**
Boundary Post or Stone **Post Office**
Capstan, Crane **Public Convenience**
Chimney **Public House**
Drinking Fountain **Pump**
Electricity Pillar or Post **Signal Box or Bridge**
Fire Alarm Pillar **Signal Post or Light**
Foot Bridge **Spring**
Guide Post **Tank or Track**
Hydrant or Hydraulic **Telephone Call Box**
Level Crossing **Telephone Call Post**
Manhole **Trough**
Mile Post or Mooring Post **Water Point, Water Tap**
Mile Stone **Well**
Normal Tidal Limit **Wind Pump**

Large-Scale National Grid Data 1:2,500 and 1:1,250

Cliff **Slopes** **Top**
Rock **Rock (scattered)**
Boulders **Boulders (scattered)**
Positioned Boulder **Scree**
Non-Coniferous Tree (surveyed) **Coniferous Tree (surveyed)**
Non-Coniferous Trees (not surveyed) **Coniferous Trees (not surveyed)**
Orchard Tree **Scrub** **Bracken**
Coppice, Osier **Reeds** **Marsh, Saltings**
Rough Grassland **Heath** **Culvert**
Direction of water flow **Triangulation Station** **Antiquity (site of)**
Electricity Transmission Line **Electricity Pylon**
Bench Mark **Buildings with Building Seed**
Roofed Building **Glazed Roof Building**
Civil parish/community boundary
District boundary
County boundary
Boundary post/stone
Boundary mereing symbol (note: these always appear in opposed pairs or groups of three)
Barracks **Pillar, Pole or Post**
Battery **Post Office**
Cemetery **Public Convenience**
Chimney **Pump**
Cistern **Pumping Station**
Dismtd Rly **Place of Worship**
Electricity Generating Station **Sewage Ppg Sta** **Sewage Pumping Station**
Electricity Pole, Pillar **Signal Box or Bridge**
Electricity Sub Station **Signal Post or Light**
Filter Bed **Spring**
Fountain / Drinking Ftn. **Tank or Track**
Gas Valve Compound **Trough**
Gas Governor **Wind Pump**
Guide Post **Water Point, Water Tap**
Manhole **Works (building or area)**
Mile Post or Mile Stone **Well**



Historical Mapping & Photography included:

Mapping Type	Scale	Date	Pg
Nottinghamshire	1:2,500	1886	2
Lincolnshire	1:2,500	1886	3
Nottinghamshire	1:2,500	1899	4
Lincolnshire	1:2,500	1920	5
Nottinghamshire	1:2,500	1920	6
Ordnance Survey Plan	1:2,500	1974	7
Large-Scale National Grid Data	1:2,500	1994	8

Historical Map - Segment A15

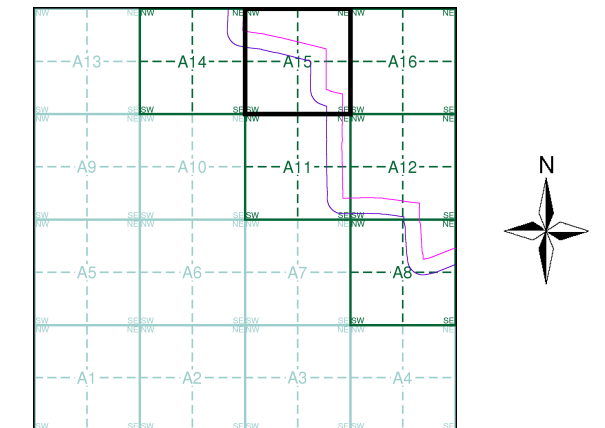

Order Details

Order Number: 298001706_1_1
 Customer Ref: 21-2098.04
 National Grid Reference: 480860, 381630
 Slice: A
 Site Area (Ha): 1355.61
 Search Buffer (m): 100

Site Details

West Barton 2



Tel: 0844 844 9952
 Fax: 0844 844 9951
 Web: [REDACTED]

480200

480400

480600

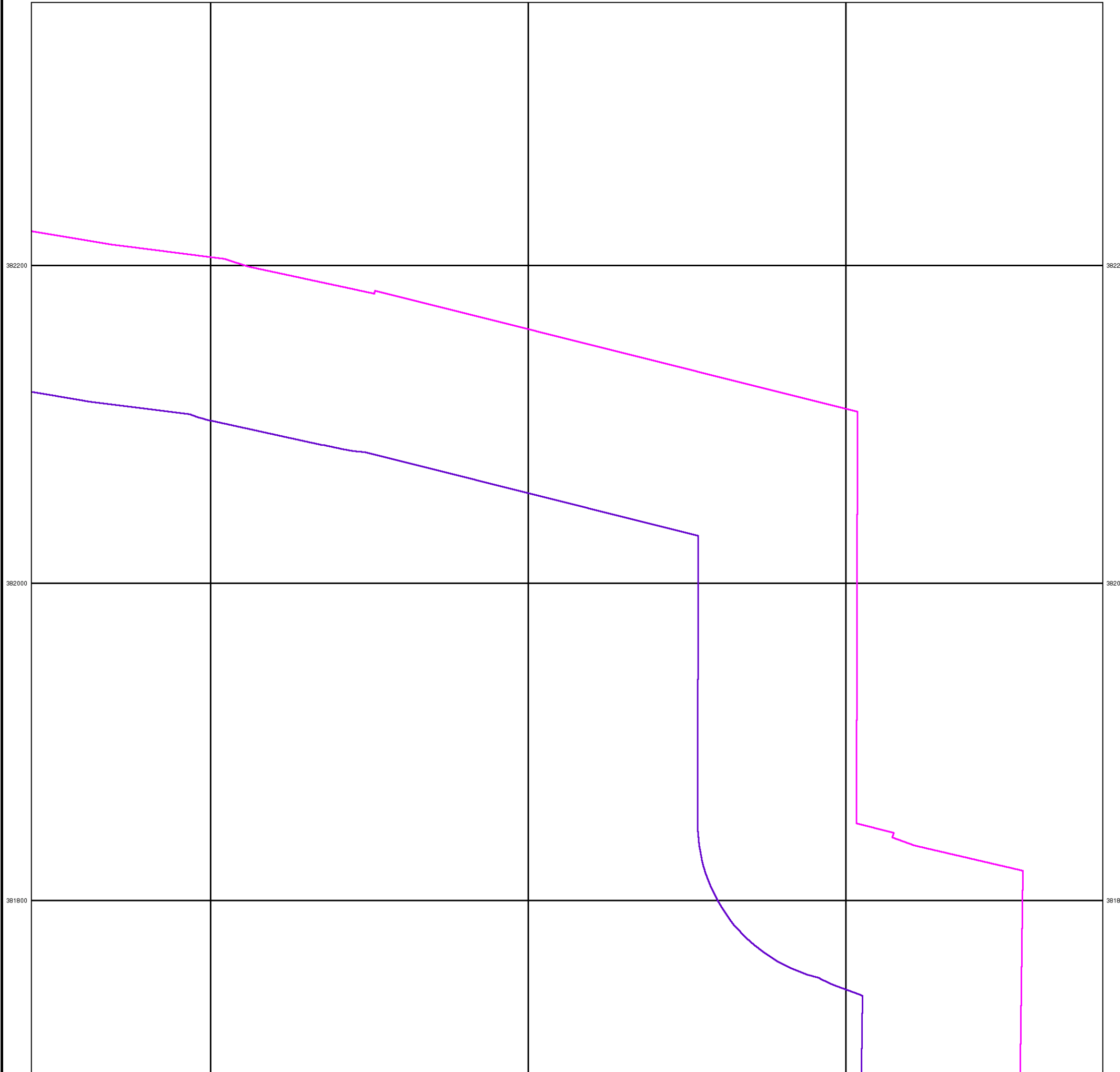

Nottinghamshire

Published 1886

Source map scale - 1:2,500

The historical maps shown were reproduced from maps predominantly held at the scale adopted for England, Wales and Scotland in the 1840's. In 1854 the 1:2,500 scale was adopted for mapping urban areas and by 1896 it covered the whole of what were considered to be the cultivated parts of Great Britain. The published date given below is often some years later than the surveyed date. Before 1938, all OS maps were based on the Cassini Projection, with independent surveys of a single county or group of counties, giving rise to significant inaccuracies in outlying areas.

Map Name(s) and Date(s)

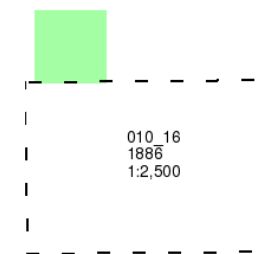

Historical Map - Segment A15

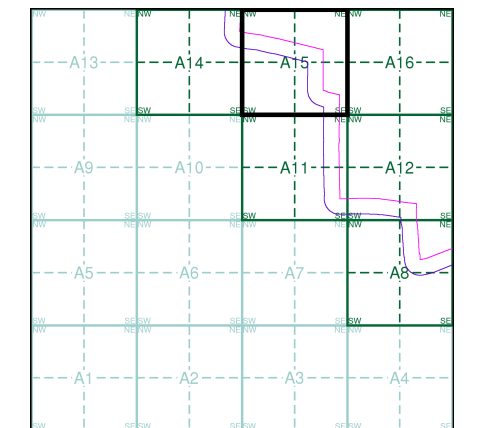

Order Details

Order Number: 298001706_1_1
 Customer Ref: 21-2098.04
 National Grid Reference: 480860, 381630
 Slice: A
 Site Area (Ha): 1355.61
 Search Buffer (m): 100

Site Details

West Barton 2



Tel: 0844 844 9952
 Fax: 0844 844 9951
 Web: [REDACTED]

Lincolnshire

Published 1886

Source map scale - 1:2,500

The historical maps shown were reproduced from maps predominantly held at the scale adopted for England, Wales and Scotland in the 1840's. In 1854 the 1:2,500 scale was adopted for mapping urban areas and by 1896 it covered the whole of what were considered to be the cultivated parts of Great Britain. The published date given below is often some years later than the surveyed date. Before 1938, all OS maps were based on the Cassini Projection, with independent surveys of a single county or group of counties, giving rise to significant inaccuracies in outlying areas.

Map Name(s) and Date(s)

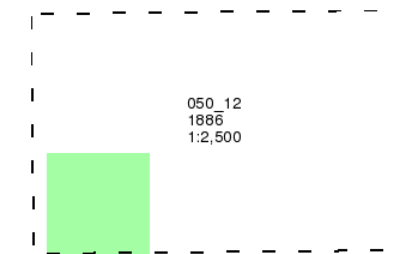

Historical Map - Segment A15

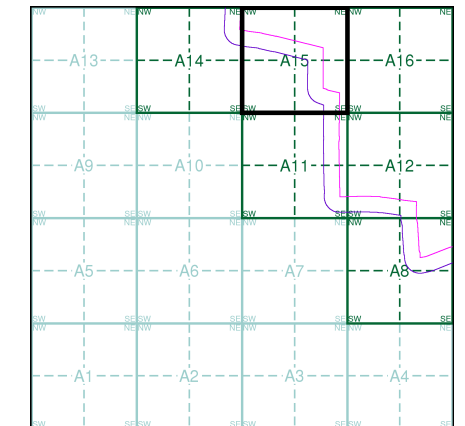

Order Details

Order Number: 298001706_1_1
 Customer Ref: 21-2098.04
 National Grid Reference: 480860, 381630
 Slice: A
 Site Area (Ha): 1355.61
 Search Buffer (m): 100

Site Details

West Barton 2

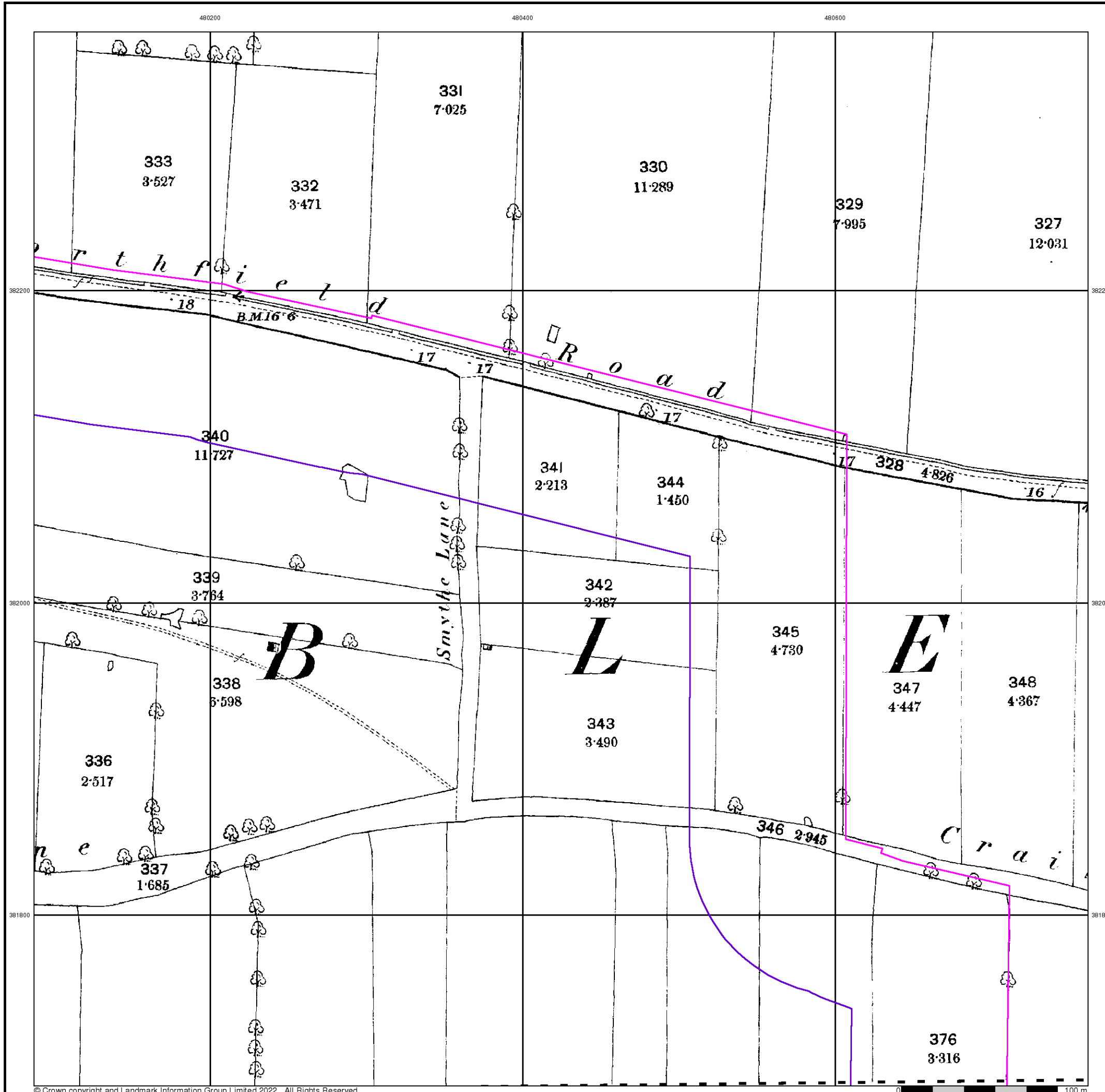

Nottinghamshire

Published 1899

Source map scale - 1:2,500

The historical maps shown were reproduced from maps predominantly held at the scale adopted for England, Wales and Scotland in the 1840's. In 1854 the 1:2,500 scale was adopted for mapping urban areas and by 1896 it covered the whole of what were considered to be the cultivated parts of Great Britain. The published date given below is often some years later than the surveyed date. Before 1938, all OS maps were based on the Cassini Projection, with independent surveys of a single county or group of counties, giving rise to significant inaccuracies in outlying areas.

Map Name(s) and Date(s)

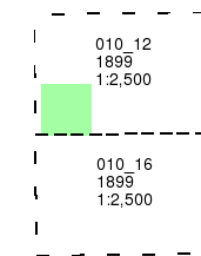

Historical Map - Segment A15

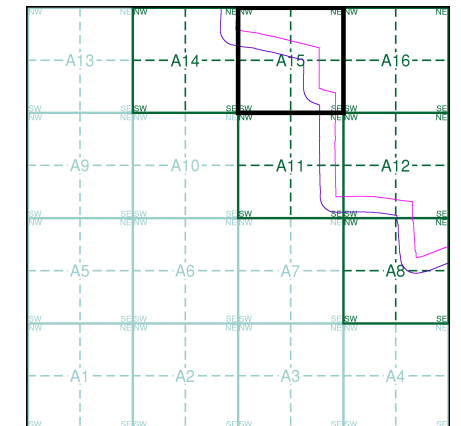

Order Details

Order Number: 298001706_1_1
 Customer Ref: 21-2098.04
 National Grid Reference: 480860, 381630
 Slice: A
 Site Area (Ha): 1355.61
 Search Buffer (m): 100

Site Details

West Barton 2



Lincolnshire

Published 1920

Source map scale - 1:2,500

The historical maps shown were reproduced from maps predominantly held at the scale adopted for England, Wales and Scotland in the 1840's. In 1854 the 1:2,500 scale was adopted for mapping urban areas and by 1896 it covered the whole of what were considered to be the cultivated parts of Great Britain. The published date given below is often some years later than the surveyed date. Before 1938, all OS maps were based on the Cassini Projection, with independent surveys of a single county or group of counties, giving rise to significant inaccuracies in outlying areas.

Map Name(s) and Date(s)

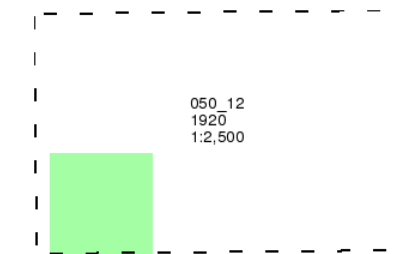

Historical Map - Segment A15

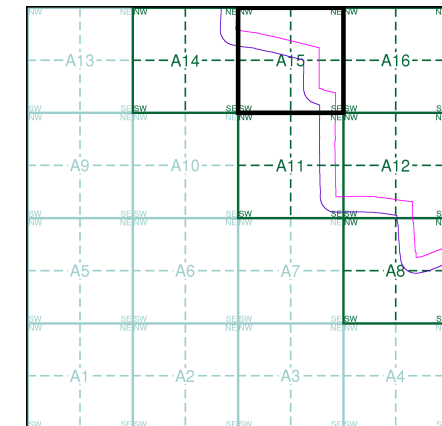

Order Details

Order Number: 298001706_1_1
 Customer Ref: 21-2098.04
 National Grid Reference: 480860, 381630
 Slice: A
 Site Area (Ha): 1355.61
 Search Buffer (m): 100

Site Details

West Barton 2

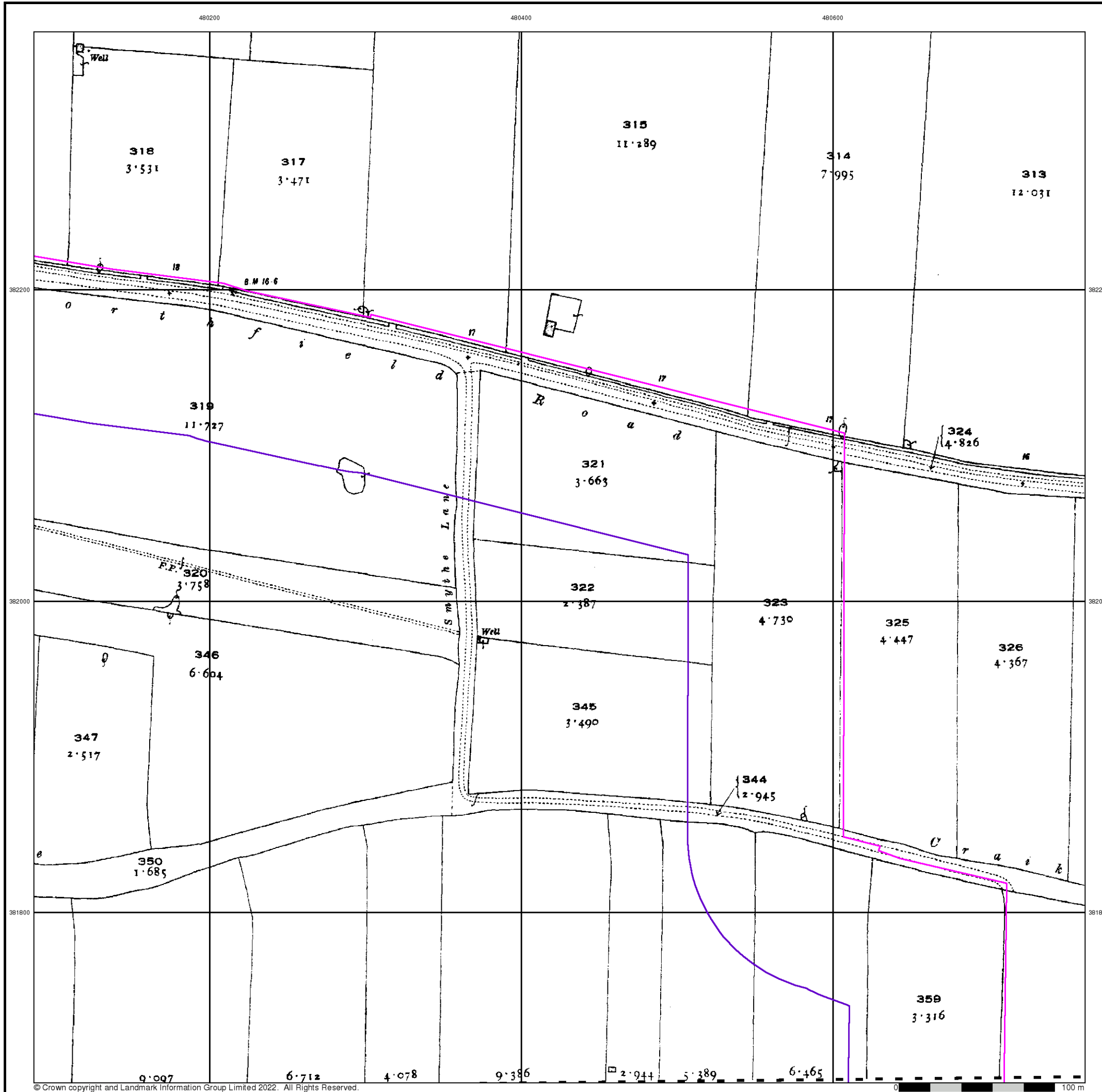

Nottinghamshire

Published 1920

Source map scale - 1:2,500

The historical maps shown were reproduced from maps predominantly held at the scale adopted for England, Wales and Scotland in the 1840's. In 1854 the 1:2,500 scale was adopted for mapping urban areas and by 1896 it covered the whole of what were considered to be the cultivated parts of Great Britain. The published date given below is often some years later than the surveyed date. Before 1938, all OS maps were based on the Cassini Projection, with independent surveys of a single county or group of counties, giving rise to significant inaccuracies in outlying areas.

Map Name(s) and Date(s)

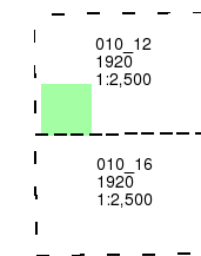

Historical Map - Segment A15

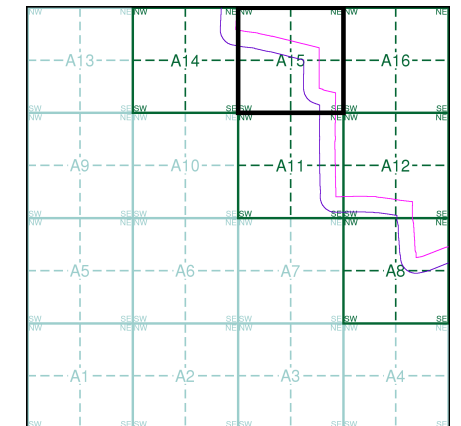

Order Details

Order Number: 298001706_1_1
 Customer Ref: 21-2098.04
 National Grid Reference: 480860, 381630
 Slice: A
 Site Area (Ha): 1355.61
 Search Buffer (m): 100

Site Details

West Barton 2



Ordnance Survey Plan

Published 1974

Source map scale - 1:2,500

The historical maps shown were reproduced from maps predominantly held at the scale adopted for England, Wales and Scotland in the 1840's. In 1854 the 1:2,500 scale was adopted for mapping urban areas and by 1896 it covered the whole of what were considered to be the cultivated parts of Great Britain. The published date given below is often some years later than the surveyed date. Before 1938, all OS maps were based on the Cassini Projection, with independent surveys of a single county or group of counties, giving rise to significant inaccuracies in outlying areas.

Map Name(s) and Date(s)

SK8082
1974
1:2,500
SK8081
1974
1:2,500

Historical Map - Segment A15

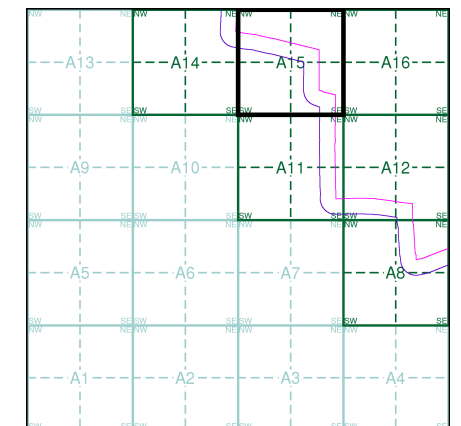

Order Details

Order Number: 298001706_1_1
 Customer Ref: 21-2098.04
 National Grid Reference: 480860, 381630
 Slice: A
 Site Area (Ha): 1355.61
 Search Buffer (m): 100

Site Details

West Barton 2

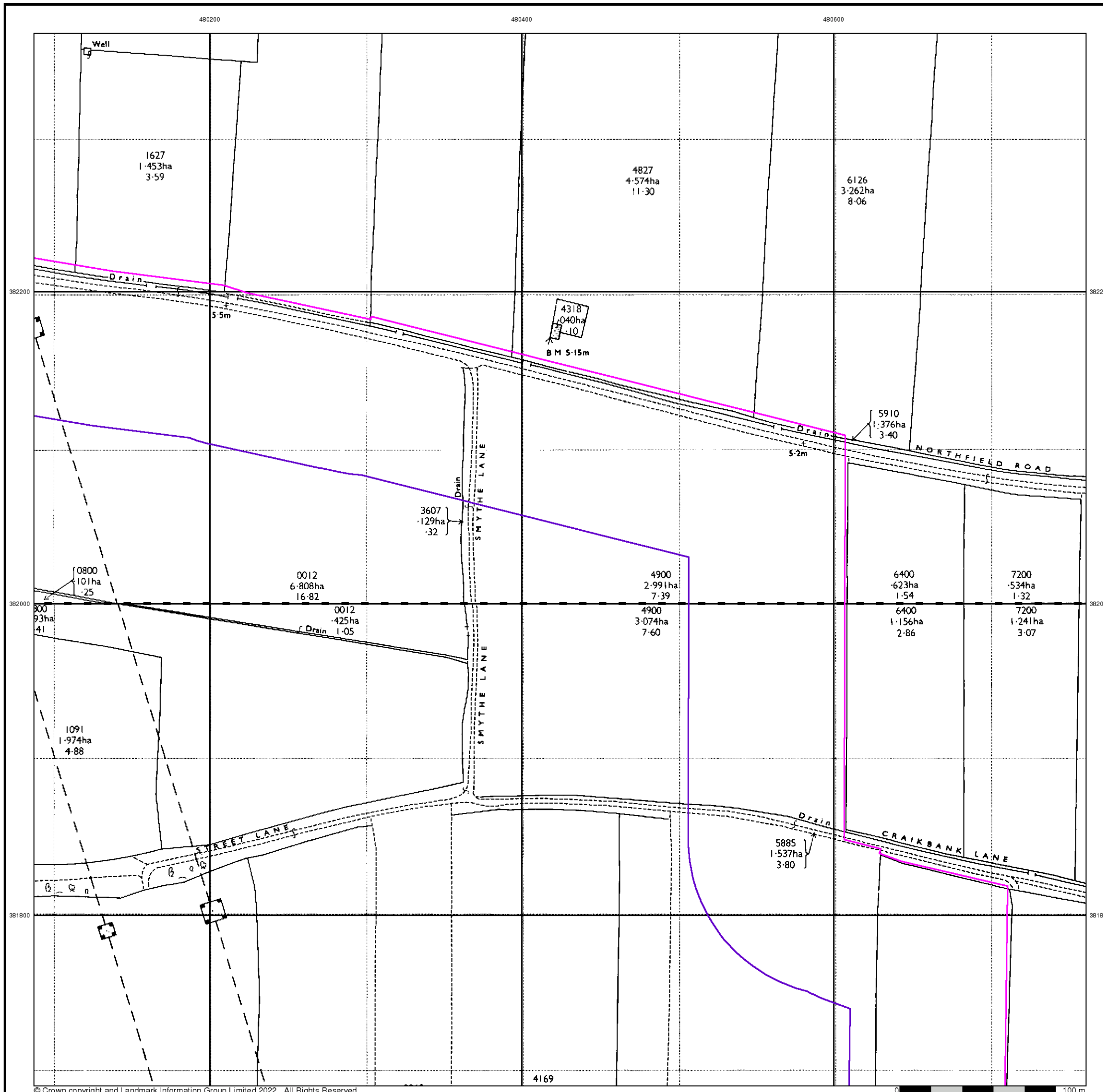

Large-Scale National Grid Data

Published 1994

Source map scale - 1:2,500

'Large Scale National Grid Data' superseded SIM cards (Ordnance Survey's 'Survey of Information on Microfilm') in 1992, and continued to be produced until 1999. These maps were the fore-runners of digital mapping and so provide detailed information on houses and roads, but tend to show less topographic features such as vegetation. These maps were produced at both 1:2,500 and 1:1,250 scales.

Map Name(s) and Date(s)

SK8082	1994	1:2,500
SK8081	1994	1:2,500

Historical Map - Segment A15

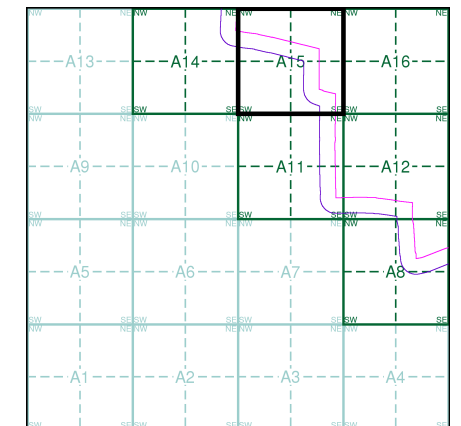

Order Details

Order Number: 298001706_1_1
 Customer Ref: 21-2098.04
 National Grid Reference: 480860, 381630
 Slice: A
 Site Area (Ha): 1355.61
 Search Buffer (m): 100

Site Details

West Barton 2

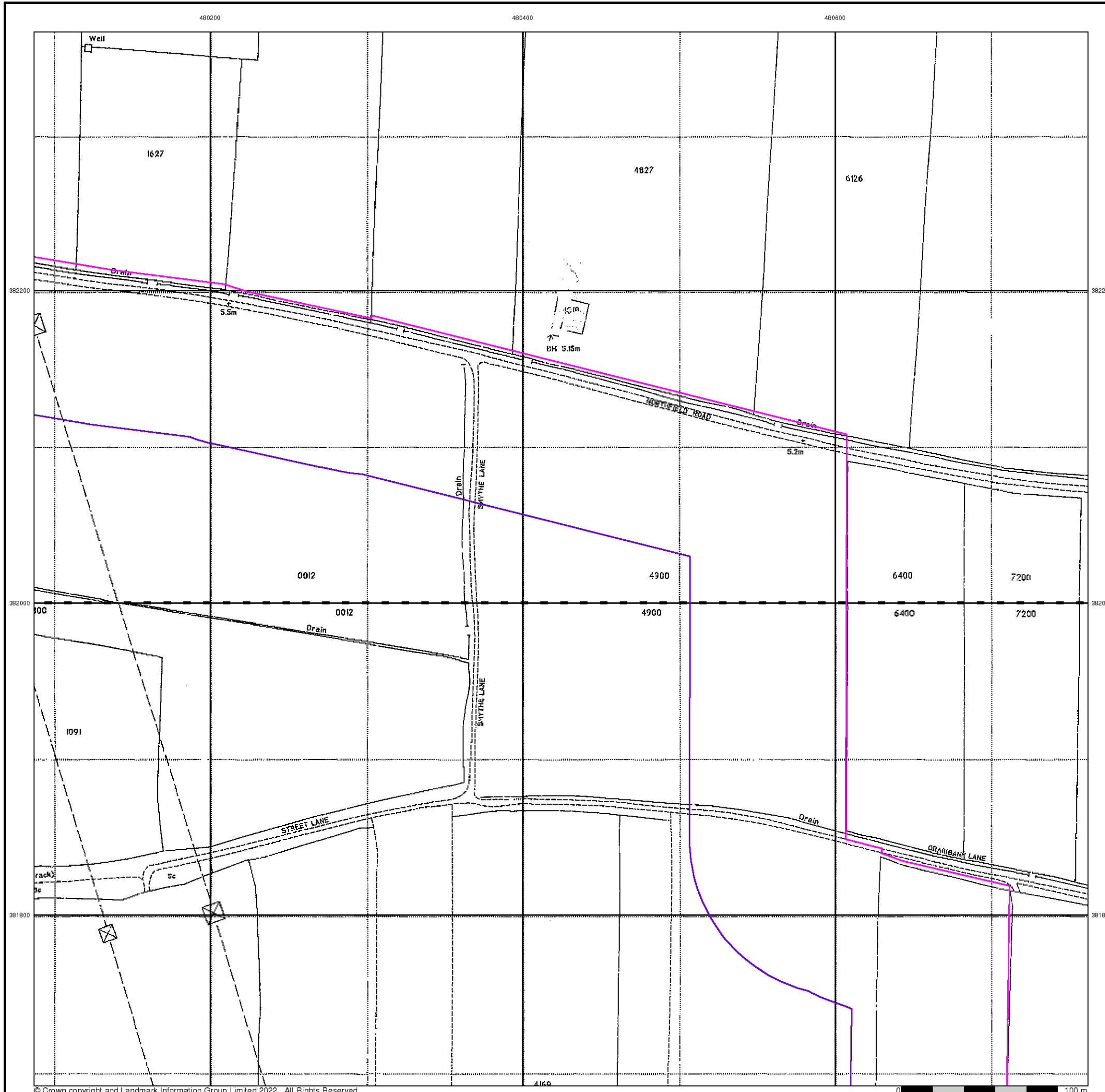

Lincolnshire

Published 1886

Source map scale - 1:2,500

The historical maps shown were reproduced from maps predominantly held at the scale adopted for England, Wales and Scotland in the 1840's. In 1854 the 1:2,500 scale was adopted for mapping urban areas and by 1896 it covered the whole of what were considered to be the cultivated parts of Great Britain. The published date given below is often some years later than the surveyed date. Before 1938, all OS maps were based on the Cassini Projection, with independent surveys of a single county or group of counties, giving rise to significant inaccuracies in outlying areas.

Map Name(s) and Date(s)

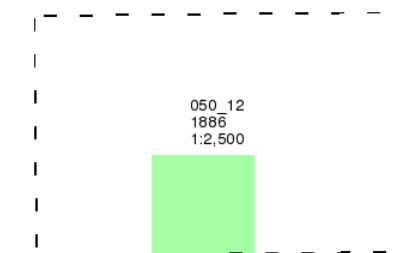

Historical Map - Segment A16

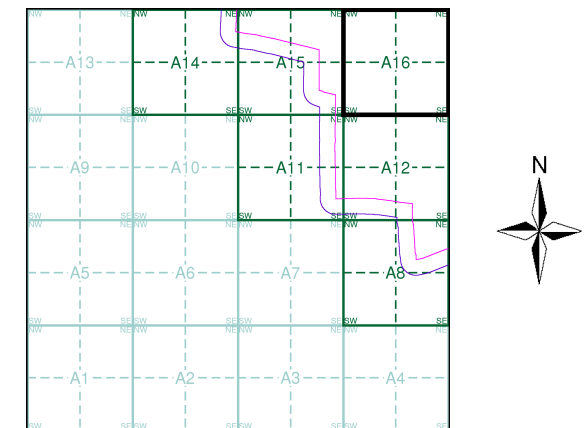

Order Details

Order Number: 298001706_1_1
 Customer Ref: 21-2098.04
 National Grid Reference: 480860, 381630
 Slice: A
 Site Area (Ha): 1355.61
 Search Buffer (m): 100

Site Details

West Barton 2

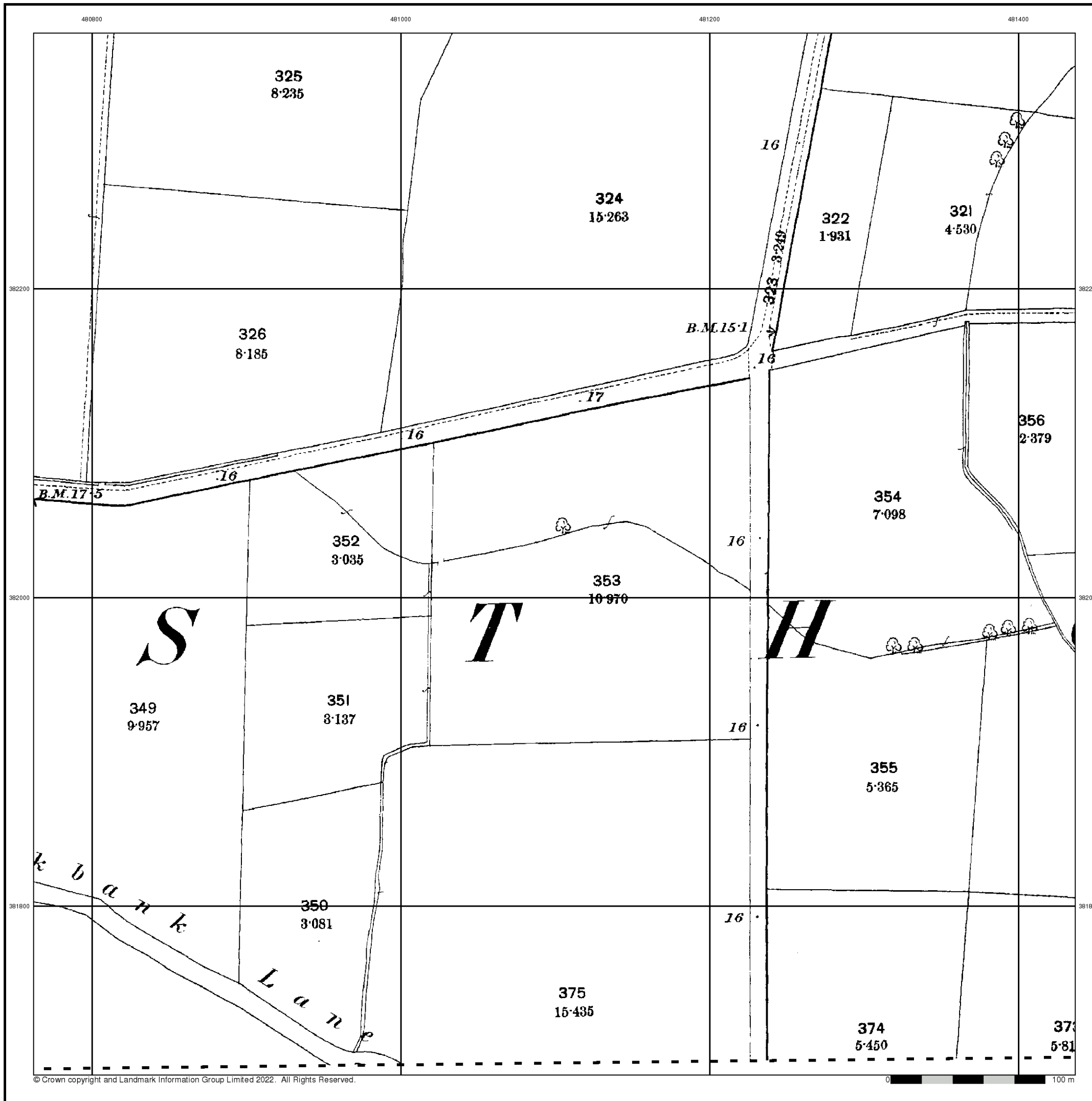

480800

481000

481200

481400

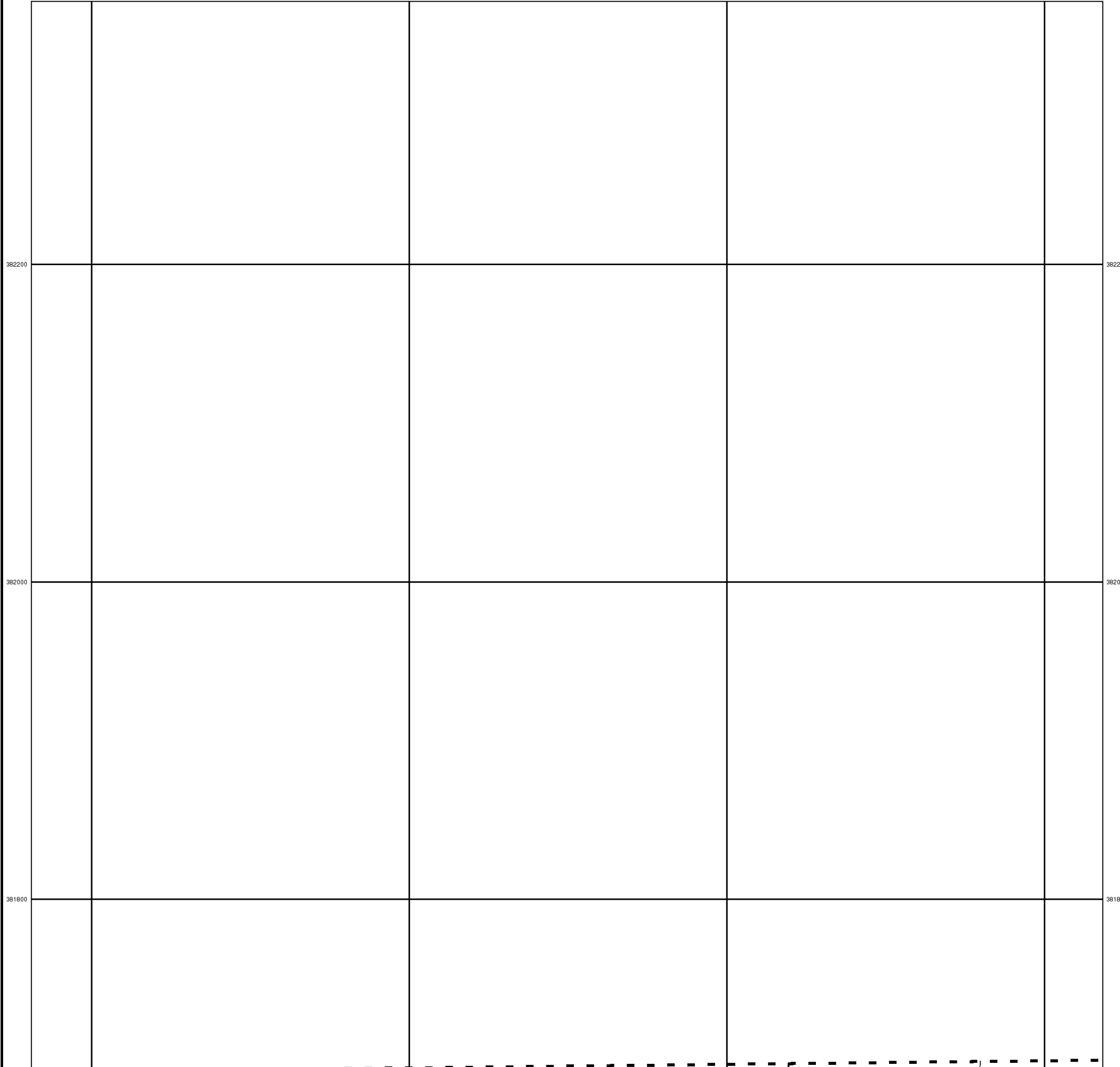

Nottinghamshire

Published 1886

Source map scale - 1:2,500

The historical maps shown were reproduced from maps predominantly held at the scale adopted for England, Wales and Scotland in the 1840's. In 1854 the 1:2,500 scale was adopted for mapping urban areas and by 1896 it covered the whole of what were considered to be the cultivated parts of Great Britain. The published date given below is often some years later than the surveyed date. Before 1938, all OS maps were based on the Cassini Projection, with independent surveys of a single county or group of counties, giving rise to significant inaccuracies in outlying areas.

Map Name(s) and Date(s)

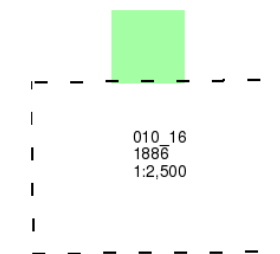

Historical Map - Segment A16

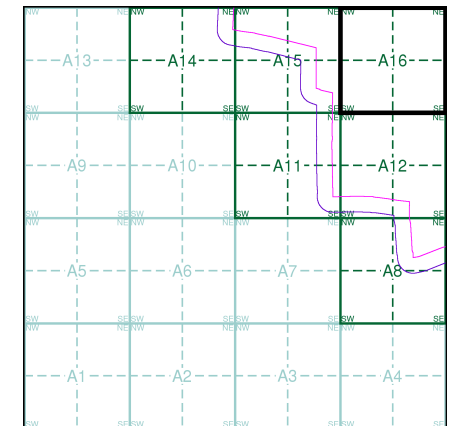

Order Details

Order Number: 298001706_1_1
 Customer Ref: 21-2098.04
 National Grid Reference: 480860, 381630
 Slice: A
 Site Area (Ha): 1355.61
 Search Buffer (m): 100

Site Details

West Barton 2



Tel: 0844 844 9952
 Fax: 0844 844 9951
 Web: [REDACTED]

Nottinghamshire

Published 1899

Source map scale - 1:2,500

The historical maps shown were reproduced from maps predominantly held at the scale adopted for England, Wales and Scotland in the 1840's. In 1854 the 1:2,500 scale was adopted for mapping urban areas and by 1896 it covered the whole of what were considered to be the cultivated parts of Great Britain. The published date given below is often some years later than the surveyed date. Before 1938, all OS maps were based on the Cassini Projection, with independent surveys of a single county or group of counties, giving rise to significant inaccuracies in outlying areas.

Map Name(s) and Date(s)

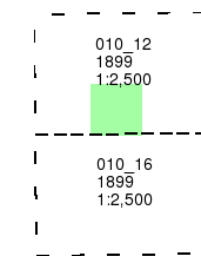

Historical Map - Segment A16

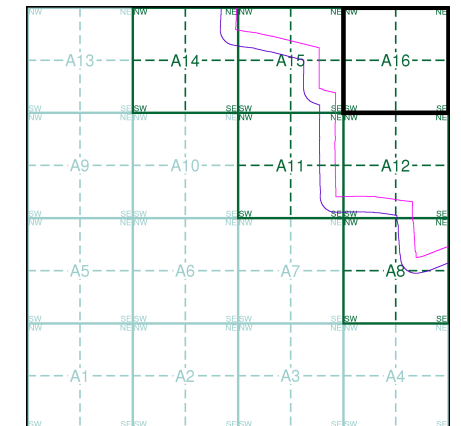

Order Details

Order Number: 298001706_1_1
 Customer Ref: 21-2098.04
 National Grid Reference: 480860, 381630
 Slice: A
 Site Area (Ha): 1355.61
 Search Buffer (m): 100

Site Details

West Barton 2



Nottinghamshire

Published 1920

Source map scale - 1:2,500

The historical maps shown were reproduced from maps predominantly held at the scale adopted for England, Wales and Scotland in the 1840's. In 1854 the 1:2,500 scale was adopted for mapping urban areas and by 1896 it covered the whole of what were considered to be the cultivated parts of Great Britain. The published date given below is often some years later than the surveyed date. Before 1938, all OS maps were based on the Cassini Projection, with independent surveys of a single county or group of counties, giving rise to significant inaccuracies in outlying areas.

Map Name(s) and Date(s)

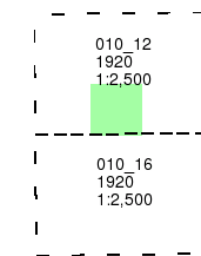

Historical Map - Segment A16

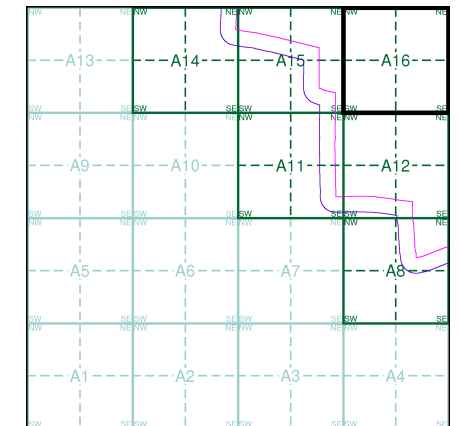

Order Details

Order Number: 298001706_1_1
 Customer Ref: 21-2098.04
 National Grid Reference: 480860, 381630
 Slice: A
 Site Area (Ha): 1355.61
 Search Buffer (m): 100

Site Details

West Barton 2



Lincolnshire

Published 1920

Source map scale - 1:2,500

The historical maps shown were reproduced from maps predominantly held at the scale adopted for England, Wales and Scotland in the 1840's. In 1854 the 1:2,500 scale was adopted for mapping urban areas and by 1896 it covered the whole of what were considered to be the cultivated parts of Great Britain. The published date given below is often some years later than the surveyed date. Before 1938, all OS maps were based on the Cassini Projection, with independent surveys of a single county or group of counties, giving rise to significant inaccuracies in outlying areas.

Map Name(s) and Date(s)

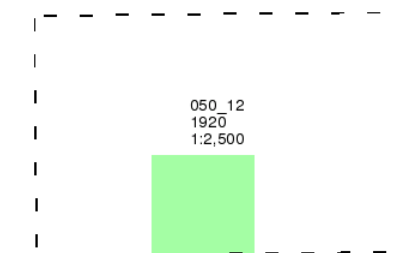

Historical Map - Segment A16

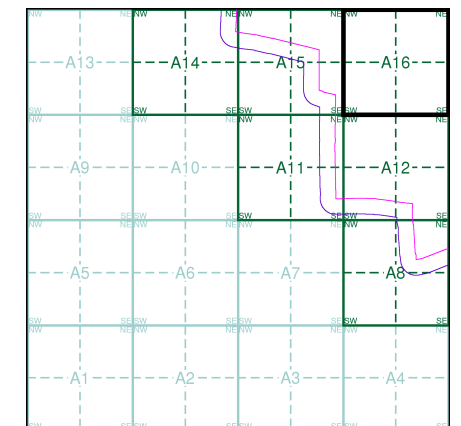

Order Details

Order Number: 298001706_1_1
 Customer Ref: 21-2098.04
 National Grid Reference: 480860, 381630
 Slice: A
 Site Area (Ha): 1355.61
 Search Buffer (m): 100

Site Details

West Barton 2



Ordnance Survey Plan

Published 1974

Source map scale - 1:2,500

The historical maps shown were reproduced from maps predominantly held at the scale adopted for England, Wales and Scotland in the 1840's. In 1854 the 1:2,500 scale was adopted for mapping urban areas and by 1896 it covered the whole of what were considered to be the cultivated parts of Great Britain. The published date given below is often some years later than the surveyed date. Before 1938, all OS maps were based on the Cassini Projection, with independent surveys of a single county or group of counties, giving rise to significant inaccuracies in outlying areas.

Map Name(s) and Date(s)

SK8082 1974 12,500	SK8182 1974 12,500
SK8081 1974 12,500	SK8181 1974 12,500

Historical Map - Segment A16

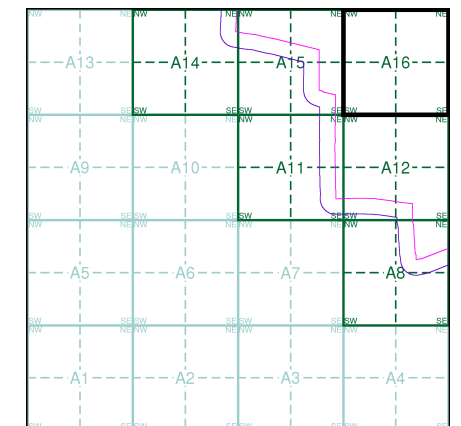

Order Details

Order Number: 298001706_1_1
 Customer Ref: 21-2098.04
 National Grid Reference: 480860, 381630
 Slice: A
 Site Area (Ha): 1355.61
 Search Buffer (m): 100

Site Details

West Barton 2



Large-Scale National Grid Data

Published 1994

Source map scale - 1:2,500

'Large Scale National Grid Data' superseded SIM cards (Ordnance Survey's 'Survey of Information on Microfilm') in 1992, and continued to be produced until 1999. These maps were the fore-runners of digital mapping and so provide detailed information on houses and roads, but tend to show less topographic features such as vegetation. These maps were produced at both 1:2,500 and 1:1,250 scales.

Map Name(s) and Date(s)

SK8082	SK8182
1994	1994
12,500	12,500
SK8081	SK8181
1994	1994
12,500	12,500

Historical Map - Segment A16

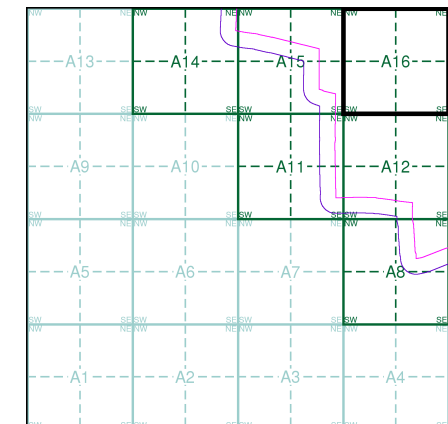

Order Details

Order Number: 298001706_1_1
 Customer Ref: 21-2098.04
 National Grid Reference: 480860, 381630
 Slice: A
 Site Area (Ha): 1355.61
 Search Buffer (m): 100

Site Details

West Barton 2



Historical Mapping Legends

Ordnance Survey County Series 1:10,560

- Gravel Pit
- Sand Pit
- Other Pits
- Quarry
- Shingle
- Orchard
- Osiers
- Reeds
- Marsh
- Mixed Wood
- Deciduous
- Brushwood
- Fir
- Furze
- Rough Pasture
- Arrow denotes flow of water
- Trigonometrical Station
- Site of Antiquities
- Bench Mark
- Pump, Guide Post, Signal Post
- Well, Spring, Boundary Post
- 285 Surface Level
- Sketched Contour
- Instrumental Contour
- Main Roads (Fenced/Un-Fenced)
- Minor Roads (Fenced/Un-Fenced)
- Sunken Road
- Raised Road
- Road over Railway
- Railway over River
- Railway over Road
- Level Crossing
- Road over River or Canal
- Road over Stream
- Road over Stream
- County Boundary (Geographical)
- County & Civil Parish Boundary
- Administrative County & Civil Parish Boundary
- County Borough Boundary (England)
- County Burgh Boundary (Scotland)
- Rural District Boundary
- Civil Parish Boundary

Ordnance Survey Plan 1:10,000

- Chalk Pit, Clay Pit or Quarry
- Gravel Pit
- Sand Pit
- Disused Pit or Quarry
- Refuse or Slag Heap
- Lake, Loch or Pond
- Dunes
- Boulders
- Coniferous Trees
- Non-Coniferous Trees
- Orchard
- Scrub
- Coppice
- Bracken
- Heath
- Rough Grassland
- Marsh
- Reeds
- Saltings
- Building
- Glasshouse
- Direction of Flow of Water
- Shingle
- Sand
- Sloping Masonry
- Pylon
- Electricity Transmission Line
- Pole
- Cutting
- Embankment
- Standard Gauge Multiple Track
- Standard Gauge Single Track
- Siding, Tramway or Mineral Line
- Narrow Gauge
- Geographical County
- Administrative County, County Borough or County of City
- Municipal Borough, Urban or Rural District, Burgh or District Council
- Borough, Burgh or County Constituency (Shown only when not coincident with other boundaries)
- Civil Parish (Shown alternately when coincidence of boundaries occurs)
- BP, BS Boundary Post or Stone
- Ch Church
- CH Club House
- F E Sta Fire Engine Station
- FB Foot Bridge
- Fn Fountain
- GP Guide Post
- MP Mile Post
- MS Mile Stone
- Pol Sta Police Station
- PO Post Office
- PC Public Convenience
- PH Public House
- SB Signal Box
- Spr Spring
- TCB Telephone Call Box
- TCP Telephone Call Post
- W Well

1:10,000 Raster Mapping

- Gravel Pit
- Refuse tip or slag heap
- Rock
- Rock (scattered)
- Boulders
- Boulders (scattered)
- Shingle
- Mud
- Mud
- Sand
- Sand Pit
- Slopes
- Top of cliff
- General detail
- Underground detail
- Overhead detail
- Narrow gauge railway
- Multi-track railway
- Single track railway
- County boundary (England only)
- Civil, parish or community boundary
- District, Unitary, Metropolitan, London Borough boundary
- Constituency boundary
- Area of wooded vegetation
- Non-coniferous trees
- Non-coniferous trees (scattered)
- Coniferous trees
- Coniferous trees (scattered)
- Positioned tree
- Orchard
- Coppice or Osiers
- Rough Grassland
- Heath
- Scrub
- Marsh, Salt Marsh or Reeds
- Water feature
- Flow arrows
- MHW(S) Mean high water (springs)
- MLW(S) Mean low water (springs)
- Telephone line (where shown)
- Electricity transmission line (with poles)
- Bench mark (where shown)
- Triangulation station
- Point feature (e.g. Guide Post or Mile Stone)
- Pylon, flare stack or lighting tower
- Site of (antiquity)
- Glasshouse
- General Building
- Important Building



Historical Mapping & Photography included:

Mapping Type	Scale	Date	Pg
Lincolnshire	1:10,560	1885	2
Nottinghamshire	1:10,560	1885	3
Nottinghamshire	1:10,560	1900	4
Lincolnshire	1:10,560	1906	5
Lincolnshire	1:10,560	1921 - 1922	6
Lincolnshire	1:10,560	1922	7
Lincolnshire	1:10,560	1947	8
Ordnance Survey Plan	1:10,000	1956	9
Ordnance Survey Plan	1:10,000	1974	10
Ordnance Survey Plan	1:10,000	1980	11
10K Raster Mapping	1:10,000	2000	12
Street View	Variable		13

Historical Map - Slice B

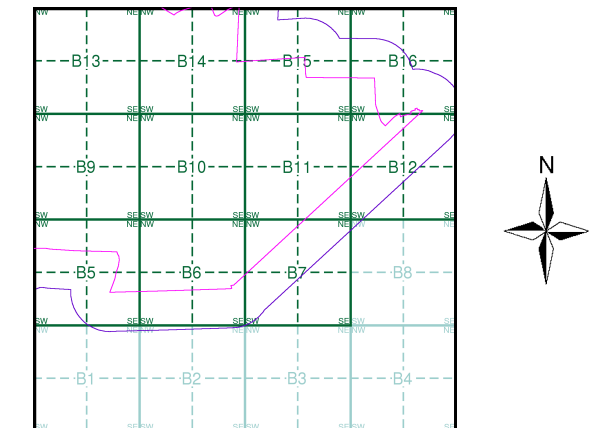

Order Details

Order Number: 298001706_1_1
 Customer Ref: 21-2098.04
 National Grid Reference: 482570, 381420
 Slice: B
 Site Area (Ha): 1355.61
 Search Buffer (m): 250

Site Details

West Barton 2



Tel: 0844 844 9952
 Fax: 0844 844 9951
 Web: [REDACTED]

Lincolnshire

Published 1885

Source map scale - 1:10,560

The historical maps shown were reproduced from maps predominantly held at the scale adopted for England, Wales and Scotland in the 1840's. In 1854 the 1:2,500 scale was adopted for mapping urban areas; these maps were used to update the 1:10,560 maps. The published date given therefore is often some years later than the surveyed date. Before 1938, all OS maps were based on the Cassini Projection, with independent surveys of a single county or group of counties, giving rise to significant inaccuracies in outlying areas. In the late 1940's, a Provisional Edition was produced, which updated the 1:10,560 mapping from a number of sources. The maps appear unfinished - with all military camps and other strategic sites removed. These maps were initially overprinted with the National Grid. In 1970, the first 1:10,000 maps were produced using the Transverse Mercator Projection. The revision process continued until recently, with new editions appearing every 10 years or so for urban areas.

Map Name(s) and Date(s)

051SW	1885	1:10,560
060NW	1885	1:10,560

Historical Map - Slice B

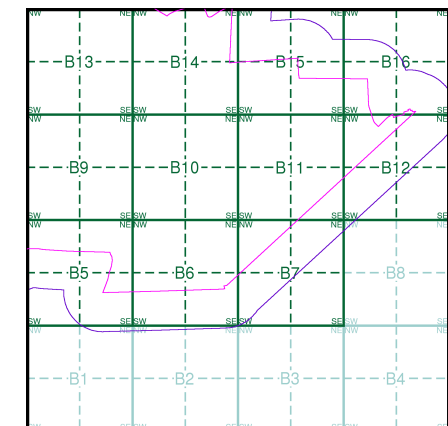

Order Details

Order Number: 298001706_1_1
 Customer Ref: 21-2098.04
 National Grid Reference: 482570, 381420
 Slice: B
 Site Area (Ha): 1355.61
 Search Buffer (m): 250

Site Details

West Barton 2

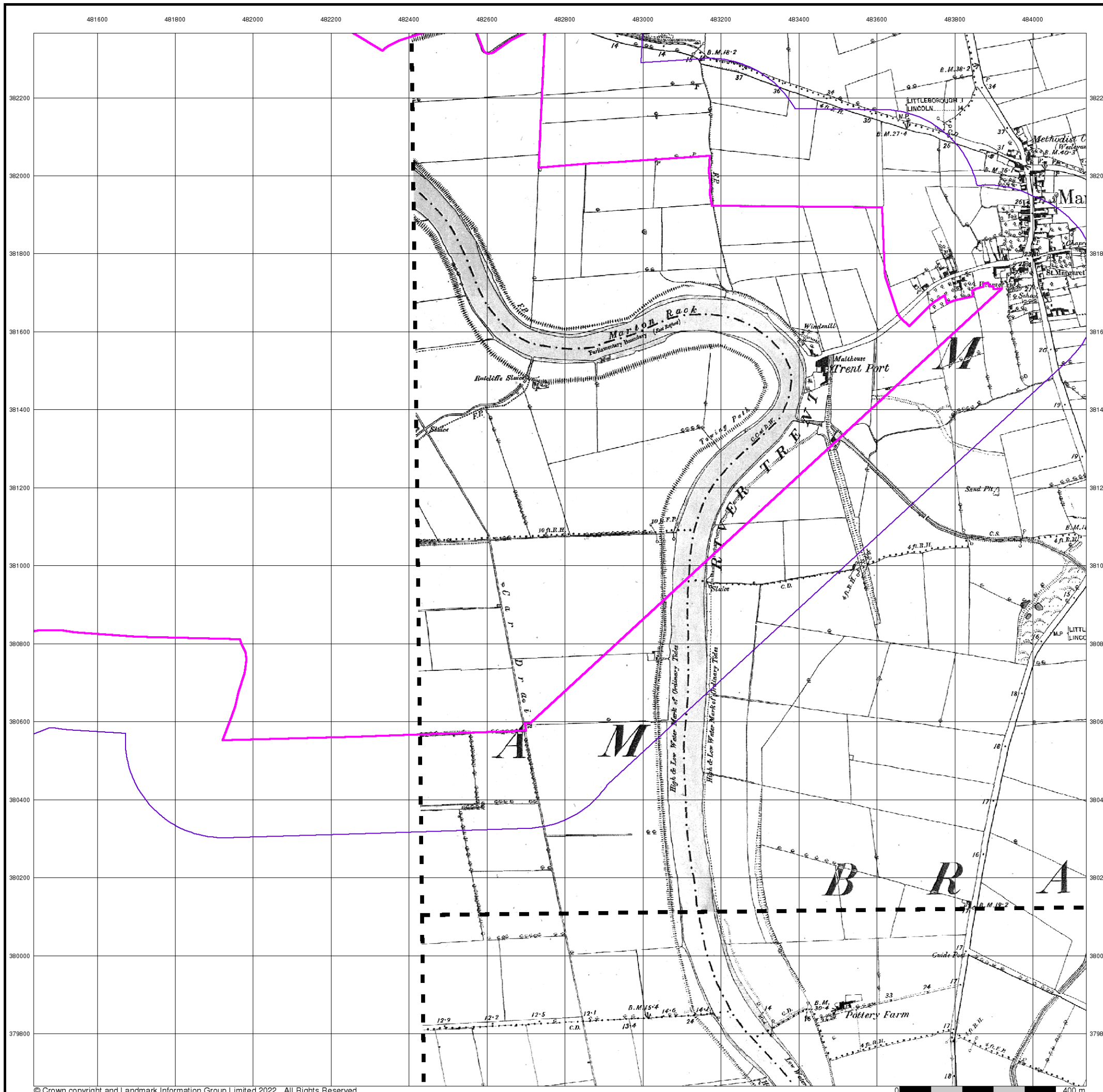

Nottinghamshire

Published 1885

Source map scale - 1:10,560

The historical maps shown were reproduced from maps predominantly held at the scale adopted for England, Wales and Scotland in the 1840's. In 1854 the 1:2,500 scale was adopted for mapping urban areas; these maps were used to update the 1:10,560 maps. The published date given therefore is often some years later than the surveyed date. Before 1938, all OS maps were based on the Cassini Projection, with independent surveys of a single county or group of counties, giving rise to significant inaccuracies in outlying areas. In the late 1940's, a Provisional Edition was produced, which updated the 1:10,560 mapping from a number of sources. The maps appear unfinished - with all military camps and other strategic sites removed. These maps were initially overprinted with the National Grid. In 1970, the first 1:10,000 maps were produced using the Transverse Mercator Projection. The revision process continued until recently, with new editions appearing every 10 years or so for urban areas.

Map Name(s) and Date(s)

010SE	1885	1:10,560
015NE	1885	1:10,560

Historical Map - Slice B

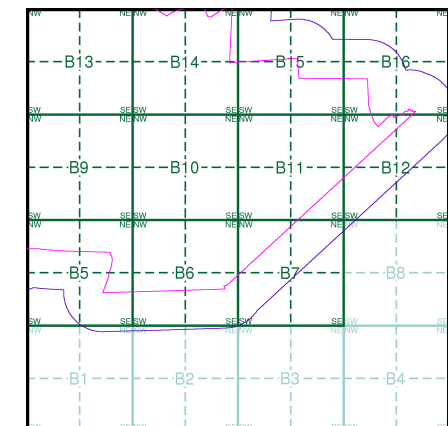

Order Details

Order Number: 298001706_1_1
 Customer Ref: 21-2098.04
 National Grid Reference: 482570, 381420
 Slice: B
 Site Area (Ha): 1355.61
 Search Buffer (m): 250

Site Details

West Barton 2



Nottinghamshire

Published 1900

Source map scale - 1:10,560

The historical maps shown were reproduced from maps predominantly held at the scale adopted for England, Wales and Scotland in the 1840's. In 1854 the 1:2,500 scale was adopted for mapping urban areas; these maps were used to update the 1:10,560 maps. The published date given therefore is often some years later than the surveyed date. Before 1938, all OS maps were based on the Cassini Projection, with independent surveys of a single county or group of counties, giving rise to significant inaccuracies in outlying areas. In the late 1940's, a Provisional Edition was produced, which updated the 1:10,560 mapping from a number of sources. The maps appear unfinished - with all military camps and other strategic sites removed. These maps were initially overprinted with the National Grid. In 1970, the first 1:10,000 maps were produced using the Transverse Mercator Projection. The revision process continued until recently, with new editions appearing every 10 years or so for urban areas.

Map Name(s) and Date(s)

010SE 1900 1:10,560	011SW 1900 1:10,560
015NE 1900 1:10,560	016NW 1900 1:10,560

Historical Map - Slice B

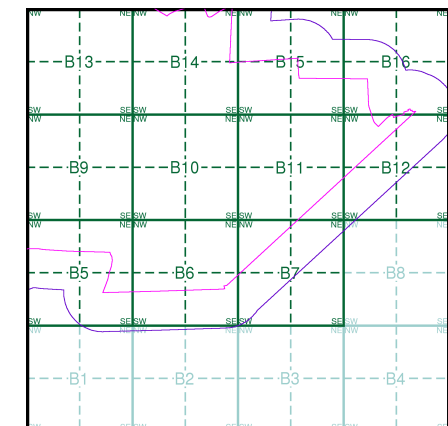

Order Details

Order Number: 298001706_1_1
 Customer Ref: 21-2098.04
 National Grid Reference: 482570, 381420
 Slice: B
 Site Area (Ha): 1355.61
 Search Buffer (m): 250

Site Details

West Barton 2

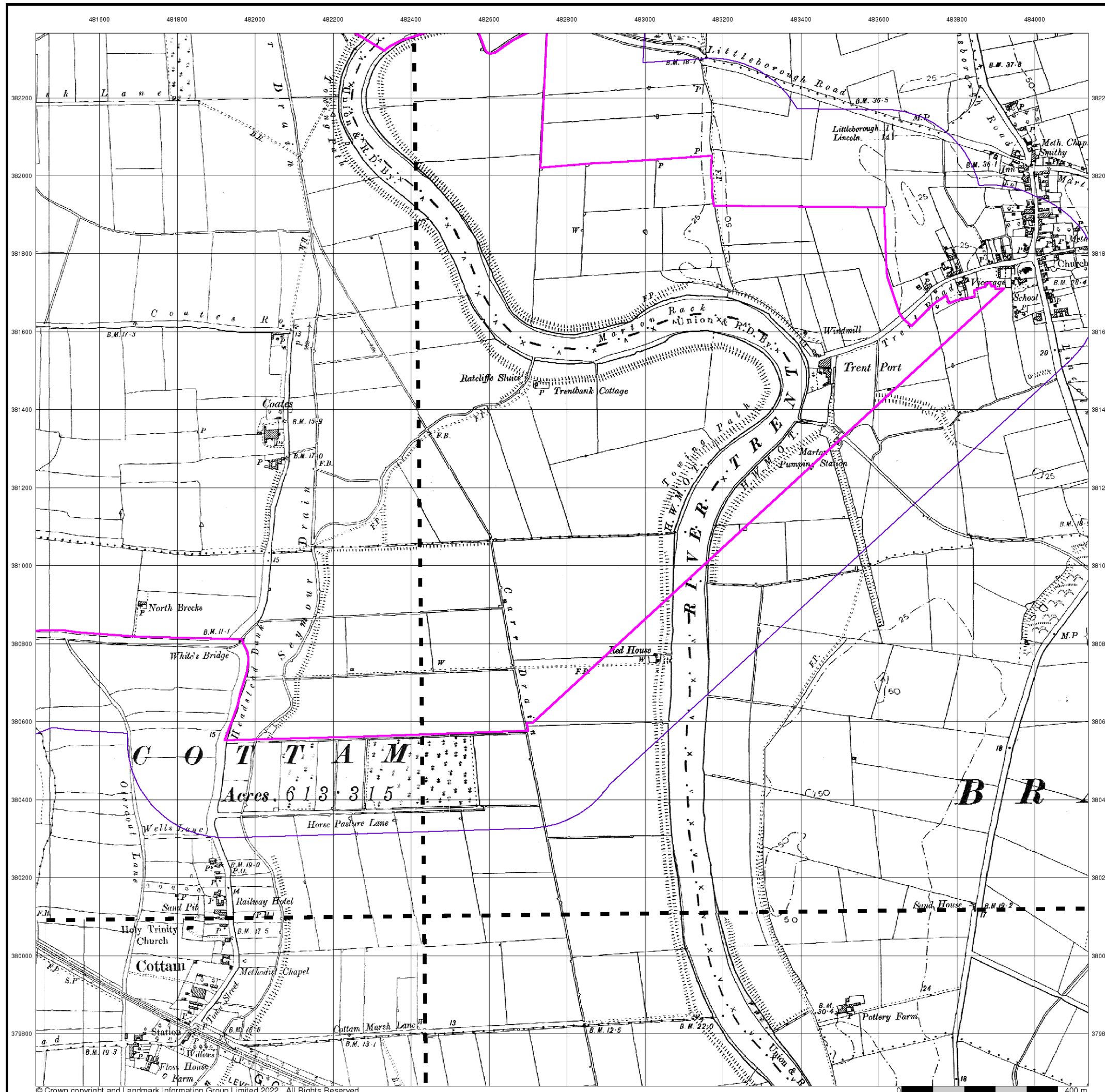

Lincolnshire

Published 1906

Source map scale - 1:10,560

The historical maps shown were reproduced from maps predominantly held at the scale adopted for England, Wales and Scotland in the 1840's. In 1854 the 1:2,500 scale was adopted for mapping urban areas; these maps were used to update the 1:10,560 maps. The published date given therefore is often some years later than the surveyed date. Before 1938, all OS maps were based on the Cassini Projection, with independent surveys of a single county or group of counties, giving rise to significant inaccuracies in outlying areas. In the late 1940's, a Provisional Edition was produced, which updated the 1:10,560 mapping from a number of sources. The maps appear unfinished - with all military camps and other strategic sites removed. These maps were initially overprinted with the National Grid. In 1970, the first 1:10,000 maps were produced using the Transverse Mercator Projection. The revision process continued until recently, with new editions appearing every 10 years or so for urban areas.

Map Name(s) and Date(s)

051SW	1906	1:10,560
060NW	1906	1:10,560

Historical Map - Slice B

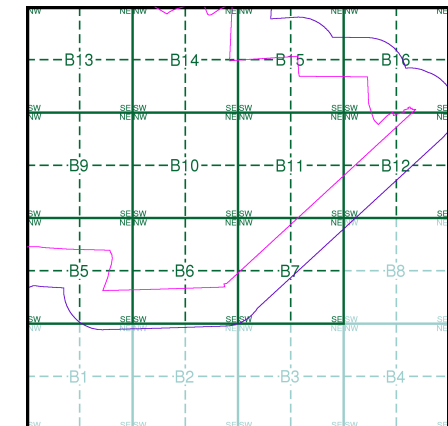

Order Details

Order Number: 298001706_1_1
 Customer Ref: 21-2098.04
 National Grid Reference: 482570, 381420
 Slice: B
 Site Area (Ha): 1355.61
 Search Buffer (m): 250

Site Details

West Barton 2

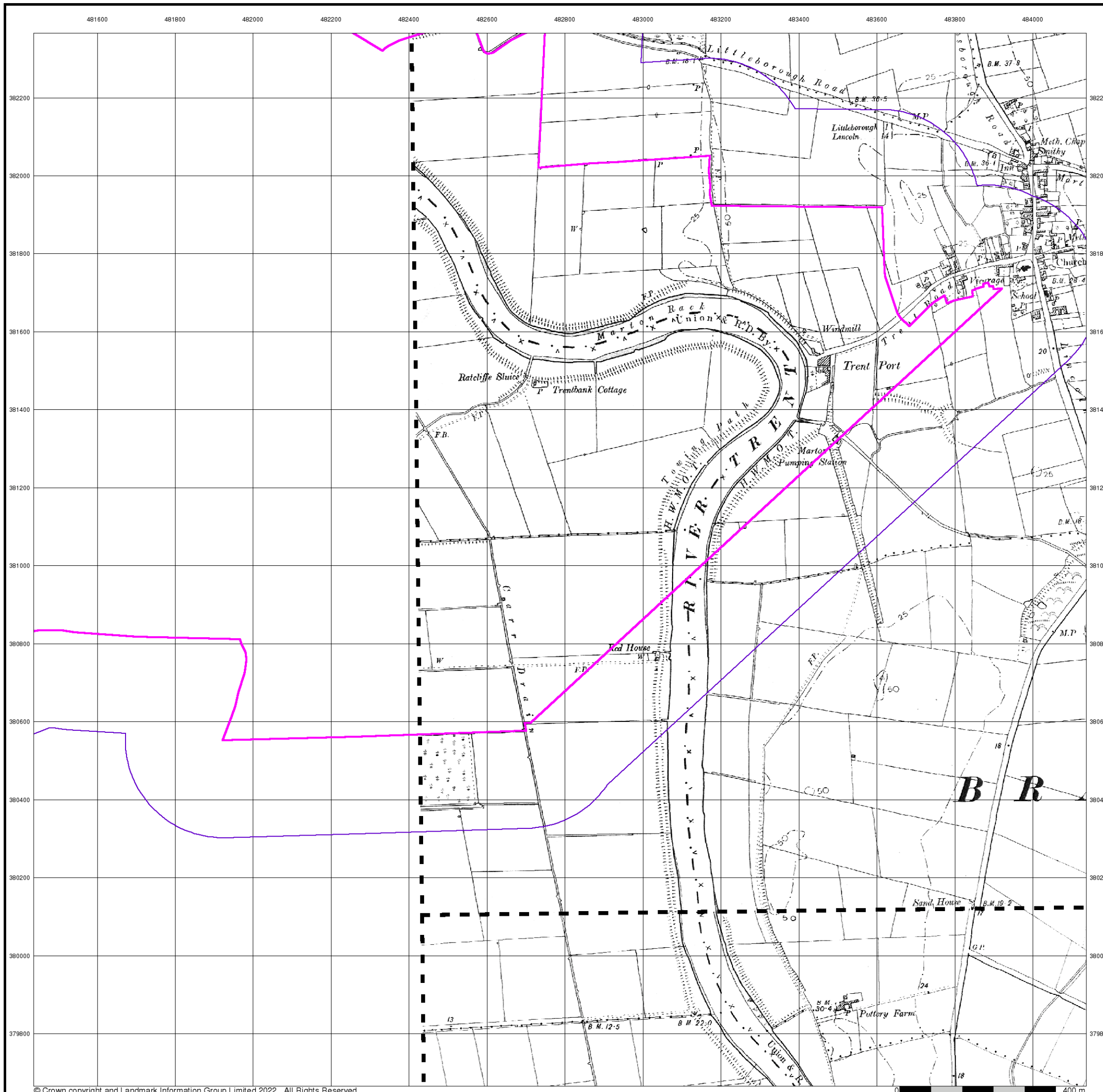

Lincolnshire

Published 1921 - 1922

Source map scale - 1:10,560

The historical maps shown were reproduced from maps predominantly held at the scale adopted for England, Wales and Scotland in the 1840's. In 1854 the 1:2,500 scale was adopted for mapping urban areas; these maps were used to update the 1:10,560 maps. The published date given therefore is often some years later than the surveyed date. Before 1938, all OS maps were based on the Cassini Projection, with independent surveys of a single county or group of counties, giving rise to significant inaccuracies in outlying areas. In the late 1940's, a Provisional Edition was produced, which updated the 1:10,560 mapping from a number of sources. The maps appear unfinished - with all military camps and other strategic sites removed. These maps were initially overprinted with the National Grid. In 1970, the first 1:10,000 maps were produced using the Transverse Mercator Projection. The revision process continued until recently, with new editions appearing every 10 years or so for urban areas.

Map Name(s) and Date(s)

050SE 1922 1:10,560	051SW 1922 1:10,560
059NE 1921 1:10,560	060NW 1922 1:10,560

Historical Map - Slice B

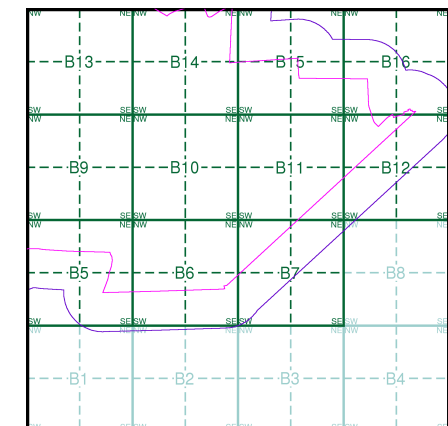

Order Details

Order Number: 298001706_1_1
 Customer Ref: 21-2098.04
 National Grid Reference: 482570, 381420
 Slice: B
 Site Area (Ha): 1355.61
 Search Buffer (m): 250

Site Details

West Barton 2

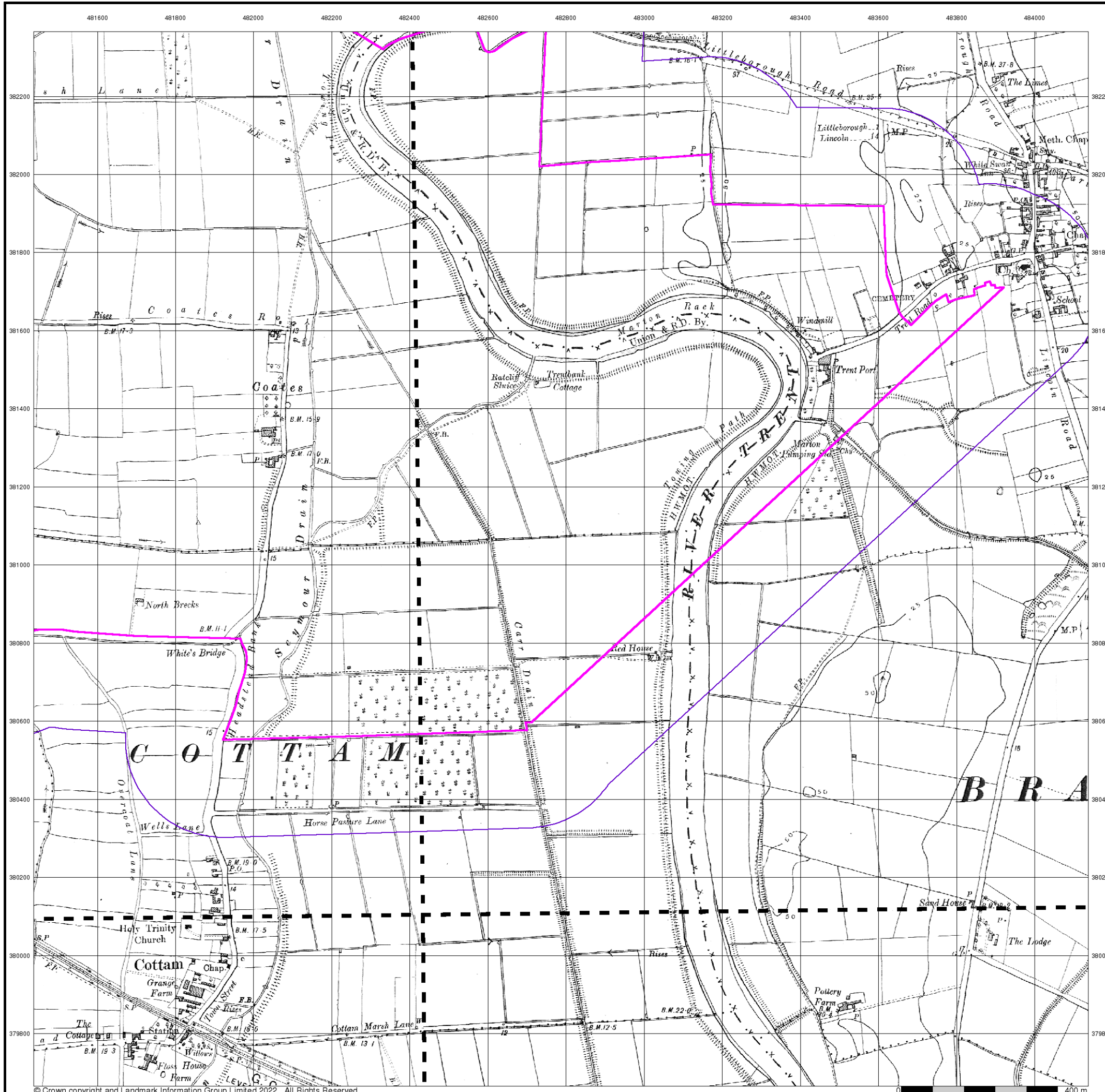

Lincolnshire

Published 1922

Source map scale - 1:10,560

The historical maps shown were reproduced from maps predominantly held at the scale adopted for England, Wales and Scotland in the 1840's. In 1854 the 1:2,500 scale was adopted for mapping urban areas; these maps were used to update the 1:10,560 maps. The published date given therefore is often some years later than the surveyed date. Before 1938, all OS maps were based on the Cassini Projection, with independent surveys of a single county or group of counties, giving rise to significant inaccuracies in outlying areas. In the late 1940's, a Provisional Edition was produced, which updated the 1:10,560 mapping from a number of sources. The maps appear unfinished - with all military camps and other strategic sites removed. These maps were initially overprinted with the National Grid. In 1970, the first 1:10,000 maps were produced using the Transverse Mercator Projection. The revision process continued until recently, with new editions appearing every 10 years or so for urban areas.

Map Name(s) and Date(s)

051SW	1922	1:10,560
060NW	1922	1:10,560

Historical Map - Slice B

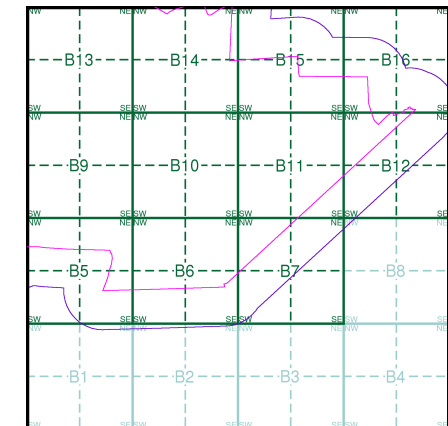

Order Details

Order Number: 298001706_1_1
 Customer Ref: 21-2098.04
 National Grid Reference: 482570, 381420
 Slice: B
 Site Area (Ha): 1355.61
 Search Buffer (m): 250

Site Details

West Barton 2

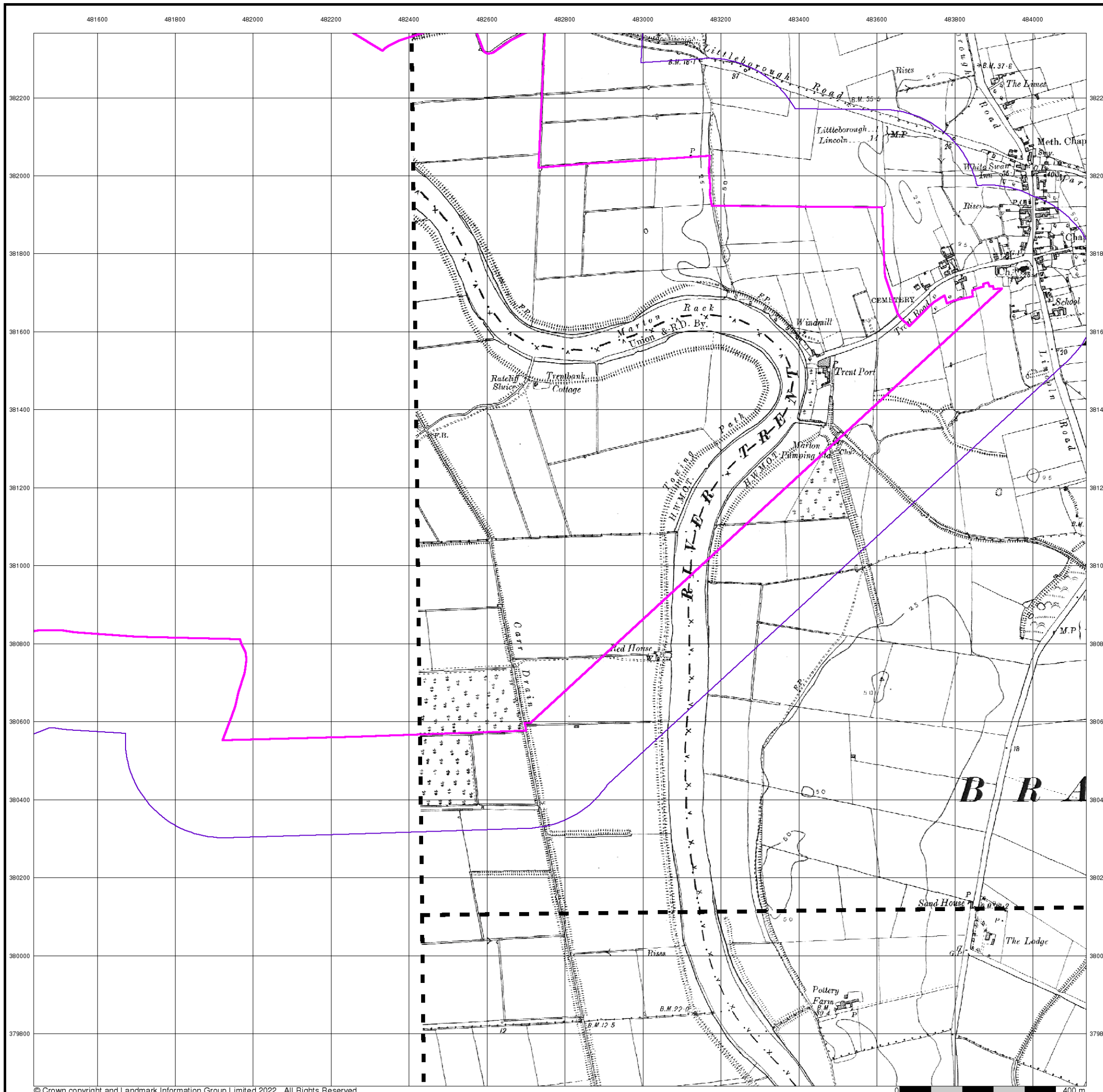

Lincolnshire

Published 1947

Source map scale - 1:10,560

The historical maps shown were reproduced from maps predominantly held at the scale adopted for England, Wales and Scotland in the 1840's. In 1854 the 1:2,500 scale was adopted for mapping urban areas; these maps were used to update the 1:10,560 maps. The published date given therefore is often some years later than the surveyed date. Before 1938, all OS maps were based on the Cassini Projection, with independent surveys of a single county or group of counties, giving rise to significant inaccuracies in outlying areas. In the late 1940's, a Provisional Edition was produced, which updated the 1:10,560 mapping from a number of sources. The maps appear unfinished - with all military camps and other strategic sites removed. These maps were initially overprinted with the National Grid. In 1970, the first 1:10,000 maps were produced using the Transverse Mercator Projection. The revision process continued until recently, with new editions appearing every 10 years or so for urban areas.

Map Name(s) and Date(s)

050SE 1947 1:10,560	051SW 1947 1:10,560
059NE 1947 1:10,560	060NW 1947 1:10,560

Historical Map - Slice B

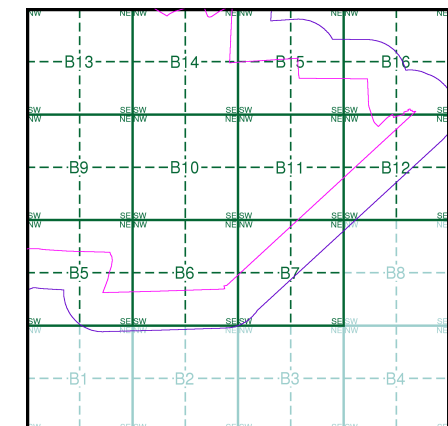

Order Details

Order Number: 298001706_1_1
 Customer Ref: 21-2098.04
 National Grid Reference: 482570, 381420
 Slice: B
 Site Area (Ha): 1355.61
 Search Buffer (m): 250

Site Details

West Barton 2

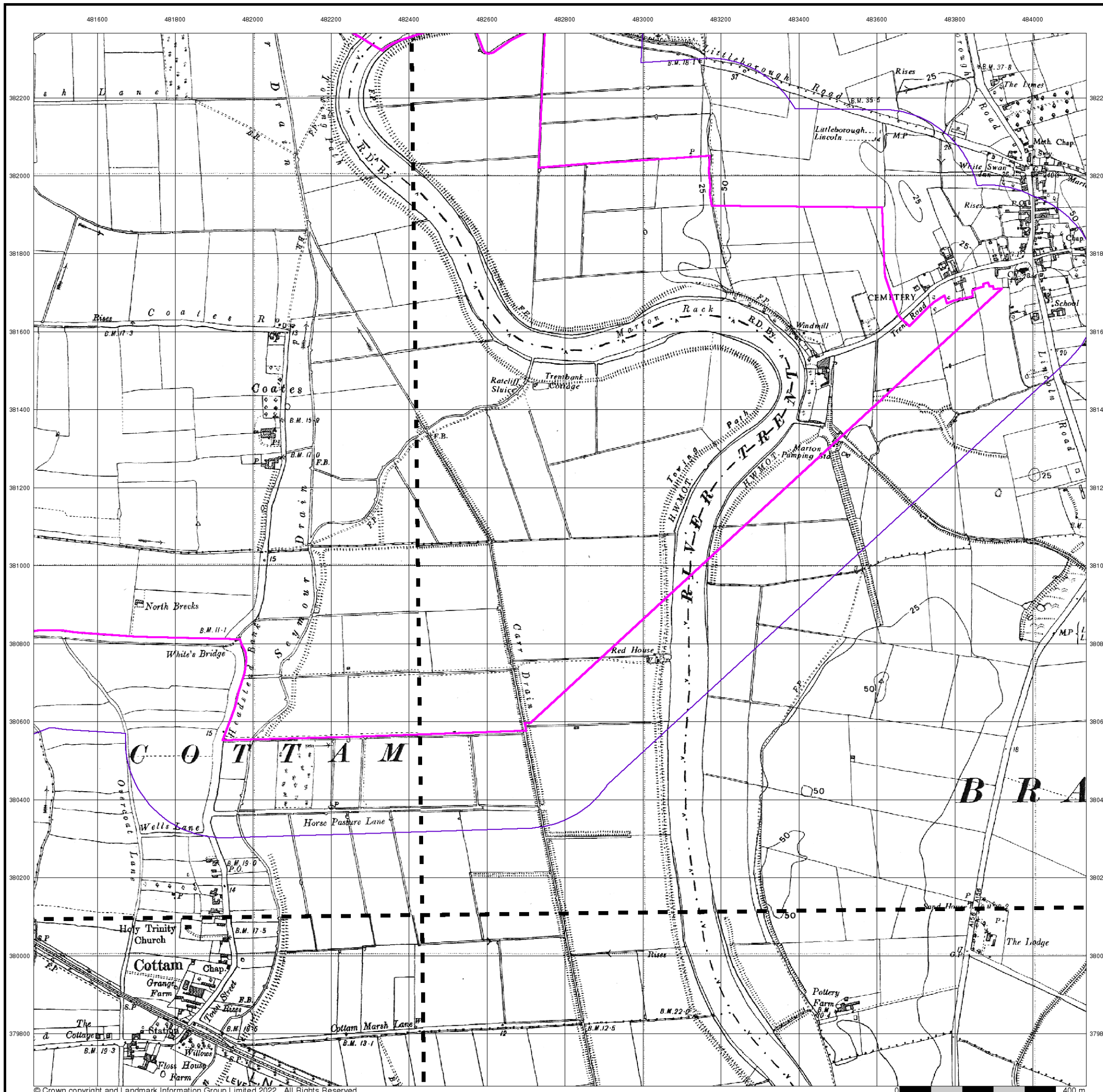

Ordnance Survey Plan

Published 1956

Source map scale - 1:10,000

The historical maps shown were reproduced from maps predominantly held at the scale adopted for England, Wales and Scotland in the 1840's. In 1854 the 1:2,500 scale was adopted for mapping urban areas; these maps were used to update the 1:10,560 maps. The published date given therefore is often some years later than the surveyed date. Before 1938, all OS maps were based on the Cassini Projection, with independent surveys of a single county or group of counties, giving rise to significant inaccuracies in outlying areas. In the late 1940's, a Provisional Edition was produced, which updated the 1:10,560 mapping from a number of sources. The maps appear unfinished - with all military camps and other strategic sites removed. These maps were initially overprinted with the National Grid. In 1970, the first 1:10,000 maps were produced using the Transverse Mercator Projection. The revision process continued until recently, with new editions appearing every 10 years or so for urban areas.

Map Name(s) and Date(s)

SK88SW	1956
1:10,560	
SK87NW	1956
1:10,560	

Historical Map - Slice B

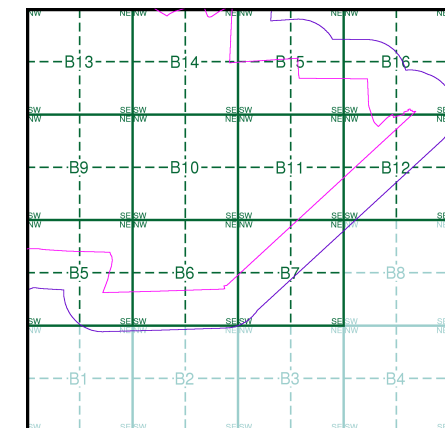

Order Details

Order Number: 298001706_1_1
 Customer Ref: 21-2098.04
 National Grid Reference: 482570, 381420
 Slice: B
 Site Area (Ha): 1355.61
 Search Buffer (m): 250

Site Details

West Barton 2

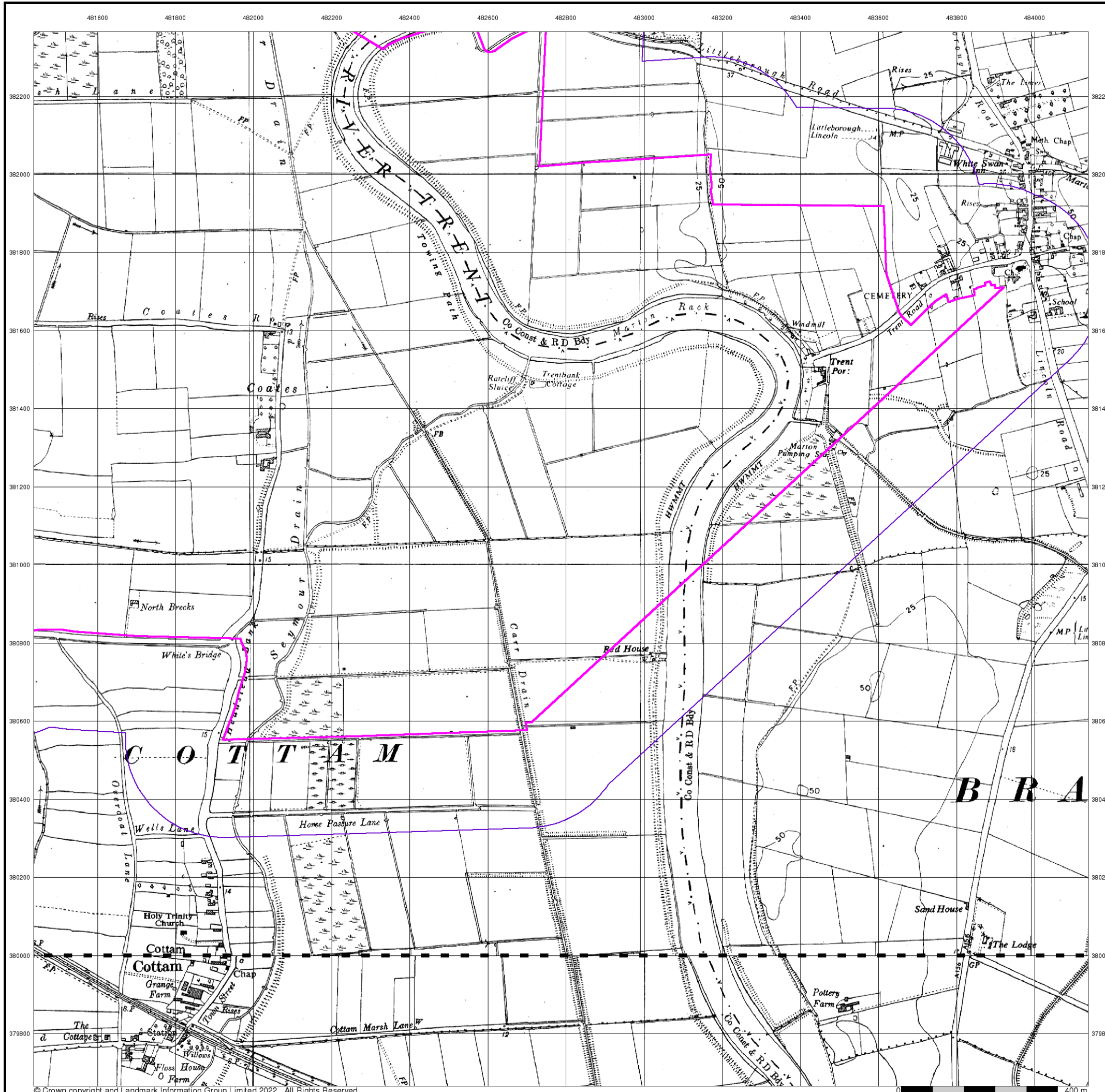

Ordnance Survey Plan

Published 1974

Source map scale - 1:10,000

The historical maps shown were reproduced from maps predominantly held at the scale adopted for England, Wales and Scotland in the 1840's. In 1854 the 1:2,500 scale was adopted for mapping urban areas; these maps were used to update the 1:10,560 maps. The published date given therefore is often some years later than the surveyed date. Before 1938, all OS maps were based on the Cassini Projection, with independent surveys of a single county or group of counties, giving rise to significant inaccuracies in outlying areas. In the late 1940's, a Provisional Edition was produced, which updated the 1:10,560 mapping from a number of sources. The maps appear unfinished - with all military camps and other strategic sites removed. These maps were initially overprinted with the National Grid. In 1970, the first 1:10,000 maps were produced using the Transverse Mercator Projection. The revision process continued until recently, with new editions appearing every 10 years or so for urban areas.

Map Name(s) and Date(s)

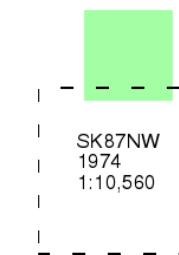

Historical Map - Slice B

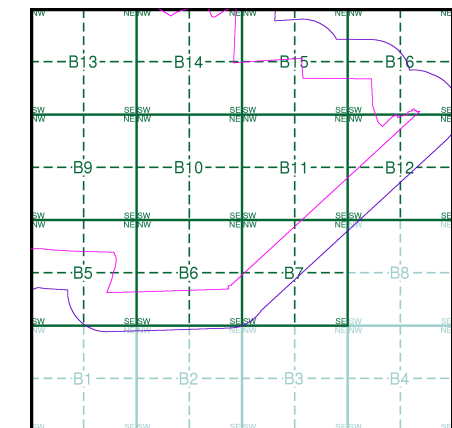

Order Details

Order Number: 298001706_1_1
 Customer Ref: 21-2098.04
 National Grid Reference: 482570, 381420
 Slice: B
 Site Area (Ha): 1355.61
 Search Buffer (m): 250

Site Details

West Barton 2

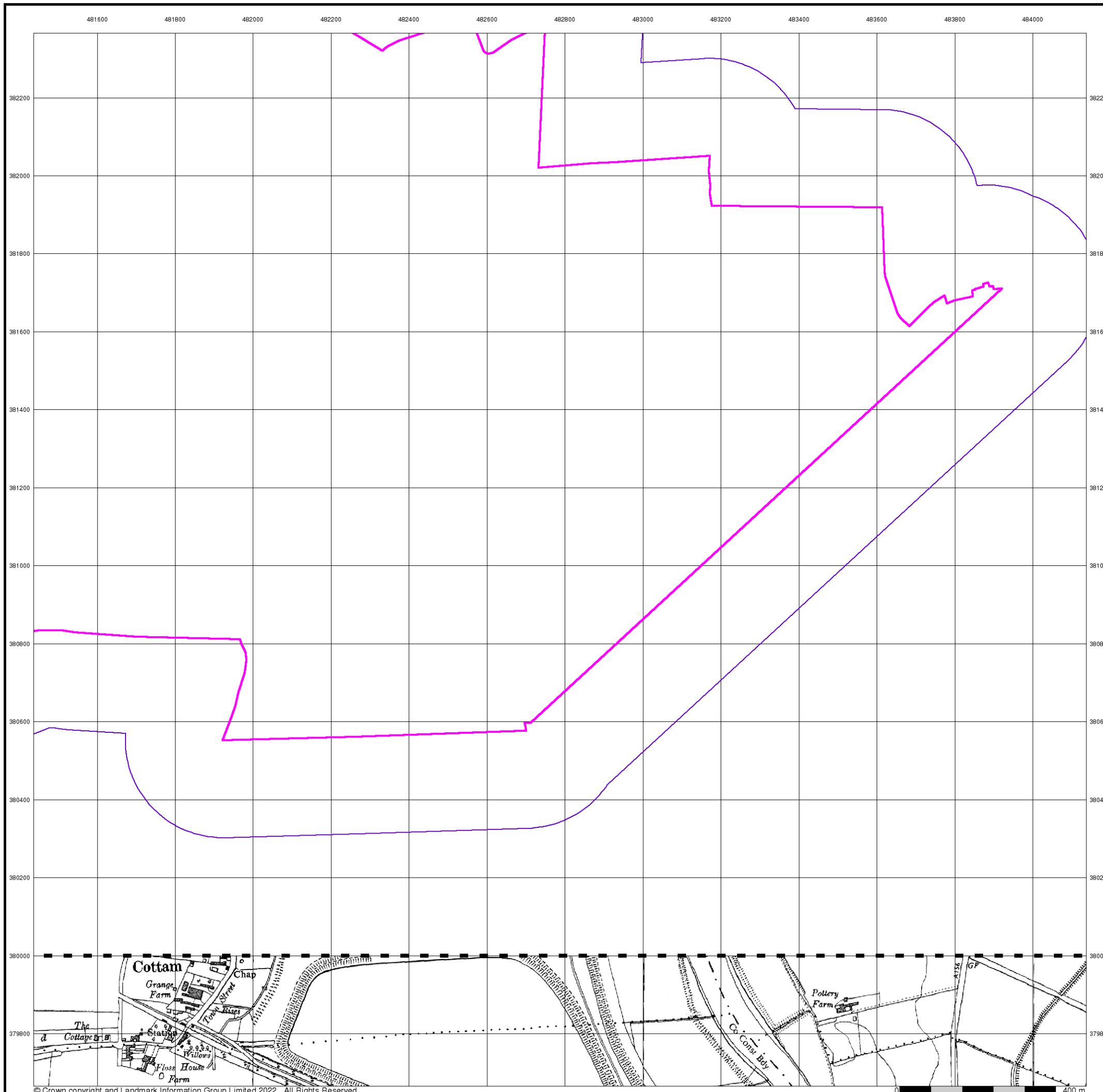

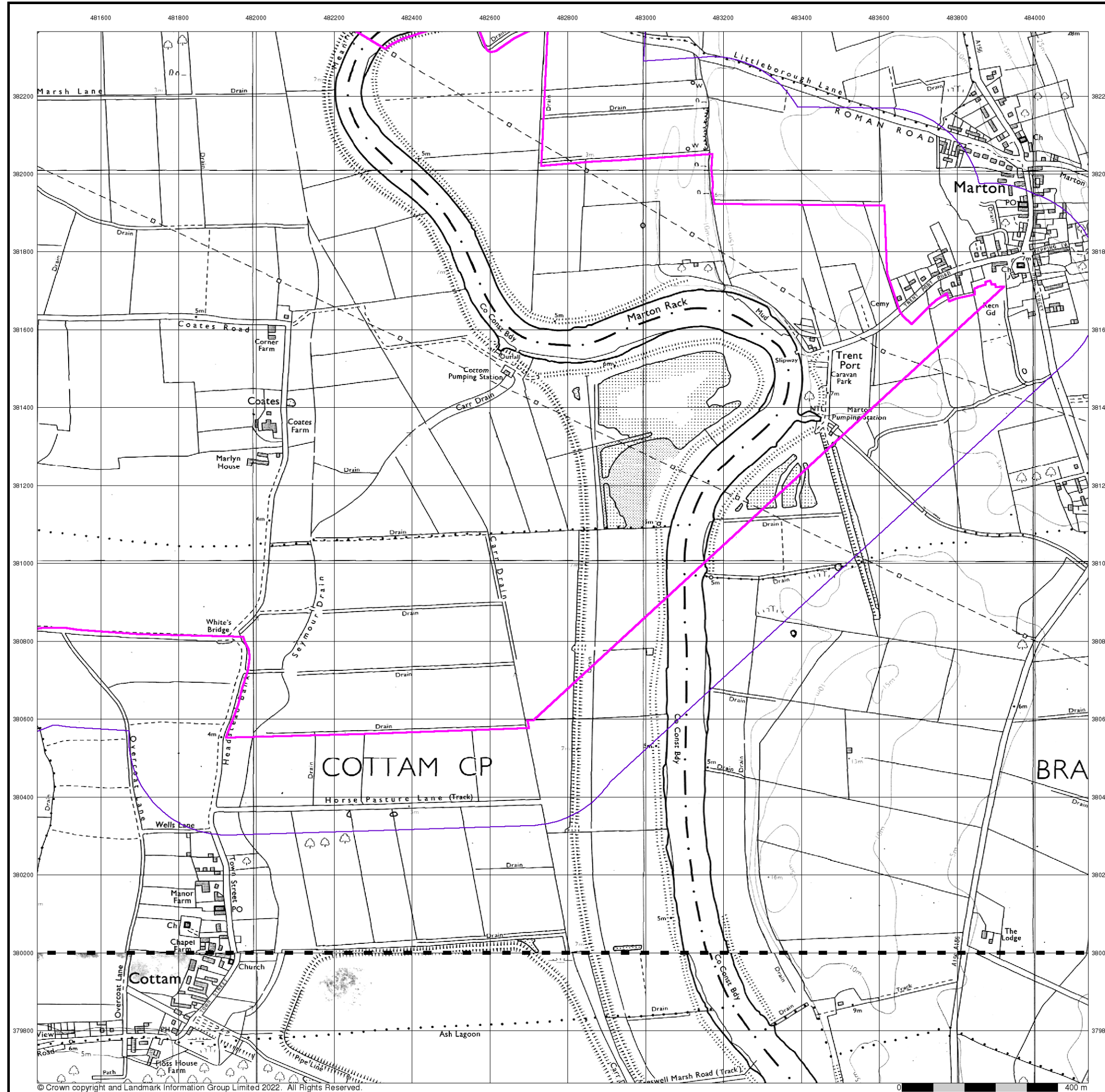

Ordnance Survey Plan

Published 1980

Source map scale - 1:10,000

The historical maps shown were reproduced from maps predominantly held at the scale adopted for England, Wales and Scotland in the 1840's. In 1854 the 1:2,500 scale was adopted for mapping urban areas; these maps were used to update the 1:10,560 maps. The published date given therefore is often some years later than the surveyed date. Before 1938, all OS maps were based on the Cassini Projection, with independent surveys of a single county or group of counties, giving rise to significant inaccuracies in outlying areas. In the late 1940's, a Provisional Edition was produced, which updated the 1:10,560 mapping from a number of sources. The maps appear unfinished - with all military camps and other strategic sites removed. These maps were initially overprinted with the National Grid. In 1970, the first 1:10,000 maps were produced using the Transverse Mercator Projection. The revision process continued until recently, with new editions appearing every 10 years or so for urban areas.

Map Name(s) and Date(s)

SK88SW	1980
1:10,000	
SK87NW	1980
1:10,000	

Historical Map - Slice B

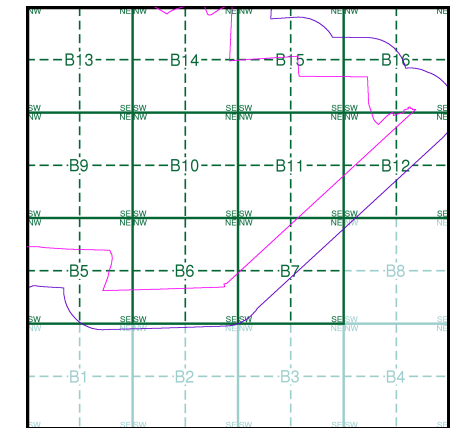

Order Details

Order Number: 298001706_1_1
 Customer Ref: 21-2098.04
 National Grid Reference: 482570, 381420
 Slice: B
 Site Area (Ha): 1355.61
 Search Buffer (m): 250

Site Details

West Barton 2



Tel: 0844 844 9952
 Fax: 0844 844 9951
 Web: [REDACTED]

10k Raster Mapping

Published 2000

Source map scale - 1:10,000

The historical maps shown were produced from the Ordnance Survey's 1:10,000 colour raster mapping. These maps are derived from Landplan which replaced the old 1:10,000 maps originally published in 1970. The data is highly detailed showing buildings, fences and field boundaries as well as all roads, tracks and paths. Road names are also included together with the relevant road number and classification. Boundary information depiction includes county, unitary authority, district, civil parish and constituency.

Map Name(s) and Date(s)

SK88SW	2000
1:10,000	
SK87NW	2000
1:10,000	

Historical Map - Slice B

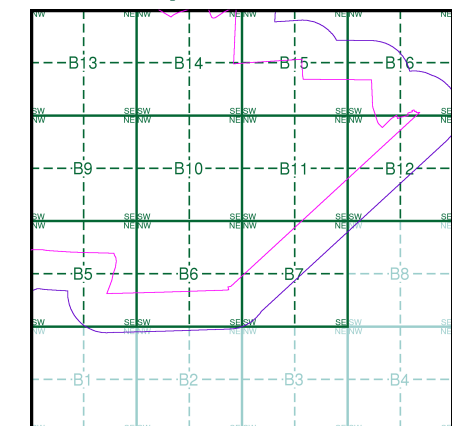

Order Details

Order Number: 298001706_1_1
 Customer Ref: 21-2098.04
 National Grid Reference: 482570, 381420
 Slice: B
 Site Area (Ha): 1355.61
 Search Buffer (m): 250

Site Details

West Barton 2

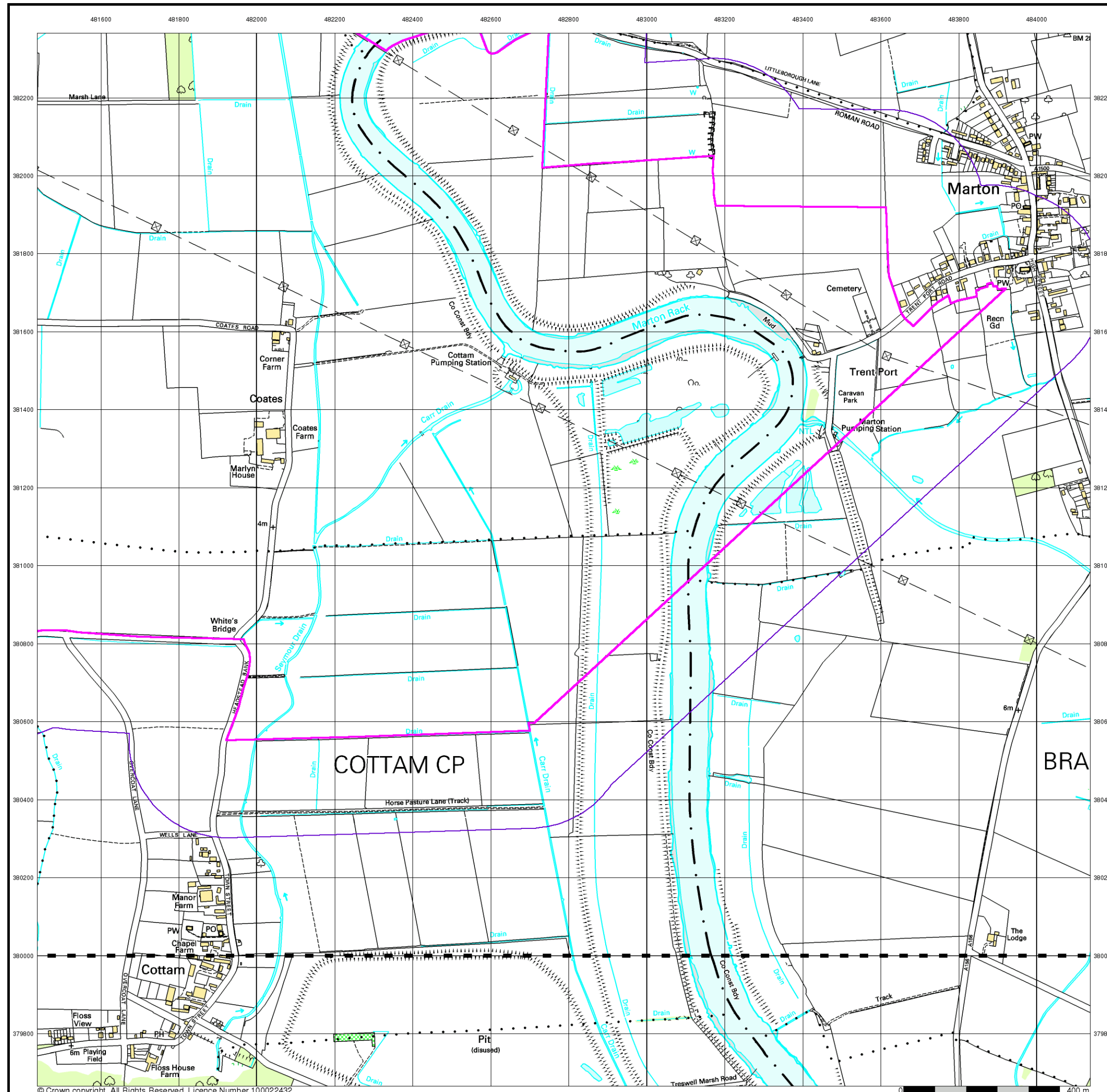

Street View

Published 2022

Source map scale - 1:10,000

Street View is a street-level map for the whole of Great Britain produced by the Ordnance Survey. These maps are provided at a nominal scale of 1:10,000

Map Name(s) and Date(s)



Street View Map - Slice B

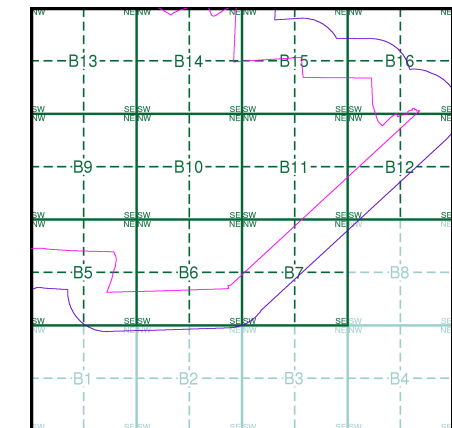

Order Details

Order Number: 298001706_1_1
 Customer Ref: 21-2098.04
 National Grid Reference: 482570, 381420
 Slice: B
 Site Area (Ha): 1355.61
 Search Buffer (m): 250

Site Details

West Barton 2

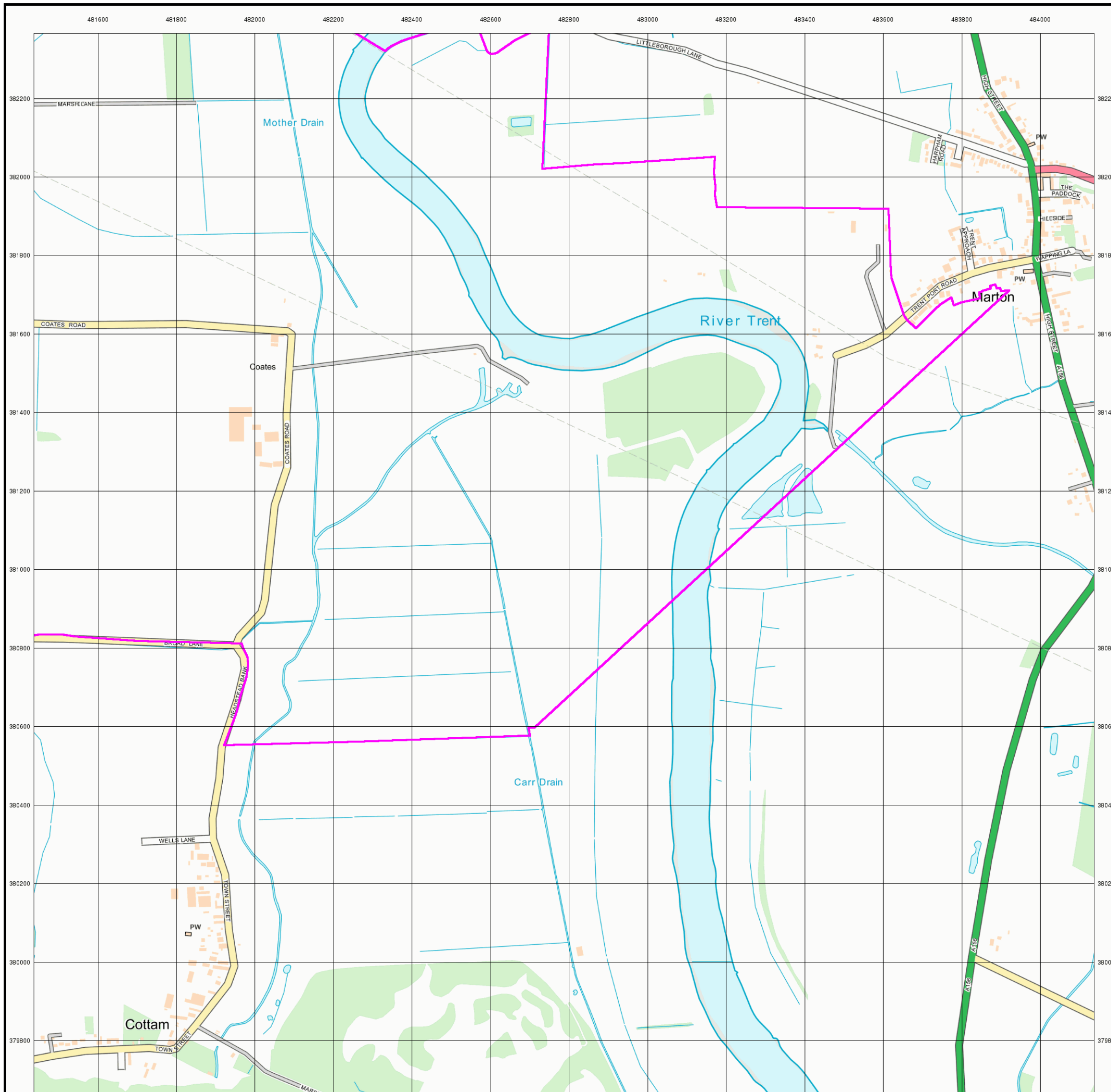

Historical Mapping Legends

Ordnance Survey County Series and Ordnance Survey Plan 1:2,500

Quarry **Gravel Pit** **Sand Pit**

Clay Pit **Shingle** **Refuse Heap**

Sloping Masonry **Flat Rock**

Marsh **Reeds** **Osiers**

Rough Pasture **Furze** **Wood**

Mixed Wood **Brushwood** **Orchard**

Fir **Ford** **Stepping Stones**

Ferry **Waterfall** **Lock**

Trig. Station **Altitude at Trig. Station**

B.M. 325.9 **Bench Mark** **Surface Level**

Arrow denotes flow of water **Antiquities (site of)**

Cutting **Embankment**

Railway crossing Road **Level Crossing** **Road crossing Railway**

Railway crossing River or Canal **Road over single stream** **Road over River or Canal**

County Boundary (Geographical)

County & Civil Parish Boundary

Administrative County & Civil Parish Boundary

County Borough Boundary (England)

Co. Boro. Bdy.

County Burgh Boundary (Scotland)

Boundary Post or Stone **Police Call Box**

B.R. Bridle Road **P Pump**

E.P. Electricity Pylon **S.P. Signal Post**

F.B. Foot Bridge **Sl. Sluice**

F.P. Foot Path **Sp. Spring**

G.P. Guide Post or Board **T.C.B. Telephone Call Box**

M.S. Mile Stone **Tr. Trough**

M.P. M.R. Mooring Post or Ring **W Well**

Ordnance Survey Plan, Additional SIMs and Supply of Unpublished Survey Information 1:2,500 and 1:1,250

Inactive Quarry, Chalk Pit or Clay Pit **Active Quarry, Chalk Pit or Clay Pit**

Rock **Boulders**

Cliff **Slopes** **Top**

Roofed Building **Glazed Roof Building**

Sloping Masonry **Archway**

Non-Coniferous Tree (surveyed) **Coniferous Tree (surveyed)**

Non-Coniferous Trees (not surveyed) **Coniferous Trees (not surveyed)**

Orchard Tree **Scrub** **Bracken**

Coppice, Osier **Reeds** **Marsh, Saltings**

Rough Grassland **Heath** **Culvert**

Direction of water flow **Bench Mark** **Antiquity (site of)**

Cave Entrance **Triangulation Station** **Electricity Pylon**

Electricity Transmission Line

County Boundary (Geographical)

County & Civil Parish Boundary

Civil Parish Boundary

Admin. County or County Bor. Boundary

London Borough Boundary

Symbol marking point where boundary mereing changes

BH Beer House **P Pillar, Pole or Post**

BP, BS Boundary Post or Stone **PO Post Office**

Cn, C Capstan, Crane **PC Public Convenience**

Chy Chimney **PH Public House**

D Fn Drinking Fountain **Pp Pump**

EI P Electricity Pillar or Post **SB, S Br Signal Box or Bridge**

FAP Fire Alarm Pillar **SP, SL Signal Post or Light**

FB Foot Bridge **Spr Spring**

GP Guide Post **Tk Tank or Track**

H Hydrant or Hydraulic **TCB Telephone Call Box**

LC Level Crossing **TCP Telephone Call Post**

MH Manhole **Tr Trough**

MP Mile Post or Mooring Post **Wr Pt, Wr T Water Point, Water Tap**

MS Mile Stone **W Well**

NTL Normal Tidal Limit **Wd Pp Wind Pump**

Large-Scale National Grid Data 1:2,500 and 1:1,250

Cliff **Slopes** **Top**

Rock **Rock (scattered)**

Boulders **Boulders (scattered)**

Positioned Boulder **Scree**

Non-Coniferous Tree (surveyed) **Coniferous Tree (surveyed)**

Non-Coniferous Trees (not surveyed) **Coniferous Trees (not surveyed)**

Orchard Tree **Scrub** **Bracken**

Coppice, Osier **Reeds** **Marsh, Saltings**

Rough Grassland **Heath** **Culvert**

Direction of water flow **Triangulation Station** **Antiquity (site of)**

Electricity Transmission Line **Electricity Pylon**

Bench Mark **Buildings with Building Seed**

Roofed Building **Glazed Roof Building**

Civil parish/community boundary

District boundary

County boundary

Boundary post/stone

Boundary mereing symbol (note: these always appear in opposed pairs or groups of three)

Bks Barracks **P Pillar, Pole or Post**

Bty Battery **PO Post Office**

Cemy Cemetery **PC Public Convenience**

Chy Chimney **Pp Pump**

Cis Cistern **Ppg Sta Pumping Station**

Dismtd Rly Dismantled Railway **PW Place of Worship**

EI Gen Sta Electricity Generating Station **Sewage Ppg Sta Sewage Pumping Station**

EI P Electricity Pole, Pillar **SB, S Br Signal Box or Bridge**

EI Sub Sta Electricity Sub Station **SP, SL Signal Post or Light**

FB Filter Bed **Spr Spring**

Fn / D Fn Fountain / Drinking Ftn. **Tk Tank or Track**

Gas Gov Gas Valve Compound **Tr Trough**

GVC Gas Governor **Wd Pp Wind Pump**

GP Guide Post **Wr Pt, Wr T Water Point, Water Tap**

MH Manhole **Wks Works (building or area)**

MP, MS Mile Post or Mile Stone **W Well**

Historical Mapping & Photography included:

Mapping Type	Scale	Date	Pg
Nottinghamshire	1:2,500	1886	2
Nottinghamshire	1:2,500	1899	3
Nottinghamshire	1:2,500	1920	4
Ordnance Survey Plan	1:2,500	1974 - 1975	5
Large-Scale National Grid Data	1:2,500	1994	6

Historical Map - Segment B5

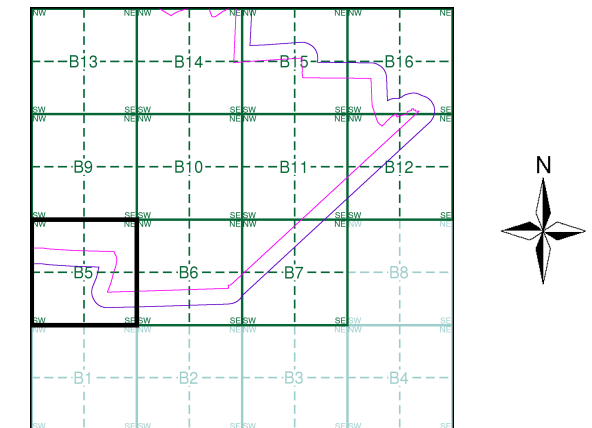

Order Details

Order Number: 298001706_1_1
 Customer Ref: 21-2098.04
 National Grid Reference: 482570, 381420
 Slice: B
 Site Area (Ha): 1355.61
 Search Buffer (m): 100

Site Details

West Barton 2

Nottinghamshire

Published 1886

Source map scale - 1:2,500

The historical maps shown were reproduced from maps predominantly held at the scale adopted for England, Wales and Scotland in the 1840's. In 1854 the 1:2,500 scale was adopted for mapping urban areas and by 1896 it covered the whole of what were considered to be the cultivated parts of Great Britain. The published date given below is often some years later than the surveyed date. Before 1938, all OS maps were based on the Cassini Projection, with independent surveys of a single county or group of counties, giving rise to significant inaccuracies in outlying areas.

Map Name(s) and Date(s)

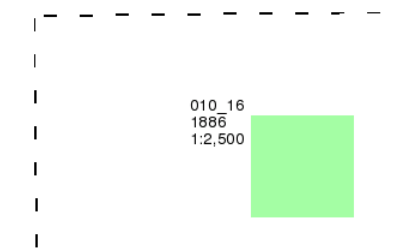

Historical Map - Segment B5

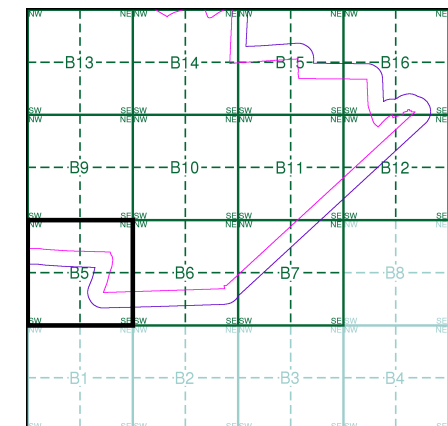

Order Details

Order Number: 298001706_1_1
 Customer Ref: 21-2098.04
 National Grid Reference: 482570, 381420
 Slice: B
 Site Area (Ha): 1355.61
 Search Buffer (m): 100

Site Details

West Barton 2

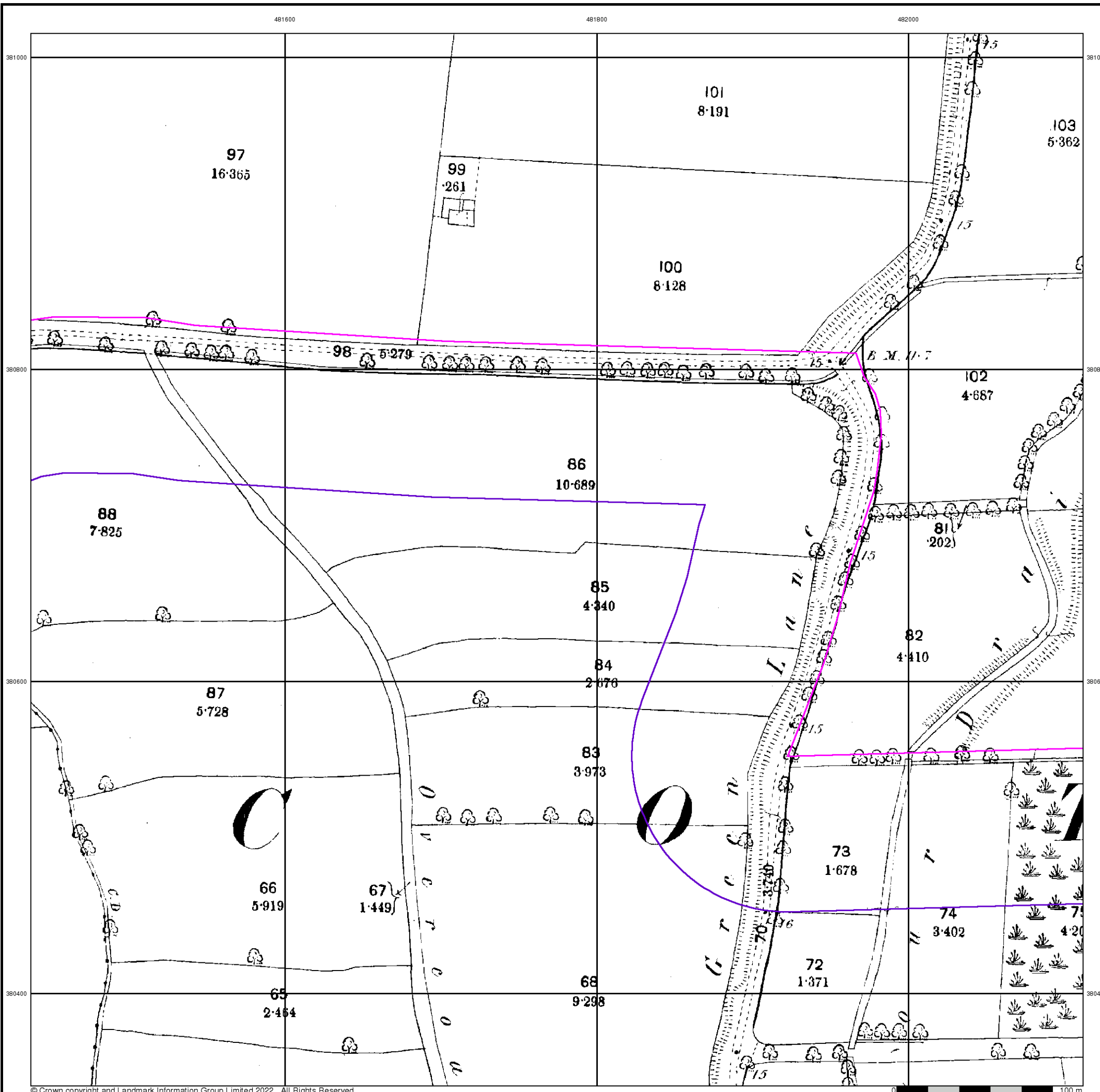

Nottinghamshire

Published 1899

Source map scale - 1:2,500

The historical maps shown were reproduced from maps predominantly held at the scale adopted for England, Wales and Scotland in the 1840's. In 1854 the 1:2,500 scale was adopted for mapping urban areas and by 1896 it covered the whole of what were considered to be the cultivated parts of Great Britain. The published date given below is often some years later than the surveyed date. Before 1938, all OS maps were based on the Cassini Projection, with independent surveys of a single county or group of counties, giving rise to significant inaccuracies in outlying areas.

Map Name(s) and Date(s)

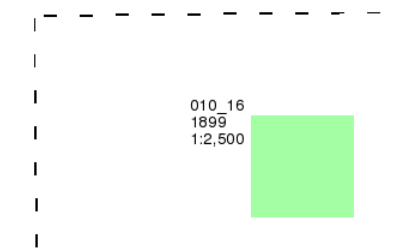

Historical Map - Segment B5

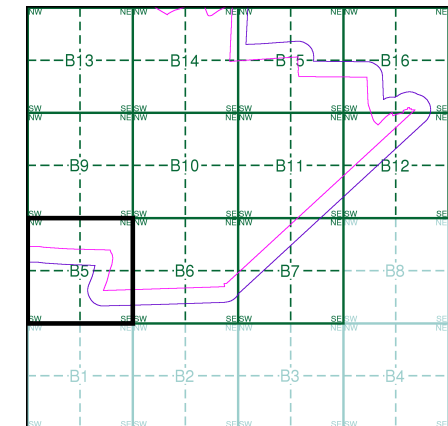

Order Details

Order Number: 298001706_1_1
 Customer Ref: 21-2098.04
 National Grid Reference: 482570, 381420
 Slice: B
 Site Area (Ha): 1355.61
 Search Buffer (m): 100

Site Details

West Barton 2

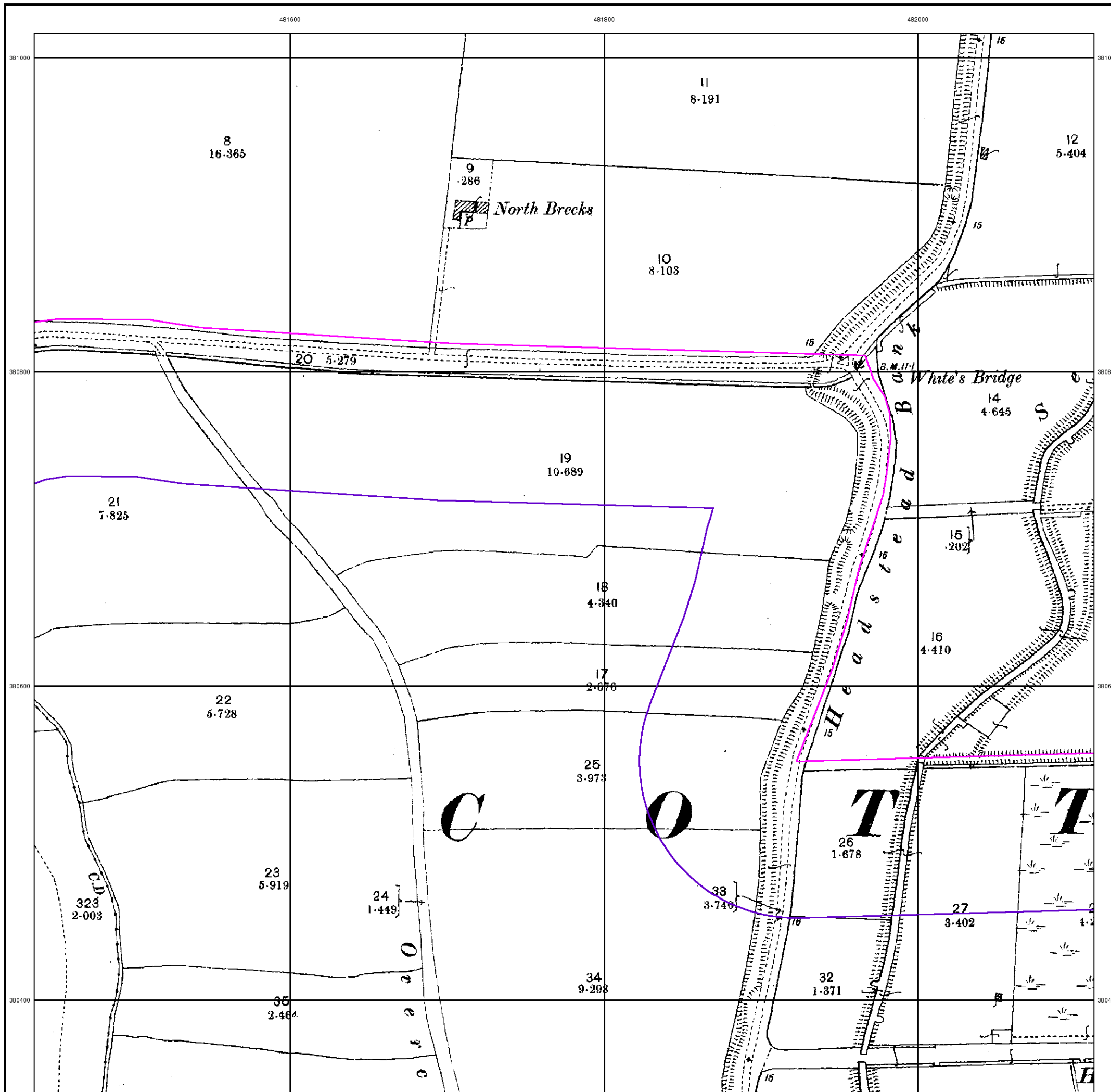

Nottinghamshire

Published 1920

Source map scale - 1:2,500

The historical maps shown were reproduced from maps predominantly held at the scale adopted for England, Wales and Scotland in the 1840's. In 1854 the 1:2,500 scale was adopted for mapping urban areas and by 1896 it covered the whole of what were considered to be the cultivated parts of Great Britain. The published date given below is often some years later than the surveyed date. Before 1938, all OS maps were based on the Cassini Projection, with independent surveys of a single county or group of counties, giving rise to significant inaccuracies in outlying areas.

Map Name(s) and Date(s)

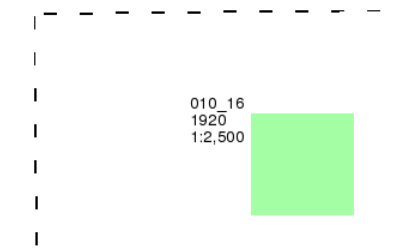

Historical Map - Segment B5

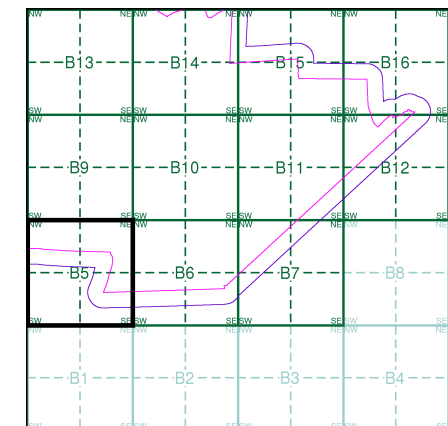

Order Details

Order Number: 298001706_1_1
 Customer Ref: 21-2098.04
 National Grid Reference: 482570, 381420
 Slice: B
 Site Area (Ha): 1355.61
 Search Buffer (m): 100

Site Details

West Barton 2

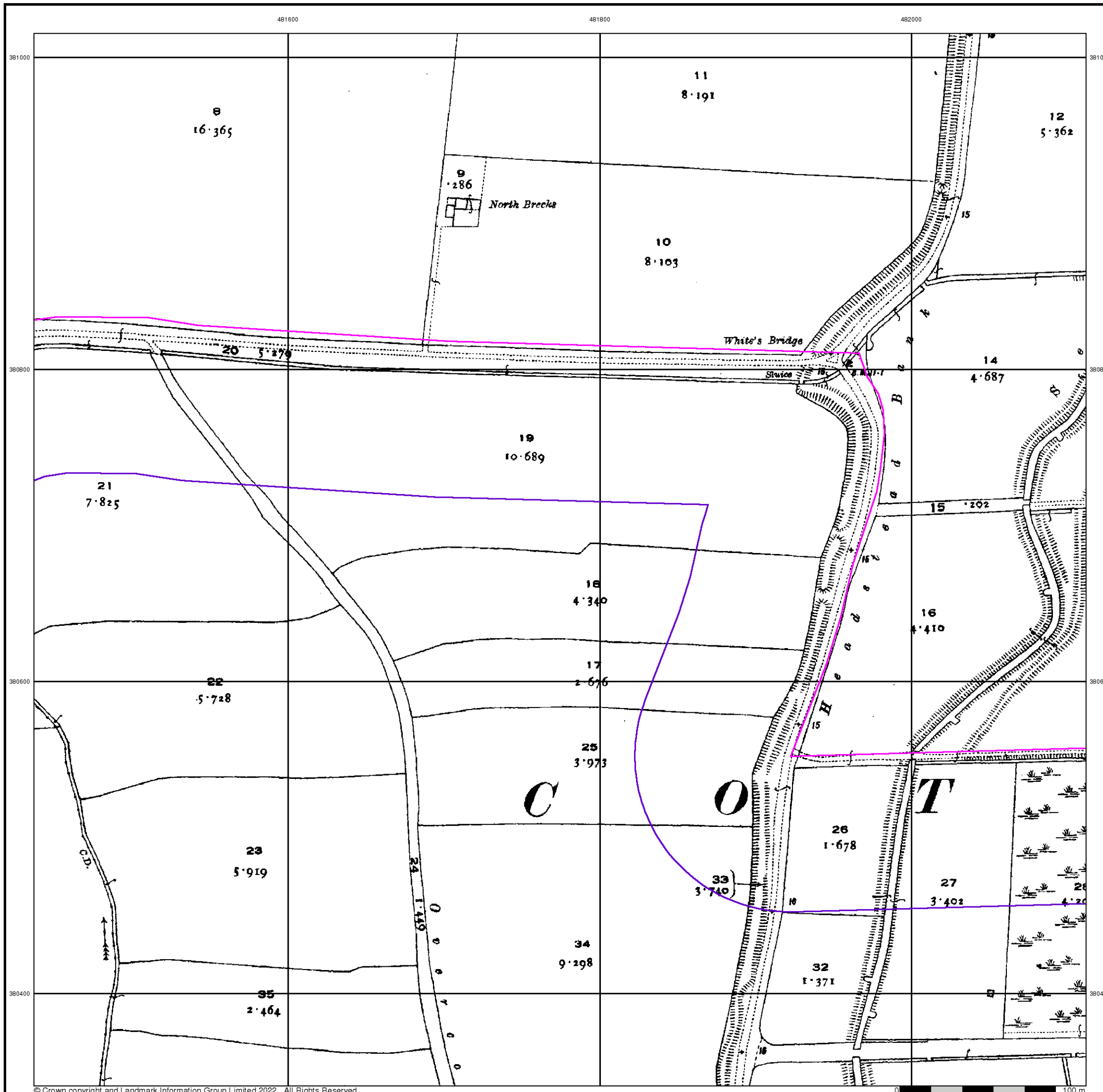

Ordnance Survey Plan
Published 1974 - 1975
Source map scale - 1:2,500

The historical maps shown were reproduced from maps predominantly held at the scale adopted for England, Wales and Scotland in the 1840's. In 1854 the 1:2,500 scale was adopted for mapping urban areas and by 1896 it covered the whole of what were considered to be the cultivated parts of Great Britain. The published date given below is often some years later than the surveyed date. Before 1938, all OS maps were based on the Cassini Projection, with independent surveys of a single county or group of counties, giving rise to significant inaccuracies in outlying areas.

Map Name(s) and Date(s)

SK8181 1974 1:2,500	SK8281 1975 1:2,500
SK8180 1974 1:2,500	SK8280 1974 1:2,500

Historical Map - Segment B5

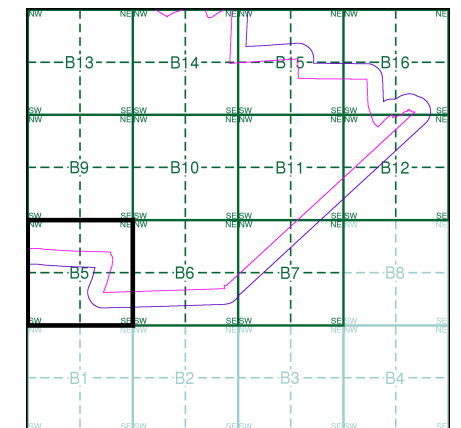

Order Details

Order Number: 298001706_1_1
 Customer Ref: 21-2098.04
 National Grid Reference: 482570, 381420
 Slice: B
 Site Area (Ha): 1355.61
 Search Buffer (m): 100

Site Details

West Barton 2

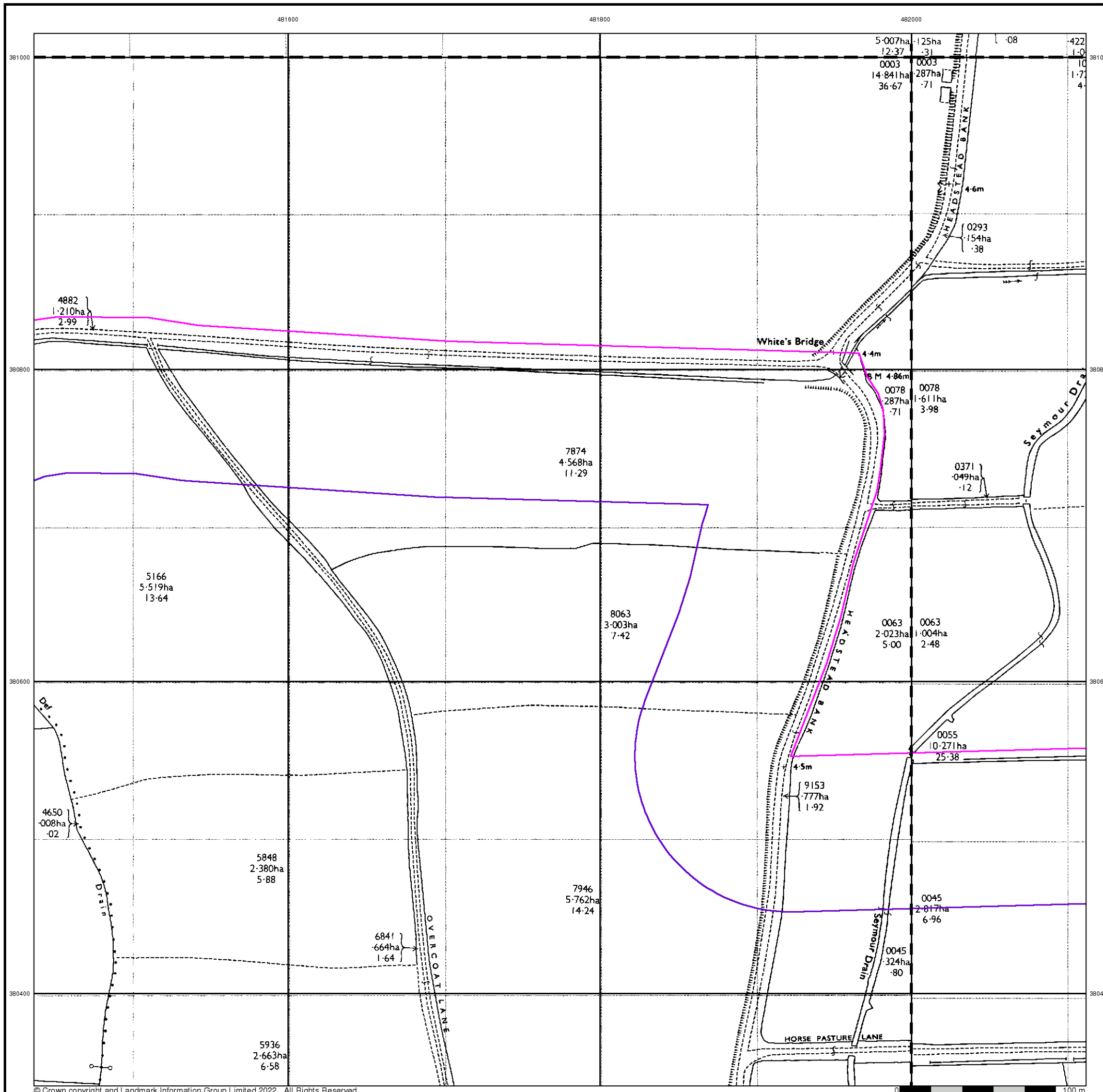

Large-Scale National Grid Data

Published 1994

Source map scale - 1:2,500

'Large Scale National Grid Data' superseded SIM cards (Ordnance Survey's 'Survey of Information on Microfilm') in 1992, and continued to be produced until 1999. These maps were the fore-runners of digital mapping and so provide detailed information on houses and roads, but tend to show less topographic features such as vegetation. These maps were produced at both 1:2,500 and 1:1,250 scales.

Map Name(s) and Date(s)

SK8181 1994 1:2,500	SK8281 1994 1:2,500
SK8180 1994 1:2,500	SK8280 1994 1:2,500

Historical Map - Segment B5

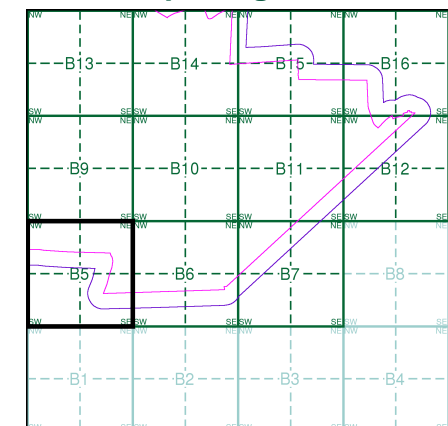

Order Details

Order Number: 298001706_1_1
 Customer Ref: 21-2098.04
 National Grid Reference: 482570, 381420
 Slice: B
 Site Area (Ha): 1355.61
 Search Buffer (m): 100

Site Details

West Barton 2

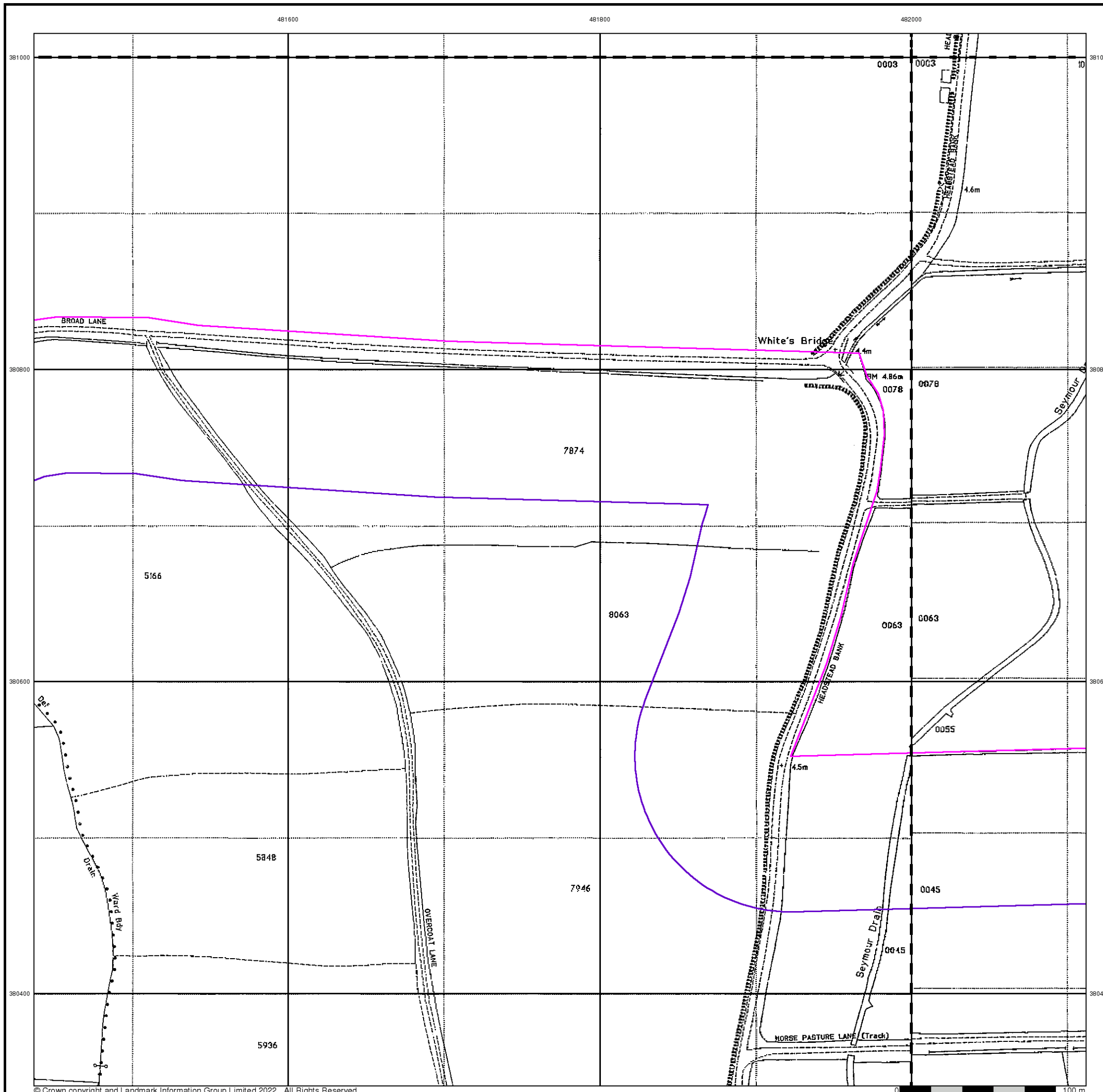

Historical Mapping Legends

Ordnance Survey County Series and Ordnance Survey Plan 1:2,500

Quarry **Gravel Pit** **Sand Pit**
Clay Pit **Shingle** **Refuse Heap**
Sloping Masonry **Flat Rock**
Marsh **Reeds** **Osiers**
Rough Pasture **Furze** **Wood**
Mixed Wood **Brushwood** **Orchard**
Fir **Ford** **Stepping Stones**
Ferry **Waterfall** **Lock**
Trig. Station **Altitude at Trig. Station**
B.M. 325.9 **Bench Mark** **Surface Level**
Arrow denotes flow of water **Antiquities (site of)**
Cutting **Embankment**
Railway crossing Road **Level Crossing** **Road crossing Railway**
Railway crossing River or Canal **Road over single stream** **Road over River or Canal**
County Boundary (Geographical)
County & Civil Parish Boundary
Administrative County & Civil Parish Boundary
County Borough Boundary (England)
County Burgh Boundary (Scotland)
Boundary Post or Stone **Police Call Box**
B.R. Bridle Road **Pump**
E.P. Electricity Pylon **S.P. Signal Post**
F.B. Foot Bridge **Sl. Sluice**
F.P. Foot Path **Sp. Spring**
G.P. Guide Post or Board **T.C.B. Telephone Call Box**
M.S. Mile Stone **Tr. Trough**
M.P. M.R. Mooring Post or Ring **W. Well**

Ordnance Survey Plan, Additional SIMs and Supply of Unpublished Survey Information 1:2,500 and 1:1,250

Inactive Quarry, Chalk Pit or Clay Pit **Active Quarry, Chalk Pit or Clay Pit**
Rock **Boulders**
Cliff **Slopes** **Top**
Roofed Building **Glazed Roof Building**
Sloping Masonry **Archway**
Non-Coniferous Tree (surveyed) **Coniferous Tree (surveyed)**
Non-Coniferous Trees (not surveyed) **Coniferous Trees (not surveyed)**
Orchard Tree **Scrub** **Bracken**
Coppice, Osier **Reeds** **Marsh, Saltings**
Rough Grassland **Heath** **Culvert**
Direction of water flow **Bench Mark** **Antiquity (site of)**
Cave Entrance **Triangulation Station** **Electricity Pylon**
Electricity Transmission Line
County Boundary (Geographical)
County & Civil Parish Boundary
Civil Parish Boundary
Admin. County or County Bor. Boundary
London Borough Boundary
Symbol marking point where boundary mereing changes
BH Beer House **P Pillar, Pole or Post**
BP, BS Boundary Post or Stone **PO Post Office**
Cn, C Capstan, Crane **PC Public Convenience**
Chy Chimney **PH Public House**
D Fn Drinking Fountain **Pp Pump**
EI P Electricity Pillar or Post **SB, S Br Signal Box or Bridge**
FAP Fire Alarm Pillar **SP, SL Signal Post or Light**
FB Foot Bridge **Spr Spring**
GP Guide Post **Tk Tank or Track**
H Hydrant or Hydraulic **TCB Telephone Call Box**
LC Level Crossing **TCP Telephone Call Post**
MH Manhole **Tr Trough**
MP Mile Post or Mooring Post **Wr Pt, Wr T Water Point, Water Tap**
MS Mile Stone **W Well**
NTL Normal Tidal Limit **Wd Pp Wind Pump**

Large-Scale National Grid Data 1:2,500 and 1:1,250

Cliff **Slopes** **Top**
Rock **Rock (scattered)**
Boulders **Boulders (scattered)**
Positioned Boulder **Scree**
Non-Coniferous Tree (surveyed) **Coniferous Tree (surveyed)**
Non-Coniferous Trees (not surveyed) **Coniferous Trees (not surveyed)**
Orchard Tree **Scrub** **Bracken**
Coppice, Osier **Reeds** **Marsh, Saltings**
Rough Grassland **Heath** **Culvert**
Direction of water flow **Triangulation Station** **Antiquity (site of)**
Electricity Transmission Line **Electricity Pylon**
Bench Mark **Buildings with Building Seed**
Roofed Building **Glazed Roof Building**
Civil parish/community boundary
District boundary
County boundary
Boundary post/stone
Boundary mereing symbol (note: these always appear in opposed pairs or groups of three)
Bks Barracks **P Pillar, Pole or Post**
Bty Battery **PO Post Office**
Cemy Cemetery **PC Public Convenience**
Chy Chimney **Pp Pump**
Cis Cistern **Ppg Sta Pumping Station**
Dismtd Rly Dismantled Railway **PW Place of Worship**
EI Gen Sta Electricity Generating Station **Sewage Ppg Sta Sewage Pumping Station**
EI P Electricity Pole, Pillar **SB, S Br Signal Box or Bridge**
EI Sub Sta Electricity Sub Station **SP, SL Signal Post or Light**
FB Filter Bed **Spr Spring**
Fn / D Fn Fountain / Drinking Ftn. **Tk Tank or Track**
Gas Gov Gas Valve Compound **Tr Trough**
GVC Gas Governor **Wd Pp Wind Pump**
GP Guide Post **Wr Pt, Wr T Water Point, Water Tap**
MH Manhole **Wks Works (building or area)**
MP, MS Mile Post or Mile Stone **W Well**

Historical Mapping & Photography included:

Mapping Type	Scale	Date	Pg
Lincolnshire	1:2,500	1886	2
Nottinghamshire	1:2,500	1886	3
Nottinghamshire	1:2,500	1899	4
Lincolnshire	1:2,500	1920	5
Nottinghamshire	1:2,500	1920	6
Ordnance Survey Plan	1:2,500	1974 - 1975	7
Large-Scale National Grid Data	1:2,500	1994	8

Historical Map - Segment B6

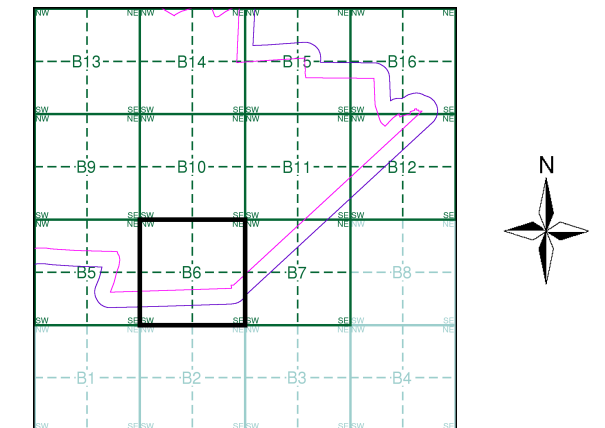

Order Details

Order Number: 298001706_1_1
 Customer Ref: 21-2098.04
 National Grid Reference: 482570, 381420
 Slice: B
 Site Area (Ha): 1355.61
 Search Buffer (m): 100

Site Details

West Barton 2

Lincolnshire

Published 1886

Source map scale - 1:2,500

The historical maps shown were reproduced from maps predominantly held at the scale adopted for England, Wales and Scotland in the 1840's. In 1854 the 1:2,500 scale was adopted for mapping urban areas and by 1896 it covered the whole of what were considered to be the cultivated parts of Great Britain. The published date given below is often some years later than the surveyed date. Before 1938, all OS maps were based on the Cassini Projection, with independent surveys of a single county or group of counties, giving rise to significant inaccuracies in outlying areas.

Map Name(s) and Date(s)

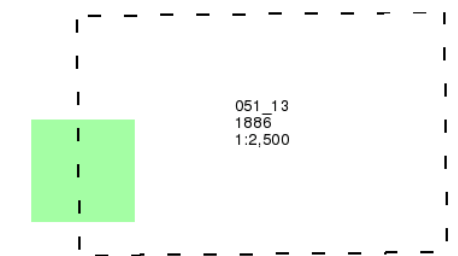

Historical Map - Segment B6

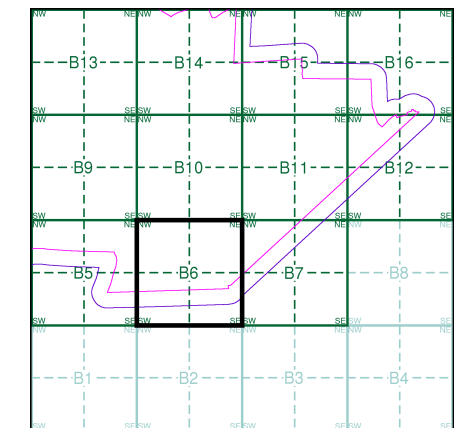

Order Details

Order Number: 298001706_1_1
 Customer Ref: 21-2098.04
 National Grid Reference: 482570, 381420
 Slice: B
 Site Area (Ha): 1355.61
 Search Buffer (m): 100

Site Details

West Barton 2

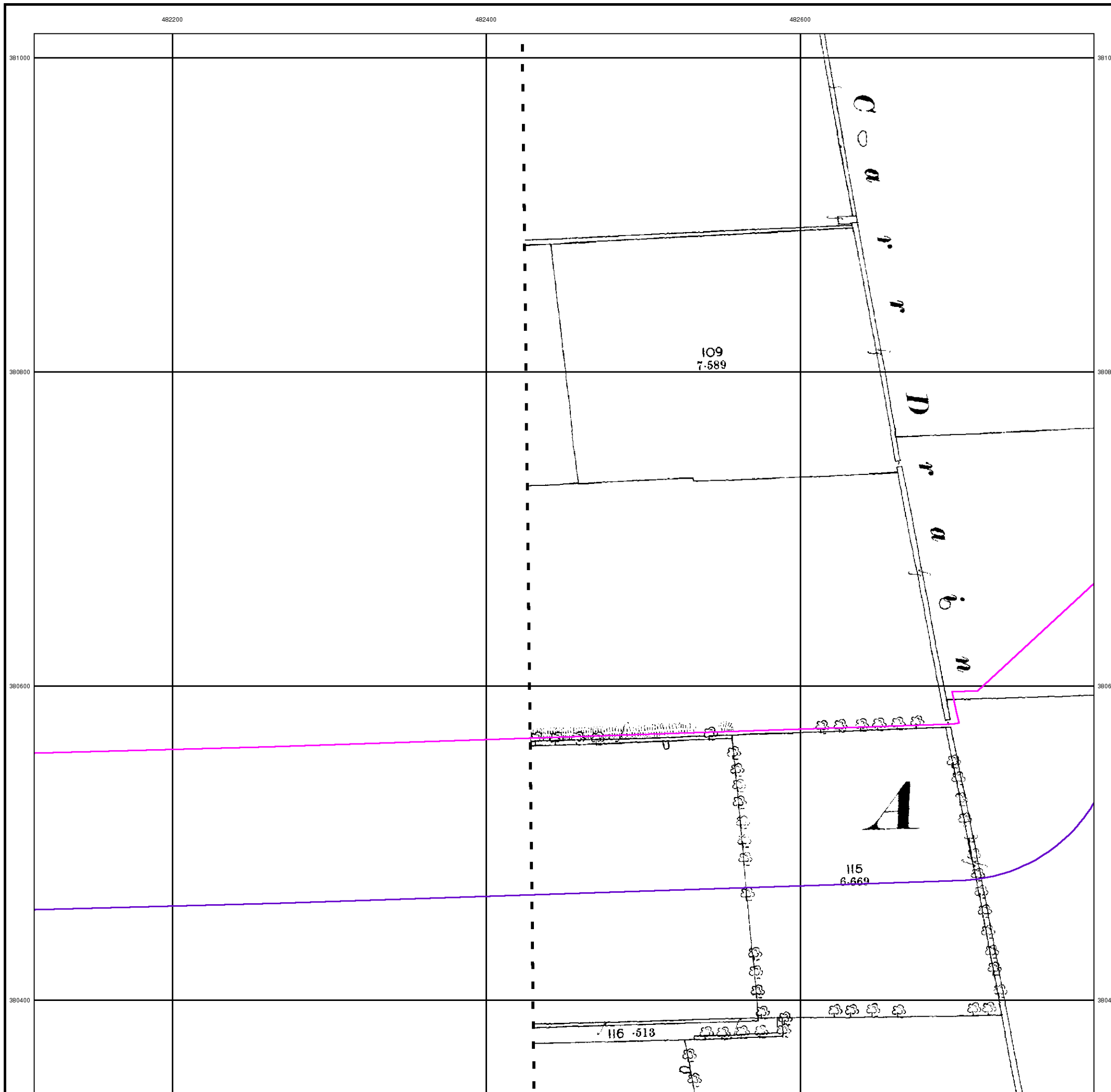

Nottinghamshire

Published 1886

Source map scale - 1:2,500

The historical maps shown were reproduced from maps predominantly held at the scale adopted for England, Wales and Scotland in the 1840's. In 1854 the 1:2,500 scale was adopted for mapping urban areas and by 1896 it covered the whole of what were considered to be the cultivated parts of Great Britain. The published date given below is often some years later than the surveyed date. Before 1938, all OS maps were based on the Cassini Projection, with independent surveys of a single county or group of counties, giving rise to significant inaccuracies in outlying areas.

Map Name(s) and Date(s)

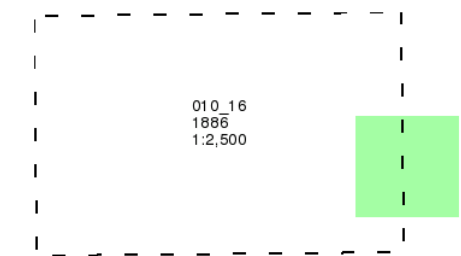

Historical Map - Segment B6

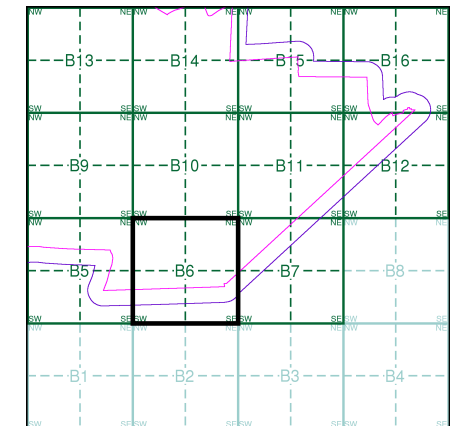

Order Details

Order Number: 298001706_1_1
 Customer Ref: 21-2098.04
 National Grid Reference: 482570, 381420
 Slice: B
 Site Area (Ha): 1355.61
 Search Buffer (m): 100

Site Details

West Barton 2

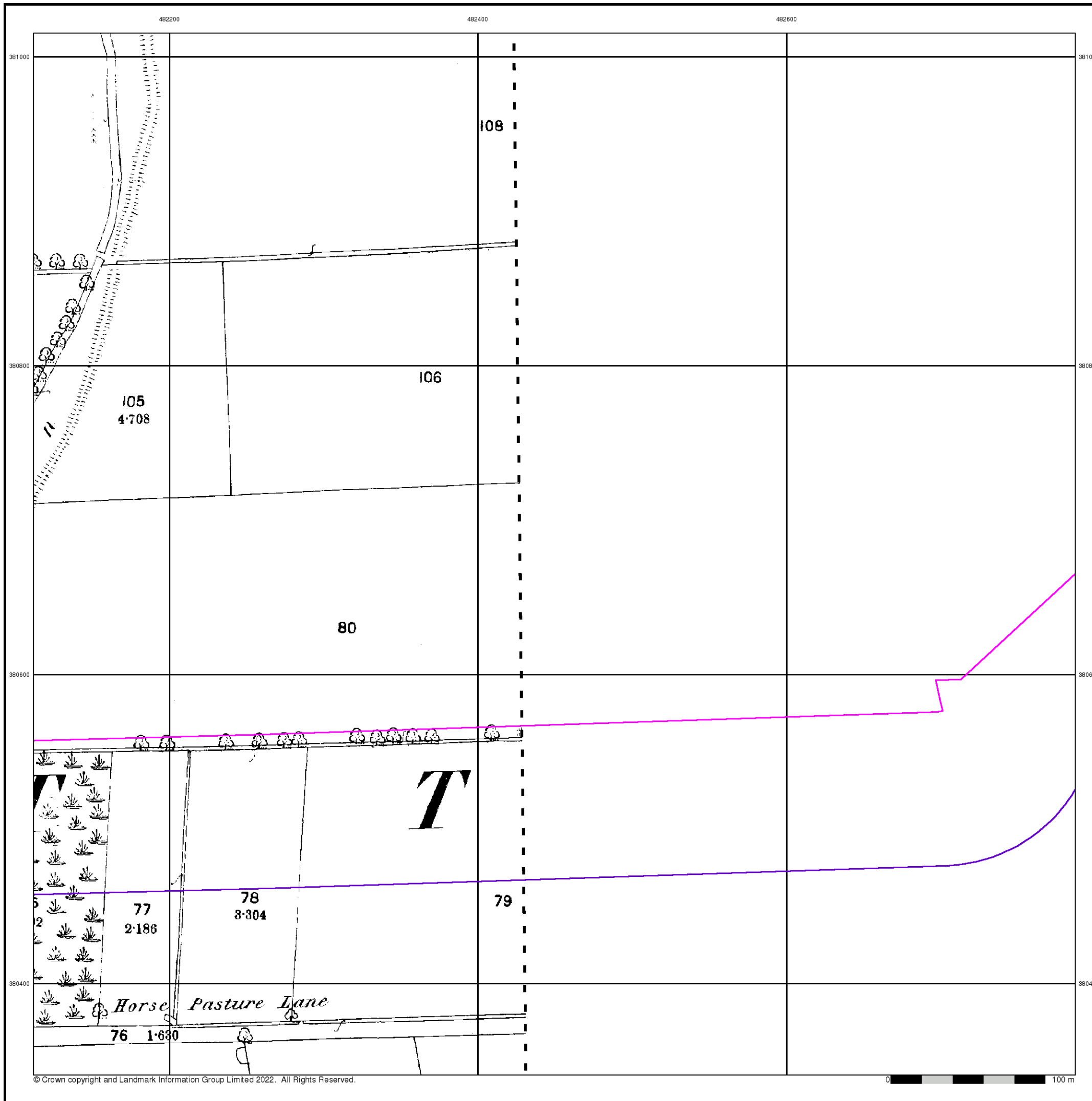

Nottinghamshire

Published 1899

Source map scale - 1:2,500

The historical maps shown were reproduced from maps predominantly held at the scale adopted for England, Wales and Scotland in the 1840's. In 1854 the 1:2,500 scale was adopted for mapping urban areas and by 1896 it covered the whole of what were considered to be the cultivated parts of Great Britain. The published date given below is often some years later than the surveyed date. Before 1938, all OS maps were based on the Cassini Projection, with independent surveys of a single county or group of counties, giving rise to significant inaccuracies in outlying areas.

Map Name(s) and Date(s)

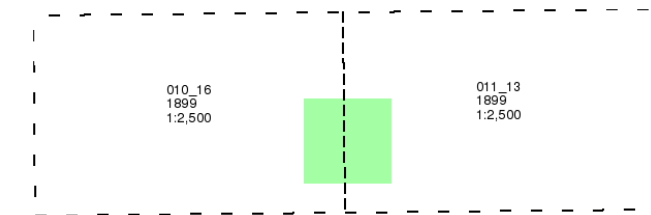

Historical Map - Segment B6

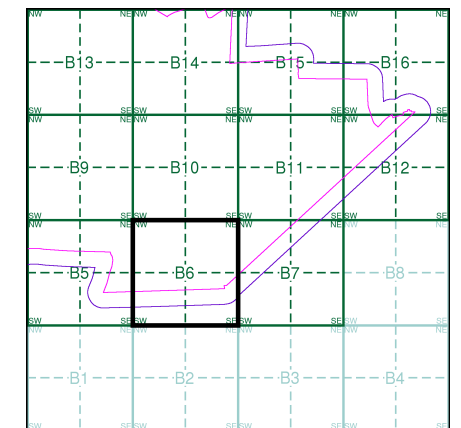

Order Details

Order Number: 298001706_1_1
 Customer Ref: 21-2098.04
 National Grid Reference: 482570, 381420
 Slice: B
 Site Area (Ha): 1355.61
 Search Buffer (m): 100

Site Details

West Barton 2

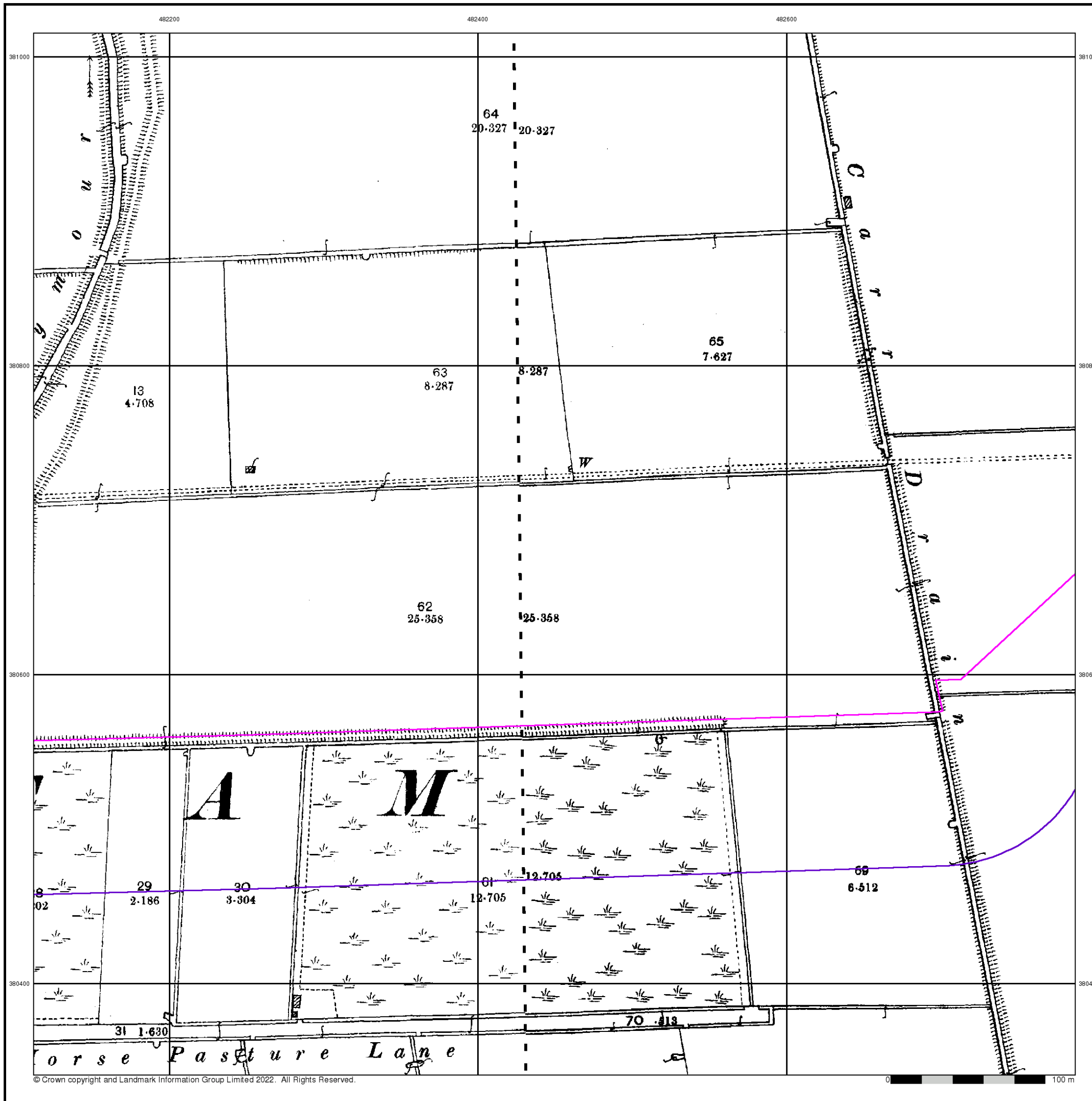

Lincolnshire

Published 1920

Source map scale - 1:2,500

The historical maps shown were reproduced from maps predominantly held at the scale adopted for England, Wales and Scotland in the 1840's. In 1854 the 1:2,500 scale was adopted for mapping urban areas and by 1896 it covered the whole of what were considered to be the cultivated parts of Great Britain. The published date given below is often some years later than the surveyed date. Before 1938, all OS maps were based on the Cassini Projection, with independent surveys of a single county or group of counties, giving rise to significant inaccuracies in outlying areas.

Map Name(s) and Date(s)

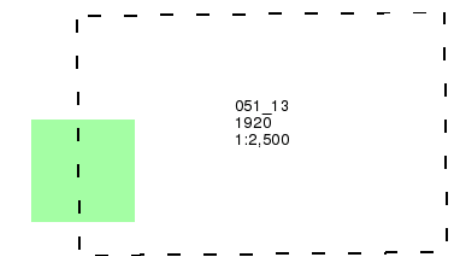

Historical Map - Segment B6

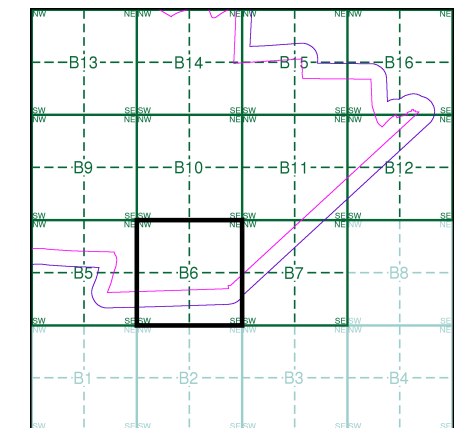

Order Details

Order Number: 298001706_1_1
 Customer Ref: 21-2098.04
 National Grid Reference: 482570, 381420
 Slice: B
 Site Area (Ha): 1355.61
 Search Buffer (m): 100

Site Details

West Barton 2

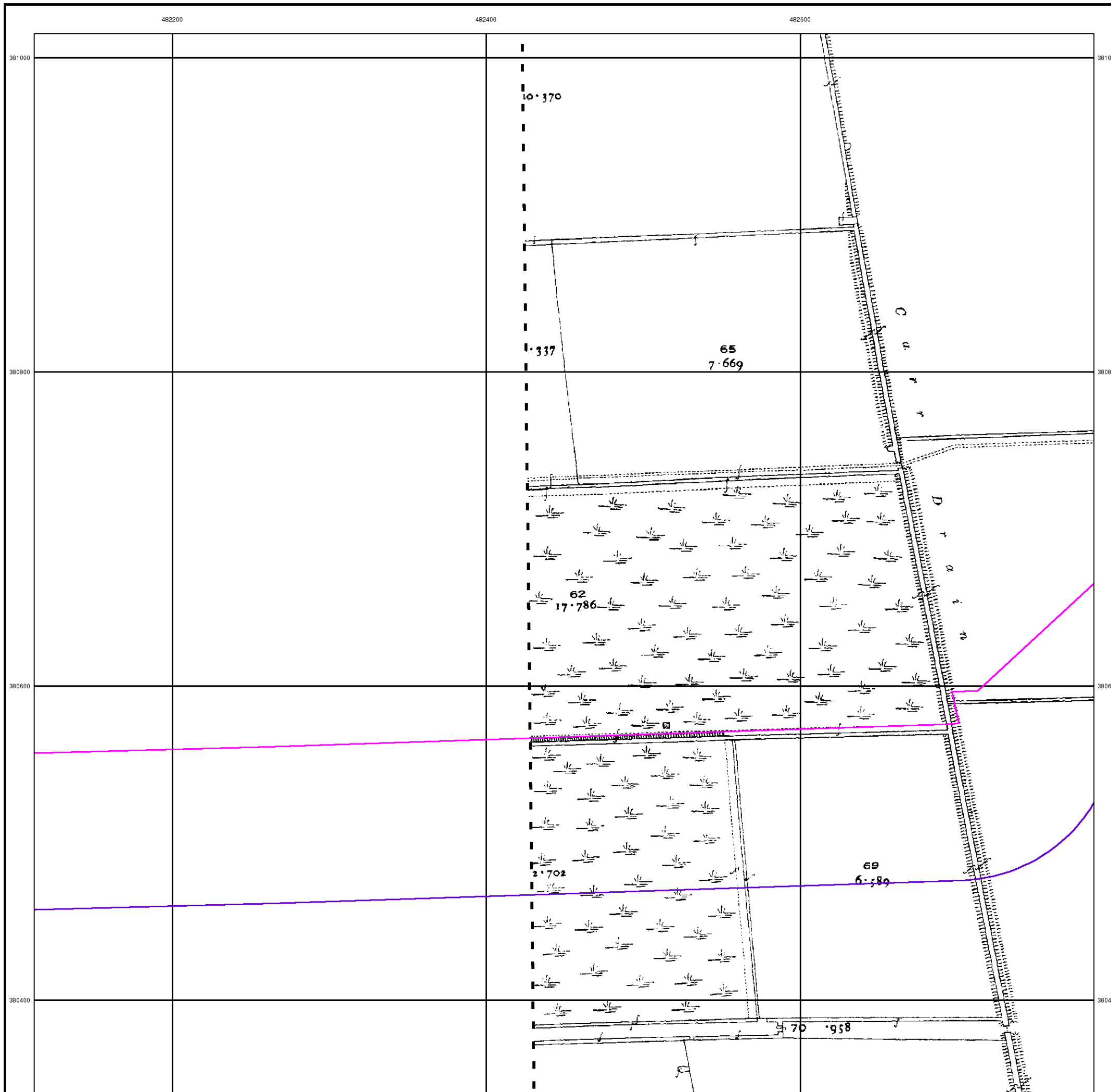

Nottinghamshire

Published 1920

Source map scale - 1:2,500

The historical maps shown were reproduced from maps predominantly held at the scale adopted for England, Wales and Scotland in the 1840's. In 1854 the 1:2,500 scale was adopted for mapping urban areas and by 1896 it covered the whole of what were considered to be the cultivated parts of Great Britain. The published date given below is often some years later than the surveyed date. Before 1938, all OS maps were based on the Cassini Projection, with independent surveys of a single county or group of counties, giving rise to significant inaccuracies in outlying areas.

Map Name(s) and Date(s)

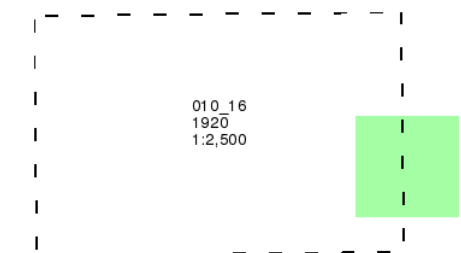

Historical Map - Segment B6

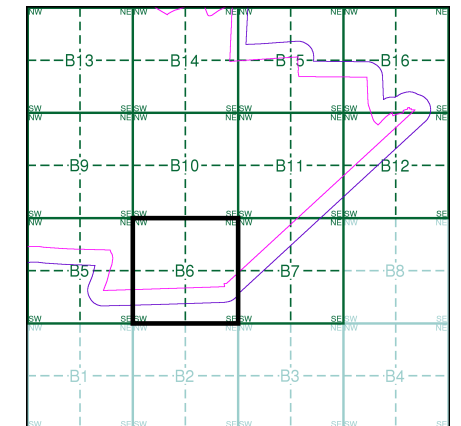

Order Details

Order Number: 298001706_1_1
 Customer Ref: 21-2098.04
 National Grid Reference: 482570, 381420
 Slice: B
 Site Area (Ha): 1355.61
 Search Buffer (m): 100

Site Details

West Barton 2

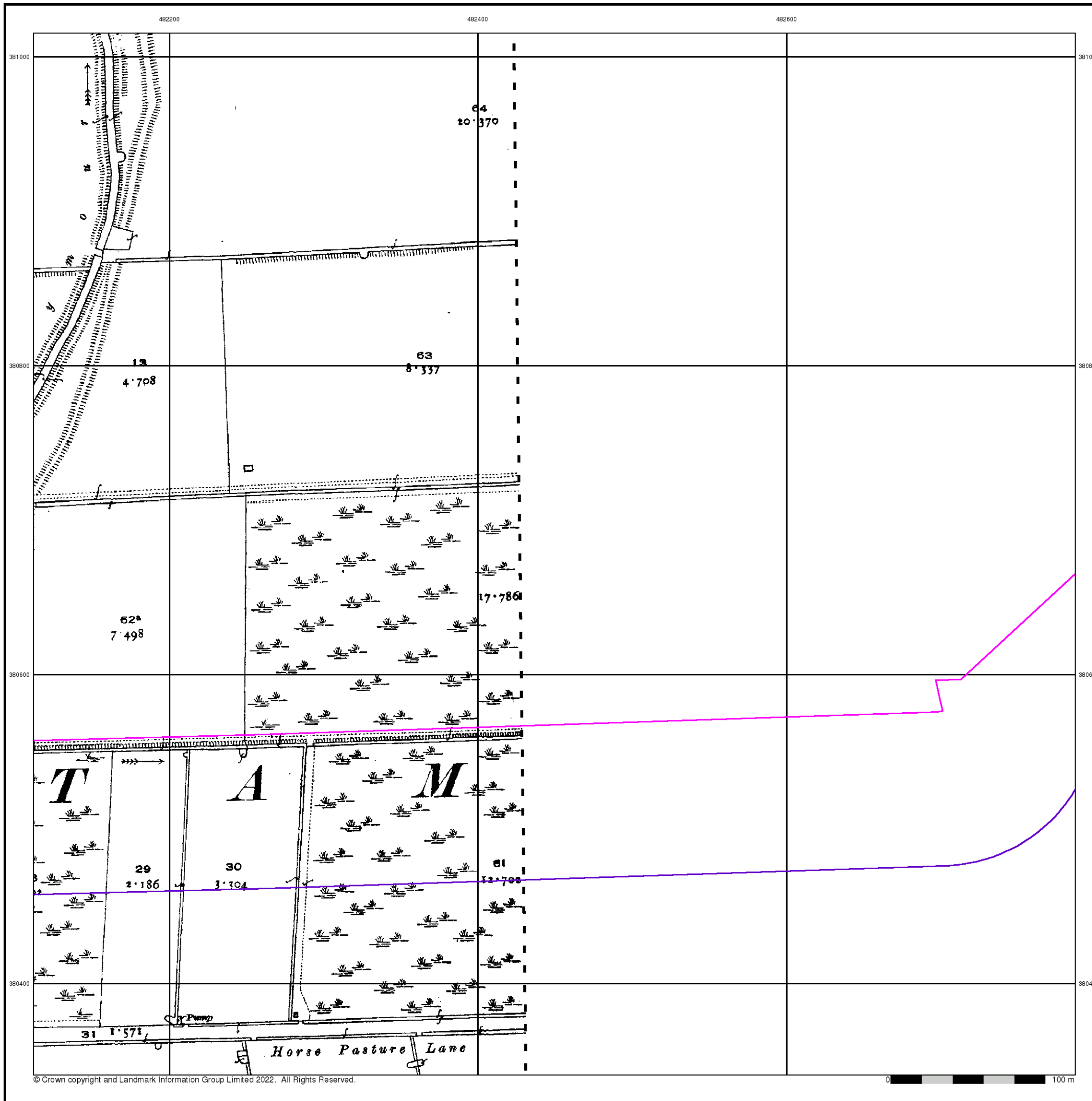

Ordnance Survey Plan
Published 1974 - 1975
Source map scale - 1:2,500

The historical maps shown were reproduced from maps predominantly held at the scale adopted for England, Wales and Scotland in the 1840's. In 1854 the 1:2,500 scale was adopted for mapping urban areas and by 1896 it covered the whole of what were considered to be the cultivated parts of Great Britain. The published date given below is often some years later than the surveyed date. Before 1938, all OS maps were based on the Cassini Projection, with independent surveys of a single county or group of counties, giving rise to significant inaccuracies in outlying areas.

Map Name(s) and Date(s)

SK8281	1975	1:2,500
SK8280	1974	1:2,500

Historical Map - Segment B6

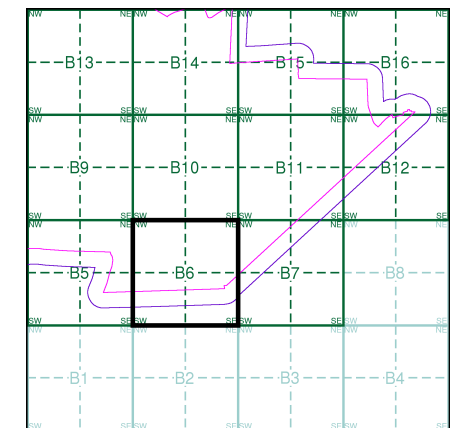

Order Details

Order Number: 298001706_1_1
 Customer Ref: 21-2098.04
 National Grid Reference: 482570, 381420
 Slice: B
 Site Area (Ha): 1355.61
 Search Buffer (m): 100

Site Details

West Barton 2

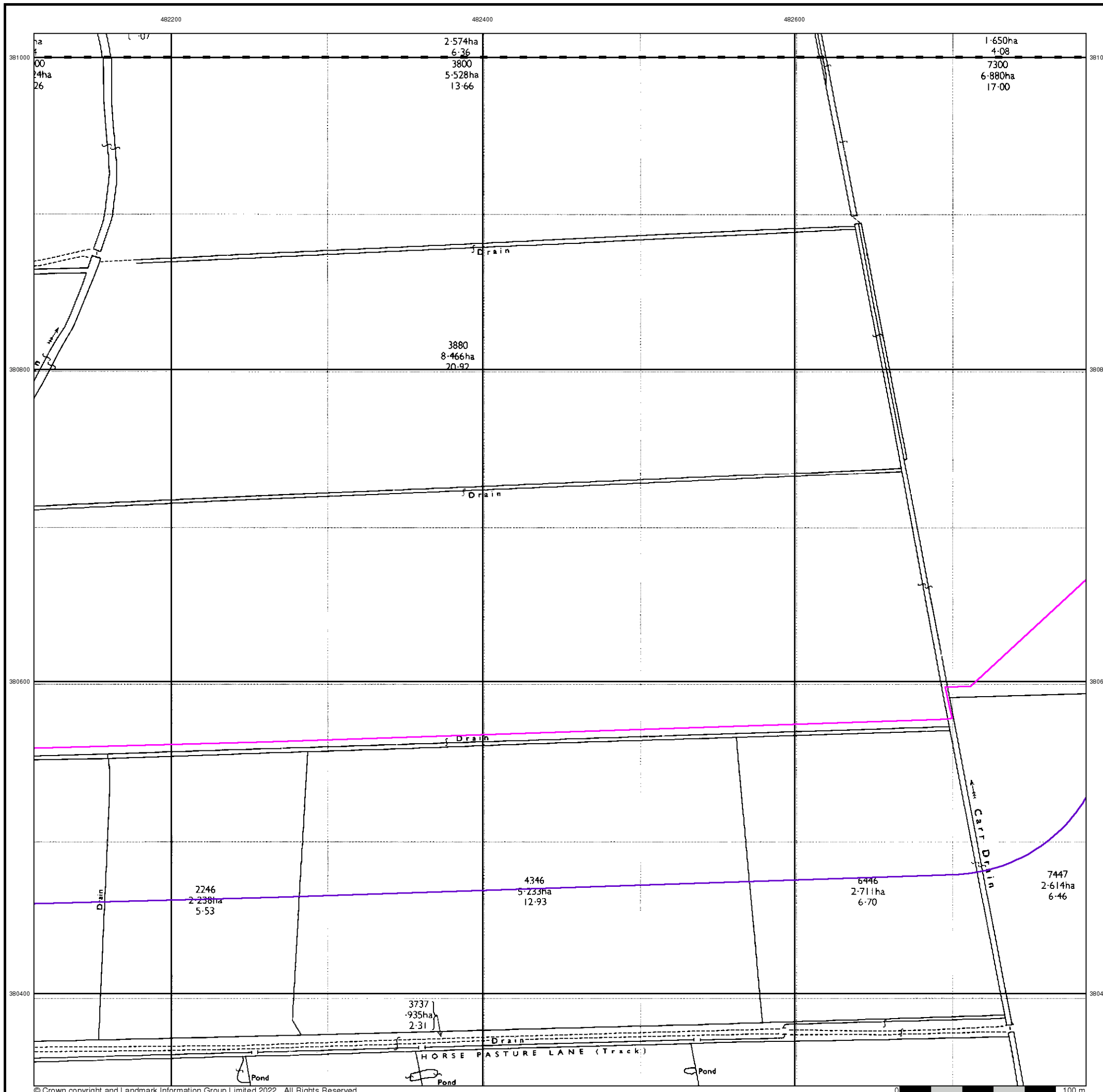

Large-Scale National Grid Data

Published 1994

Source map scale - 1:2,500

'Large Scale National Grid Data' superseded SIM cards (Ordnance Survey's 'Survey of Information on Microfilm') in 1992, and continued to be produced until 1999. These maps were the fore-runners of digital mapping and so provide detailed information on houses and roads, but tend to show less topographic features such as vegetation. These maps were produced at both 1:2,500 and 1:1,250 scales.

Map Name(s) and Date(s)

SK8281	1994	1:2,500
SK8280	1994	1:2,500

Historical Map - Segment B6

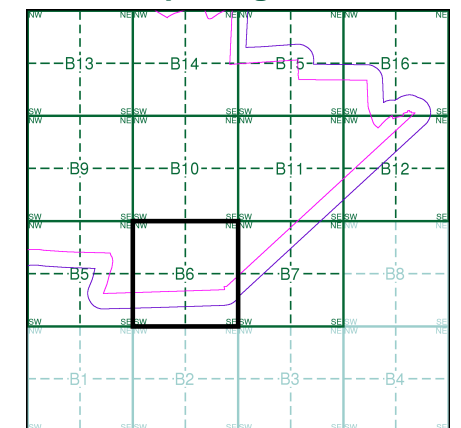

Order Details

Order Number: 298001706_1_1
 Customer Ref: 21-2098.04
 National Grid Reference: 482570, 381420
 Slice: B
 Site Area (Ha): 1355.61
 Search Buffer (m): 100

Site Details

West Barton 2

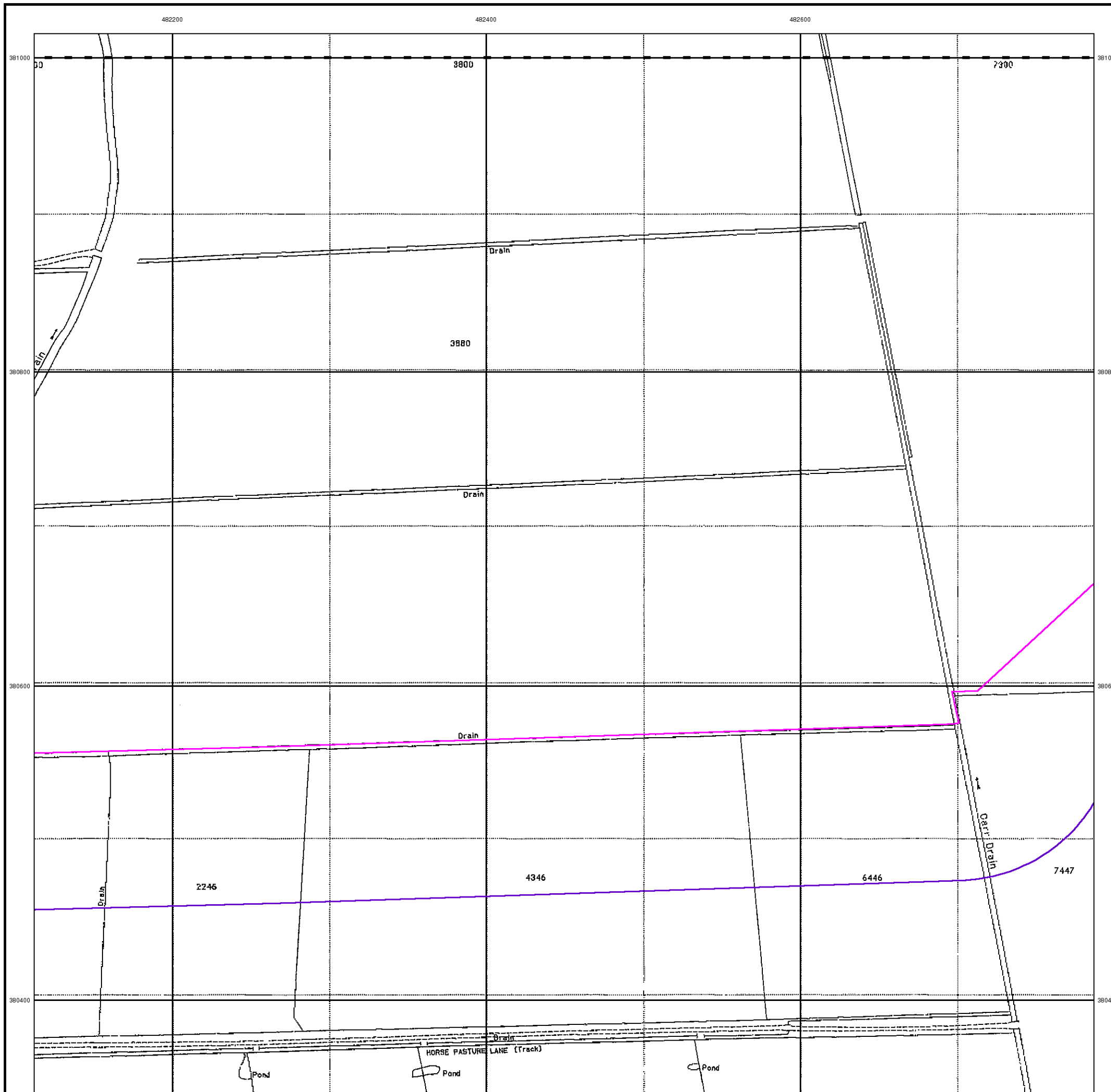

Historical Mapping Legends

Ordnance Survey County Series and Ordnance Survey Plan 1:2,500

Quarry **Gravel Pit** **Sand Pit**
Clay Pit **Shingle** **Refuse Heap**
Sloping Masonry **Flat Rock**
Marsh **Reeds** **Osiers**
Rough Pasture **Furze** **Wood**
Mixed Wood **Brushwood** **Orchard**
Fir **Ford** **Stepping Stones**
Ferry **Waterfall** **Lock**
Trig. Station **Altitude at Trig. Station**
B.M. 325.9 **Bench Mark** **Surface Level**
Arrow denotes flow of water **Antiquities (site of)**
Cutting **Embankment**
Railway crossing Road **Level Crossing** **Road crossing Railway**
Railway crossing River or Canal **Road over single stream** **Road over River or Canal**
County Boundary (Geographical)
County & Civil Parish Boundary
Administrative County & Civil Parish Boundary
County Borough Boundary (England)
County Burgh Boundary (Scotland)
Boundary Post or Stone **Police Call Box**
B.R. Bridle Road **Pump**
E.P. Electricity Pylon **S.P. Signal Post**
F.B. Foot Bridge **Sl. Sluice**
F.P. Foot Path **Sp. Spring**
G.P. Guide Post or Board **T.C.B. Telephone Call Box**
M.S. Mile Stone **Tr. Trough**
M.P. M.R. Mooring Post or Ring **W. Well**

Ordnance Survey Plan, Additional SIMs and Supply of Unpublished Survey Information 1:2,500 and 1:1,250

Inactive Quarry, Chalk Pit or Clay Pit **Active Quarry, Chalk Pit or Clay Pit**
Rock **Boulders**
Cliff **Slopes** **Top**
Roofed Building **Glazed Roof Building**
Sloping Masonry **Archway**
Non-Coniferous Tree (surveyed) **Coniferous Tree (surveyed)**
Non-Coniferous Trees (not surveyed) **Coniferous Trees (not surveyed)**
Orchard Tree **Scrub** **Bracken**
Coppice, Osier **Reeds** **Marsh, Saltings**
Rough Grassland **Heath** **Culvert**
Direction of water flow **Bench Mark** **Antiquity (site of)**
Cave Entrance **Triangulation Station** **Electricity Pylon**
Electricity Transmission Line
County Boundary (Geographical)
County & Civil Parish Boundary
Civil Parish Boundary
Admin. County or County Bor. Boundary
London Borough Boundary
Symbol marking point where boundary mereing changes
Beer House **Pillar, Pole or Post**
Boundary Post or Stone **Post Office**
Capstan, Crane **Public Convenience**
Chimney **Public House**
Drinking Fountain **Pump**
Electricity Pillar or Post **Signal Box or Bridge**
Fire Alarm Pillar **Signal Post or Light**
Foot Bridge **Spring**
Guide Post **Tank or Track**
Hydrant or Hydraulic **Telephone Call Box**
Level Crossing **Telephone Call Post**
Manhole **Trough**
Mile Post or Mooring Post **Water Point, Water Tap**
Mile Stone **Well**
Normal Tidal Limit **Wind Pump**

Large-Scale National Grid Data 1:2,500 and 1:1,250

Cliff **Slopes** **Top**
Rock **Rock (scattered)**
Boulders **Boulders (scattered)**
Positioned Boulder **Scree**
Non-Coniferous Tree (surveyed) **Coniferous Tree (surveyed)**
Non-Coniferous Trees (not surveyed) **Coniferous Trees (not surveyed)**
Orchard Tree **Scrub** **Bracken**
Coppice, Osier **Reeds** **Marsh, Saltings**
Rough Grassland **Heath** **Culvert**
Direction of water flow **Triangulation Station** **Antiquity (site of)**
Electricity Transmission Line **Electricity Pylon**
Bench Mark **Buildings with Building Seed**
Roofed Building **Glazed Roof Building**
Civil parish/community boundary
District boundary
County boundary
Boundary post/stone
Boundary mereing symbol (note: these always appear in opposed pairs or groups of three)
Barracks **Pillar, Pole or Post**
Battery **Post Office**
Cemetery **Public Convenience**
Chimney **Pump**
Cistern **Pumping Station**
Dismtd Rly **Place of Worship**
Electricity Generating Station **Sewage Ppg Sta** **Sewage Pumping Station**
Electricity Pole, Pillar **Signal Box or Bridge**
Electricity Sub Station **Signal Post or Light**
Filter Bed **Spring**
Fountain / Drinking Ftn. **Tank or Track**
Gas Valve Compound **Trough**
Gas Governor **Wind Pump**
Guide Post **Water Point, Water Tap**
Manhole **Works (building or area)**
Mile Post or Mile Stone **Well**



Historical Mapping & Photography included:

Mapping Type	Scale	Date	Pg
Lincolnshire	1:2,500	1886	2
Nottinghamshire	1:2,500	1899	3
Lincolnshire	1:2,500	1920	4
Ordnance Survey Plan	1:2,500	1974 - 1975	5
Large-Scale National Grid Data	1:2,500	1994	6

Historical Map - Segment B7

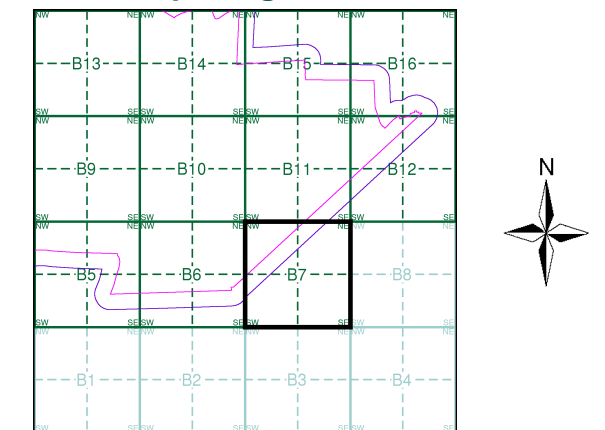

Order Details

Order Number: 298001706_1_1
 Customer Ref: 21-2098.04
 National Grid Reference: 482570, 381420
 Slice: B
 Site Area (Ha): 1355.61
 Search Buffer (m): 100

Site Details

West Barton 2



Tel: 0844 844 9952
 Fax: 0844 844 9951
 Web: [REDACTED]

Lincolnshire

Published 1886

Source map scale - 1:2,500

The historical maps shown were reproduced from maps predominantly held at the scale adopted for England, Wales and Scotland in the 1840's. In 1854 the 1:2,500 scale was adopted for mapping urban areas and by 1896 it covered the whole of what were considered to be the cultivated parts of Great Britain. The published date given below is often some years later than the surveyed date. Before 1938, all OS maps were based on the Cassini Projection, with independent surveys of a single county or group of counties, giving rise to significant inaccuracies in outlying areas.

Map Name(s) and Date(s)

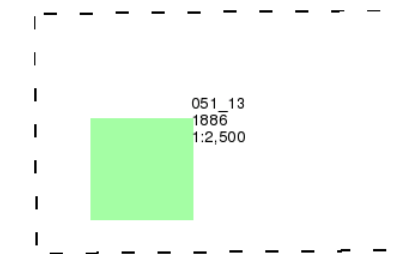

Historical Map - Segment B7

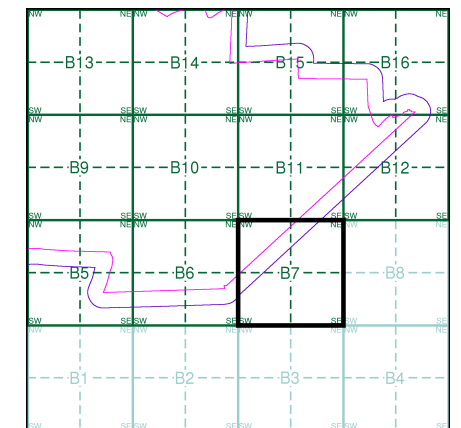

Order Details

Order Number: 298001706_1_1
 Customer Ref: 21-2098.04
 National Grid Reference: 482570, 381420
 Slice: B
 Site Area (Ha): 1355.61
 Search Buffer (m): 100

Site Details

West Barton 2

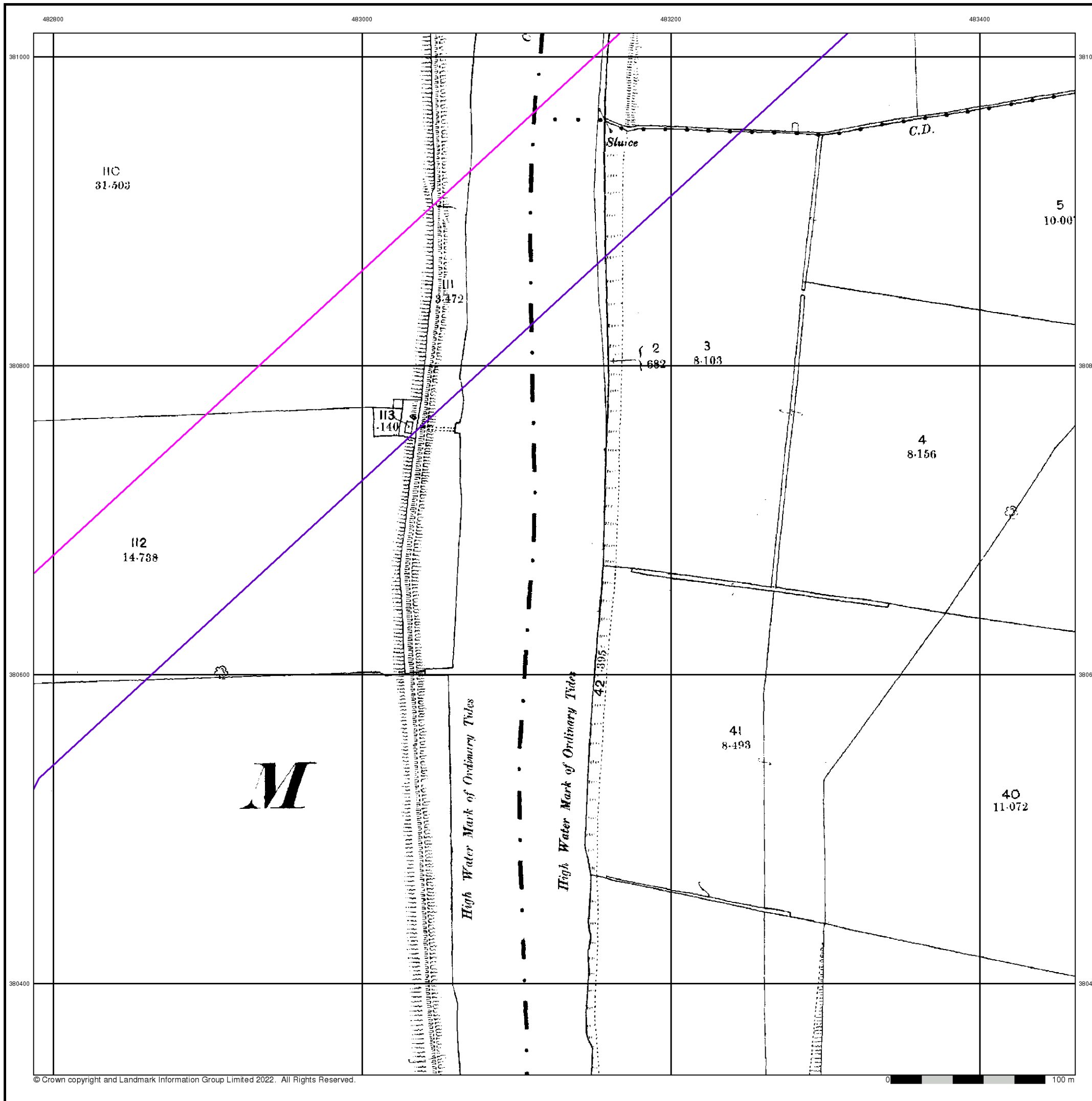

Nottinghamshire

Published 1899

Source map scale - 1:2,500

The historical maps shown were reproduced from maps predominantly held at the scale adopted for England, Wales and Scotland in the 1840's. In 1854 the 1:2,500 scale was adopted for mapping urban areas and by 1896 it covered the whole of what were considered to be the cultivated parts of Great Britain. The published date given below is often some years later than the surveyed date. Before 1938, all OS maps were based on the Cassini Projection, with independent surveys of a single county or group of counties, giving rise to significant inaccuracies in outlying areas.

Map Name(s) and Date(s)

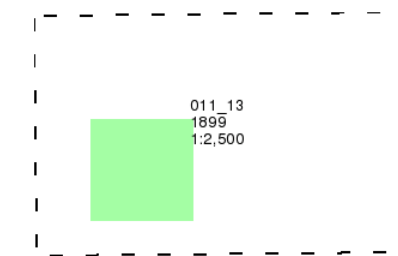

Historical Map - Segment B7

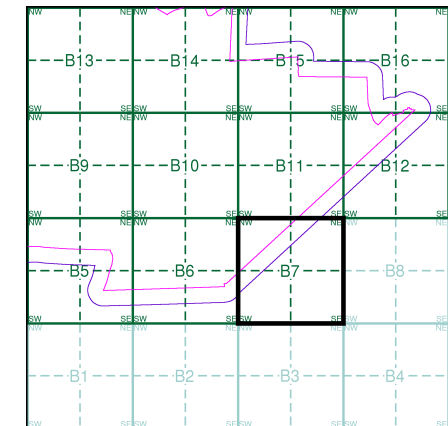

Order Details

Order Number: 298001706_1_1
 Customer Ref: 21-2098.04
 National Grid Reference: 482570, 381420
 Slice: B
 Site Area (Ha): 1355.61
 Search Buffer (m): 100

Site Details

West Barton 2

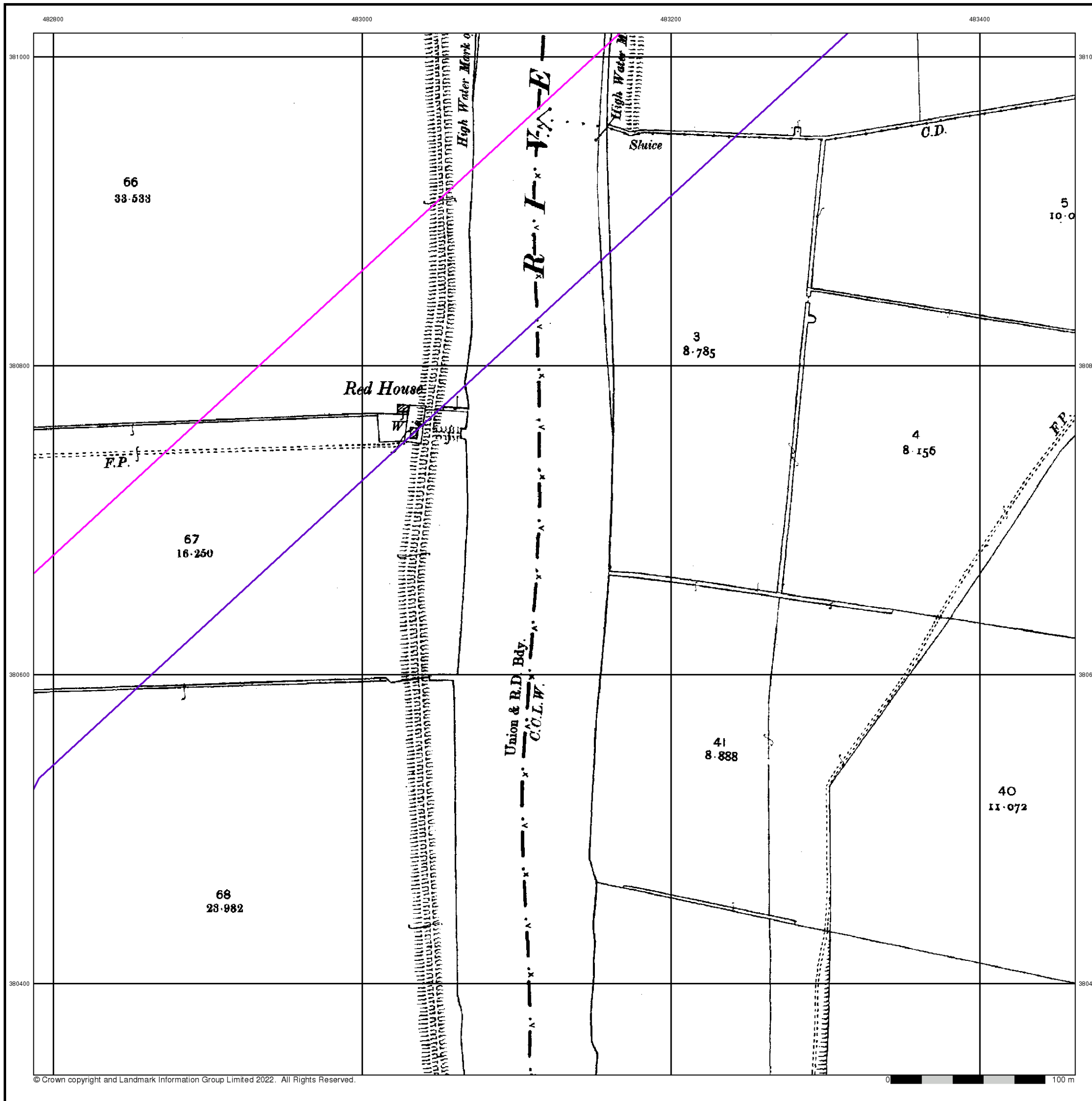

Lincolnshire

Published 1920

Source map scale - 1:2,500

The historical maps shown were reproduced from maps predominantly held at the scale adopted for England, Wales and Scotland in the 1840's. In 1854 the 1:2,500 scale was adopted for mapping urban areas and by 1896 it covered the whole of what were considered to be the cultivated parts of Great Britain. The published date given below is often some years later than the surveyed date. Before 1938, all OS maps were based on the Cassini Projection, with independent surveys of a single county or group of counties, giving rise to significant inaccuracies in outlying areas.

Map Name(s) and Date(s)

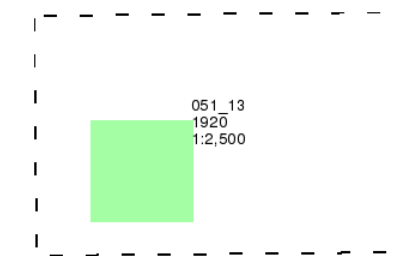

Historical Map - Segment B7

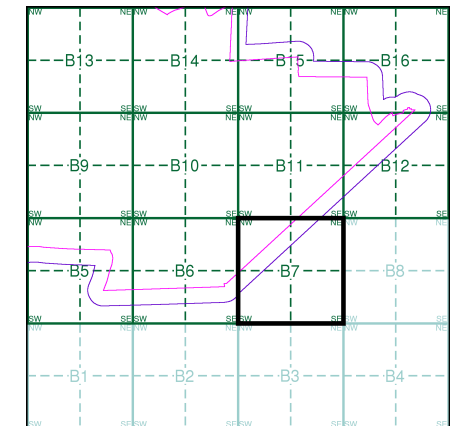

Order Details

Order Number: 298001706_1_1
 Customer Ref: 21-2098.04
 National Grid Reference: 482570, 381420
 Slice: B
 Site Area (Ha): 1355.61
 Search Buffer (m): 100

Site Details

West Barton 2

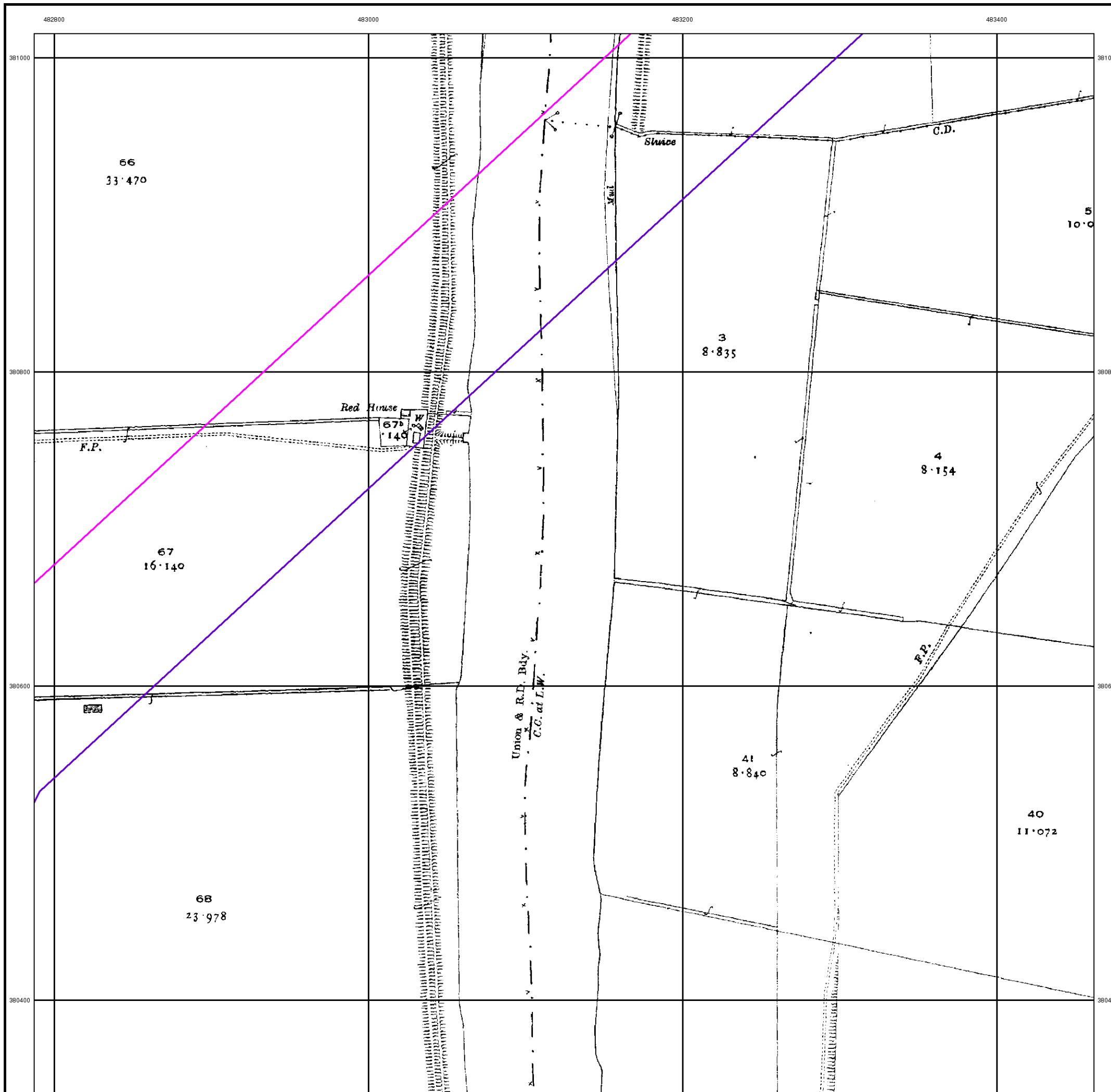

Ordnance Survey Plan
Published 1974 - 1975
Source map scale - 1:2,500

The historical maps shown were reproduced from maps predominantly held at the scale adopted for England, Wales and Scotland in the 1840's. In 1854 the 1:2,500 scale was adopted for mapping urban areas and by 1896 it covered the whole of what were considered to be the cultivated parts of Great Britain. The published date given below is often some years later than the surveyed date. Before 1938, all OS maps were based on the Cassini Projection, with independent surveys of a single county or group of counties, giving rise to significant inaccuracies in outlying areas.

Map Name(s) and Date(s)

SK8281 1975 1:2,500	SK8381 1975 1:2,500
SK8280 1974 1:2,500	SK8380 1974 1:2,500

Historical Map - Segment B7

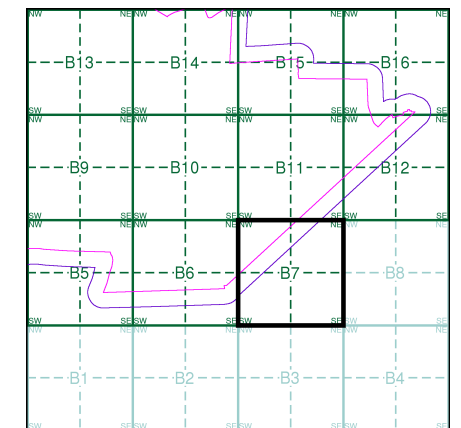

Order Details

Order Number: 298001706_1_1
 Customer Ref: 21-2098.04
 National Grid Reference: 482570, 381420
 Slice: B
 Site Area (Ha): 1355.61
 Search Buffer (m): 100

Site Details

West Barton 2

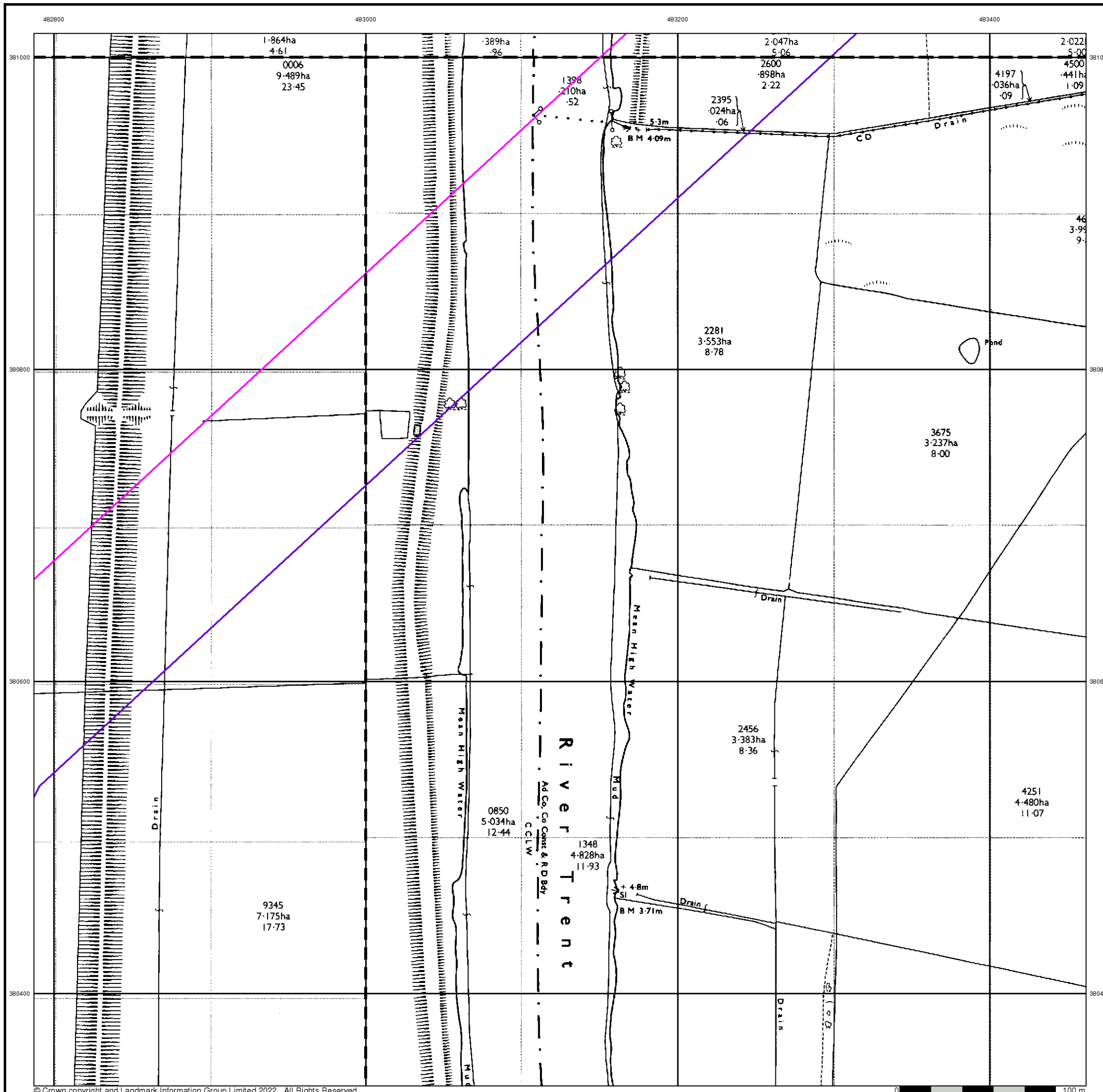

Large-Scale National Grid Data

Published 1994

Source map scale - 1:2,500

'Large Scale National Grid Data' superseded SIM cards (Ordnance Survey's 'Survey of Information on Microfilm') in 1992, and continued to be produced until 1999. These maps were the fore-runners of digital mapping and so provide detailed information on houses and roads, but tend to show less topographic features such as vegetation. These maps were produced at both 1:2,500 and 1:1,250 scales.

Map Name(s) and Date(s)

SK8281	SK8381
1994	1994
1:2,500	1:2,500
SK8280	SK8380
1994	1994
1:2,500	1:2,500

Historical Map - Segment B7

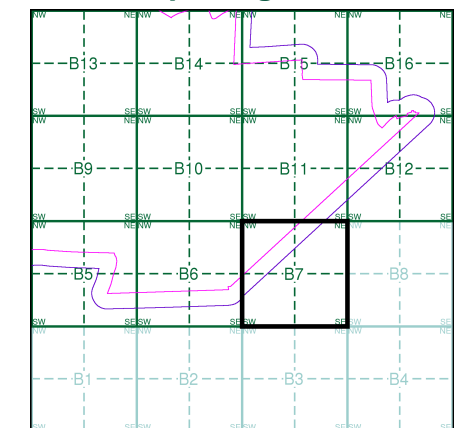

Order Details

Order Number: 298001706_1_1
 Customer Ref: 21-2098.04
 National Grid Reference: 482570, 381420
 Slice: B
 Site Area (Ha): 1355.61
 Search Buffer (m): 100

Site Details

West Barton 2

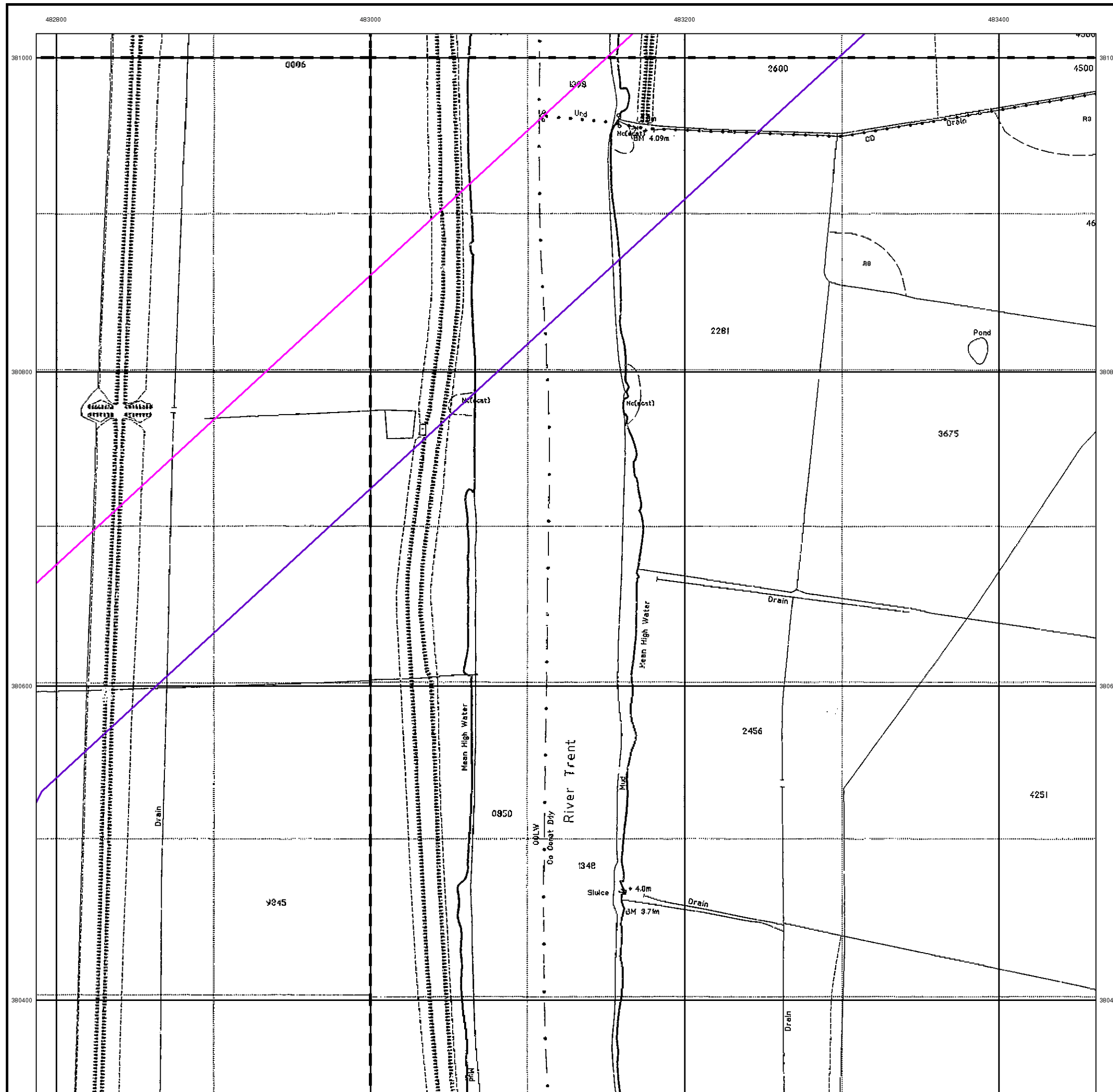

Historical Mapping Legends

Ordnance Survey County Series and Ordnance Survey Plan 1:2,500

Quarry **Gravel Pit** **Sand Pit**
Clay Pit **Shingle** **Refuse Heap**
Sloping Masonry **Flat Rock**
Marsh **Reeds** **Osiers**
Rough Pasture **Furze** **Wood**
Mixed Wood **Brushwood** **Orchard**
Fir **Ford** **Stepping Stones**
Ferry **Waterfall** **Lock**
Trig. Station **Altitude at Trig. Station**
B.M. 325.9 **Bench Mark** **Surface Level**
Arrow denotes flow of water **Antiquities (site of)**
Cutting **Embankment**
Railway crossing Road **Level Crossing** **Road crossing Railway**
Railway crossing River or Canal **Road over single stream** **Road over River or Canal**
County Boundary (Geographical)
County & Civil Parish Boundary
Administrative County & Civil Parish Boundary
County Borough Boundary (England)
County Burgh Boundary (Scotland)
Boundary Post or Stone **Police Call Box**
B.R. Bridle Road **Pump**
E.P. Electricity Pylon **S.P. Signal Post**
F.B. Foot Bridge **Sl. Sluice**
F.P. Foot Path **Sp. Spring**
G.P. Guide Post or Board **T.C.B. Telephone Call Box**
M.S. Mile Stone **Tr. Trough**
M.P. M.R. Mooring Post or Ring **W. Well**

Ordnance Survey Plan, Additional SIMs and Supply of Unpublished Survey Information 1:2,500 and 1:1,250

Inactive Quarry, Chalk Pit or Clay Pit **Active Quarry, Chalk Pit or Clay Pit**
Rock **Boulders**
Cliff **Slopes** **Top**
Roofed Building **Glazed Roof Building**
Sloping Masonry **Archway**
Non-Coniferous Tree (surveyed) **Coniferous Tree (surveyed)**
Non-Coniferous Trees (not surveyed) **Coniferous Trees (not surveyed)**
Orchard Tree **Scrub** **Bracken**
Coppice, Osier **Reeds** **Marsh, Saltings**
Rough Grassland **Heath** **Culvert**
Direction of water flow **Bench Mark** **Antiquity (site of)**
Cave Entrance **Triangulation Station** **Electricity Pylon**
Electricity Transmission Line
County Boundary (Geographical)
County & Civil Parish Boundary
Civil Parish Boundary
Admin. County or County Bor. Boundary
London Borough Boundary
Symbol marking point where boundary mereing changes
Beer House **Pillar, Pole or Post**
Boundary Post or Stone **Post Office**
Capstan, Crane **Public Convenience**
Chimney **Public House**
Drinking Fountain **Pump**
Electricity Pillar or Post **Signal Box or Bridge**
Fire Alarm Pillar **Signal Post or Light**
Foot Bridge **Spring**
Guide Post **Tank or Track**
Hydrant or Hydraulic **Telephone Call Box**
Level Crossing **Telephone Call Post**
Manhole **Trough**
Mile Post or Mooring Post **Water Point, Water Tap**
Mile Stone **Well**
Normal Tidal Limit **Wind Pump**

Large-Scale National Grid Data 1:2,500 and 1:1,250

Cliff **Slopes** **Top**
Rock **Rock (scattered)**
Boulders **Boulders (scattered)**
Positioned Boulder **Scree**
Non-Coniferous Tree (surveyed) **Coniferous Tree (surveyed)**
Non-Coniferous Trees (not surveyed) **Coniferous Trees (not surveyed)**
Orchard Tree **Scrub** **Bracken**
Coppice, Osier **Reeds** **Marsh, Saltings**
Rough Grassland **Heath** **Culvert**
Direction of water flow **Triangulation Station** **Antiquity (site of)**
Electricity Transmission Line **Electricity Pylon**
Bench Mark **Buildings with Building Seed**
Roofed Building **Glazed Roof Building**
Civil parish/community boundary
District boundary
County boundary
Boundary post/stone
Boundary mereing symbol (note: these always appear in opposed pairs or groups of three)
Barracks **Pillar, Pole or Post**
Battery **Post Office**
Cemetery **Public Convenience**
Chimney **Pump**
Cistern **Pumping Station**
Dismtd Rly **Place of Worship**
Electricity Generating Station **Sewage Ppg Sta** **Sewage Pumping Station**
Electricity Pole, Pillar **Signal Box or Bridge**
Electricity Sub Station **Signal Post or Light**
Filter Bed **Spring**
Fountain / Drinking Ftn. **Tank or Track**
Gas Valve Compound **Trough**
Gas Governor **Wind Pump**
Guide Post **Water Point, Water Tap**
Manhole **Works (building or area)**
Mile Post or Mile Stone **Well**



Historical Mapping & Photography included:

Mapping Type	Scale	Date	Pg
Nottinghamshire	1:2,500	1886	2
Nottinghamshire	1:2,500	1899	3
Nottinghamshire	1:2,500	1920	4
Ordnance Survey Plan	1:2,500	1974 - 1975	5
Large-Scale National Grid Data	1:2,500	1994	6

Historical Map - Segment B9

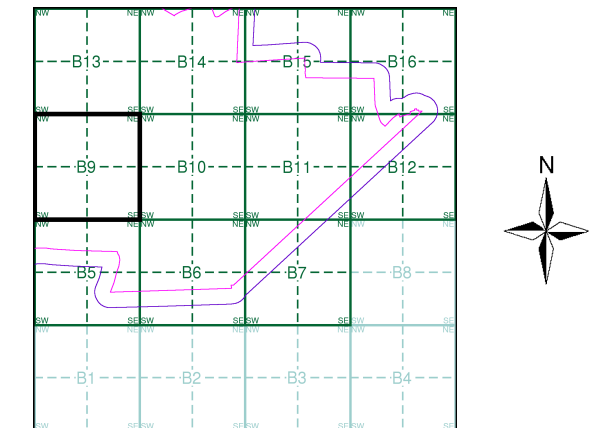

Order Details

Order Number: 298001706_1_1
 Customer Ref: 21-2098.04
 National Grid Reference: 482570, 381420
 Slice: B
 Site Area (Ha): 1355.61
 Search Buffer (m): 100

Site Details

West Barton 2



Tel: 0844 844 9952
 Fax: 0844 844 9951
 Web: [REDACTED]

Nottinghamshire

Published 1886

Source map scale - 1:2,500

The historical maps shown were reproduced from maps predominantly held at the scale adopted for England, Wales and Scotland in the 1840's. In 1854 the 1:2,500 scale was adopted for mapping urban areas and by 1896 it covered the whole of what were considered to be the cultivated parts of Great Britain. The published date given below is often some years later than the surveyed date. Before 1938, all OS maps were based on the Cassini Projection, with independent surveys of a single county or group of counties, giving rise to significant inaccuracies in outlying areas.

Map Name(s) and Date(s)

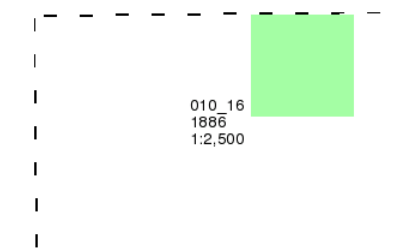

Historical Map - Segment B9

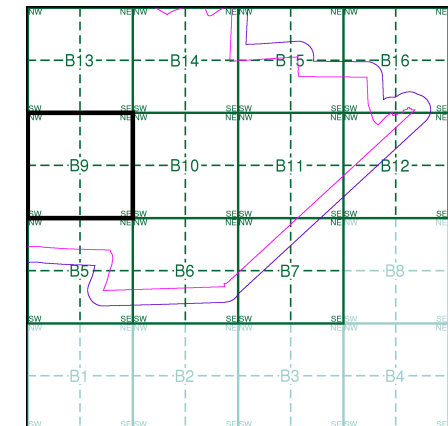

Order Details

Order Number: 298001706_1_1
 Customer Ref: 21-2098.04
 National Grid Reference: 482570, 381420
 Slice: B
 Site Area (Ha): 1355.61
 Search Buffer (m): 100

Site Details

West Barton 2

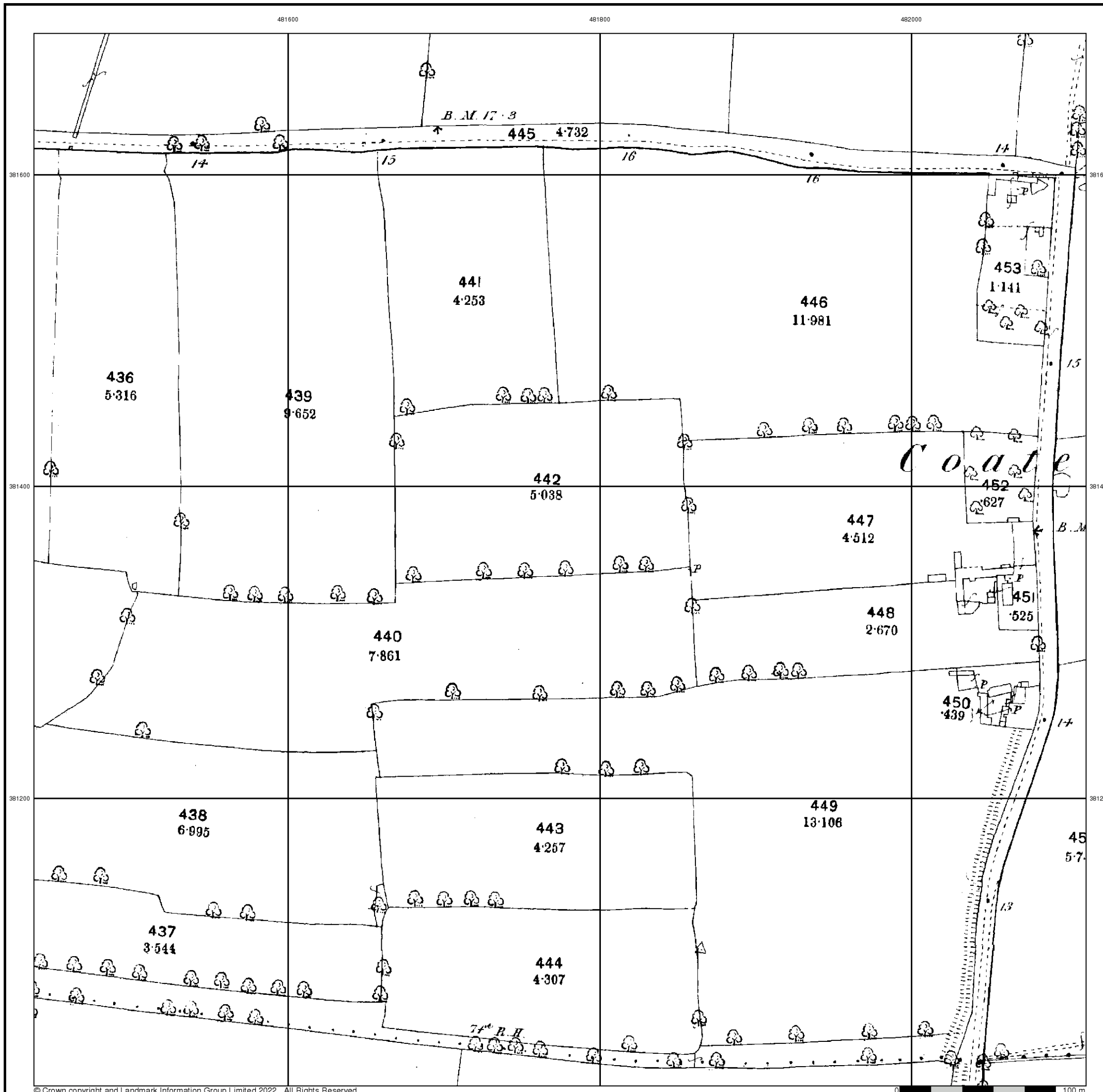

Nottinghamshire

Published 1899

Source map scale - 1:2,500

The historical maps shown were reproduced from maps predominantly held at the scale adopted for England, Wales and Scotland in the 1840's. In 1854 the 1:2,500 scale was adopted for mapping urban areas and by 1896 it covered the whole of what were considered to be the cultivated parts of Great Britain. The published date given below is often some years later than the surveyed date. Before 1938, all OS maps were based on the Cassini Projection, with independent surveys of a single county or group of counties, giving rise to significant inaccuracies in outlying areas.

Map Name(s) and Date(s)

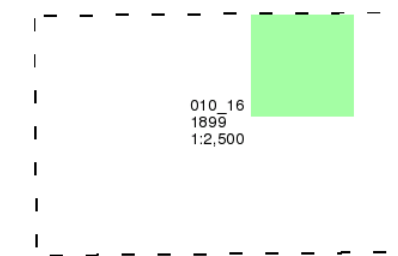

Historical Map - Segment B9

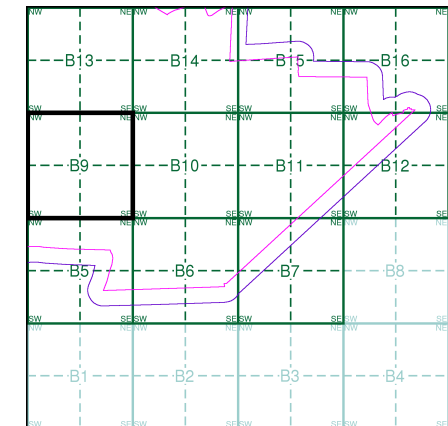

Order Details

Order Number: 298001706_1_1
 Customer Ref: 21-2098.04
 National Grid Reference: 482570, 381420
 Slice: B
 Site Area (Ha): 1355.61
 Search Buffer (m): 100

Site Details

West Barton 2



Nottinghamshire

Published 1920

Source map scale - 1:2,500

The historical maps shown were reproduced from maps predominantly held at the scale adopted for England, Wales and Scotland in the 1840's. In 1854 the 1:2,500 scale was adopted for mapping urban areas and by 1896 it covered the whole of what were considered to be the cultivated parts of Great Britain. The published date given below is often some years later than the surveyed date. Before 1938, all OS maps were based on the Cassini Projection, with independent surveys of a single county or group of counties, giving rise to significant inaccuracies in outlying areas.

Map Name(s) and Date(s)

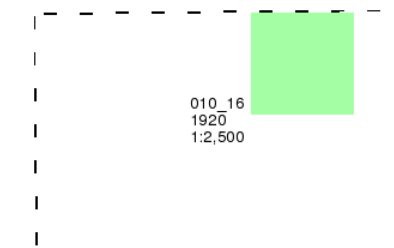

Historical Map - Segment B9

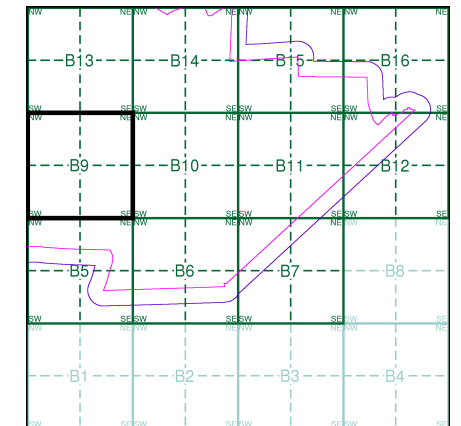

Order Details

Order Number: 298001706_1_1
 Customer Ref: 21-2098.04
 National Grid Reference: 482570, 381420
 Slice: B
 Site Area (Ha): 1355.61
 Search Buffer (m): 100

Site Details

West Barton 2



Ordnance Survey Plan
Published 1974 - 1975
Source map scale - 1:2,500

The historical maps shown were reproduced from maps predominantly held at the scale adopted for England, Wales and Scotland in the 1840's. In 1854 the 1:2,500 scale was adopted for mapping urban areas and by 1896 it covered the whole of what were considered to be the cultivated parts of Great Britain. The published date given below is often some years later than the surveyed date. Before 1938, all OS maps were based on the Cassini Projection, with independent surveys of a single county or group of counties, giving rise to significant inaccuracies in outlying areas.

Map Name(s) and Date(s)

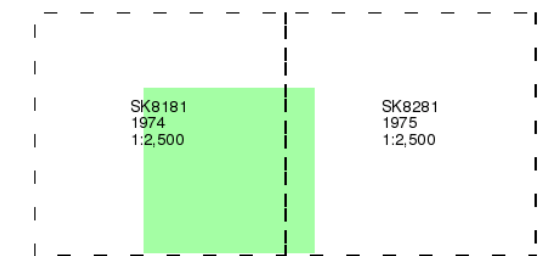

Historical Map - Segment B9

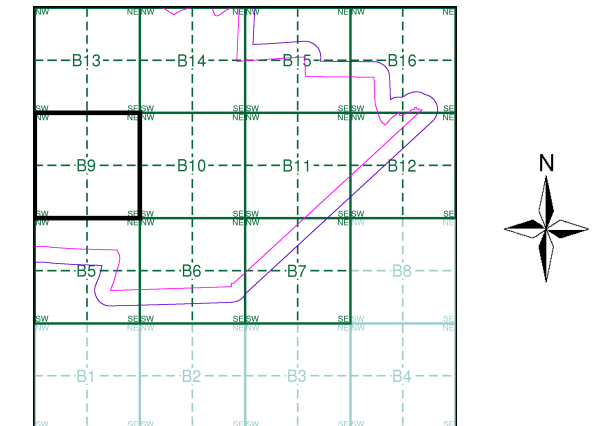

Order Details

Order Number: 298001706_1_1
 Customer Ref: 21-2098.04
 National Grid Reference: 482570, 381420
 Slice: B
 Site Area (Ha): 1355.61
 Search Buffer (m): 100

Site Details

West Barton 2



Large-Scale National Grid Data
Published 1994
Source map scale - 1:2,500

'Large Scale National Grid Data' superseded SIM cards (Ordnance Survey's 'Survey of Information on Microfilm') in 1992, and continued to be produced until 1999. These maps were the fore-runners of digital mapping and so provide detailed information on houses and roads, but tend to show less topographic features such as vegetation. These maps were produced at both 1:2,500 and 1:1,250 scales.

Map Name(s) and Date(s)

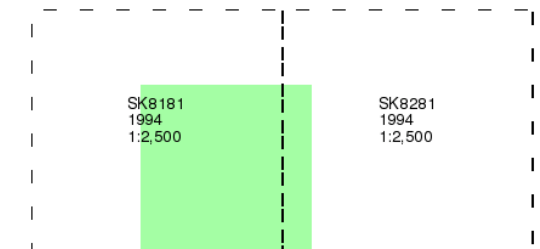

Historical Map - Segment B9

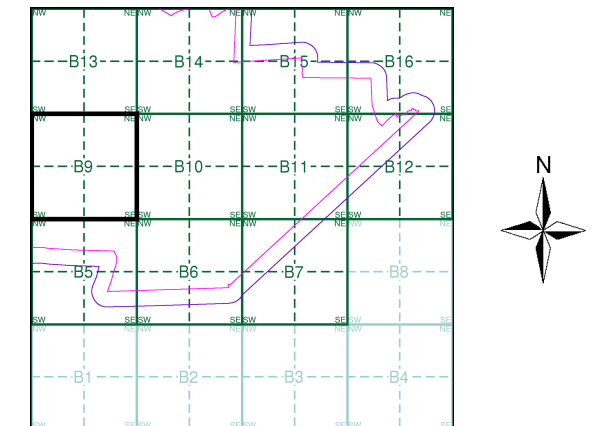

Order Details

Order Number: 298001706_1_1
 Customer Ref: 21-2098.04
 National Grid Reference: 482570, 381420
 Slice: B
 Site Area (Ha): 1355.61
 Search Buffer (m): 100

Site Details

West Barton 2



Historical Mapping Legends

Ordnance Survey County Series and Ordnance Survey Plan 1:2,500

Quarry **Gravel Pit** **Sand Pit**
Clay Pit **Shingle** **Refuse Heap**
Sloping Masonry **Flat Rock**
Marsh **Reeds** **Osiers**
Rough Pasture **Furze** **Wood**
Mixed Wood **Brushwood** **Orchard**
Fir **Ford** **Stepping Stones**
Ferry **Waterfall** **Lock**
Trig. Station **Altitude at Trig. Station**
B.M. 325.9 **Bench Mark** **Surface Level**
Arrow denotes flow of water **Antiquities (site of)**
Cutting **Embankment**
Railway crossing Road **Level Crossing** **Road crossing Railway**
Railway crossing River or Canal **Road over single stream** **Road over River or Canal**
County Boundary (Geographical)
County & Civil Parish Boundary
Administrative County & Civil Parish Boundary
County Borough Boundary (England)
County Burgh Boundary (Scotland)
Boundary Post or Stone **Police Call Box**
B.R. Bridle Road **Pump**
E.P. Electricity Pylon **S.P. Signal Post**
F.B. Foot Bridge **Sl. Sluice**
F.P. Foot Path **Sp. Spring**
G.P. Guide Post or Board **T.C.B. Telephone Call Box**
M.S. Mile Stone **Tr. Trough**
M.P. M.R. Mooring Post or Ring **W. Well**

Ordnance Survey Plan, Additional SIMs and Supply of Unpublished Survey Information 1:2,500 and 1:1,250

Inactive Quarry, Chalk Pit or Clay Pit **Active Quarry, Chalk Pit or Clay Pit**
Rock **Boulders**
Cliff **Slopes** **Top**
Roofed Building **Glazed Roof Building**
Sloping Masonry **Archway**
Non-Coniferous Tree (surveyed) **Coniferous Tree (surveyed)**
Non-Coniferous Trees (not surveyed) **Coniferous Trees (not surveyed)**
Orchard Tree **Scrub** **Bracken**
Coppice, Osier **Reeds** **Marsh, Saltings**
Rough Grassland **Heath** **Culvert**
Direction of water flow **Bench Mark** **Antiquity (site of)**
Cave Entrance **Triangulation Station** **Electricity Pylon**
Electricity Transmission Line
County Boundary (Geographical)
County & Civil Parish Boundary
Civil Parish Boundary
Admin. County or County Bor. Boundary
London Borough Boundary
Symbol marking point where boundary mereing changes
BH Beer House **P Pillar, Pole or Post**
BP, BS Boundary Post or Stone **PO Post Office**
Cn, C Capstan, Crane **PC Public Convenience**
Chy Chimney **PH Public House**
D Fn Drinking Fountain **Pp Pump**
EI P Electricity Pillar or Post **SB, S Br Signal Box or Bridge**
FAP Fire Alarm Pillar **SP, SL Signal Post or Light**
FB Foot Bridge **Spr Spring**
GP Guide Post **Tk Tank or Track**
H Hydrant or Hydraulic **TCB Telephone Call Box**
LC Level Crossing **TCP Telephone Call Post**
MH Manhole **Tr Trough**
MP Mile Post or Mooring Post **Wr Pt, Wr T Water Point, Water Tap**
MS Mile Stone **W Well**
NTL Normal Tidal Limit **Wd Pp Wind Pump**

Large-Scale National Grid Data 1:2,500 and 1:1,250

Cliff **Slopes** **Top**
Rock **Rock (scattered)**
Boulders **Boulders (scattered)**
Positioned Boulder **Scree**
Non-Coniferous Tree (surveyed) **Coniferous Tree (surveyed)**
Non-Coniferous Trees (not surveyed) **Coniferous Trees (not surveyed)**
Orchard Tree **Scrub** **Bracken**
Coppice, Osier **Reeds** **Marsh, Saltings**
Rough Grassland **Heath** **Culvert**
Direction of water flow **Triangulation Station** **Antiquity (site of)**
Electricity Transmission Line **Electricity Pylon**
Bench Mark **Buildings with Building Seed**
Roofed Building **Glazed Roof Building**
Civil parish/community boundary
District boundary
County boundary
Boundary post/stone
Boundary mereing symbol (note: these always appear in opposed pairs or groups of three)
Bks Barracks **P Pillar, Pole or Post**
Bty Battery **PO Post Office**
Cemy Cemetery **PC Public Convenience**
Chy Chimney **Pp Pump**
Cis Cistern **Ppg Sta Pumping Station**
Dismtd Rly Dismantled Railway **PW Place of Worship**
EI Gen Sta Electricity Generating Station **Sewage Ppg Sta Sewage Pumping Station**
EI P Electricity Pole, Pillar **SB, S Br Signal Box or Bridge**
EI Sub Sta Electricity Sub Station **SP, SL Signal Post or Light**
FB Filter Bed **Spr Spring**
Fn / D Fn Fountain / Drinking Ftn. **Tk Tank or Track**
Gas Gov Gas Valve Compound **Tr Trough**
GVC Gas Governor **Wd Pp Wind Pump**
GP Guide Post **Wr Pt, Wr T Water Point, Water Tap**
MH Manhole **Wks Works (building or area)**
MP, MS Mile Post or Mile Stone **W Well**



Historical Mapping & Photography included:

Mapping Type	Scale	Date	Pg
Lincolnshire	1:2,500	1886	2
Nottinghamshire	1:2,500	1886	3
Nottinghamshire	1:2,500	1899	4
Lincolnshire	1:2,500	1920	5
Nottinghamshire	1:2,500	1920	6
Ordnance Survey Plan	1:2,500	1975	7
Large-Scale National Grid Data	1:2,500	1994	8

Historical Map - Segment B10

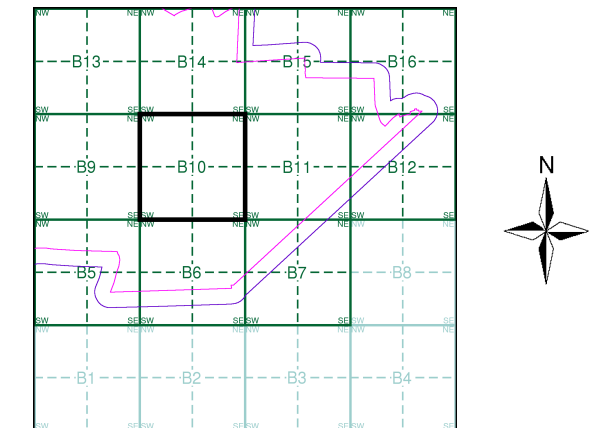

Order Details

Order Number: 298001706_1_1
 Customer Ref: 21-2098.04
 National Grid Reference: 482570, 381420
 Slice: B
 Site Area (Ha): 1355.61
 Search Buffer (m): 100

Site Details

West Barton 2



Tel: 0844 844 9952
 Fax: 0844 844 9951
 Web: [REDACTED]

Lincolnshire

Published 1886

Source map scale - 1:2,500

The historical maps shown were reproduced from maps predominantly held at the scale adopted for England, Wales and Scotland in the 1840's. In 1854 the 1:2,500 scale was adopted for mapping urban areas and by 1896 it covered the whole of what were considered to be the cultivated parts of Great Britain. The published date given below is often some years later than the surveyed date. Before 1938, all OS maps were based on the Cassini Projection, with independent surveys of a single county or group of counties, giving rise to significant inaccuracies in outlying areas.

Map Name(s) and Date(s)

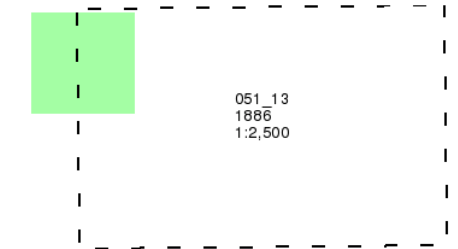

Historical Map - Segment B10

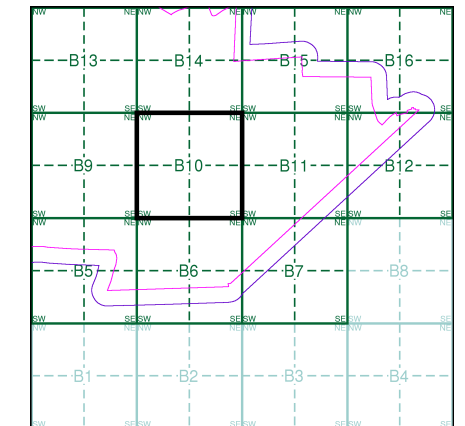

Order Details

Order Number: 298001706_1_1
 Customer Ref: 21-2098.04
 National Grid Reference: 482570, 381420
 Slice: B
 Site Area (Ha): 1355.61
 Search Buffer (m): 100

Site Details

West Barton 2

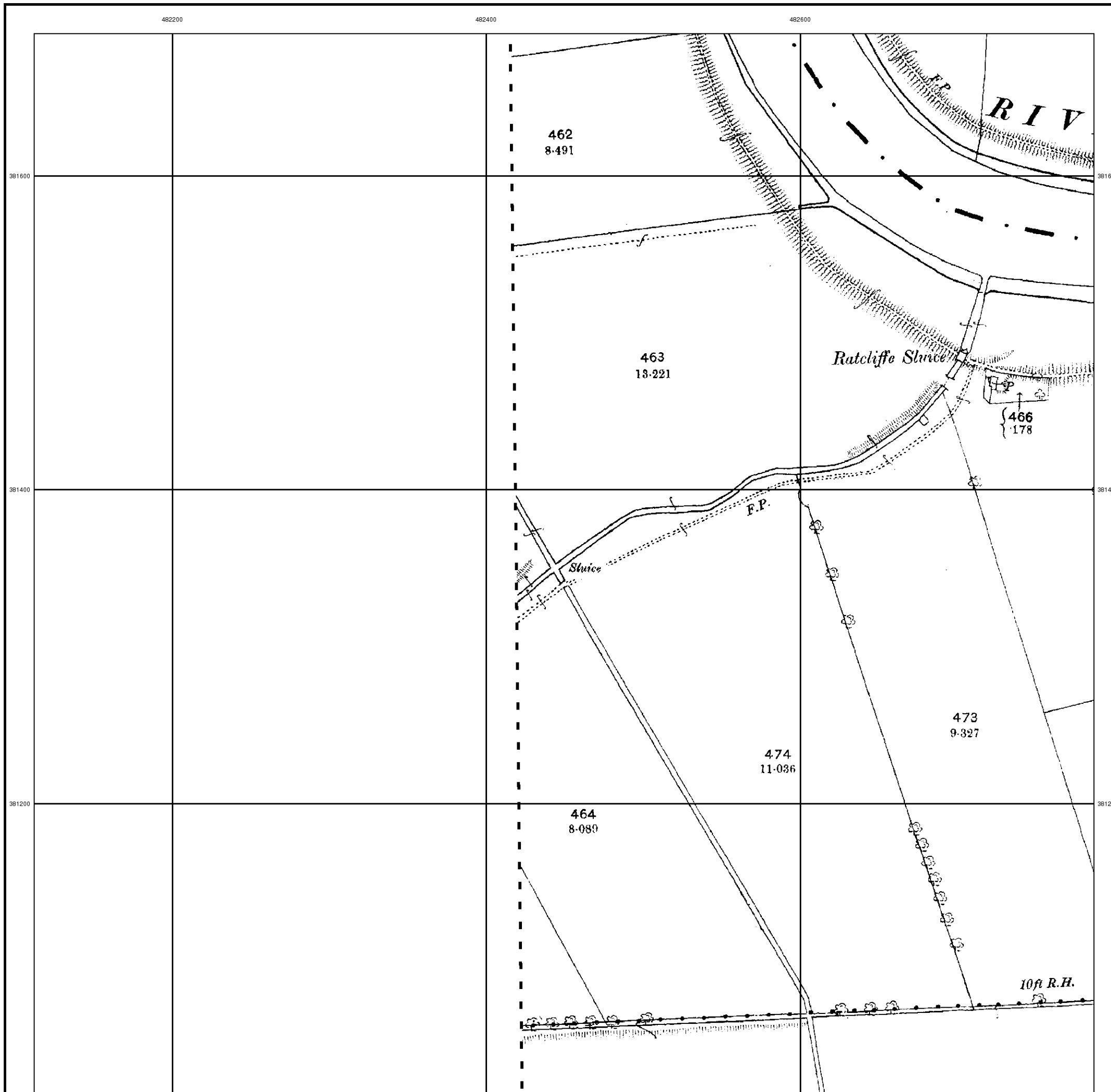

Nottinghamshire

Published 1886

Source map scale - 1:2,500

The historical maps shown were reproduced from maps predominantly held at the scale adopted for England, Wales and Scotland in the 1840's. In 1854 the 1:2,500 scale was adopted for mapping urban areas and by 1896 it covered the whole of what were considered to be the cultivated parts of Great Britain. The published date given below is often some years later than the surveyed date. Before 1938, all OS maps were based on the Cassini Projection, with independent surveys of a single county or group of counties, giving rise to significant inaccuracies in outlying areas.

Map Name(s) and Date(s)

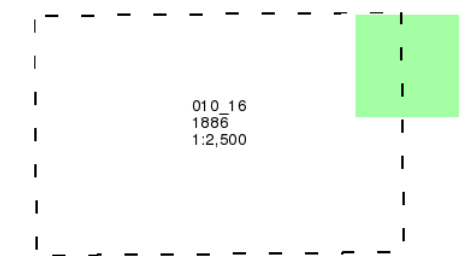

Historical Map - Segment B10

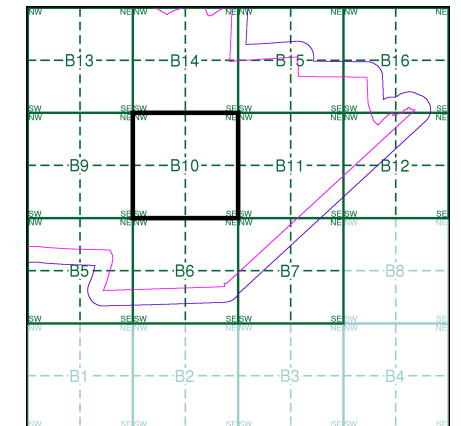

Order Details

Order Number: 298001706_1_1
 Customer Ref: 21-2098.04
 National Grid Reference: 482570, 381420
 Slice: B
 Site Area (Ha): 1355.61
 Search Buffer (m): 100

Site Details

West Barton 2

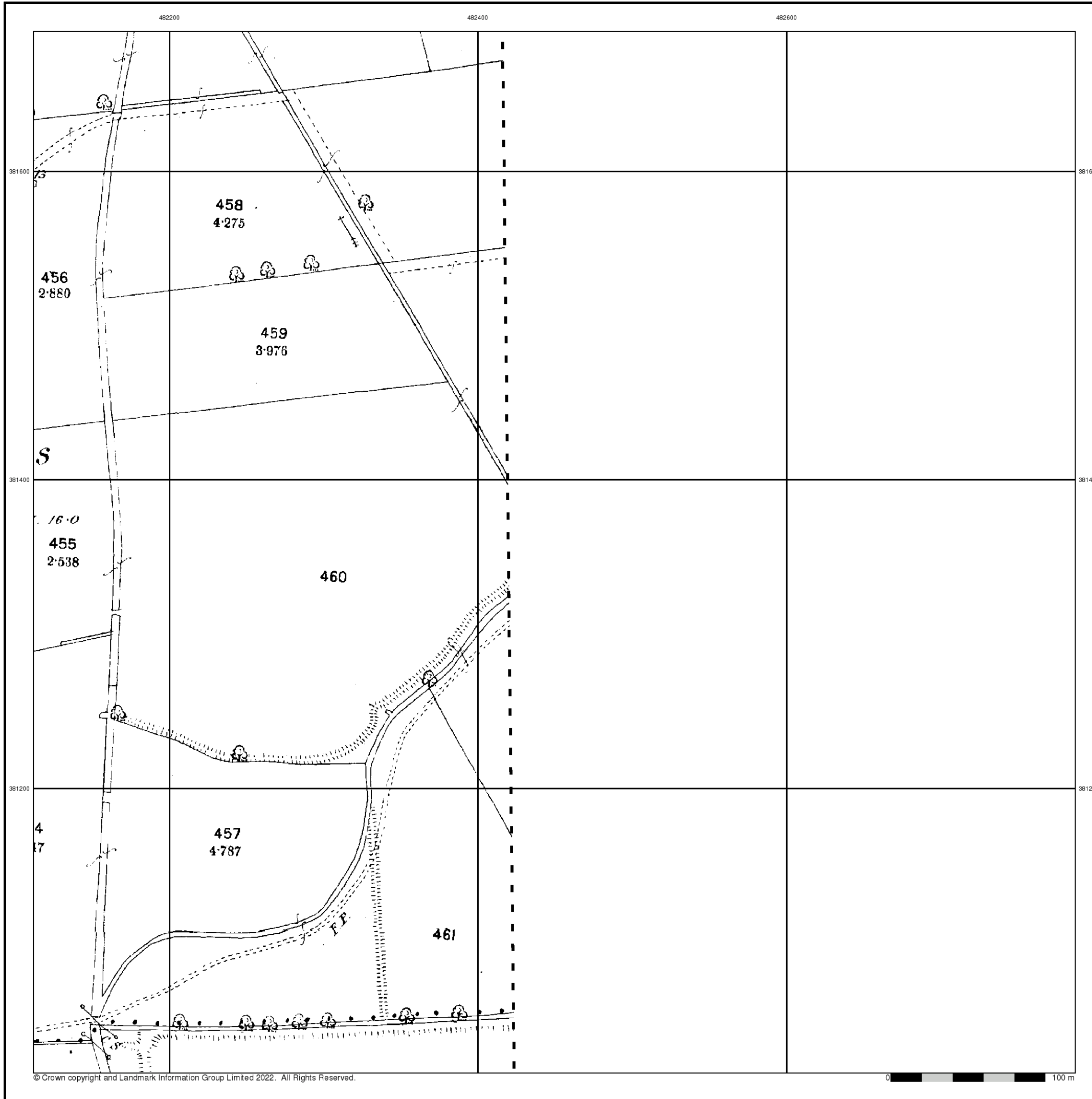

Nottinghamshire

Published 1899

Source map scale - 1:2,500

The historical maps shown were reproduced from maps predominantly held at the scale adopted for England, Wales and Scotland in the 1840's. In 1854 the 1:2,500 scale was adopted for mapping urban areas and by 1896 it covered the whole of what were considered to be the cultivated parts of Great Britain. The published date given below is often some years later than the surveyed date. Before 1938, all OS maps were based on the Cassini Projection, with independent surveys of a single county or group of counties, giving rise to significant inaccuracies in outlying areas.

Map Name(s) and Date(s)

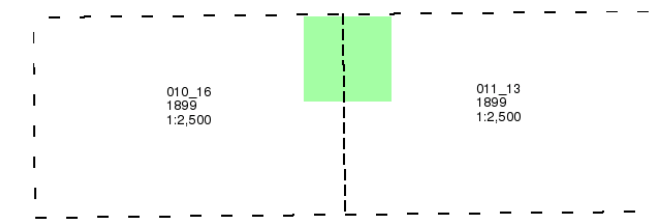

Historical Map - Segment B10

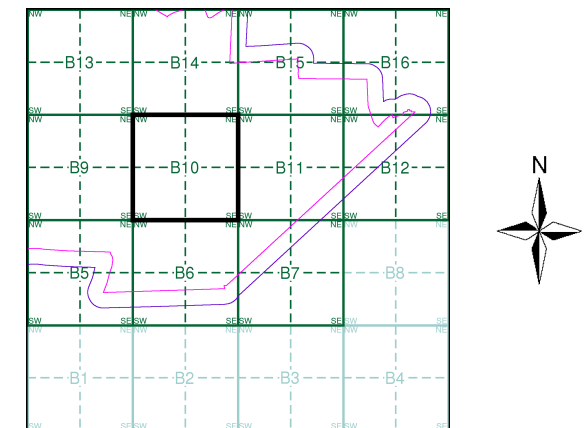

Order Details

Order Number: 298001706_1_1
 Customer Ref: 21-2098.04
 National Grid Reference: 482570, 381420
 Slice: B
 Site Area (Ha): 1355.61
 Search Buffer (m): 100

Site Details

West Barton 2

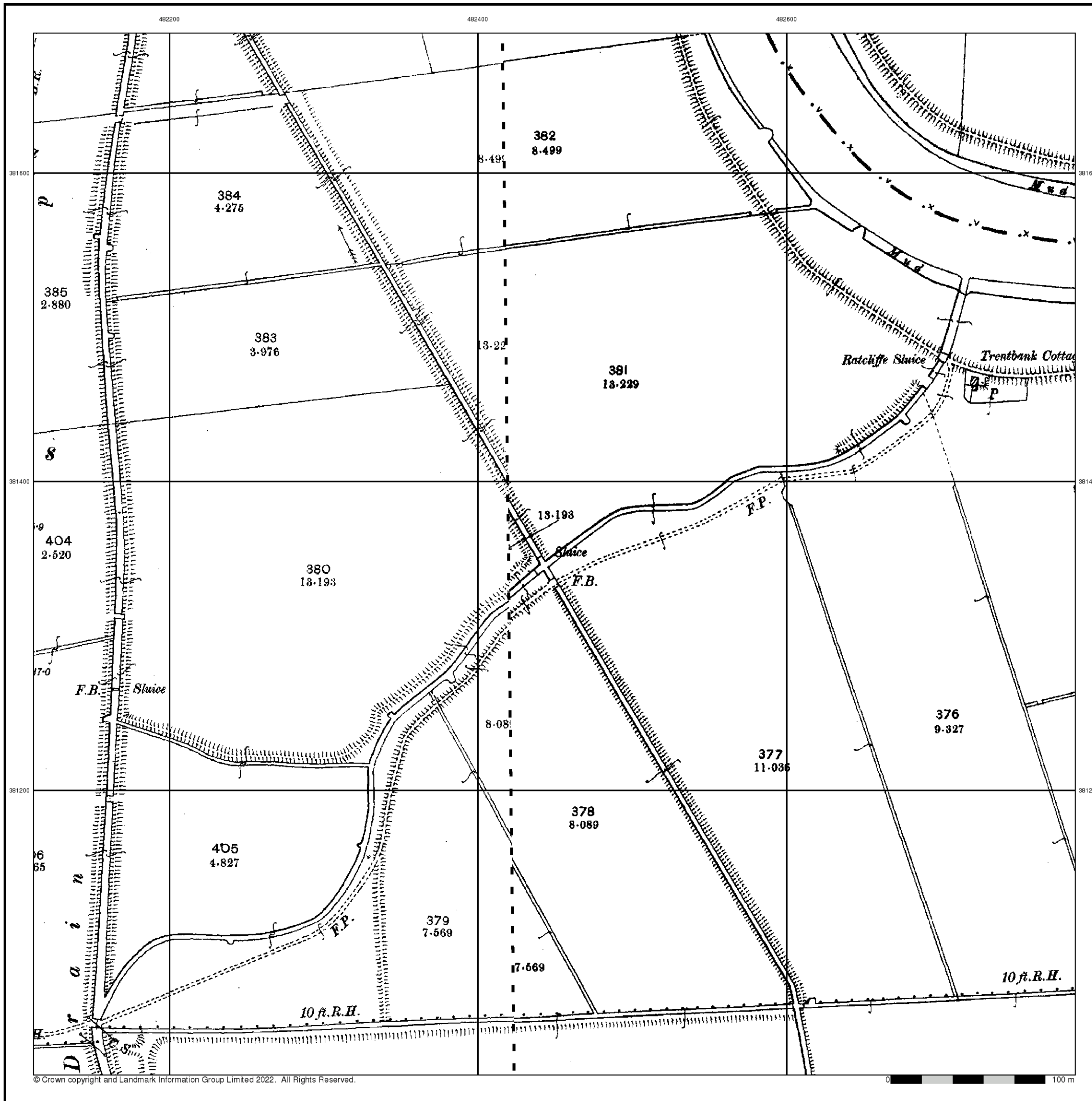

Lincolnshire

Published 1920

Source map scale - 1:2,500

The historical maps shown were reproduced from maps predominantly held at the scale adopted for England, Wales and Scotland in the 1840's. In 1854 the 1:2,500 scale was adopted for mapping urban areas and by 1896 it covered the whole of what were considered to be the cultivated parts of Great Britain. The published date given below is often some years later than the surveyed date. Before 1938, all OS maps were based on the Cassini Projection, with independent surveys of a single county or group of counties, giving rise to significant inaccuracies in outlying areas.

Map Name(s) and Date(s)

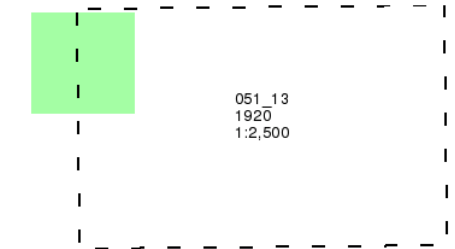

Historical Map - Segment B10

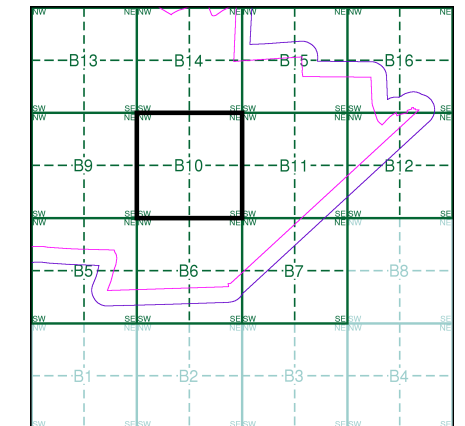

Order Details

Order Number: 298001706_1_1
 Customer Ref: 21-2098.04
 National Grid Reference: 482570, 381420
 Slice: B
 Site Area (Ha): 1355.61
 Search Buffer (m): 100

Site Details

West Barton 2

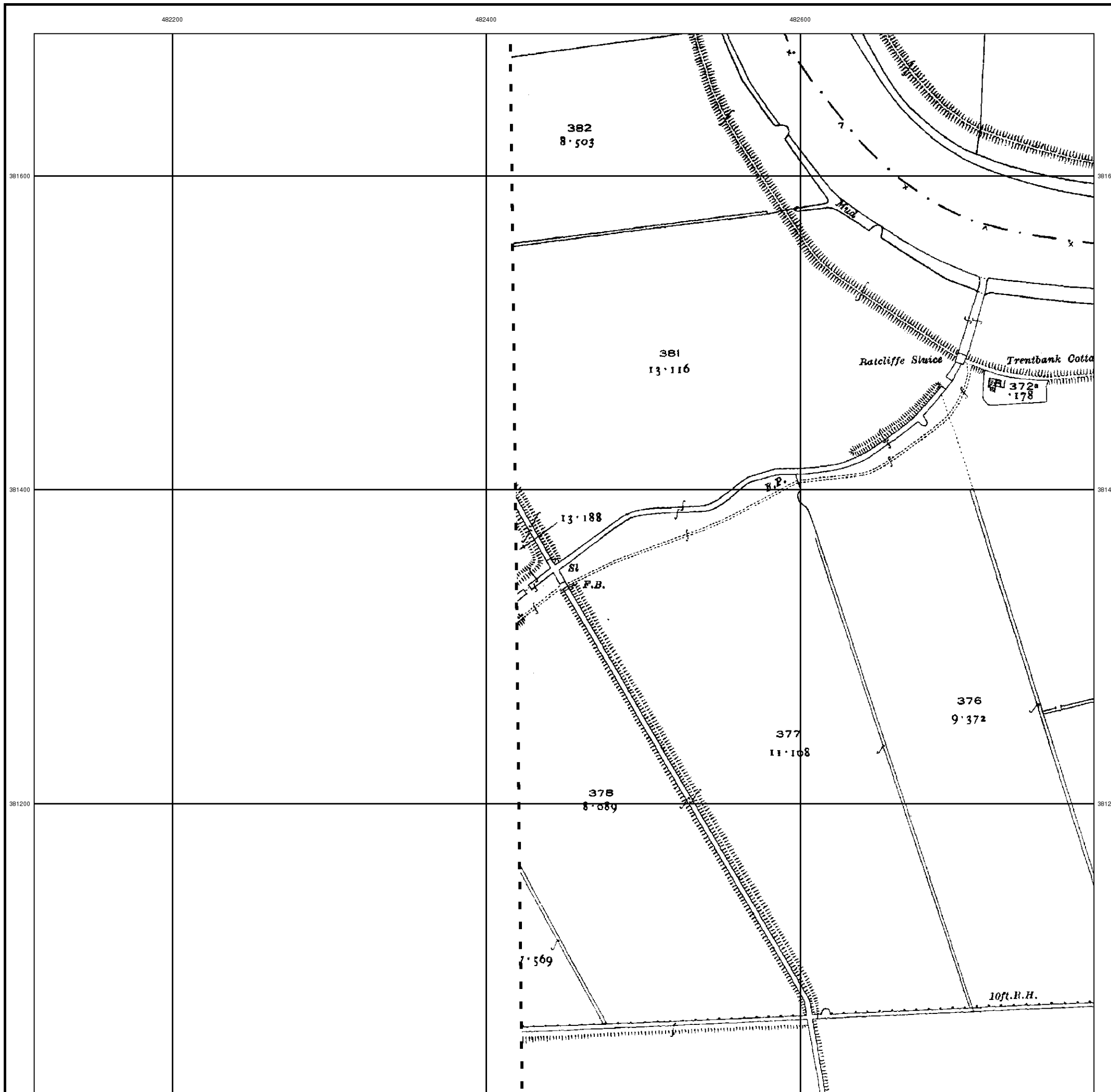

Nottinghamshire

Published 1920

Source map scale - 1:2,500

The historical maps shown were reproduced from maps predominantly held at the scale adopted for England, Wales and Scotland in the 1840's. In 1854 the 1:2,500 scale was adopted for mapping urban areas and by 1896 it covered the whole of what were considered to be the cultivated parts of Great Britain. The published date given below is often some years later than the surveyed date. Before 1938, all OS maps were based on the Cassini Projection, with independent surveys of a single county or group of counties, giving rise to significant inaccuracies in outlying areas.

Map Name(s) and Date(s)

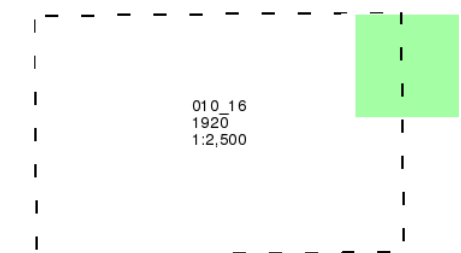

Historical Map - Segment B10

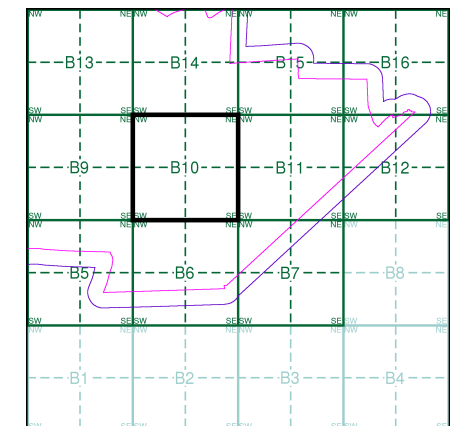

Order Details

Order Number: 298001706_1_1
 Customer Ref: 21-2098.04
 National Grid Reference: 482570, 381420
 Slice: B
 Site Area (Ha): 1355.61
 Search Buffer (m): 100

Site Details

West Barton 2

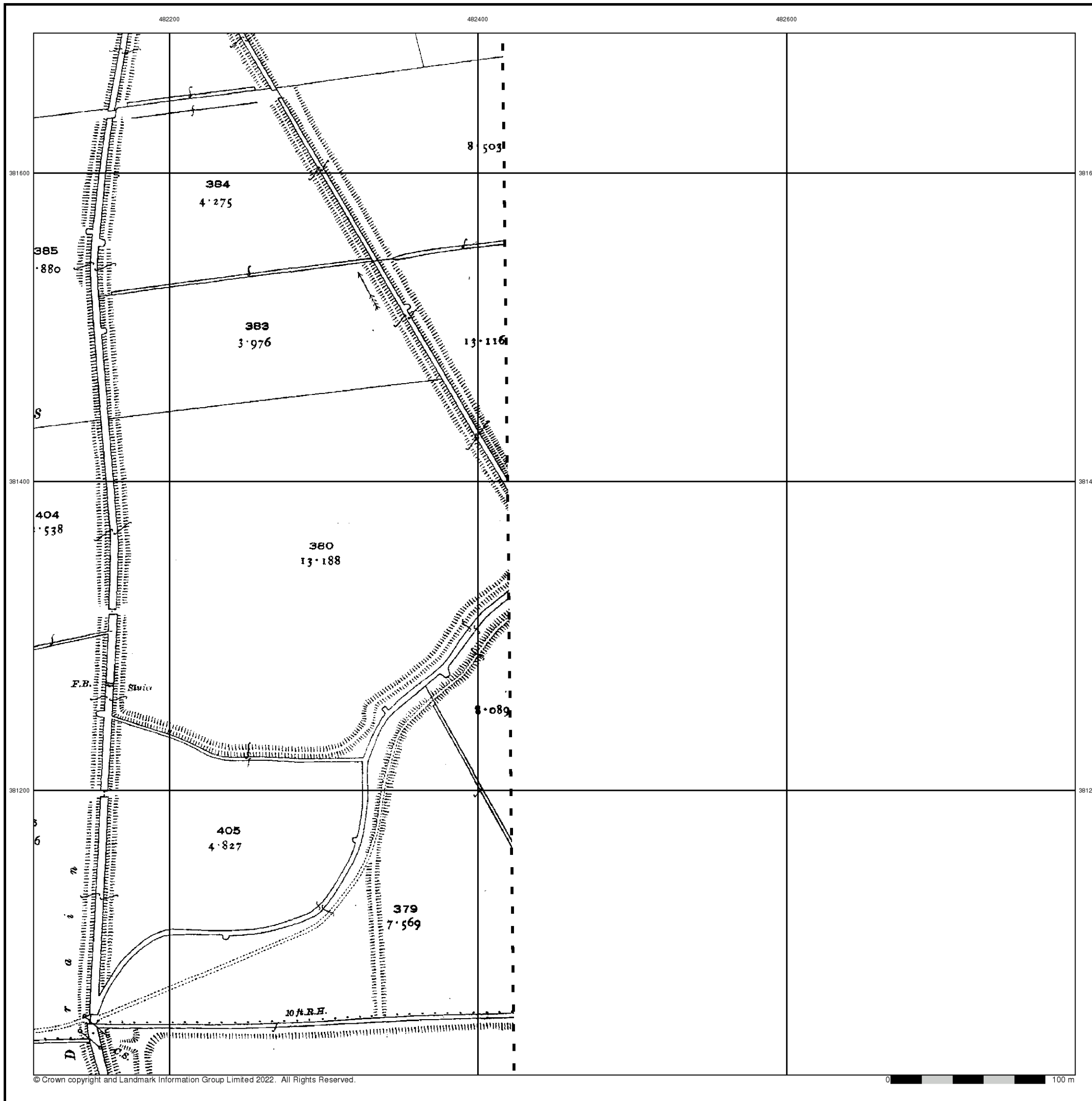

Ordnance Survey Plan

Published 1975

Source map scale - 1:2,500

The historical maps shown were reproduced from maps predominantly held at the scale adopted for England, Wales and Scotland in the 1840's. In 1854 the 1:2,500 scale was adopted for mapping urban areas and by 1896 it covered the whole of what were considered to be the cultivated parts of Great Britain. The published date given below is often some years later than the surveyed date. Before 1938, all OS maps were based on the Cassini Projection, with independent surveys of a single county or group of counties, giving rise to significant inaccuracies in outlying areas.

Map Name(s) and Date(s)

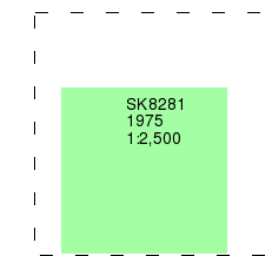

Historical Map - Segment B10

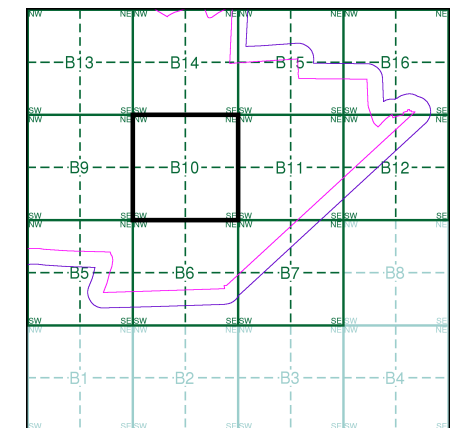

Order Details

Order Number: 298001706_1_1
 Customer Ref: 21-2098.04
 National Grid Reference: 482570, 381420
 Slice: B
 Site Area (Ha): 1355.61
 Search Buffer (m): 100

Site Details

West Barton 2

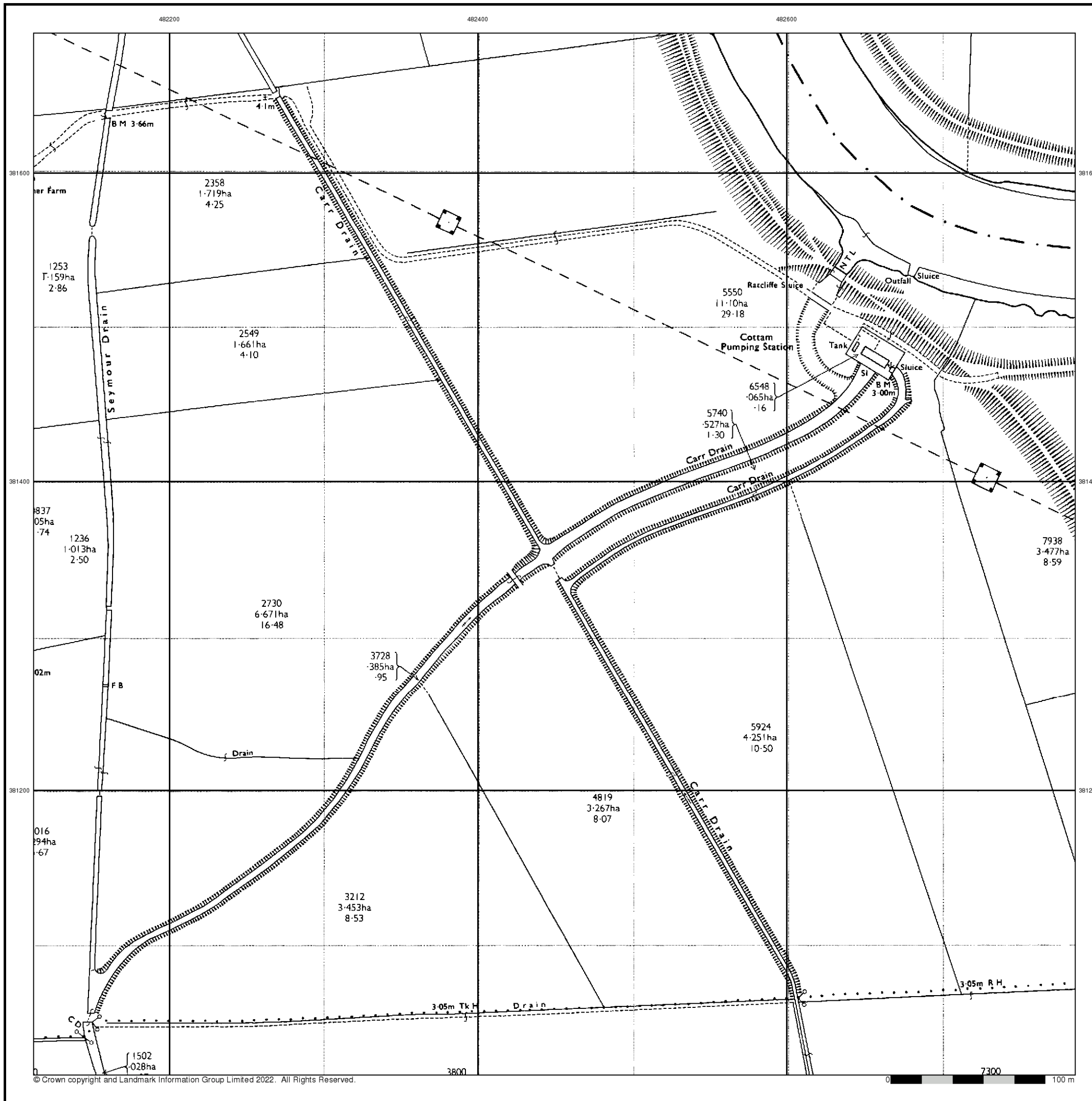

Large-Scale National Grid Data

Published 1994

Source map scale - 1:2,500

'Large Scale National Grid Data' superseded SIM cards (Ordnance Survey's 'Survey of Information on Microfilm') in 1992, and continued to be produced until 1999. These maps were the fore-runners of digital mapping and so provide detailed information on houses and roads, but tend to show less topographic features such as vegetation. These maps were produced at both 1:2,500 and 1:1,250 scales.

Map Name(s) and Date(s)

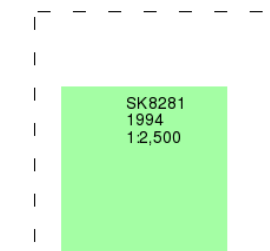

Historical Map - Segment B10

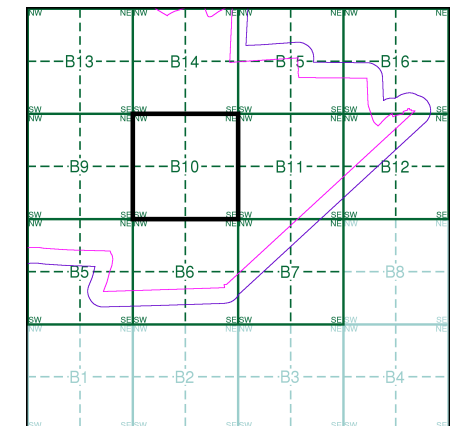

Order Details

Order Number: 298001706_1_1
 Customer Ref: 21-2098.04
 National Grid Reference: 482570, 381420
 Slice: B
 Site Area (Ha): 1355.61
 Search Buffer (m): 100

Site Details

West Barton 2



Historical Mapping Legends

Ordnance Survey County Series and Ordnance Survey Plan 1:2,500

Quarry **Gravel Pit** **Sand Pit**
Clay Pit **Shingle** **Refuse Heap**
Sloping Masonry **Flat Rock**
Marsh **Reeds** **Osiers**
Rough Pasture **Furze** **Wood**
Mixed Wood **Brushwood** **Orchard**
Fir **Ford** **Stepping Stones**
Ferry **Waterfall** **Lock**
Trig. Station **Altitude at Trig. Station**
B.M. 325.9 **Bench Mark** **Surface Level**
Arrow denotes flow of water **Antiquities (site of)**
Cutting **Embankment**
Railway crossing Road **Level Crossing** **Road crossing Railway**
Railway crossing River or Canal **Road over single stream** **Road over River or Canal**
County Boundary (Geographical)
County & Civil Parish Boundary
Administrative County & Civil Parish Boundary
County Borough Boundary (England)
Co. Boro. Bdy.
County Burgh Boundary (Scotland)
Boundary Post or Stone **Police Call Box**
B.R. **Bridle Road** **P** **Pump**
E.P **Electricity Pylon** **S.P** **Signal Post**
F.B. **Foot Bridge** **SL** **Sluice**
F.P. **Foot Path** **Sp.** **Spring**
G.P **Guide Post or Board** **T.C.B** **Telephone Call Box**
M.S **Mile Stone** **Tr.** **Trough**
M.P M.R **Mooring Post or Ring** **W** **Well**

Ordnance Survey Plan, Additional SIMs and Supply of Unpublished Survey Information 1:2,500 and 1:1,250

Inactive Quarry, Chalk Pit or Clay Pit **Active Quarry, Chalk Pit or Clay Pit**
Rock **Boulders**
Cliff **Slopes** **Top**
Roofed Building **Glazed Roof Building**
Sloping Masonry **Archway**
Non-Coniferous Tree (surveyed) **Coniferous Tree (surveyed)**
Non-Coniferous Trees (not surveyed) **Coniferous Trees (not surveyed)**
Orchard Tree **Scrub** **Bracken**
Coppice, Osier **Reeds** **Marsh, Saltings**
Rough Grassland **Heath** **Culvert**
Direction of water flow **Bench Mark** **Antiquity (site of)**
Cave Entrance **Triangulation Station** **Electricity Pylon**
Electricity Transmission Line
County Boundary (Geographical)
County & Civil Parish Boundary
Civil Parish Boundary
Admin. County or County Bor. Boundary
London Borough Boundary
Symbol marking point where boundary mereing changes
BH **Beer House** **P** **Pillar, Pole or Post**
BP, BS **Boundary Post or Stone** **PO** **Post Office**
Cn, C **Capstan, Crane** **PC** **Public Convenience**
Chy **Chimney** **PH** **Public House**
D Fn **Drinking Fountain** **Pp** **Pump**
EI P **Electricity Pillar or Post** **SB, S Br** **Signal Box or Bridge**
FAP **Fire Alarm Pillar** **SP, SL** **Signal Post or Light**
FB **Foot Bridge** **Spr** **Spring**
GP **Guide Post** **Tk** **Tank or Track**
H **Hydrant or Hydraulic** **TCB** **Telephone Call Box**
LC **Level Crossing** **TCP** **Telephone Call Post**
MH **Manhole** **Tr** **Trough**
MP **Mile Post or Mooring Post** **Wr Pt, Wr T** **Water Point, Water Tap**
MS **Mile Stone** **W** **Well**
NTL **Normal Tidal Limit** **Wd Pp** **Wind Pump**

Large-Scale National Grid Data 1:2,500 and 1:1,250

Cliff **Slopes** **Top**
Rock **Rock (scattered)**
Boulders **Boulders (scattered)**
Positioned Boulder **Scree**
Non-Coniferous Tree (surveyed) **Coniferous Tree (surveyed)**
Non-Coniferous Trees (not surveyed) **Coniferous Trees (not surveyed)**
Orchard Tree **Scrub** **Bracken**
Coppice, Osier **Reeds** **Marsh, Saltings**
Rough Grassland **Heath** **Culvert**
Direction of water flow **Triangulation Station** **Antiquity (site of)**
Electricity Transmission Line **Electricity Pylon**
B.M. 231.60m **Bench Mark** **Buildings with Building Seed**
Roofed Building **Glazed Roof Building**
Civil parish/community boundary
District boundary
County boundary
Boundary post/stone
Boundary mereing symbol (note: these always appear in opposed pairs or groups of three)
Bks **Barracks** **P** **Pillar, Pole or Post**
Bty **Battery** **PO** **Post Office**
Cemy **Cemetery** **PC** **Public Convenience**
Chy **Chimney** **Pp** **Pump**
Cis **Cistern** **Ppg Sta** **Pumping Station**
Dismtd Rly **Dismantled Railway** **PW** **Place of Worship**
EI Gen Sta **Electricity Generating Station** **Sewage Ppg Sta** **Sewage Pumping Station**
EI P **Electricity Pole, Pillar** **SB, S Br** **Signal Box or Bridge**
EI Sub Sta **Electricity Sub Station** **SP, SL** **Signal Post or Light**
FB **Filter Bed** **Spr** **Spring**
Fn / D Fn **Fountain / Drinking Ftn.** **Tk** **Tank or Track**
Gas Gov **Gas Valve Compound** **Tr** **Trough**
GVC **Gas Governor** **Wd Pp** **Wind Pump**
GP **Guide Post** **Wr Pt, Wr T** **Water Point, Water Tap**
MH **Manhole** **Wks** **Works (building or area)**
MP, MS **Mile Post or Mile Stone** **W** **Well**



Historical Mapping & Photography included:

Mapping Type	Scale	Date	Pg
Lincolnshire	1:2,500	1886	2
Nottinghamshire	1:2,500	1899	3
Lincolnshire	1:2,500	1920	4
Ordnance Survey Plan	1:2,500	1975	5
Large-Scale National Grid Data	1:2,500	1994	6

Historical Map - Segment B11

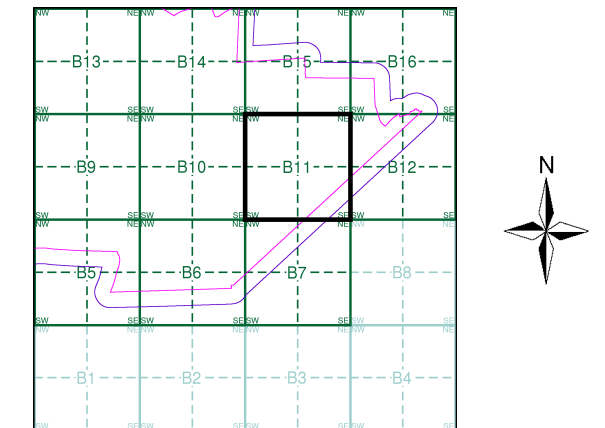

Order Details

Order Number: 298001706_1_1
 Customer Ref: 21-2098.04
 National Grid Reference: 482570, 381420
 Slice: B
 Site Area (Ha): 1355.61
 Search Buffer (m): 100

Site Details

West Barton 2



Tel: 0844 844 9952
 Fax: 0844 844 9951
 Web: [REDACTED]

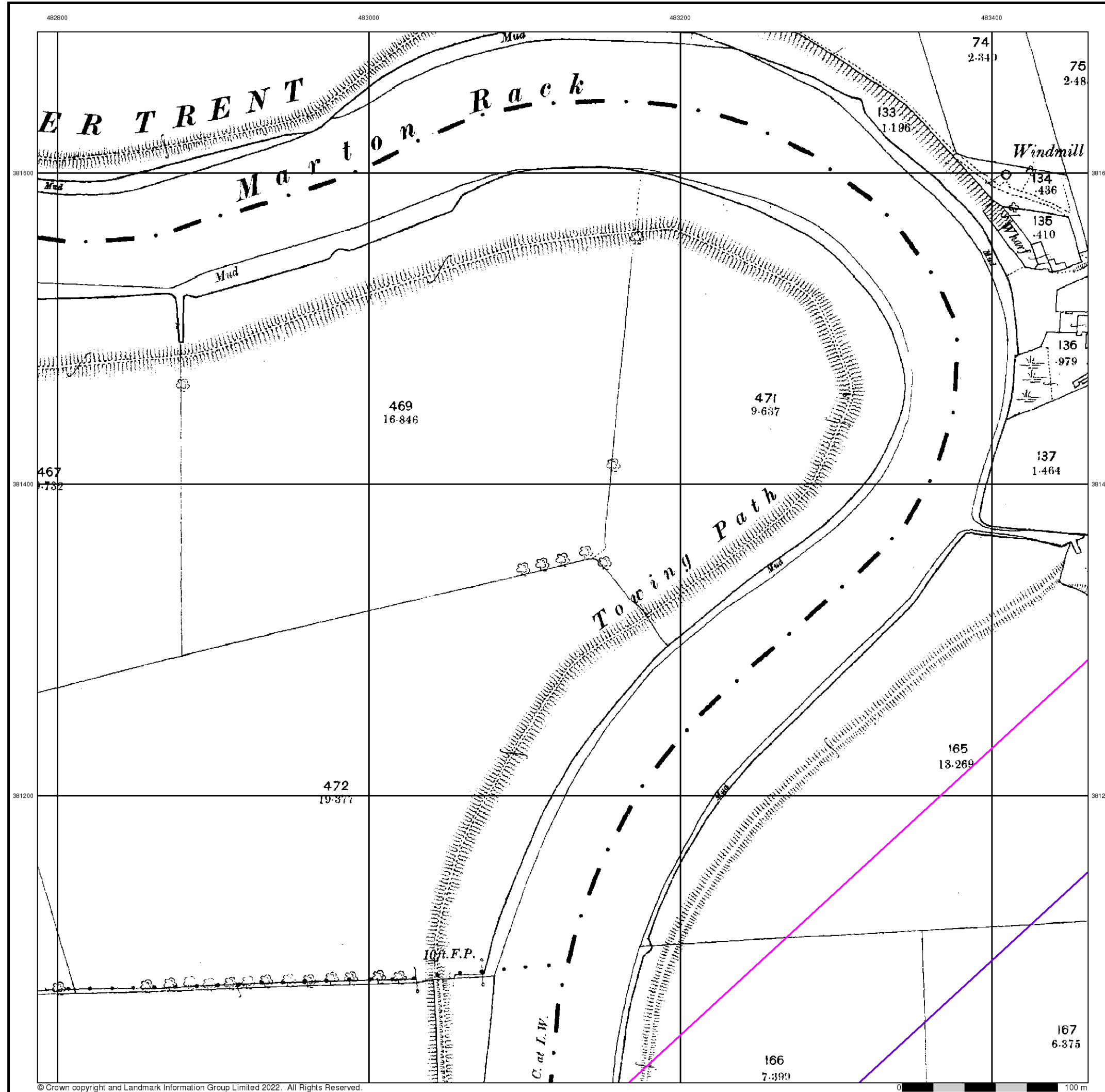

© Crown copyright and Landmark Information Group Limited 2022. All Rights Reserved.



Lincolnshire

Published 1886

Source map scale - 1:2,500

The historical maps shown were reproduced from maps predominantly held at the scale adopted for England, Wales and Scotland in the 1840's. In 1854 the 1:2,500 scale was adopted for mapping urban areas and by 1896 it covered the whole of what were considered to be the cultivated parts of Great Britain. The published date given below is often some years later than the surveyed date. Before 1938, all OS maps were based on the Cassini Projection, with independent surveys of a single county or group of counties, giving rise to significant inaccuracies in outlying areas.

Map Name(s) and Date(s)

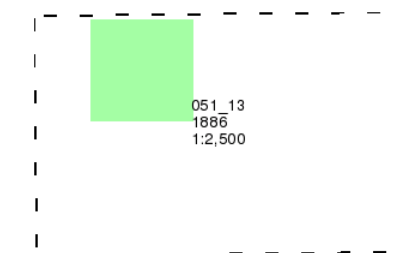

Historical Map - Segment B11

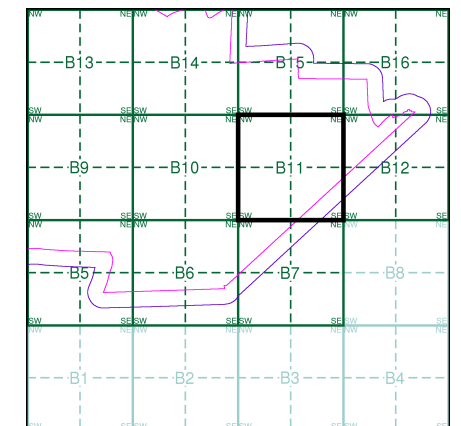

Order Details

Order Number: 298001706_1_1
 Customer Ref: 21-2098.04
 National Grid Reference: 482570, 381420
 Slice: B
 Site Area (Ha): 1355.61
 Search Buffer (m): 100

Site Details

West Barton 2



Tel: 0844 844 9952
 Fax: 0844 844 9951
 Web: [REDACTED]

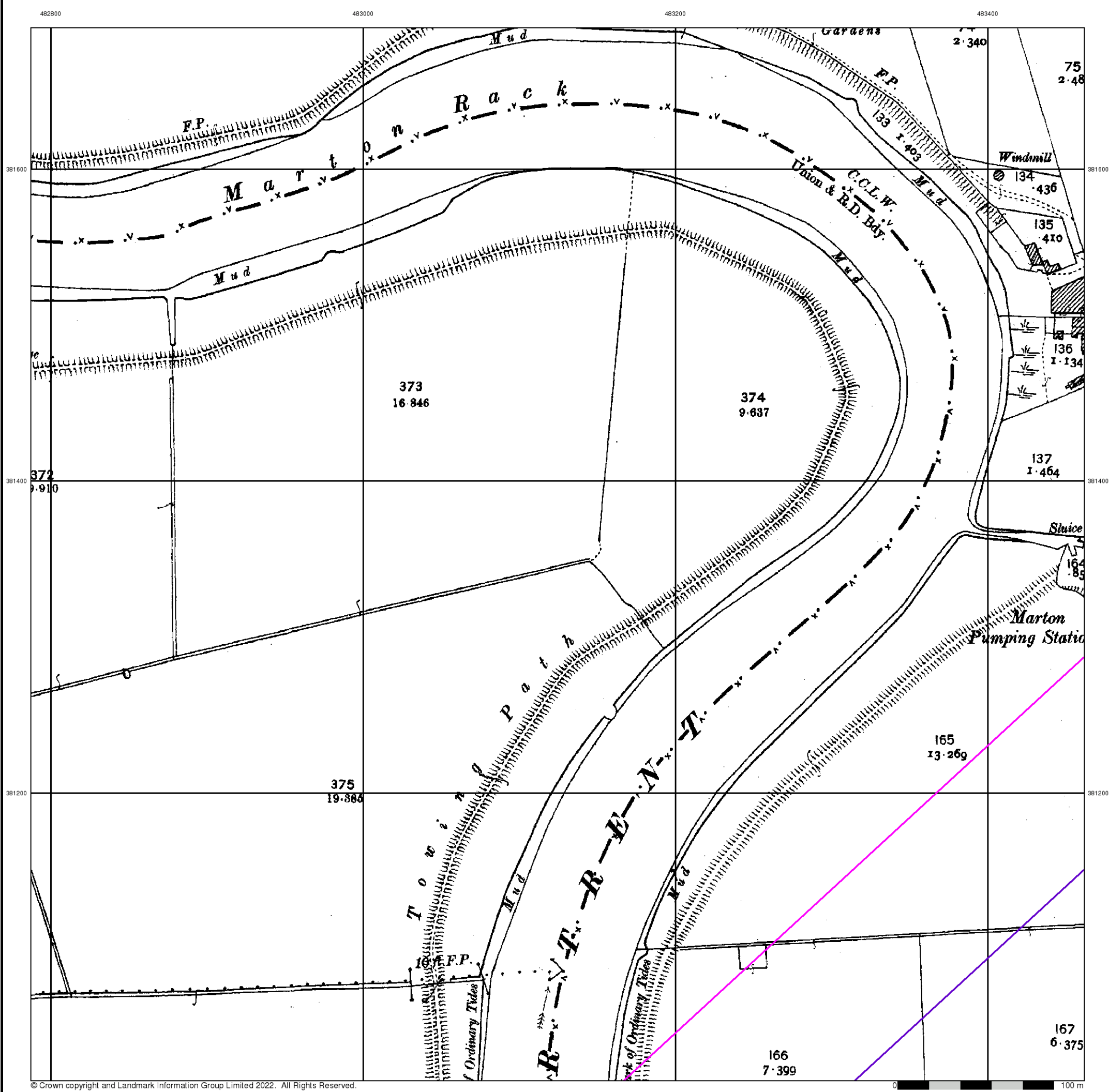

Nottinghamshire
Published 1899
Source map scale - 1:2,500

The historical maps shown were reproduced from maps predominantly held at the scale adopted for England, Wales and Scotland in the 1840's. In 1854 the 1:2,500 scale was adopted for mapping urban areas and by 1896 it covered the whole of what were considered to be the cultivated parts of Great Britain. The published date given below is often some years later than the surveyed date. Before 1938, all OS maps were based on the Cassini Projection, with independent surveys of a single county or group of counties, giving rise to significant inaccuracies in outlying areas.

Map Name(s) and Date(s)

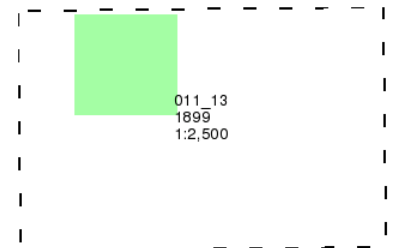

Historical Map - Segment B11

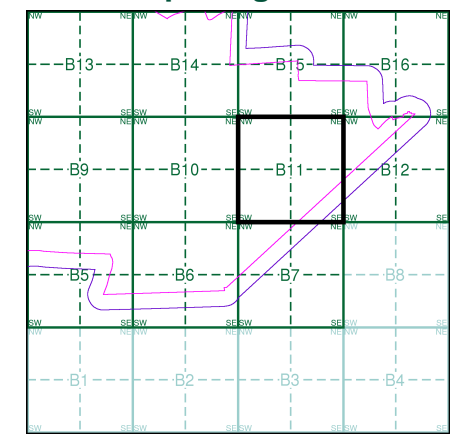

Order Details

Order Number: 298001706_1_1
 Customer Ref: 21-2098.04
 National Grid Reference: 482570, 381420
 Slice: B
 Site Area (Ha): 1355.61
 Search Buffer (m): 100

Site Details

West Barton 2



Tel: 0844 844 9952
 Fax: 0844 844 9951
 Web: [REDACTED]

Lincolnshire

Published 1920

Source map scale - 1:2,500

The historical maps shown were reproduced from maps predominantly held at the scale adopted for England, Wales and Scotland in the 1840's. In 1854 the 1:2,500 scale was adopted for mapping urban areas and by 1896 it covered the whole of what were considered to be the cultivated parts of Great Britain. The published date given below is often some years later than the surveyed date. Before 1938, all OS maps were based on the Cassini Projection, with independent surveys of a single county or group of counties, giving rise to significant inaccuracies in outlying areas.

Map Name(s) and Date(s)

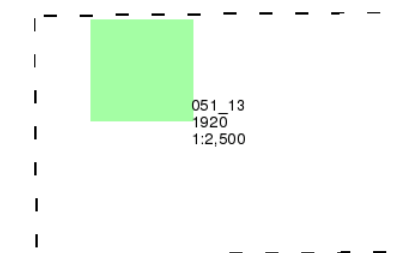

Historical Map - Segment B11

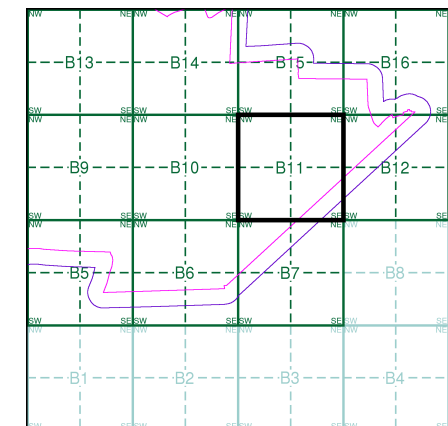

Order Details

Order Number: 298001706_1_1
 Customer Ref: 21-2098.04
 National Grid Reference: 482570, 381420
 Slice: B
 Site Area (Ha): 1355.61
 Search Buffer (m): 100

Site Details

West Barton 2

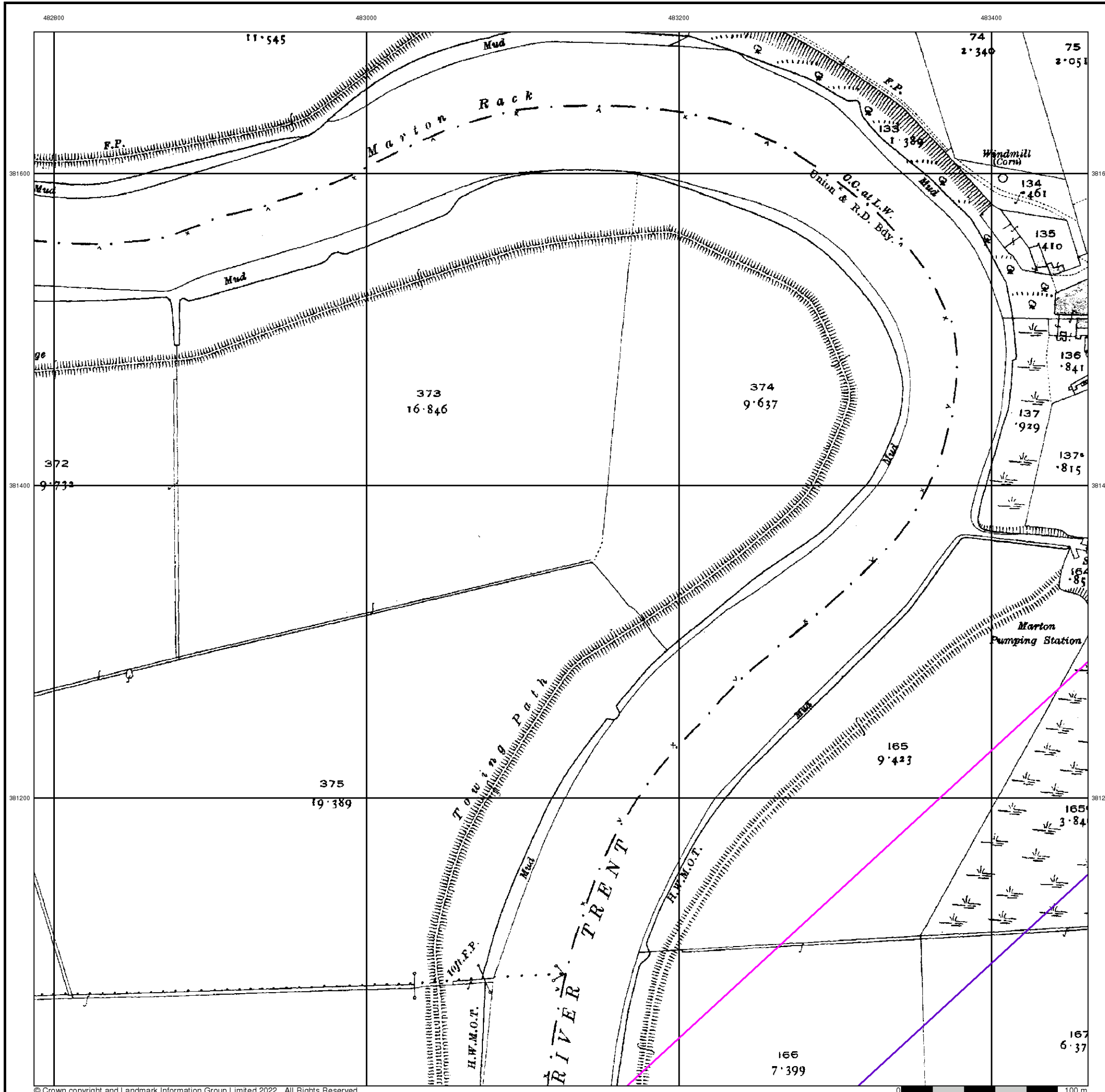

Ordnance Survey Plan

Published 1975

Source map scale - 1:2,500

The historical maps shown were reproduced from maps predominantly held at the scale adopted for England, Wales and Scotland in the 1840's. In 1854 the 1:2,500 scale was adopted for mapping urban areas and by 1896 it covered the whole of what were considered to be the cultivated parts of Great Britain. The published date given below is often some years later than the surveyed date. Before 1938, all OS maps were based on the Cassini Projection, with independent surveys of a single county or group of counties, giving rise to significant inaccuracies in outlying areas.

Map Name(s) and Date(s)

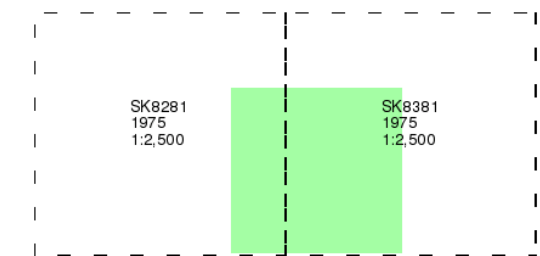

Historical Map - Segment B11

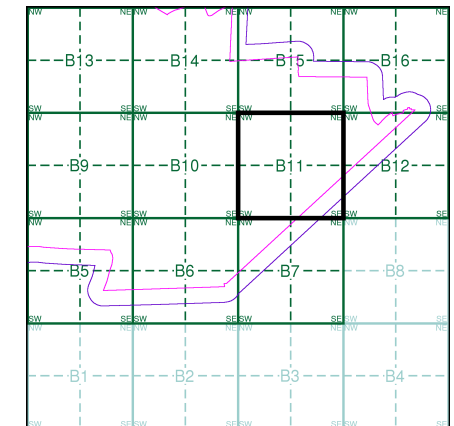

Order Details

Order Number: 298001706_1_1
 Customer Ref: 21-2098.04
 National Grid Reference: 482570, 381420
 Slice: B
 Site Area (Ha): 1355.61
 Search Buffer (m): 100

Site Details

West Barton 2

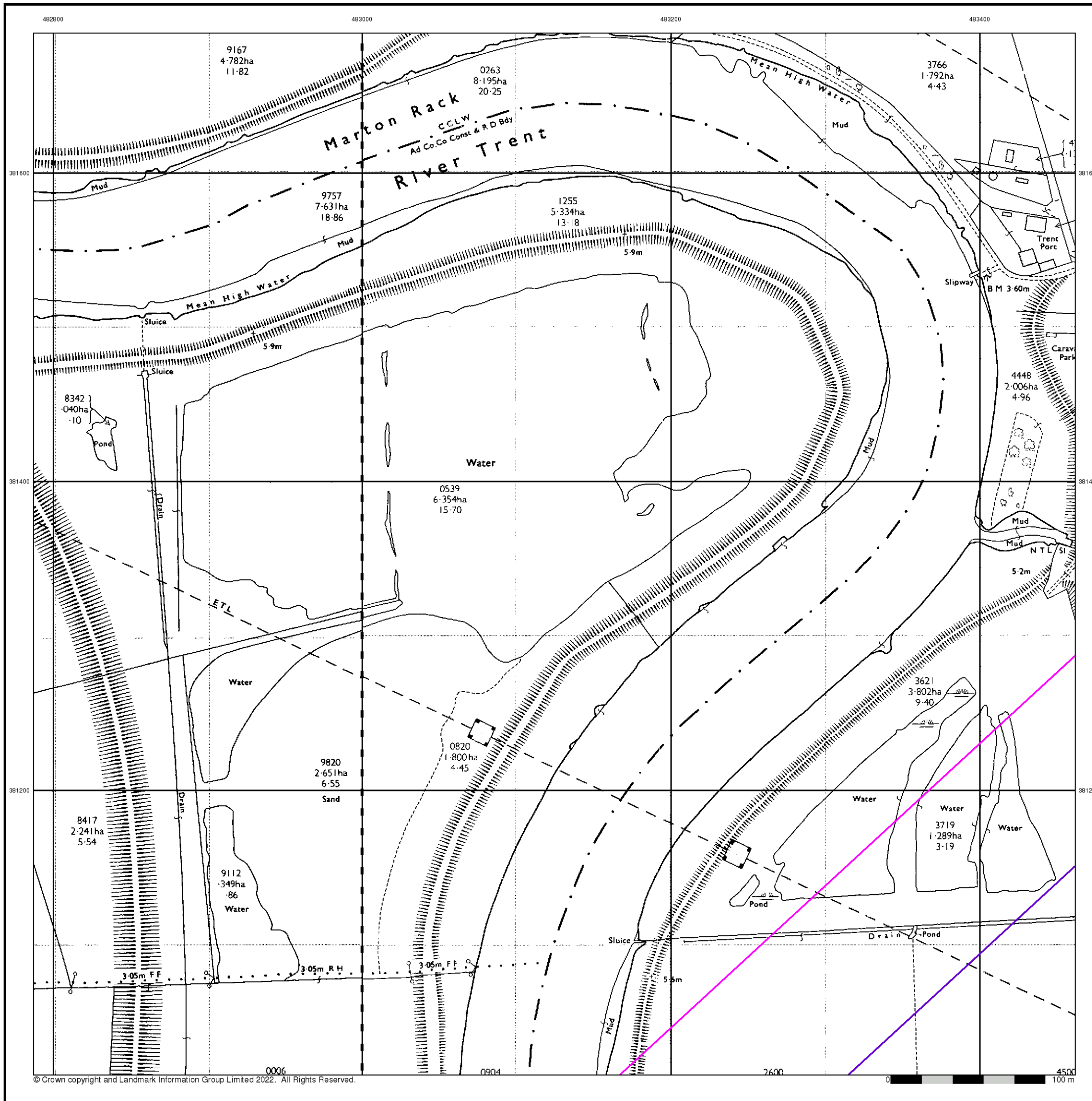

Large-Scale National Grid Data

Published 1994

Source map scale - 1:2,500

'Large Scale National Grid Data' superseded SIM cards (Ordnance Survey's 'Survey of Information on Microfilm') in 1992, and continued to be produced until 1999. These maps were the fore-runners of digital mapping and so provide detailed information on houses and roads, but tend to show less topographic features such as vegetation. These maps were produced at both 1:2,500 and 1:1,250 scales.

Map Name(s) and Date(s)

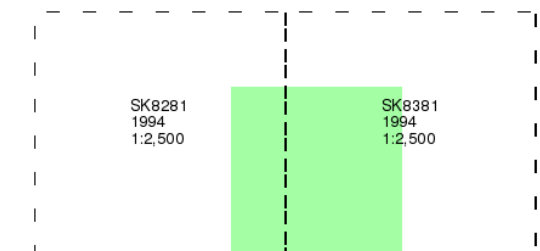

Historical Map - Segment B11

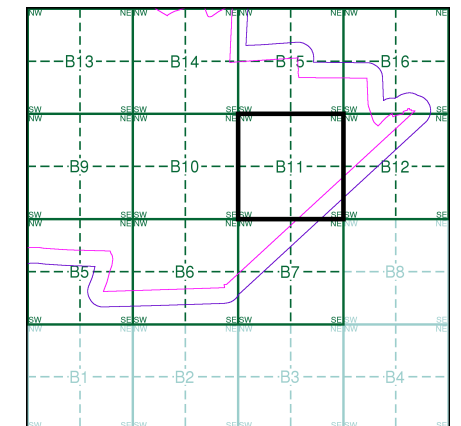

Order Details

Order Number: 298001706_1_1
 Customer Ref: 21-2098.04
 National Grid Reference: 482570, 381420
 Slice: B
 Site Area (Ha): 1355.61
 Search Buffer (m): 100

Site Details

West Barton 2

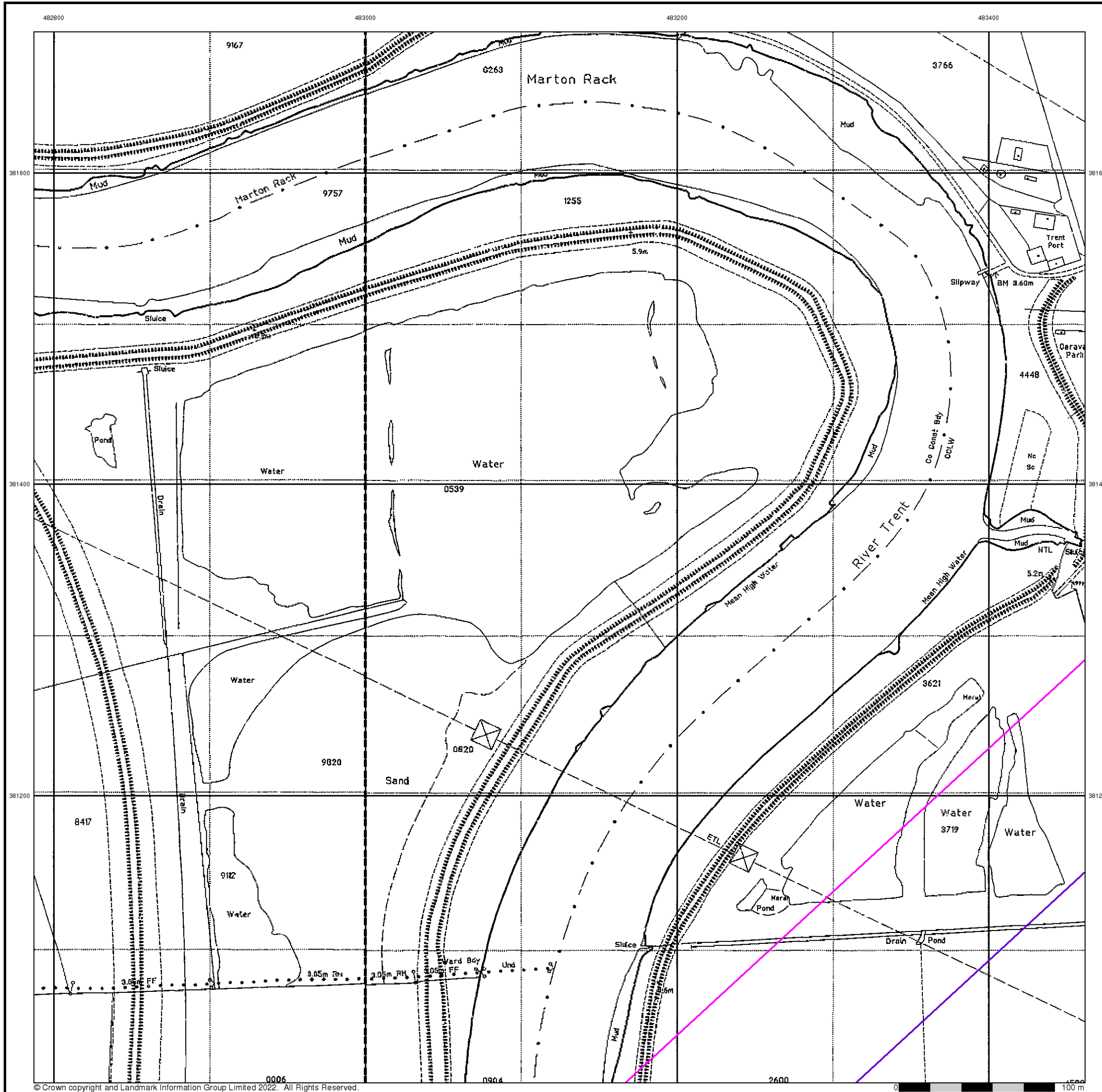

Historical Mapping Legends

Ordnance Survey County Series and Ordnance Survey Plan 1:2,500

Quarry (circular with radial lines), **Gravel Pit** (circular with stippled texture), **Sand Pit** (circular with horizontal lines), **Clay Pit** (circular with vertical lines), **Shingle** (circular with irregular dots), **Refuse Heap** (circular with irregular dots), **Sloping Masonry** (brick pattern), **Flat Rock** (irregular shape with stippled texture).

Marsh (horizontal lines with tufts), **Reeds** (vertical lines with tufts), **Osiers** (vertical lines with tufts), **Rough Pasture** (irregular shape with stippled texture), **Furze** (irregular shape with stippled texture), **Wood** (irregular shape with stippled texture), **Mixed Wood** (irregular shape with stippled texture), **Brushwood** (irregular shape with stippled texture), **Orchard** (irregular shape with stippled texture).

Fir (triangular tree symbol), **Ford** (shallow water symbol), **Stepping Stones** (irregular shape with stippled texture), **Ferry** (irregular shape with stippled texture), **Waterfall** (irregular shape with stippled texture), **Lock** (irregular shape with stippled texture).

Trig. Station (triangle with '507'), **Altitude at Trig. Station** (triangle with '342'), **B.M. 325.9** (upward arrow with '342'), **Surface Level** (upward arrow), **Arrow denotes flow of water** (arrow with wavy lines), **Antiquities (site of)** (circle with cross).

Cutting (irregular shape with stippled texture), **Embankment** (irregular shape with stippled texture).

Railway crossing Road (crossing symbol), **Level Crossing** (crossing symbol), **Road crossing Railway** (crossing symbol).

Railway crossing River or Canal (crossing symbol), **Road over single stream** (crossing symbol), **Road over River or Canal** (crossing symbol).

County Boundary (Geographical) (dashed line), **County & Civil Parish Boundary** (dash-dot line), **Administrative County & Civil Parish Boundary** (dash-dot-dot line), **County Borough Boundary (England)** (dotted line), **Co. Boro. Bdy.** (dotted line), **County Burgh Boundary (Scotland)** (dotted line).

BP BS Boundary Post or Stone, **P.C.B** Police Call Box, **B.R.** Bridle Road, **P** Pump, **E.P** Electricity Pylon, **S.P** Signal Post, **F.B.** Foot Bridge, **SL** Sluice, **F.P.** Foot Path, **Sp.** Spring, **G.P** Guide Post or Board, **T.C.B** Telephone Call Box, **M.S** Mile Stone, **Tr.** Trough, **M.P M.R** Mooring Post or Ring, **W** Well.

Ordnance Survey Plan, Additional SIMs and Supply of Unpublished Survey Information 1:2,500 and 1:1,250

Inactive Quarry, Chalk Pit or Clay Pit (circular with radial lines), **Active Quarry, Chalk Pit or Clay Pit** (circular with radial lines), **Rock** (irregular shape with stippled texture), **Boulders** (irregular shape with stippled texture).

Cliff (irregular shape with stippled texture), **Slopes** (vertical lines), **Top** (vertical lines).

Roofed Building (brick pattern), **Glazed Roof Building** (brick pattern with diagonal lines), **Sloping Masonry** (brick pattern), **Archway** (irregular shape with stippled texture).

Non-Coniferous Tree (surveyed) (circle with cross), **Coniferous Tree (surveyed)** (circle with cross), **Non-Coniferous Trees (not surveyed)** (circle with cross), **Coniferous Trees (not surveyed)** (circle with cross).

Orchard Tree (circle with cross), **Scrub** (circle with cross), **Bracken** (circle with cross), **Coppice, Osier** (circle with cross), **Reeds** (circle with cross), **Marsh, Saltings** (circle with cross).

Rough Grassland (irregular shape with stippled texture), **Heath** (irregular shape with stippled texture), **Culvert** (irregular shape with stippled texture).

Direction of water flow (arrow with wavy lines), **Bench Mark** (upward arrow with 'B.M.'), **Antiquity (site of)** (circle with cross), **Cave Entrance** (circle with cross), **Triangulation Station** (triangle), **Electricity Pylon** (square with cross).

Electricity Transmission Line (line with cross-ticks).

County Boundary (Geographical) (dashed line), **County & Civil Parish Boundary** (dash-dot line), **Civil Parish Boundary** (dotted line), **Admin. County or County Bor. Boundary** (dash-dot-dot line), **London Borough Boundary** (dotted line), **Symbol marking point where boundary mereing changes** (circle with cross).

BH Beer House, **P** Pillar, Pole or Post, **BP, BS** Boundary Post or Stone, **PO** Post Office, **Cn, C** Capstan, Crane, **PC** Public Convenience, **Chy** Chimney, **PH** Public House, **D Fn** Drinking Fountain, **Pp** Pump, **EI P** Electricity Pillar or Post, **SB, S Br** Signal Box or Bridge, **FAP** Fire Alarm Pillar, **SP, SL** Signal Post or Light, **FB** Foot Bridge, **Spr** Spring, **GP** Guide Post, **Tk** Tank or Track, **H** Hydrant or Hydraulic, **TCB** Telephone Call Box, **LC** Level Crossing, **TCP** Telephone Call Post, **MH** Manhole, **Tr** Trough, **MP** Mile Post or Mooring Post, **Wr Pt, Wr T** Water Point, Water Tap, **MS** Mile Stone, **W** Well, **NTL** Normal Tidal Limit, **Wd Pp** Wind Pump.

Large-Scale National Grid Data 1:2,500 and 1:1,250

Cliff (irregular shape with stippled texture), **Slopes** (vertical lines), **Top** (vertical lines).

Rock (irregular shape with stippled texture), **Rock (scattered)** (irregular shape with stippled texture), **Boulders** (irregular shape with stippled texture), **Boulders (scattered)** (irregular shape with stippled texture), **Positioned Boulder** (irregular shape with stippled texture), **Scree** (irregular shape with stippled texture).

Non-Coniferous Tree (surveyed) (circle with cross), **Coniferous Tree (surveyed)** (circle with cross), **Non-Coniferous Trees (not surveyed)** (circle with cross), **Coniferous Trees (not surveyed)** (circle with cross).

Orchard Tree (circle with cross), **Scrub** (circle with cross), **Bracken** (circle with cross), **Coppice, Osier** (circle with cross), **Reeds** (circle with cross), **Marsh, Saltings** (circle with cross).

Rough Grassland (irregular shape with stippled texture), **Heath** (irregular shape with stippled texture), **Culvert** (irregular shape with stippled texture).

Direction of water flow (arrow with wavy lines), **Triangulation Station** (triangle), **Antiquity (site of)** (circle with cross), **Electricity Transmission Line** (line with cross-ticks), **Electricity Pylon** (square with cross), **B.M. 231.60m** Bench Mark, **Buildings with Building Seed** (irregular shape with stippled texture), **Roofed Building** (brick pattern), **Glazed Roof Building** (brick pattern with diagonal lines).

Civil parish/community boundary (dotted line), **District boundary** (dotted line), **County boundary** (dotted line), **Boundary post/stone** (circle with cross), **Boundary mereing symbol (note: these always appear in opposed pairs or groups of three)** (circle with cross).

Bks Barracks, **P** Pillar, Pole or Post, **Bty** Battery, **PO** Post Office, **Cemy** Cemetery, **PC** Public Convenience, **Chy** Chimney, **Pp** Pump, **Cis** Cistern, **Ppg Sta** Pumping Station, **Dismtd Rly** Dismantled Railway, **PW** Place of Worship, **EI Gen Sta** Electricity Generating Station, **Sewage Ppg Sta** Sewage Pumping Station, **EI P** Electricity Pole, Pillar, **SB, S Br** Signal Box or Bridge, **EI Sub Sta** Electricity Sub Station, **SP, SL** Signal Post or Light, **FB** Filter Bed, **Spr** Spring, **Fn / D Fn** Fountain / Drinking Ftn., **Tk** Tank or Track, **Gas Gov** Gas Valve Compound, **Tr** Trough, **GVC** Gas Governor, **Wd Pp** Wind Pump, **GP** Guide Post, **Wr Pt, Wr T** Water Point, Water Tap, **MH** Manhole, **Wks** Works (building or area), **MP, MS** Mile Post or Mile Stone, **W** Well.



Historical Mapping & Photography included:

Mapping Type	Scale	Date	Pg
Lincolnshire	1:2,500	1886	2
Nottinghamshire	1:2,500	1899	3
Lincolnshire	1:2,500	1920	4
Ordnance Survey Plan	1:2,500	1974 - 1975	5
Additional SIMs	1:2,500	1993	6
Large-Scale National Grid Data	1:2,500	1994	7

Historical Map - Segment B12

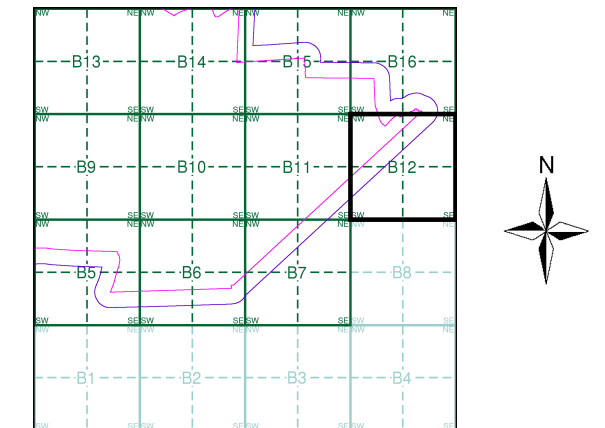

Order Details

Order Number: 298001706_1_1
 Customer Ref: 21-2098.04
 National Grid Reference: 482570, 381420
 Slice: B
 Site Area (Ha): 1355.61
 Search Buffer (m): 100

Site Details

West Barton 2



Tel: 0844 844 9952
 Fax: 0844 844 9951
 Web: [REDACTED]

Lincolnshire

Published 1886

Source map scale - 1:2,500

The historical maps shown were reproduced from maps predominantly held at the scale adopted for England, Wales and Scotland in the 1840's. In 1854 the 1:2,500 scale was adopted for mapping urban areas and by 1896 it covered the whole of what were considered to be the cultivated parts of Great Britain. The published date given below is often some years later than the surveyed date. Before 1938, all OS maps were based on the Cassini Projection, with independent surveys of a single county or group of counties, giving rise to significant inaccuracies in outlying areas.

Map Name(s) and Date(s)

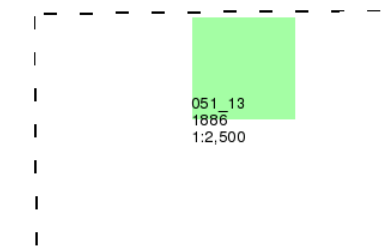

Historical Map - Segment B12

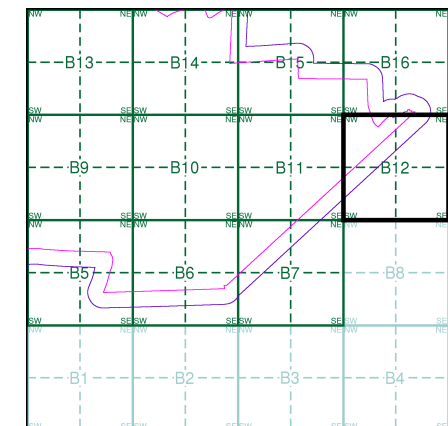

Order Details

Order Number: 298001706_1_1
 Customer Ref: 21-2098.04
 National Grid Reference: 482570, 381420
 Slice: B
 Site Area (Ha): 1355.61
 Search Buffer (m): 100

Site Details

West Barton 2

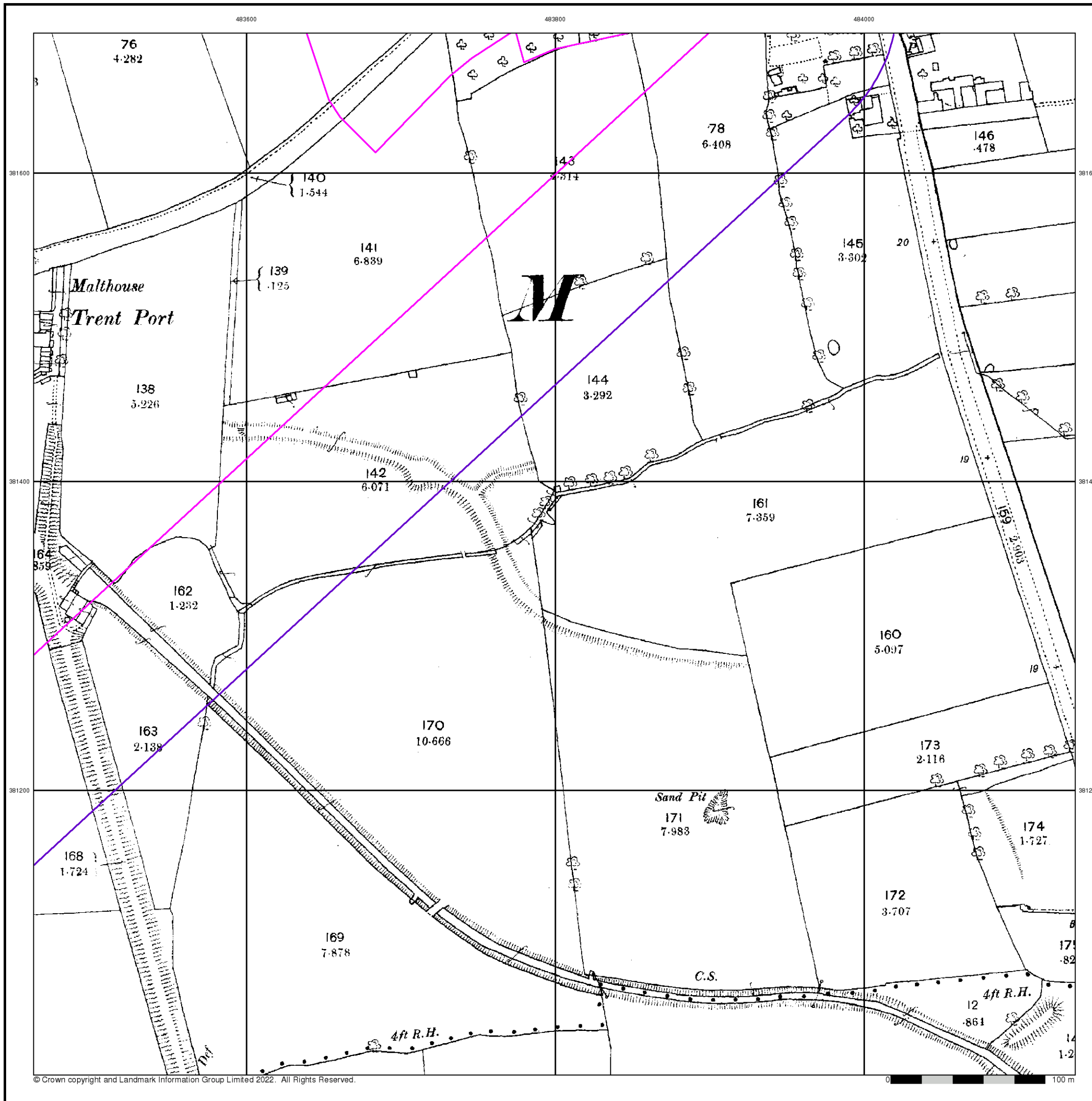

Nottinghamshire

Published 1899

Source map scale - 1:2,500

The historical maps shown were reproduced from maps predominantly held at the scale adopted for England, Wales and Scotland in the 1840's. In 1854 the 1:2,500 scale was adopted for mapping urban areas and by 1896 it covered the whole of what were considered to be the cultivated parts of Great Britain. The published date given below is often some years later than the surveyed date. Before 1938, all OS maps were based on the Cassini Projection, with independent surveys of a single county or group of counties, giving rise to significant inaccuracies in outlying areas.

Map Name(s) and Date(s)

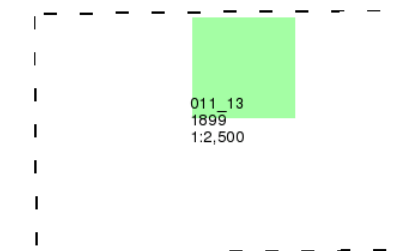

Historical Map - Segment B12

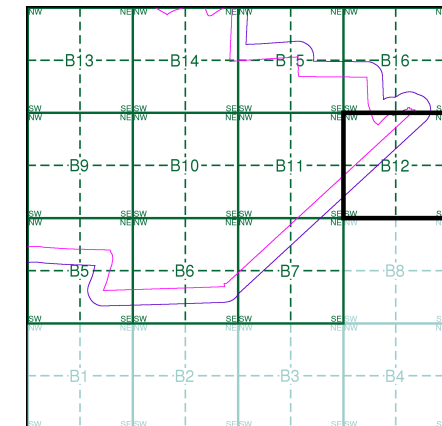

Order Details

Order Number: 298001706_1_1
 Customer Ref: 21-2098.04
 National Grid Reference: 482570, 381420
 Slice: B
 Site Area (Ha): 1355.61
 Search Buffer (m): 100

Site Details

West Barton 2

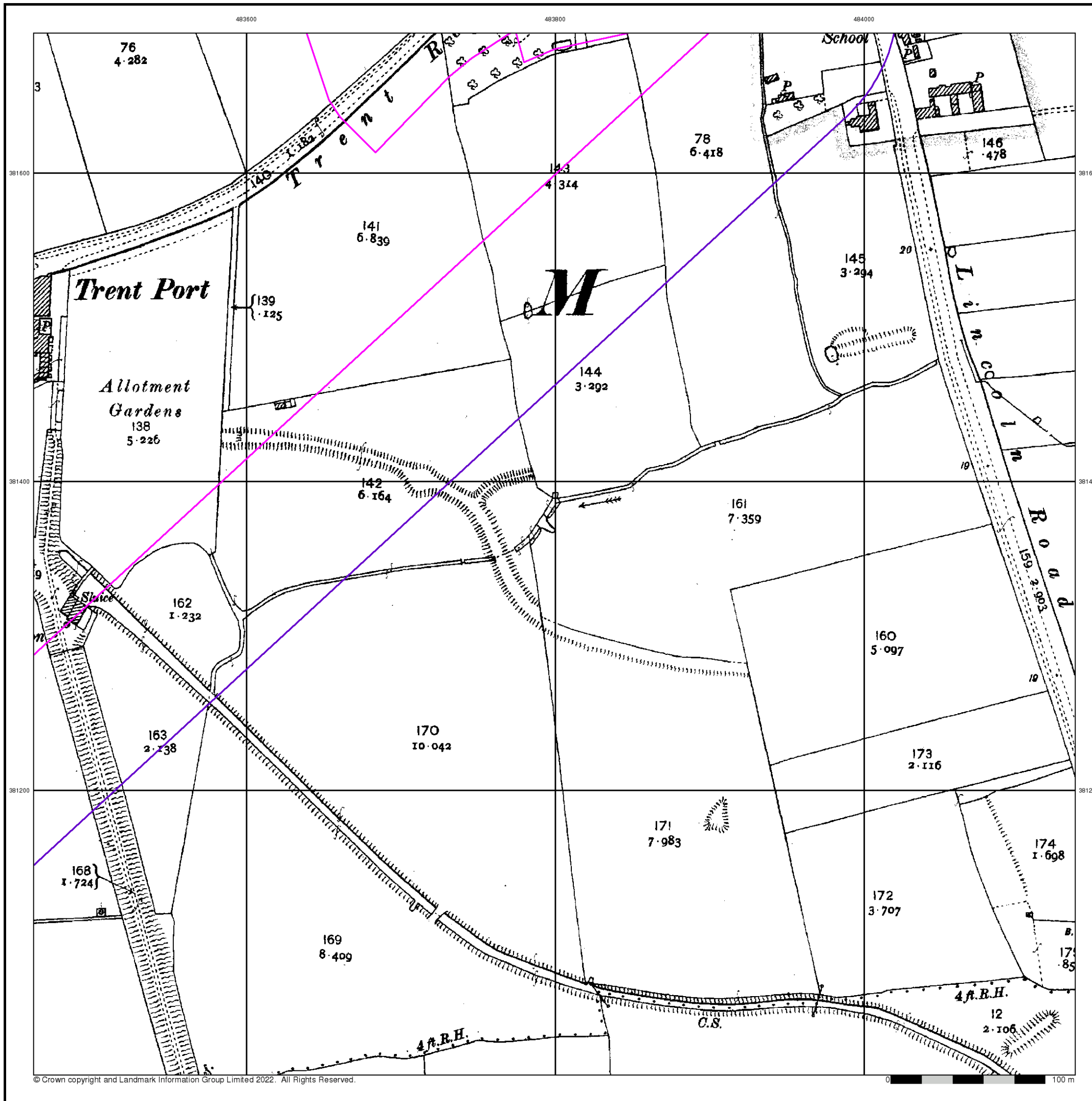

Lincolnshire

Published 1920

Source map scale - 1:2,500

The historical maps shown were reproduced from maps predominantly held at the scale adopted for England, Wales and Scotland in the 1840's. In 1854 the 1:2,500 scale was adopted for mapping urban areas and by 1896 it covered the whole of what were considered to be the cultivated parts of Great Britain. The published date given below is often some years later than the surveyed date. Before 1938, all OS maps were based on the Cassini Projection, with independent surveys of a single county or group of counties, giving rise to significant inaccuracies in outlying areas.

Map Name(s) and Date(s)

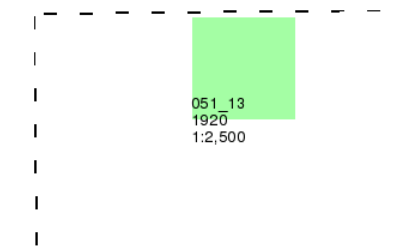

Historical Map - Segment B12

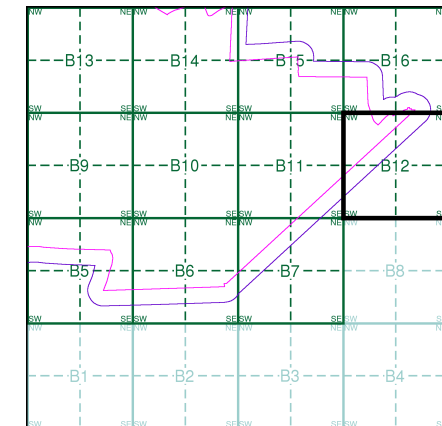

Order Details

Order Number: 298001706_1_1
 Customer Ref: 21-2098.04
 National Grid Reference: 482570, 381420
 Slice: B
 Site Area (Ha): 1355.61
 Search Buffer (m): 100

Site Details

West Barton 2

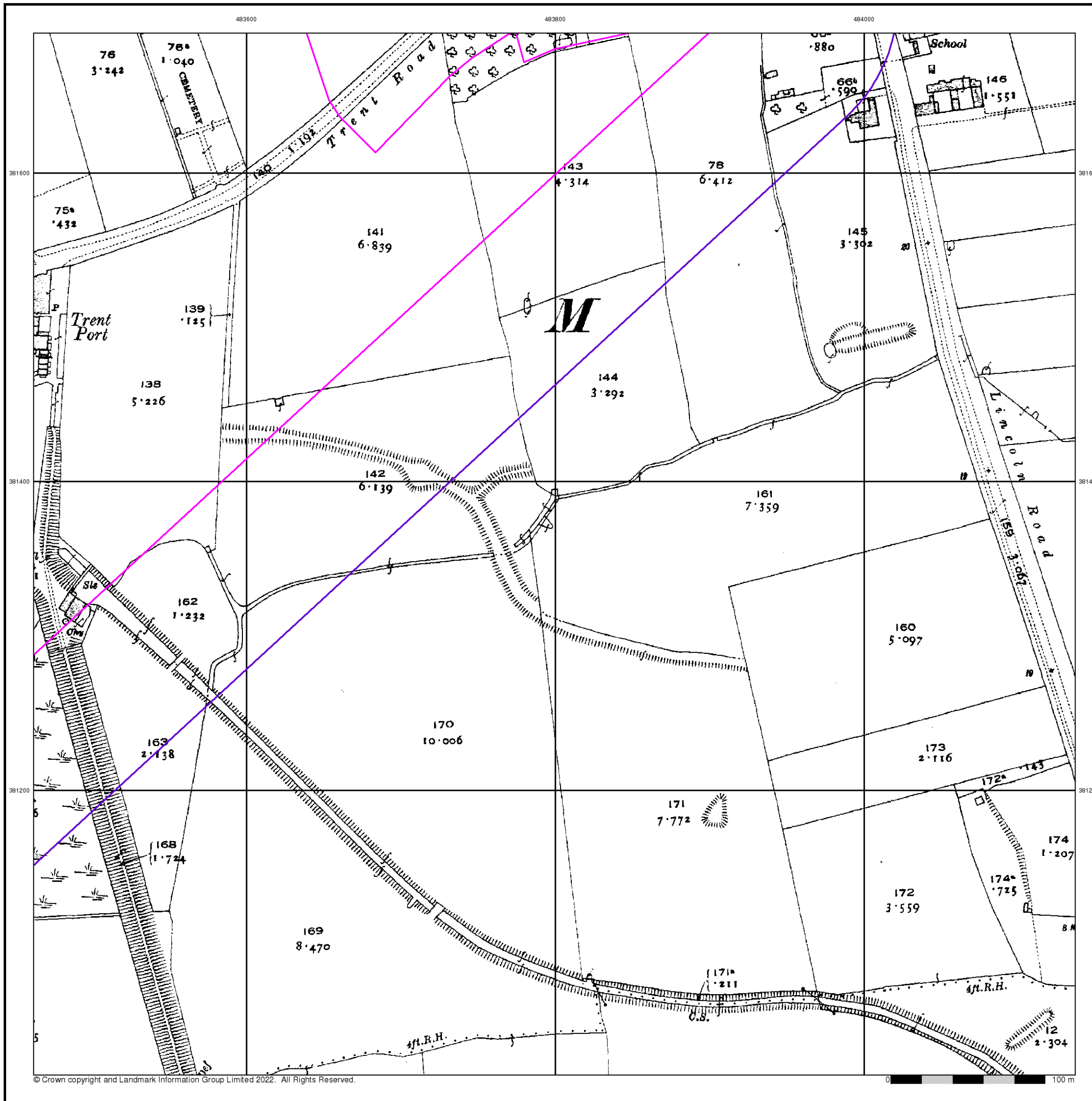

Ordnance Survey Plan

Published 1974 - 1975

Source map scale - 1:2,500

The historical maps shown were reproduced from maps predominantly held at the scale adopted for England, Wales and Scotland in the 1840's. In 1854 the 1:2,500 scale was adopted for mapping urban areas and by 1896 it covered the whole of what were considered to be the cultivated parts of Great Britain. The published date given below is often some years later than the surveyed date. Before 1938, all OS maps were based on the Cassini Projection, with independent surveys of a single county or group of counties, giving rise to significant inaccuracies in outlying areas.

Map Name(s) and Date(s)

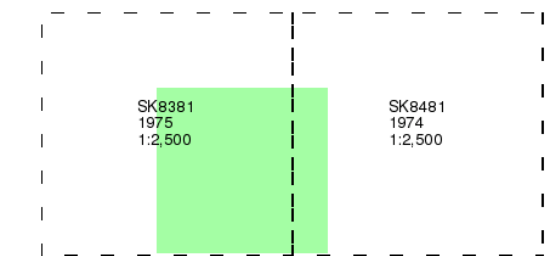

Historical Map - Segment B12

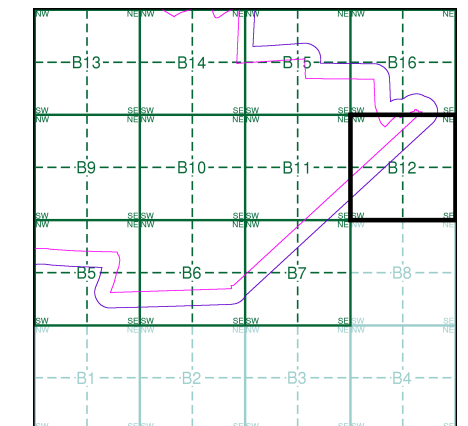

Order Details

Order Number: 298001706_1_1
 Customer Ref: 21-2098.04
 National Grid Reference: 482570, 381420
 Slice: B
 Site Area (Ha): 1355.61
 Search Buffer (m): 100

Site Details

West Barton 2

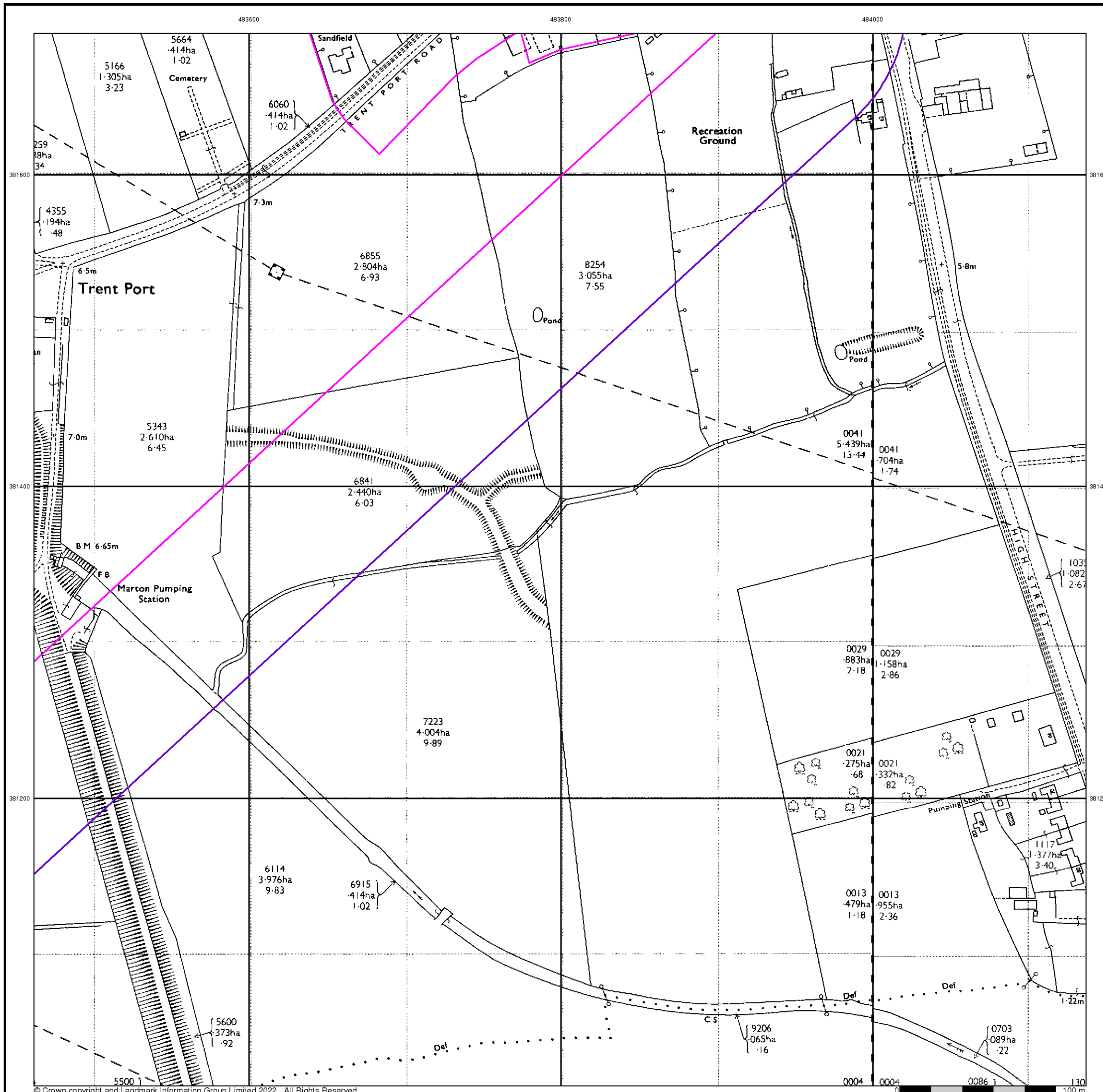

483600

483800

484000

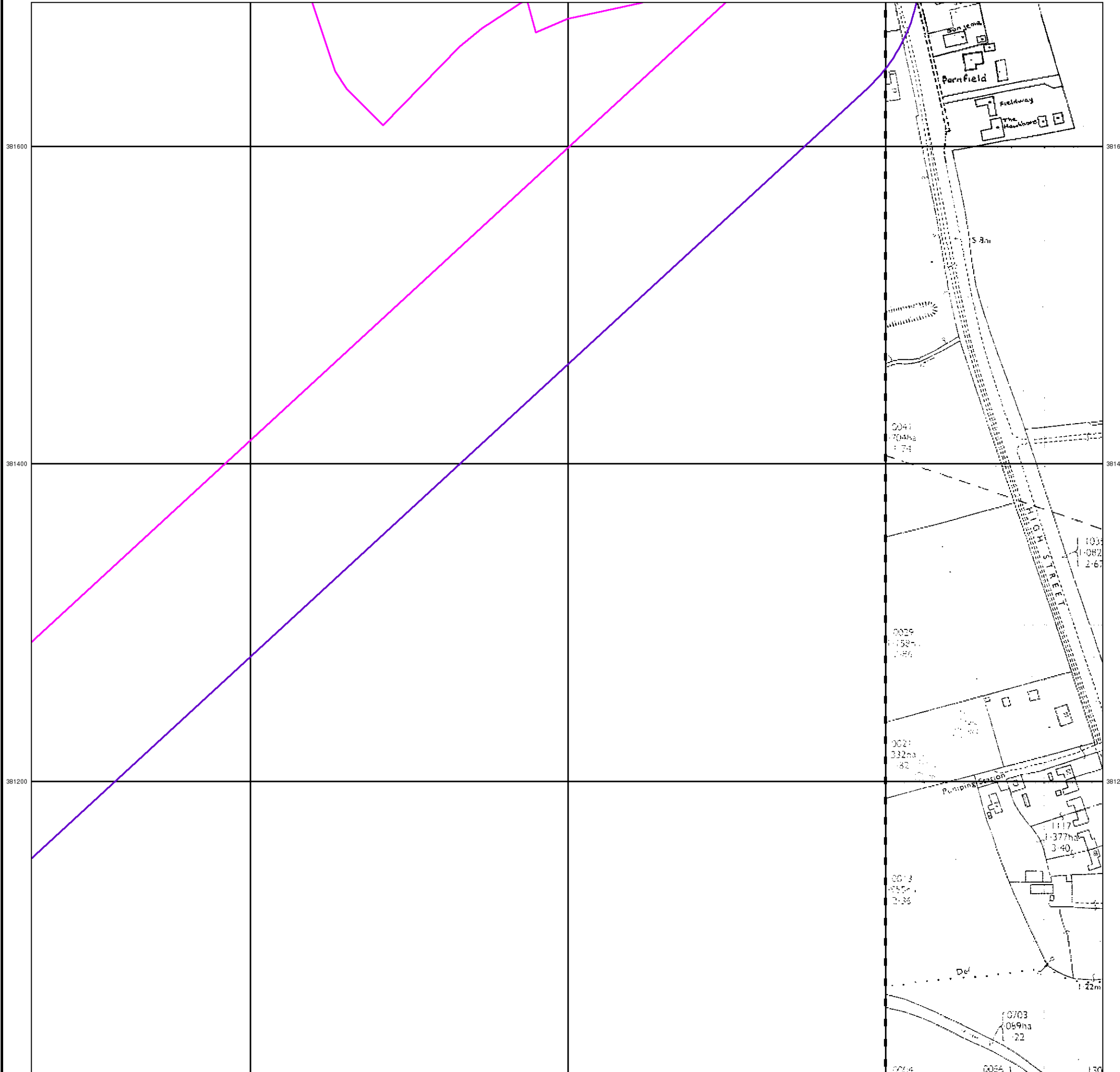

Additional SIMs

Published 1993

Source map scale - 1:2,500

The SIM cards (Ordnance Survey's 'Survey of Information on Microfilm') are further, minor editions of mapping which were produced and published in between the main editions as an area was updated. They date from 1947 to 1994, and contain detailed information on buildings, roads and land-use. These maps were produced at both 1:2,500 and 1:1,250 scales.

Map Name(s) and Date(s)

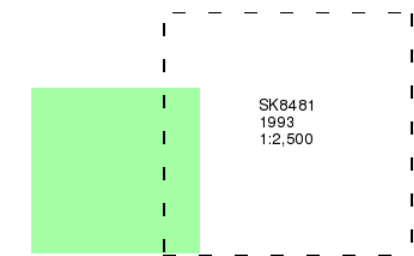

Historical Map - Segment B12

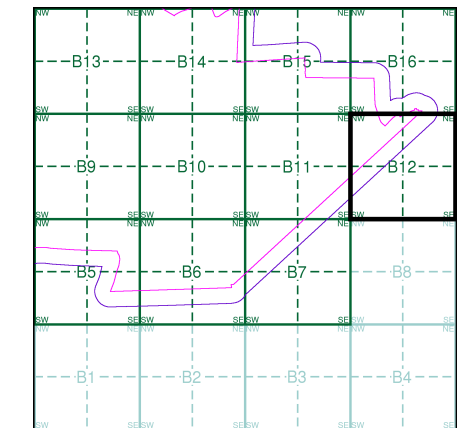

Order Details

Order Number: 298001706_1_1
 Customer Ref: 21-2098.04
 National Grid Reference: 482570, 381420
 Slice: B
 Site Area (Ha): 1355.61
 Search Buffer (m): 100

Site Details

West Barton 2



Tel: 0844 844 9952
 Fax: 0844 844 9951
 Web: [REDACTED]

Large-Scale National Grid Data

Published 1994

Source map scale - 1:2,500

'Large Scale National Grid Data' superseded SIM cards (Ordnance Survey's 'Survey of Information on Microfilm') in 1992, and continued to be produced until 1999. These maps were the fore-runners of digital mapping and so provide detailed information on houses and roads, but tend to show less topographic features such as vegetation. These maps were produced at both 1:2,500 and 1:1,250 scales.

Map Name(s) and Date(s)

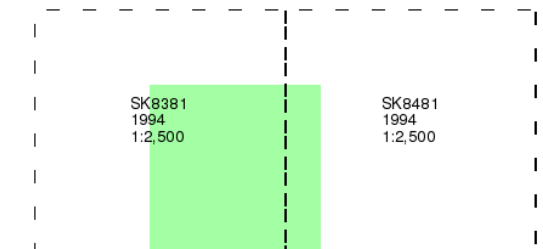

Historical Map - Segment B12

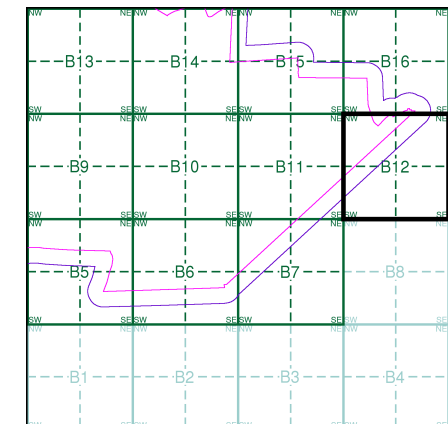

Order Details

Order Number: 298001706_1_1
 Customer Ref: 21-2098.04
 National Grid Reference: 482570, 381420
 Slice: B
 Site Area (Ha): 1355.61
 Search Buffer (m): 100

Site Details

West Barton 2

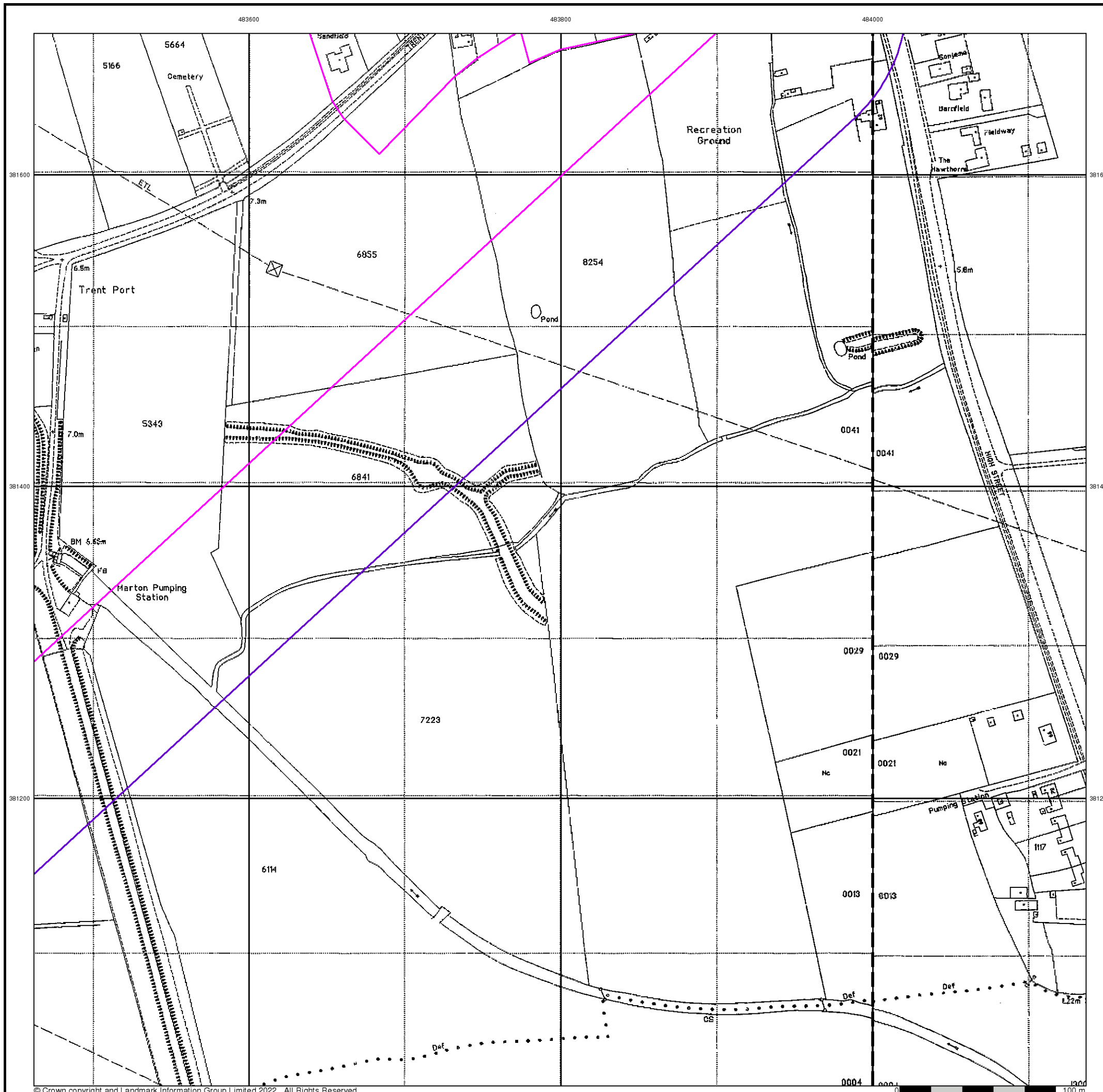

Historical Mapping Legends

Ordnance Survey County Series and Ordnance Survey Plan 1:2,500

Quarry **Gravel Pit** **Sand Pit**
Clay Pit **Shingle** **Refuse Heap**
Sloping Masonry **Flat Rock**
Marsh **Reeds** **Osiers**
Rough Pasture **Furze** **Wood**
Mixed Wood **Brushwood** **Orchard**
Fir **Ford** **Stepping Stones**
Ferry **Waterfall** **Lock**
Trig. Station **Altitude at Trig. Station**
B.M. 325.9 **Bench Mark** **Surface Level**
Arrow denotes flow of water **Antiquities (site of)**
Cutting **Embankment**
Railway crossing Road **Level Crossing** **Road crossing Railway**
Railway crossing River or Canal **Road over single stream** **Road over River or Canal**
County Boundary (Geographical)
County & Civil Parish Boundary
Administrative County & Civil Parish Boundary
County Borough Boundary (England)
Co. Boro. Bdy.
County Burgh Boundary (Scotland)
Boundary Post or Stone **Police Call Box**
B.R. **Bridle Road** **P** **Pump**
E.P **Electricity Pylon** **S.P** **Signal Post**
F.B. **Foot Bridge** **Sl** **Sluice**
F.P. **Foot Path** **Sp.** **Spring**
G.P **Guide Post or Board** **T.C.B** **Telephone Call Box**
M.S **Mile Stone** **Tr.** **Trough**
M.P M.R **Mooring Post or Ring** **W** **Well**

Ordnance Survey Plan, Additional SIMs and Supply of Unpublished Survey Information 1:2,500 and 1:1,250

Inactive Quarry, Chalk Pit or Clay Pit **Active Quarry, Chalk Pit or Clay Pit**
Rock **Boulders**
Cliff **Slopes** **Top**
Roofed Building **Glazed Roof Building**
Sloping Masonry **Archway**
Non-Coniferous Tree (surveyed) **Coniferous Tree (surveyed)**
Non-Coniferous Trees (not surveyed) **Coniferous Trees (not surveyed)**
Orchard Tree **Scrub** **Bracken**
Coppice, Osier **Reeds** **Marsh, Saltings**
Rough Grassland **Heath** **Culvert**
Direction of water flow **Bench Mark** **Antiquity (site of)**
Cave Entrance **Triangulation Station** **Electricity Pylon**
Electricity Transmission Line
County Boundary (Geographical)
County & Civil Parish Boundary
Civil Parish Boundary
Admin. County or County Bor. Boundary
London Borough Boundary
Symbol marking point where boundary mereing changes
Beer House **Pillar, Pole or Post**
Boundary Post or Stone **Post Office**
Capstan, Crane **Public Convenience**
Chimney **Public House**
Drinking Fountain **Pump**
Electricity Pillar or Post **Signal Box or Bridge**
Fire Alarm Pillar **Signal Post or Light**
Foot Bridge **Spring**
Guide Post **Tank or Track**
Hydrant or Hydraulic **Telephone Call Box**
Level Crossing **Telephone Call Post**
Manhole **Trough**
Mile Post or Mooring Post **Water Point, Water Tap**
Mile Stone **Well**
Normal Tidal Limit **Wind Pump**

Large-Scale National Grid Data 1:2,500 and 1:1,250

Cliff **Slopes** **Top**
Rock **Rock (scattered)**
Boulders **Boulders (scattered)**
Positioned Boulder **Scree**
Non-Coniferous Tree (surveyed) **Coniferous Tree (surveyed)**
Non-Coniferous Trees (not surveyed) **Coniferous Trees (not surveyed)**
Orchard Tree **Scrub** **Bracken**
Coppice, Osier **Reeds** **Marsh, Saltings**
Rough Grassland **Heath** **Culvert**
Direction of water flow **Triangulation Station** **Antiquity (site of)**
Electricity Transmission Line **Electricity Pylon**
Bench Mark **Buildings with Building Seed**
Roofed Building **Glazed Roof Building**
Civil parish/community boundary
District boundary
County boundary
Boundary post/stone
Boundary mereing symbol (note: these always appear in opposed pairs or groups of three)
Barracks **Pillar, Pole or Post**
Battery **Post Office**
Cemetery **Public Convenience**
Chimney **Pump**
Cistern **Pumping Station**
Dismtd Rly **Place of Worship**
Electricity Generating Station **Sewage Ppg Sta** **Sewage Pumping Station**
Electricity Pole, Pillar **Signal Box or Bridge**
Electricity Sub Station **Signal Post or Light**
Filter Bed **Spring**
Fountain / Drinking Ftn. **Tank or Track**
Gas Valve Compound **Trough**
Gas Governor **Wind Pump**
Guide Post **Water Point, Water Tap**
Manhole **Works (building or area)**
Mile Post or Mile Stone **Well**

Historical Mapping & Photography included:

Mapping Type	Scale	Date	Pg
Lincolnshire	1:2,500	1886	2
Nottinghamshire	1:2,500	1886	3
Nottinghamshire	1:2,500	1899	4
Lincolnshire	1:2,500	1920	5
Nottinghamshire	1:2,500	1920	6
Ordnance Survey Plan	1:2,500	1974 - 1975	7
Large-Scale National Grid Data	1:2,500	1994	8

Historical Map - Segment B13

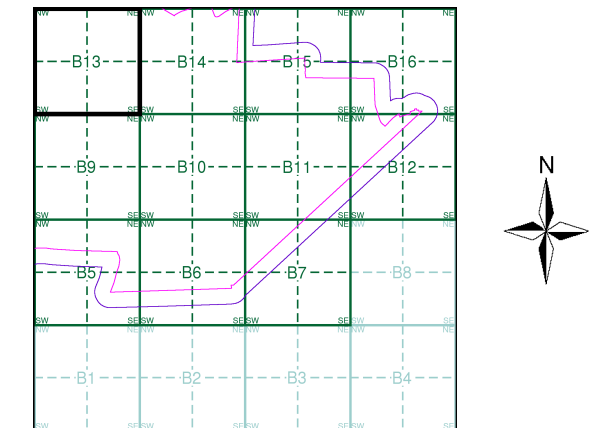

Order Details

Order Number: 298001706_1_1
 Customer Ref: 21-2098.04
 National Grid Reference: 482570, 381420
 Slice: B
 Site Area (Ha): 1355.61
 Search Buffer (m): 100

Site Details

West Barton 2

Lincolnshire
Published 1886

Source map scale - 1:2,500

The historical maps shown were reproduced from maps predominantly held at the scale adopted for England, Wales and Scotland in the 1840's. In 1854 the 1:2,500 scale was adopted for mapping urban areas and by 1896 it covered the whole of what were considered to be the cultivated parts of Great Britain. The published date given below is often some years later than the surveyed date. Before 1938, all OS maps were based on the Cassini Projection, with independent surveys of a single county or group of counties, giving rise to significant inaccuracies in outlying areas.

Map Name(s) and Date(s)

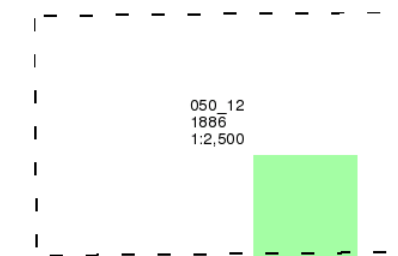

Historical Map - Segment B13

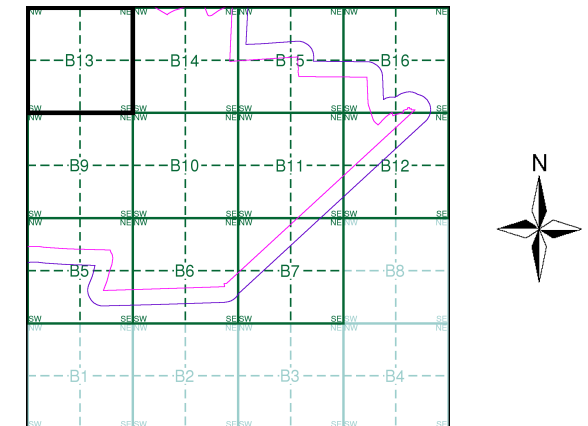

Order Details

Order Number: 298001706_1_1
 Customer Ref: 21-2098.04
 National Grid Reference: 482570, 381420
 Slice: B
 Site Area (Ha): 1355.61
 Search Buffer (m): 100

Site Details

West Barton 2

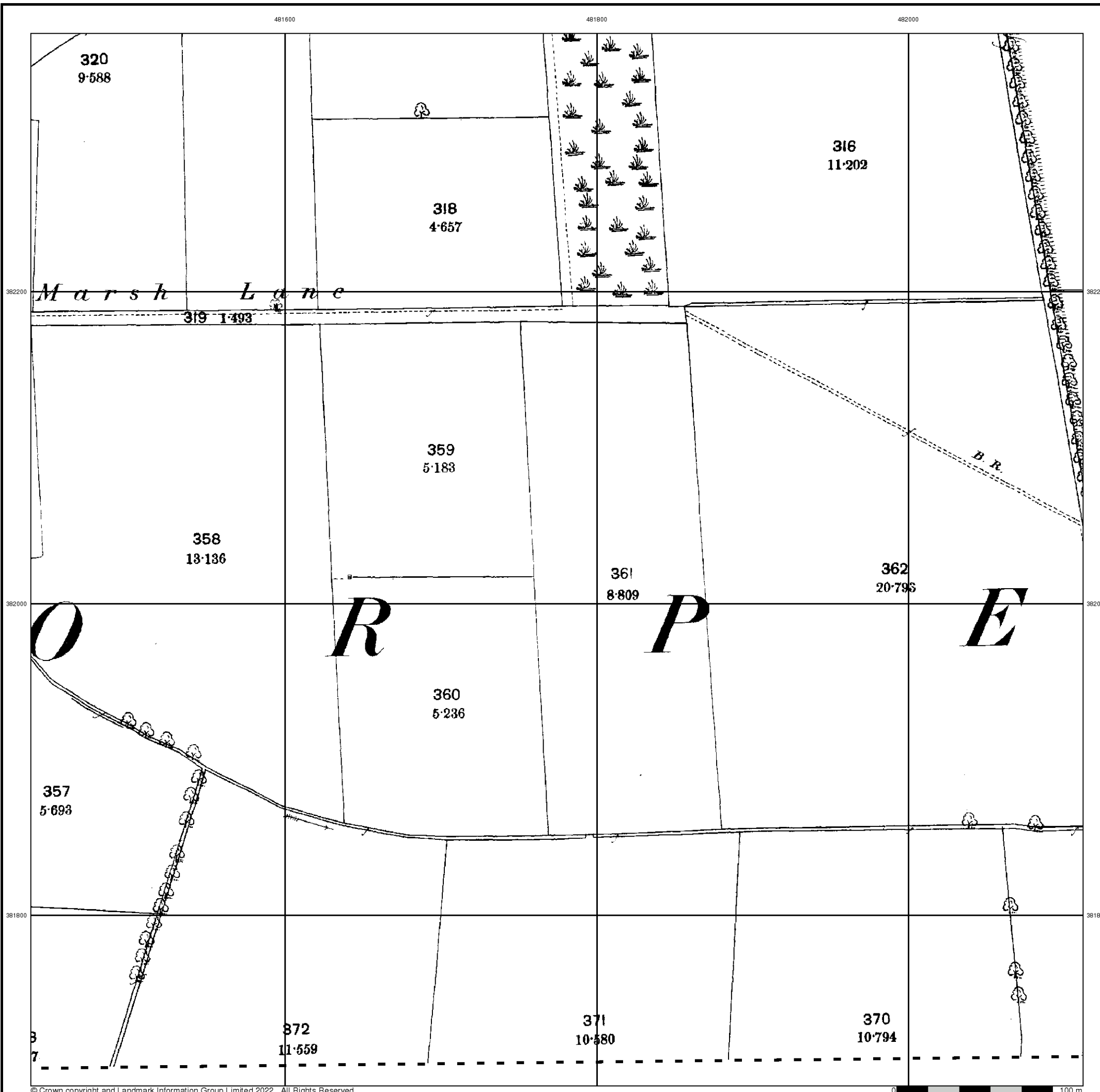

481600

481800

482000

382200

382200

382000

382000

381800

381800



Nottinghamshire

Published 1886

Source map scale - 1:2,500

The historical maps shown were reproduced from maps predominantly held at the scale adopted for England, Wales and Scotland in the 1840's. In 1854 the 1:2,500 scale was adopted for mapping urban areas and by 1896 it covered the whole of what were considered to be the cultivated parts of Great Britain. The published date given below is often some years later than the surveyed date. Before 1938, all OS maps were based on the Cassini Projection, with independent surveys of a single county or group of counties, giving rise to significant inaccuracies in outlying areas.

Map Name(s) and Date(s)

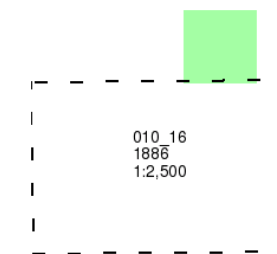

Historical Map - Segment B13

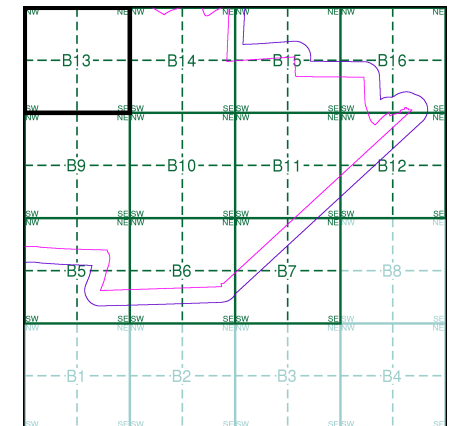

Order Details

Order Number: 298001706_1_1
Customer Ref: 21-2098.04
National Grid Reference: 482570, 381420
Slice: B
Site Area (Ha): 1355.61
Search Buffer (m): 100

Site Details

West Barton 2



Tel: 0844 844 9952
Fax: 0844 844 9951
Web: [REDACTED]

Nottinghamshire

Published 1899

Source map scale - 1:2,500

The historical maps shown were reproduced from maps predominantly held at the scale adopted for England, Wales and Scotland in the 1840's. In 1854 the 1:2,500 scale was adopted for mapping urban areas and by 1896 it covered the whole of what were considered to be the cultivated parts of Great Britain. The published date given below is often some years later than the surveyed date. Before 1938, all OS maps were based on the Cassini Projection, with independent surveys of a single county or group of counties, giving rise to significant inaccuracies in outlying areas.

Map Name(s) and Date(s)

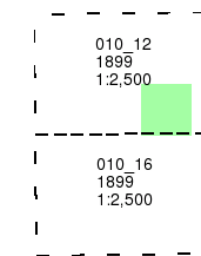

Historical Map - Segment B13

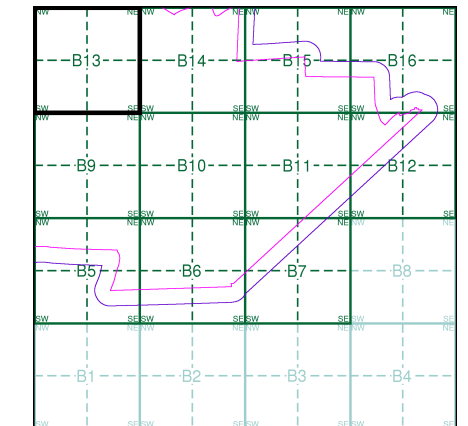

Order Details

Order Number: 298001706_1_1
 Customer Ref: 21-2098.04
 National Grid Reference: 482570, 381420
 Slice: B
 Site Area (Ha): 1355.61
 Search Buffer (m): 100

Site Details

West Barton 2

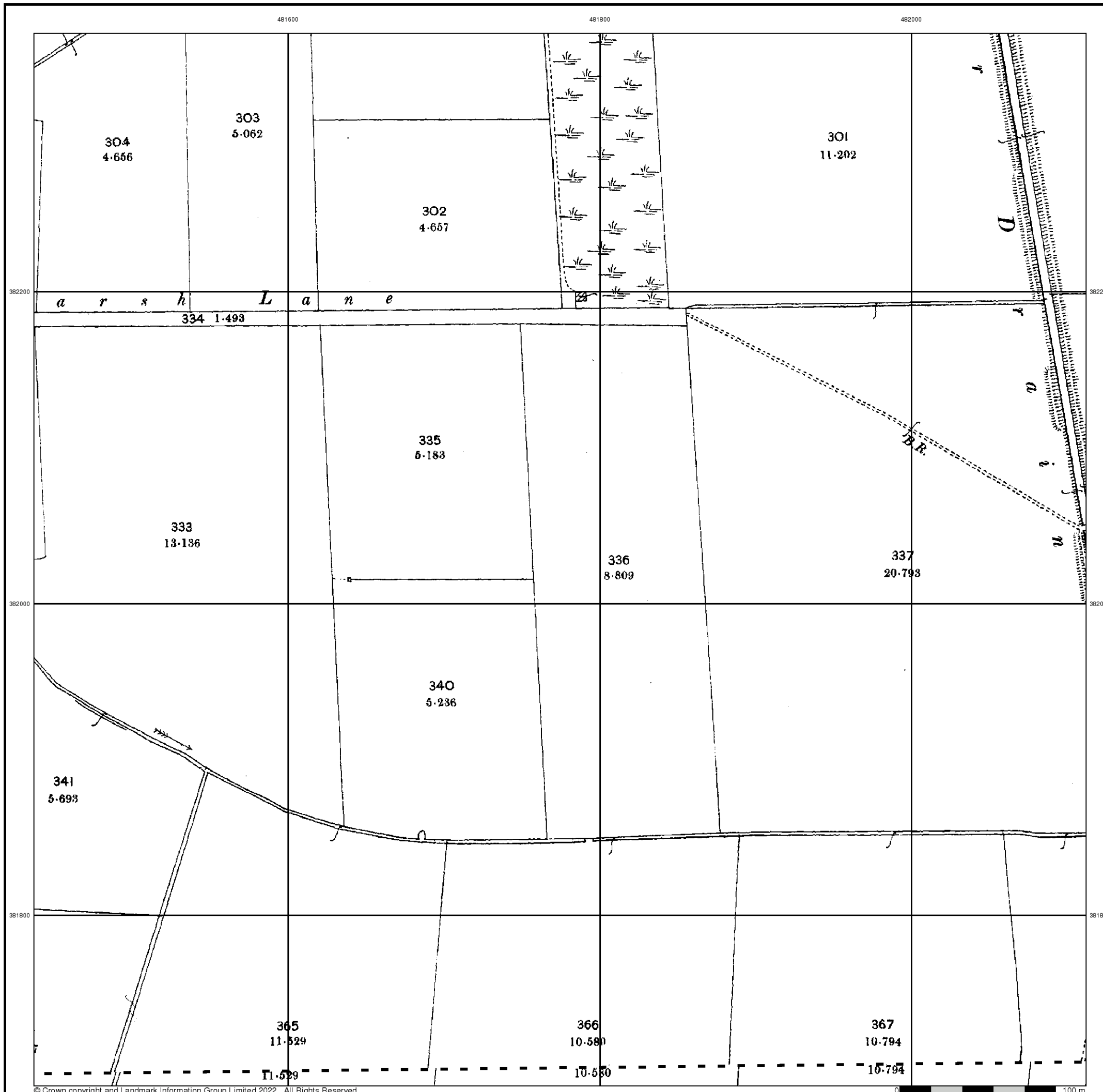

Lincolnshire

Published 1920

Source map scale - 1:2,500

The historical maps shown were reproduced from maps predominantly held at the scale adopted for England, Wales and Scotland in the 1840's. In 1854 the 1:2,500 scale was adopted for mapping urban areas and by 1896 it covered the whole of what were considered to be the cultivated parts of Great Britain. The published date given below is often some years later than the surveyed date. Before 1938, all OS maps were based on the Cassini Projection, with independent surveys of a single county or group of counties, giving rise to significant inaccuracies in outlying areas.

Map Name(s) and Date(s)

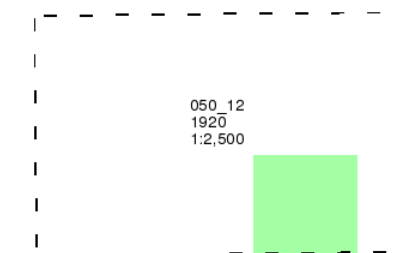

Historical Map - Segment B13

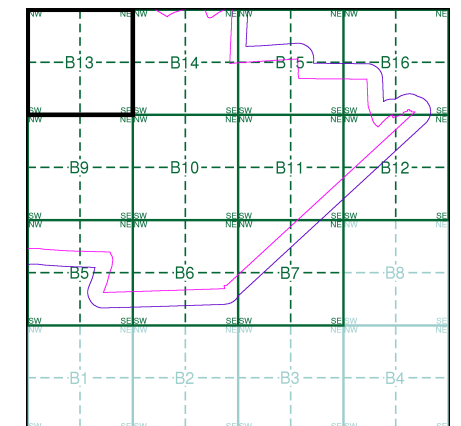

Order Details

Order Number: 298001706_1_1
 Customer Ref: 21-2098.04
 National Grid Reference: 482570, 381420
 Slice: B
 Site Area (Ha): 1355.61
 Search Buffer (m): 100

Site Details

West Barton 2



Nottinghamshire

Published 1920

Source map scale - 1:2,500

The historical maps shown were reproduced from maps predominantly held at the scale adopted for England, Wales and Scotland in the 1840's. In 1854 the 1:2,500 scale was adopted for mapping urban areas and by 1896 it covered the whole of what were considered to be the cultivated parts of Great Britain. The published date given below is often some years later than the surveyed date. Before 1938, all OS maps were based on the Cassini Projection, with independent surveys of a single county or group of counties, giving rise to significant inaccuracies in outlying areas.

Map Name(s) and Date(s)

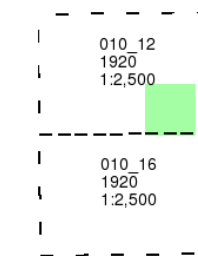

Historical Map - Segment B13

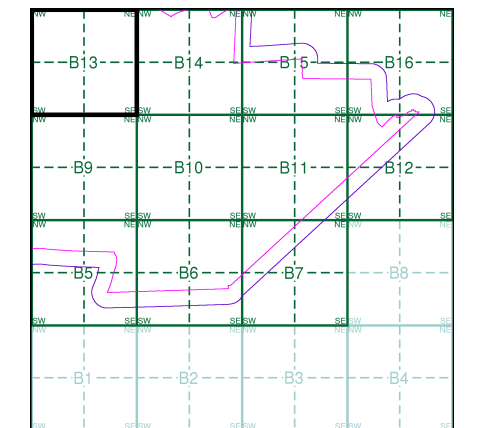

Order Details

Order Number: 298001706_1_1
 Customer Ref: 21-2098.04
 National Grid Reference: 482570, 381420
 Slice: B
 Site Area (Ha): 1355.61
 Search Buffer (m): 100

Site Details

West Barton 2

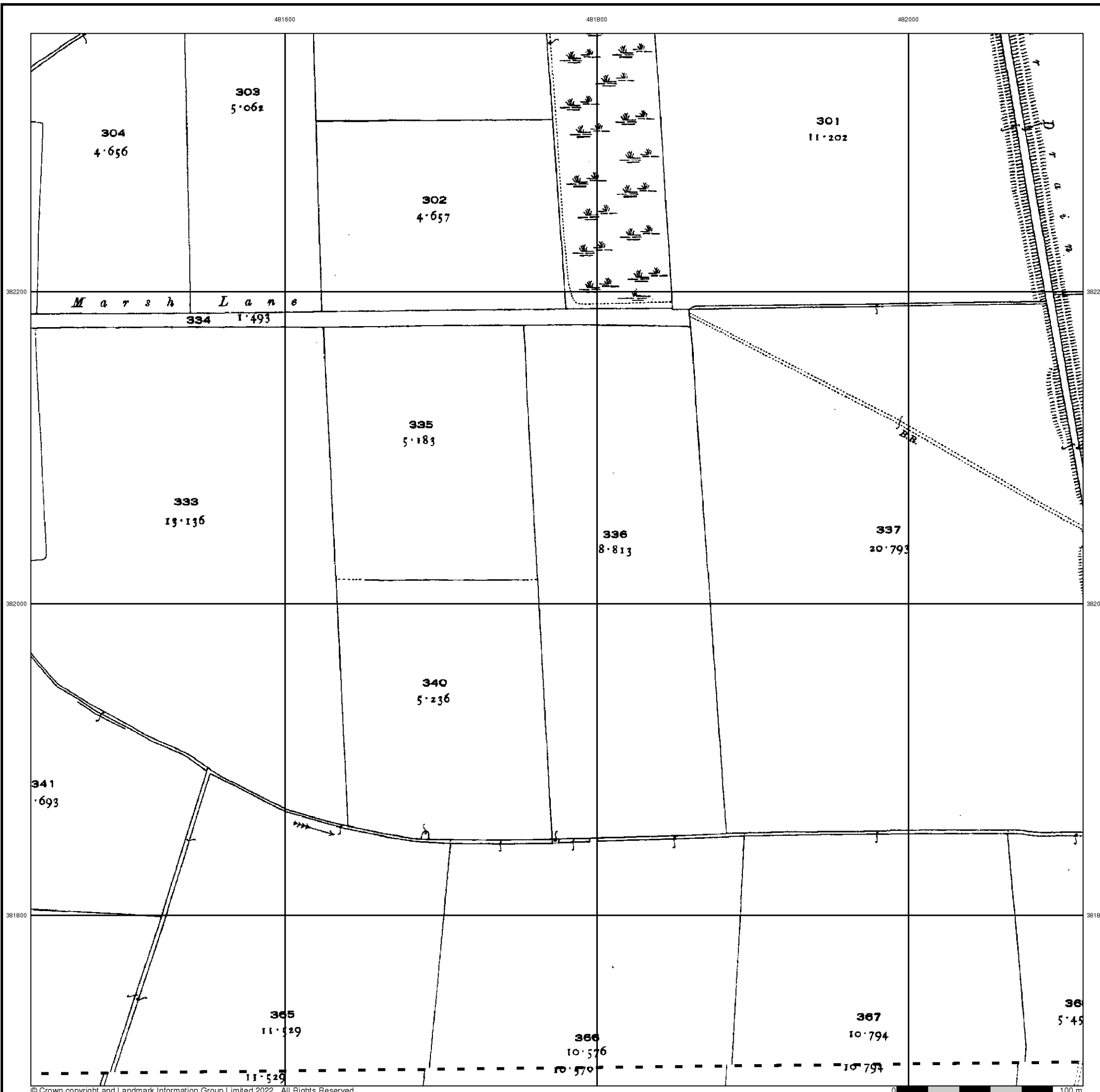

Ordnance Survey Plan
Published 1974 - 1975
Source map scale - 1:2,500

The historical maps shown were reproduced from maps predominantly held at the scale adopted for England, Wales and Scotland in the 1840's. In 1854 the 1:2,500 scale was adopted for mapping urban areas and by 1896 it covered the whole of what were considered to be the cultivated parts of Great Britain. The published date given below is often some years later than the surveyed date. Before 1938, all OS maps were based on the Cassini Projection, with independent surveys of a single county or group of counties, giving rise to significant inaccuracies in outlying areas.

Map Name(s) and Date(s)

SK8182 1974 1:2,500	SK8282 1975 1:2,500
SK8181 1974 1:2,500	SK8281 1975 1:2,500

Historical Map - Segment B13

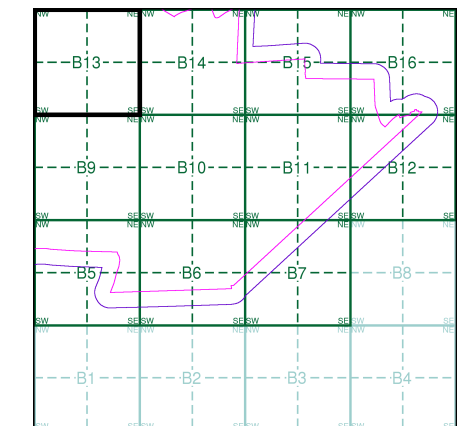

Order Details

Order Number: 298001706_1_1
 Customer Ref: 21-2098.04
 National Grid Reference: 482570, 381420
 Slice: B
 Site Area (Ha): 1355.61
 Search Buffer (m): 100

Site Details

West Barton 2

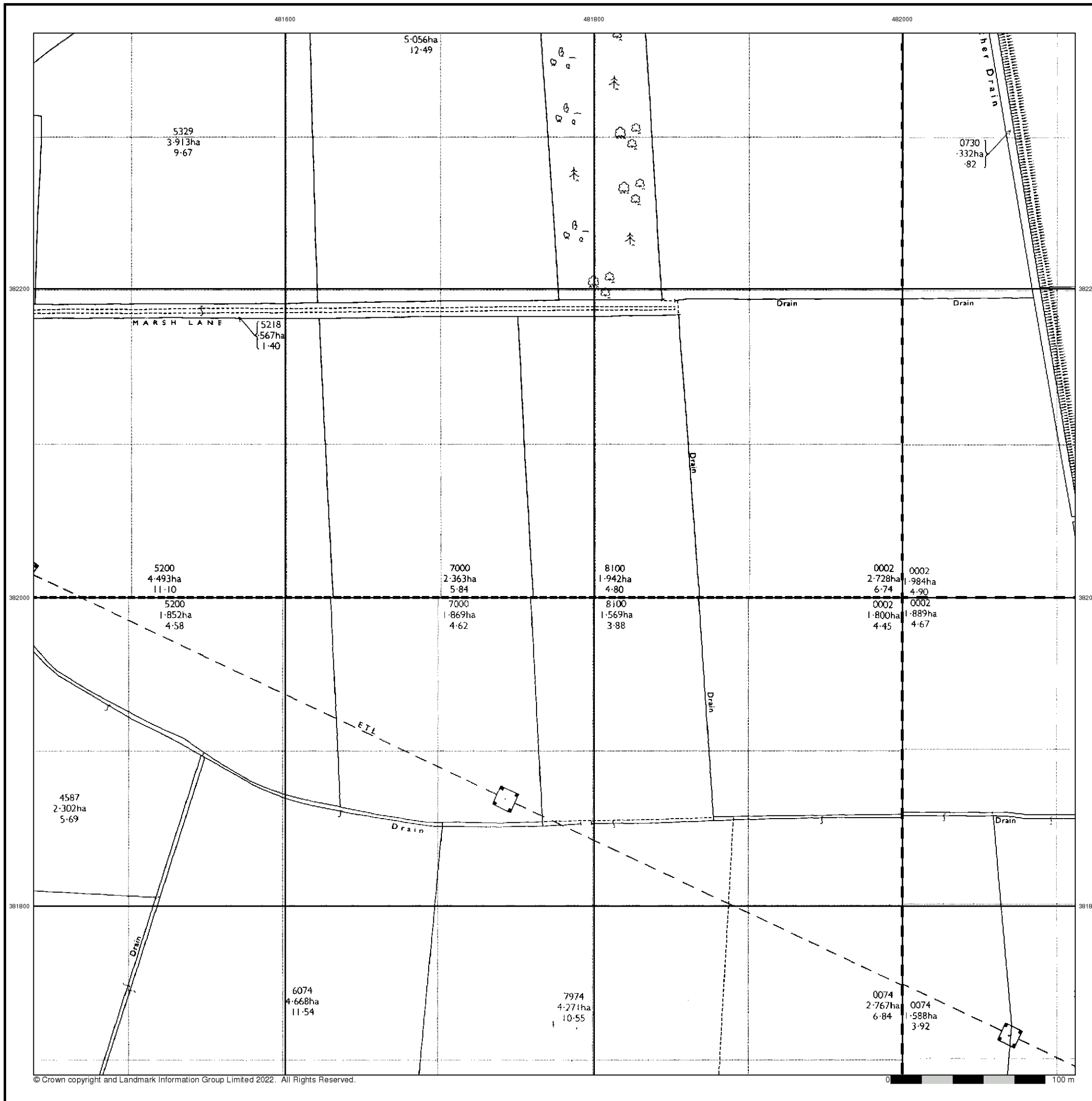

Large-Scale National Grid Data

Published 1994

Source map scale - 1:2,500

'Large Scale National Grid Data' superseded SIM cards (Ordnance Survey's 'Survey of Information on Microfilm') in 1992, and continued to be produced until 1999. These maps were the fore-runners of digital mapping and so provide detailed information on houses and roads, but tend to show less topographic features such as vegetation. These maps were produced at both 1:2,500 and 1:1,250 scales.

Map Name(s) and Date(s)

SK8182	SK8282
1994	1994
1:2,500	1:2,500
SK8181	SK8281
1994	1994
1:2,500	1:2,500

Historical Map - Segment B13

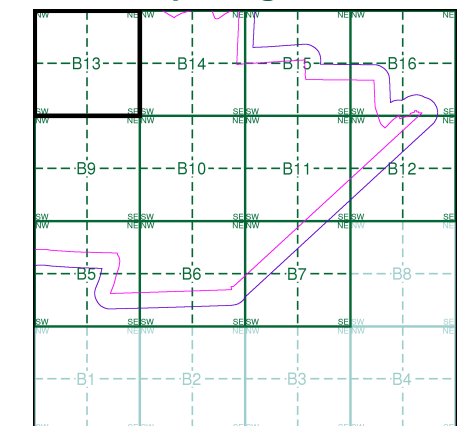

Order Details

Order Number: 298001706_1_1
 Customer Ref: 21-2098.04
 National Grid Reference: 482570, 381420
 Slice: B
 Site Area (Ha): 1355.61
 Search Buffer (m): 100

Site Details

West Barton 2

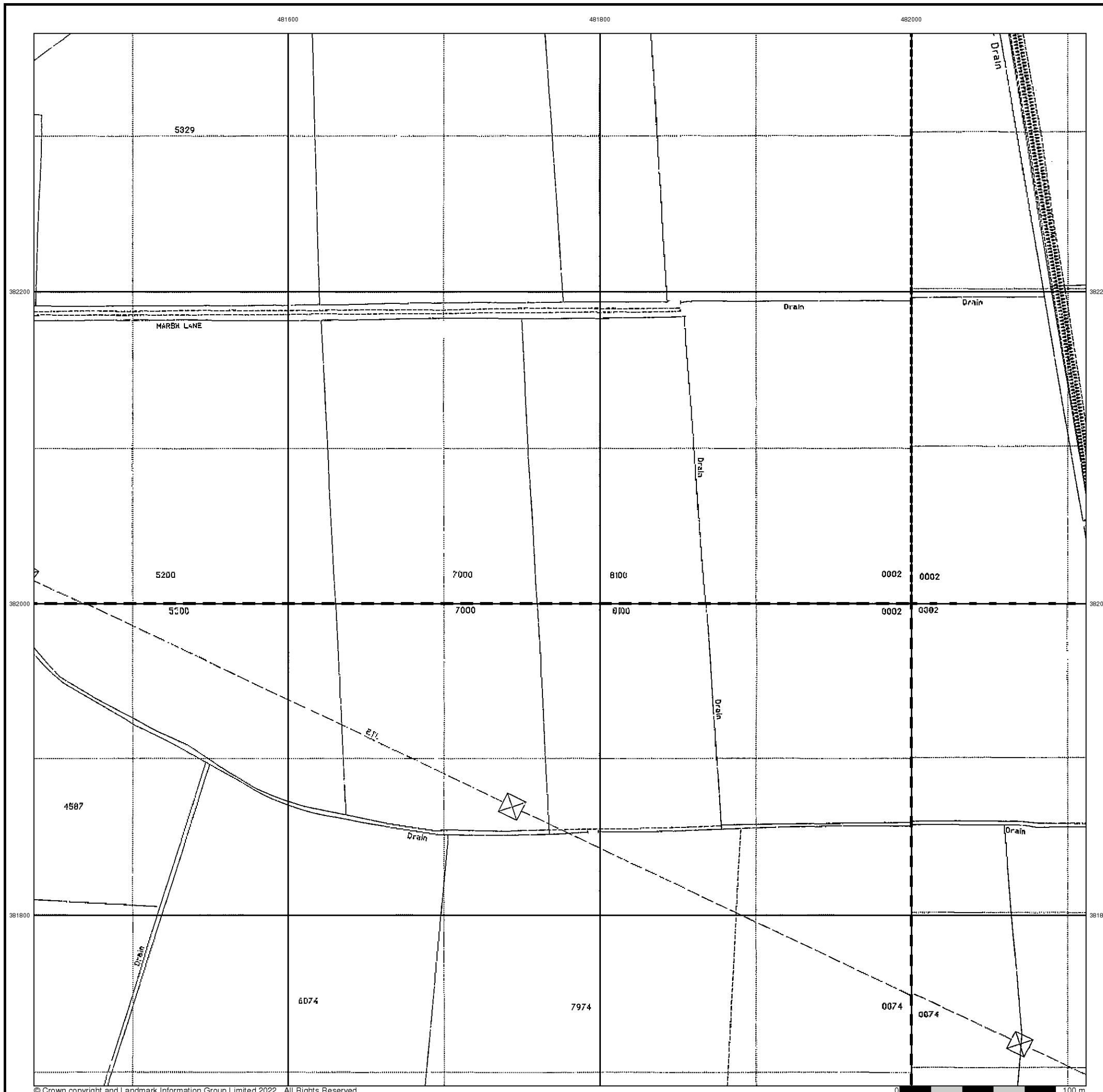

Historical Mapping Legends

Ordnance Survey County Series and Ordnance Survey Plan 1:2,500

Quarry **Gravel Pit** **Sand Pit**
Clay Pit **Shingle** **Refuse Heap**
Sloping Masonry **Flat Rock**
Marsh **Reeds** **Osiers**
Rough Pasture **Furze** **Wood**
Mixed Wood **Brushwood** **Orchard**
Fir **Ford** **Stepping Stones**
Ferry **Waterfall** **Lock**
Trig. Station 507 **Altitude at Trig. Station**
B.M. 325.9 **Bench Mark** 342 **Surface Level**
Arrow denotes flow of water **Antiquities (site of)**
Cutting **Embankment**
Railway crossing Road **Level Crossing** **Road crossing Railway**
Railway crossing River or Canal **Road over single stream** **Road over River or Canal**
County Boundary (Geographical)
County & Civil Parish Boundary
Administrative County & Civil Parish Boundary
County Borough Boundary (England)
Co. Boro. Bdy.
County Burgh Boundary (Scotland)
Boundary Post or Stone **P.C.B. Police Call Box**
B.R. Bridle Road **P. Pump**
E.P. Electricity Pylon **S.P. Signal Post**
F.B. Foot Bridge **Sl. Sluice**
F.P. Foot Path **Sp. Spring**
G.P. Guide Post or Board **T.C.B. Telephone Call Box**
M.S. Mile Stone **Tr. Trough**
M.P. M.R. Mooring Post or Ring **W. Well**

Ordnance Survey Plan, Additional SIMs and Supply of Unpublished Survey Information 1:2,500 and 1:1,250

Inactive Quarry, Chalk Pit or Clay Pit **Active Quarry, Chalk Pit or Clay Pit**
Rock **Boulders**
Cliff **Slopes** **Top**
Roofed Building **Glazed Roof Building**
Sloping Masonry **Archway**
Non-Coniferous Tree (surveyed) **Coniferous Tree (surveyed)**
Non-Coniferous Trees (not surveyed) **Coniferous Trees (not surveyed)**
Orchard Tree **Scrub** **Bracken**
Coppice, Osier **Reeds** **Marsh, Saltings**
Rough Grassland **Heath** **Culvert**
Direction of water flow **Bench Mark** **Antiquity (site of)**
Cave Entrance **Triangulation Station** **Electricity Pylon**
Electricity Transmission Line
County Boundary (Geographical)
County & Civil Parish Boundary
Civil Parish Boundary
Admin. County or County Bor. Boundary
London Borough Boundary
Symbol marking point where boundary mereing changes
BH Beer House **P. Pillar, Pole or Post**
BP, BS Boundary Post or Stone **PO Post Office**
Cn, C Capstan, Crane **PC Public Convenience**
Chy Chimney **PH Public House**
D Fn Drinking Fountain **Pp Pump**
EI P Electricity Pillar or Post **SB, S Br Signal Box or Bridge**
FAP Fire Alarm Pillar **SP, SL Signal Post or Light**
FB Foot Bridge **Spr Spring**
GP Guide Post **Tk Tank or Track**
H Hydrant or Hydraulic **TCB Telephone Call Box**
LC Level Crossing **TCP Telephone Call Post**
MH Manhole **Tr Trough**
MP Mile Post or Mooring Post **Wr Pt, Wr T Water Point, Water Tap**
MS Mile Stone **W Well**
NTL Normal Tidal Limit **Wd Pp Wind Pump**

Large-Scale National Grid Data 1:2,500 and 1:1,250

Cliff **Slopes** **Top**
Rock **Rock (scattered)**
Boulders **Boulders (scattered)**
Positioned Boulder **Scree**
Non-Coniferous Tree (surveyed) **Coniferous Tree (surveyed)**
Non-Coniferous Trees (not surveyed) **Coniferous Trees (not surveyed)**
Orchard Tree **Scrub** **Bracken**
Coppice, Osier **Reeds** **Marsh, Saltings**
Rough Grassland **Heath** **Culvert**
Direction of water flow **Triangulation Station** **Antiquity (site of)**
Electricity Transmission Line **Electricity Pylon**
B.M. 231.60m Bench Mark **Buildings with Building Seed**
Roofed Building **Glazed Roof Building**
Civil parish/community boundary
District boundary
County boundary
Boundary post/stone
Boundary mereing symbol (note: these always appear in opposed pairs or groups of three)
Bks Barracks **P. Pillar, Pole or Post**
Bty Battery **PO Post Office**
Cemy Cemetery **PC Public Convenience**
Chy Chimney **Pp Pump**
Cis Cistern **Ppg Sta Pumping Station**
Dismtd Rly Dismantled Railway **PW Place of Worship**
EI Gen Sta Electricity Generating Station **Sewage Ppg Sta Sewage Pumping Station**
EI P Electricity Pole, Pillar **SB, S Br Signal Box or Bridge**
EI Sub Sta Electricity Sub Station **SP, SL Signal Post or Light**
FB Filter Bed **Spr Spring**
Fn / D Fn Fountain / Drinking Ftn. **Tk Tank or Track**
Gas Gov Gas Valve Compound **Tr Trough**
GVC Gas Governor **Wd Pp Wind Pump**
GP Guide Post **Wr Pt, Wr T Water Point, Water Tap**
MH Manhole **Wks Works (building or area)**
MP, MS Mile Post or Mile Stone **W Well**

Historical Mapping & Photography included:

Mapping Type	Scale	Date	Pg
Nottinghamshire	1:2,500	1886	2
Lincolnshire	1:2,500	1886	3
Nottinghamshire	1:2,500	1899	4
Nottinghamshire	1:2,500	1920	5
Lincolnshire	1:2,500	1920	6
Ordnance Survey Plan	1:2,500	1975	7
Large-Scale National Grid Data	1:2,500	1994	8

Historical Map - Segment B14

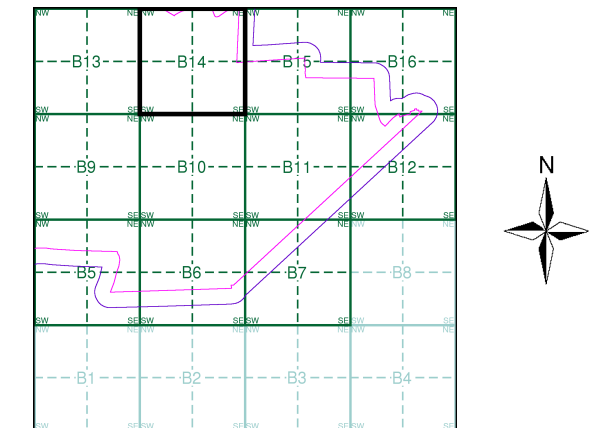

Order Details

Order Number: 298001706_1_1
 Customer Ref: 21-2098.04
 National Grid Reference: 482570, 381420
 Slice: B
 Site Area (Ha): 1355.61
 Search Buffer (m): 100

Site Details

West Barton 2

482200

482400

482600

382200

382200

382000

382000

381800

381800



Nottinghamshire

Published 1886

Source map scale - 1:2,500

The historical maps shown were reproduced from maps predominantly held at the scale adopted for England, Wales and Scotland in the 1840's. In 1854 the 1:2,500 scale was adopted for mapping urban areas and by 1896 it covered the whole of what were considered to be the cultivated parts of Great Britain. The published date given below is often some years later than the surveyed date. Before 1938, all OS maps were based on the Cassini Projection, with independent surveys of a single county or group of counties, giving rise to significant inaccuracies in outlying areas.

Map Name(s) and Date(s)

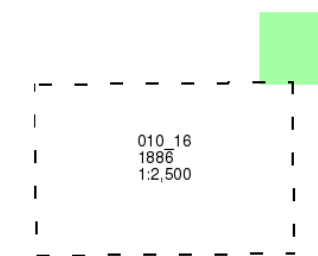

Historical Map - Segment B14

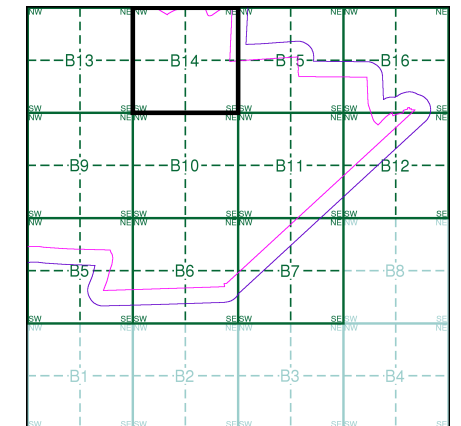

Order Details

Order Number: 298001706_1_1
Customer Ref: 21-2098.04
National Grid Reference: 482570, 381420
Slice: B
Site Area (Ha): 1355.61
Search Buffer (m): 100

Site Details

West Barton 2



Tel: 0844 844 9952
Fax: 0844 844 9951
Web: [REDACTED]

Lincolnshire
Published 1886

Source map scale - 1:2,500

The historical maps shown were reproduced from maps predominantly held at the scale adopted for England, Wales and Scotland in the 1840's. In 1854 the 1:2,500 scale was adopted for mapping urban areas and by 1896 it covered the whole of what were considered to be the cultivated parts of Great Britain. The published date given below is often some years later than the surveyed date. Before 1938, all OS maps were based on the Cassini Projection, with independent surveys of a single county or group of counties, giving rise to significant inaccuracies in outlying areas.

Map Name(s) and Date(s)

050_12 1886 1:2,500	051_09 1886 1:2,500
1	
051_13 1886 1:2,500	

Historical Map - Segment B14

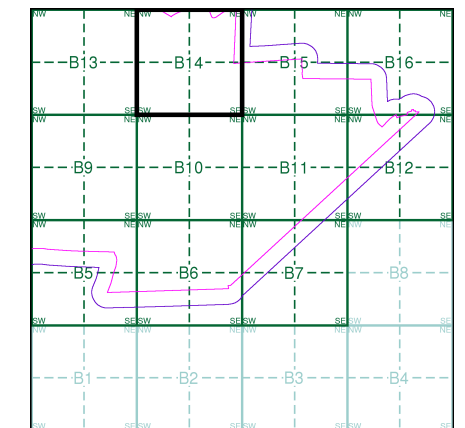

Order Details

Order Number: 298001706_1_1
Customer Ref: 21-2098.04
National Grid Reference: 482570, 381420
Slice: B
Site Area (Ha): 1355.61
Search Buffer (m): 100

Site Details

West Barton 2

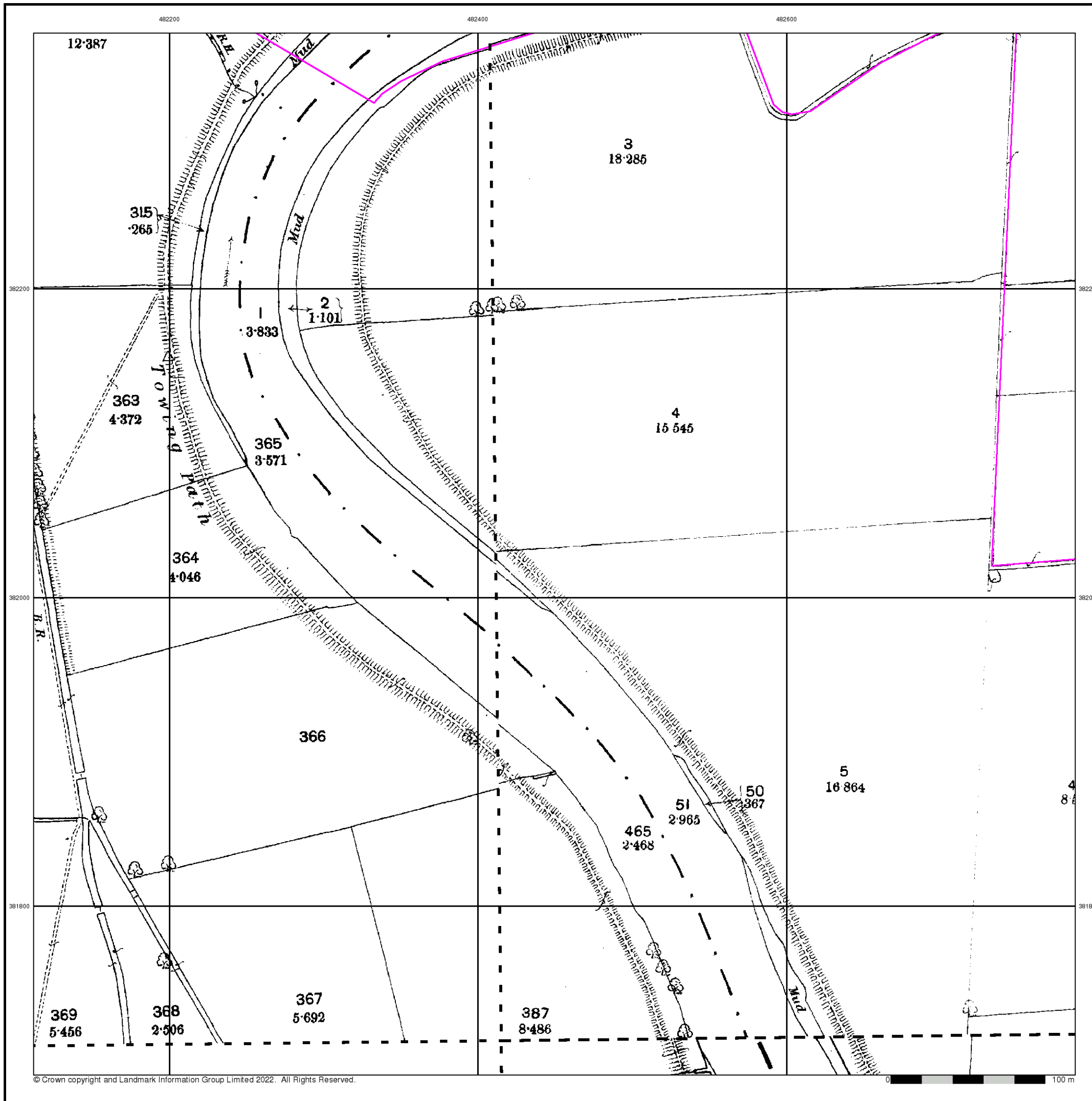

Nottinghamshire

Published 1899

Source map scale - 1:2,500

The historical maps shown were reproduced from maps predominantly held at the scale adopted for England, Wales and Scotland in the 1840's. In 1854 the 1:2,500 scale was adopted for mapping urban areas and by 1896 it covered the whole of what were considered to be the cultivated parts of Great Britain. The published date given below is often some years later than the surveyed date. Before 1938, all OS maps were based on the Cassini Projection, with independent surveys of a single county or group of counties, giving rise to significant inaccuracies in outlying areas.

Map Name(s) and Date(s)

010_12 1899 1:2,500	011_09 1899 1:2,500
010_16 1899 1:2,500	011_13 1899 1:2,500

Historical Map - Segment B14

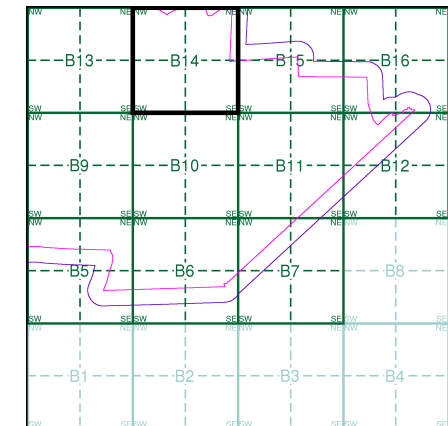

Order Details

Order Number: 298001706_1_1
 Customer Ref: 21-2098.04
 National Grid Reference: 482570, 381420
 Slice: B
 Site Area (Ha): 1355.61
 Search Buffer (m): 100

Site Details

West Barton 2

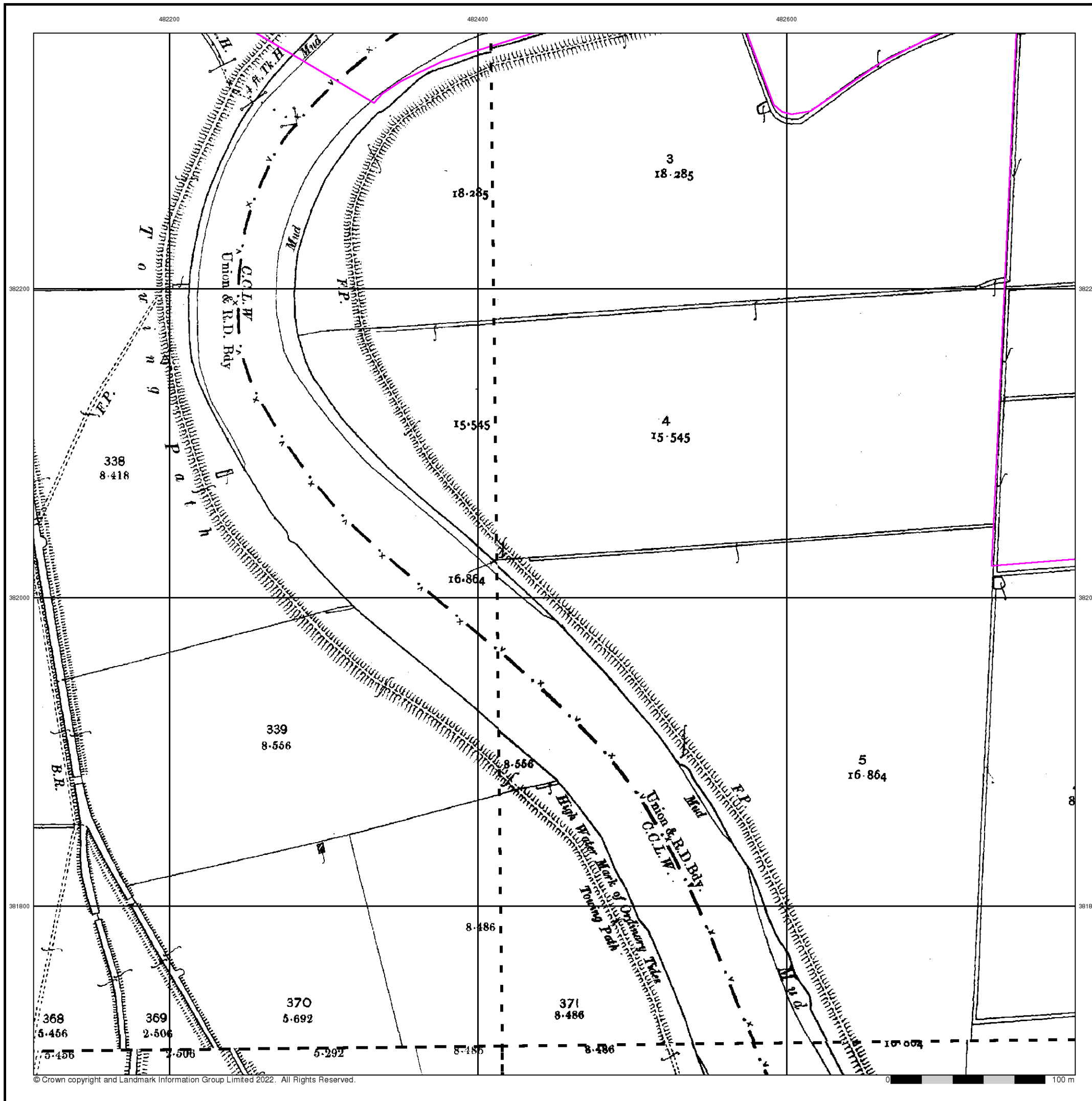

Nottinghamshire

Published 1920

Source map scale - 1:2,500

The historical maps shown were reproduced from maps predominantly held at the scale adopted for England, Wales and Scotland in the 1840's. In 1854 the 1:2,500 scale was adopted for mapping urban areas and by 1896 it covered the whole of what were considered to be the cultivated parts of Great Britain. The published date given below is often some years later than the surveyed date. Before 1938, all OS maps were based on the Cassini Projection, with independent surveys of a single county or group of counties, giving rise to significant inaccuracies in outlying areas.

Map Name(s) and Date(s)

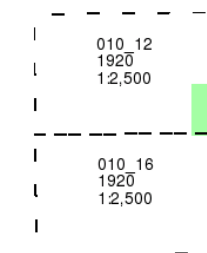

Historical Map - Segment B14

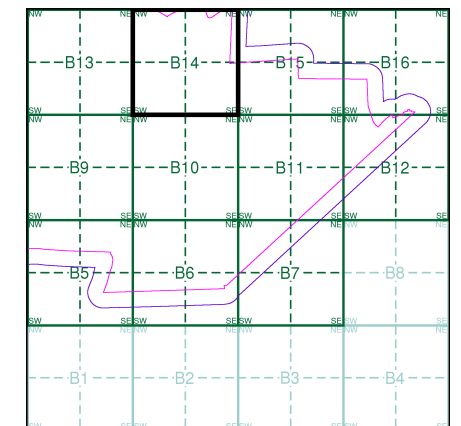

Order Details

Order Number: 298001706_1_1
 Customer Ref: 21-2098.04
 National Grid Reference: 482570, 381420
 Slice: B
 Site Area (Ha): 1355.61
 Search Buffer (m): 100

Site Details

West Barton 2

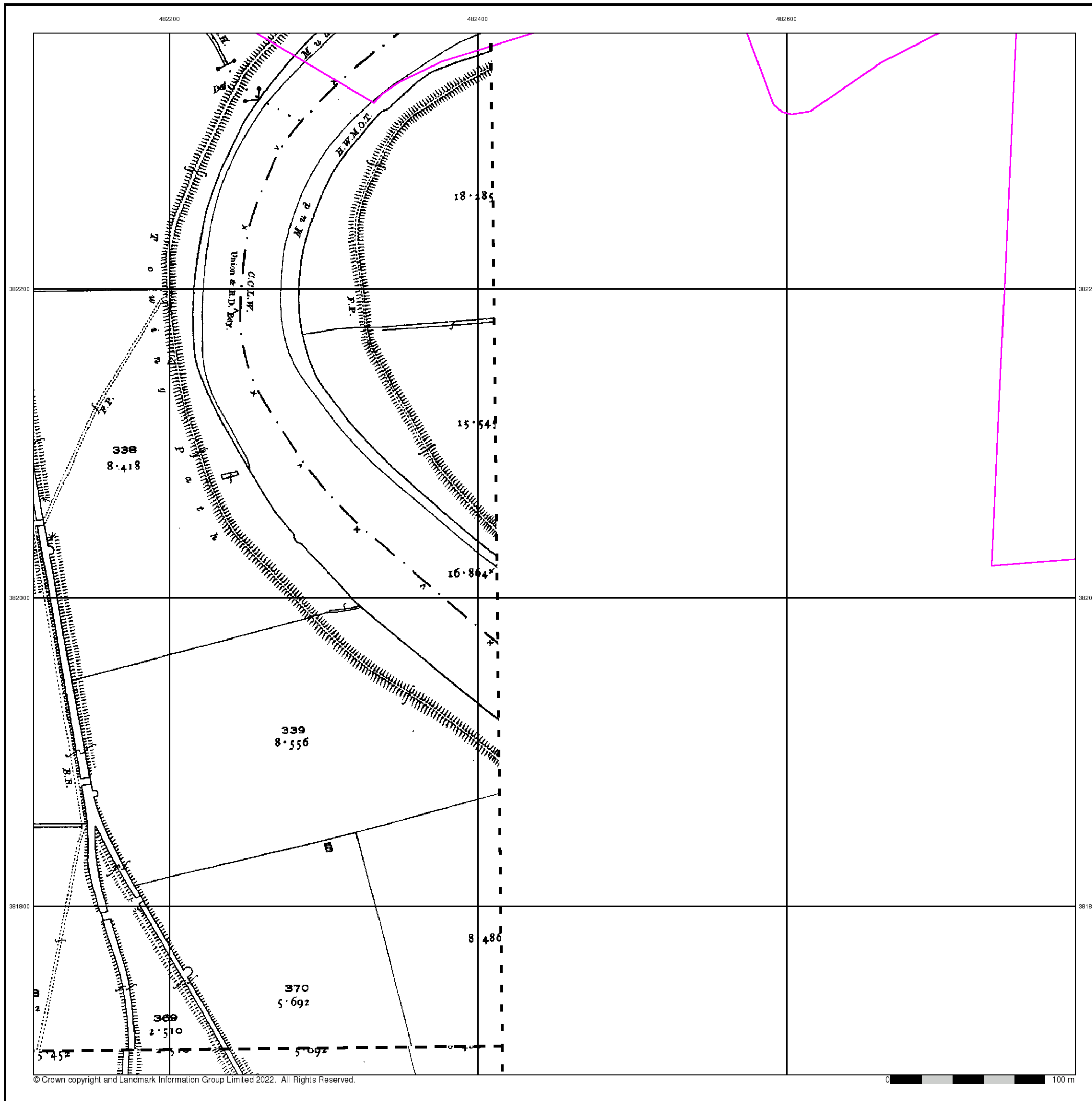

Lincolnshire

Published 1920

Source map scale - 1:2,500

The historical maps shown were reproduced from maps predominantly held at the scale adopted for England, Wales and Scotland in the 1840's. In 1854 the 1:2,500 scale was adopted for mapping urban areas and by 1896 it covered the whole of what were considered to be the cultivated parts of Great Britain. The published date given below is often some years later than the surveyed date. Before 1938, all OS maps were based on the Cassini Projection, with independent surveys of a single county or group of counties, giving rise to significant inaccuracies in outlying areas.

Map Name(s) and Date(s)

050_12 1920 1:2,500	051_09 1920 1:2,500
1	
051_13 1920 1:2,500	

Historical Map - Segment B14

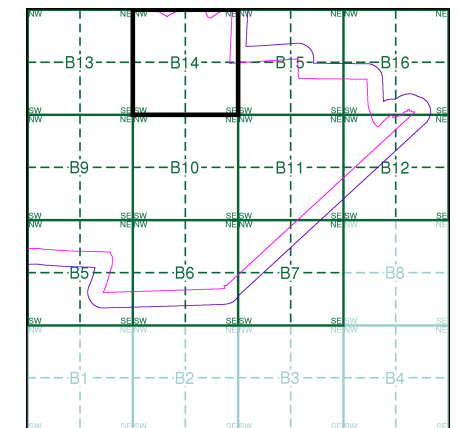

Order Details

Order Number: 298001706_1_1
 Customer Ref: 21-2098.04
 National Grid Reference: 482570, 381420
 Slice: B
 Site Area (Ha): 1355.61
 Search Buffer (m): 100

Site Details

West Barton 2

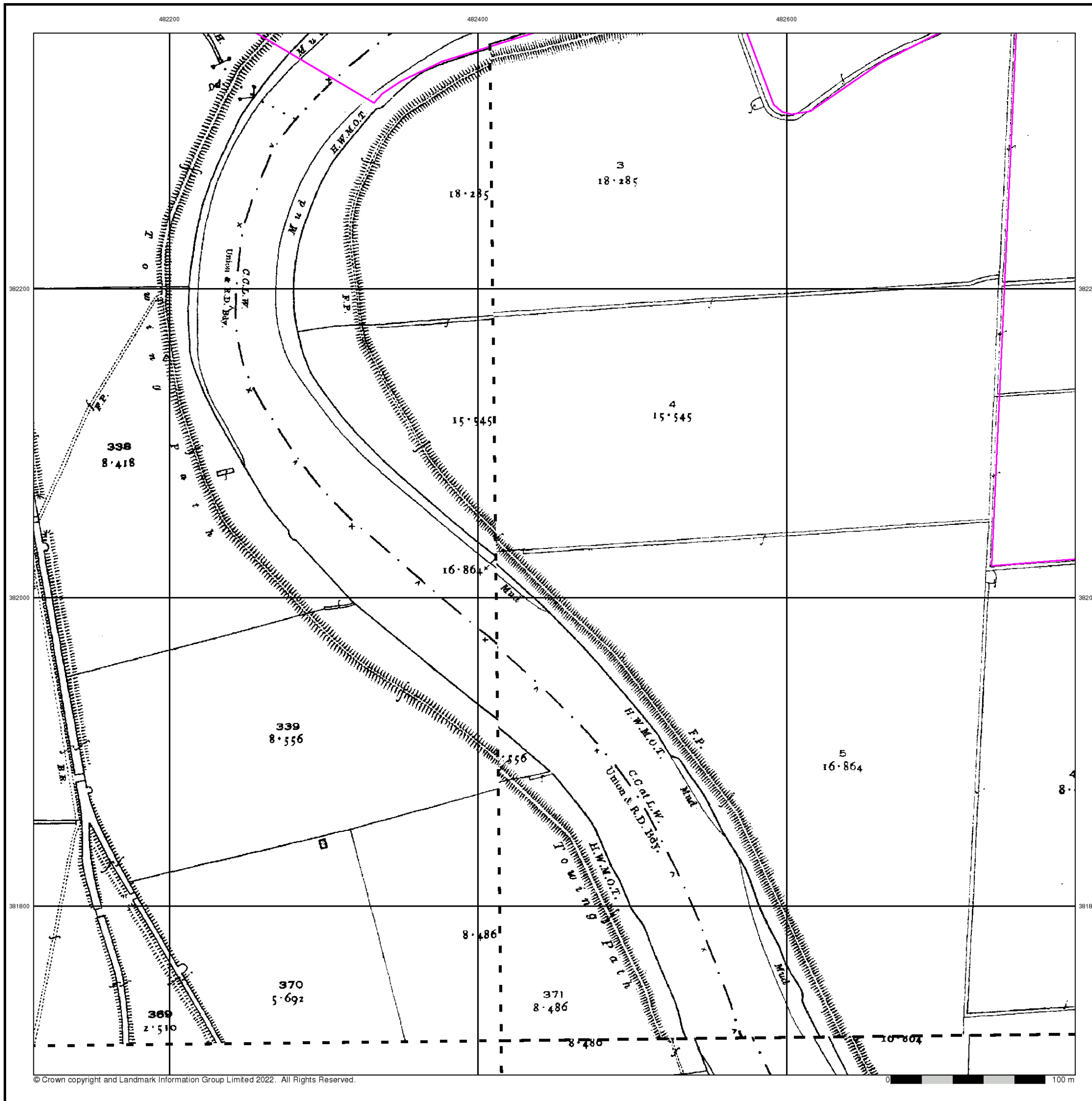

Ordnance Survey Plan

Published 1975

Source map scale - 1:2,500

The historical maps shown were reproduced from maps predominantly held at the scale adopted for England, Wales and Scotland in the 1840's. In 1854 the 1:2,500 scale was adopted for mapping urban areas and by 1896 it covered the whole of what were considered to be the cultivated parts of Great Britain. The published date given below is often some years later than the surveyed date. Before 1938, all OS maps were based on the Cassini Projection, with independent surveys of a single county or group of counties, giving rise to significant inaccuracies in outlying areas.

Map Name(s) and Date(s)

SK8282	1975	1:2,500
SK8281	1975	1:2,500

Historical Map - Segment B14

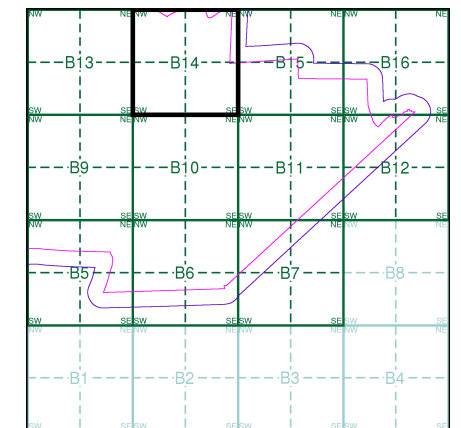

Order Details

Order Number: 298001706_1_1
 Customer Ref: 21-2098.04
 National Grid Reference: 482570, 381420
 Slice: B
 Site Area (Ha): 1355.61
 Search Buffer (m): 100

Site Details

West Barton 2

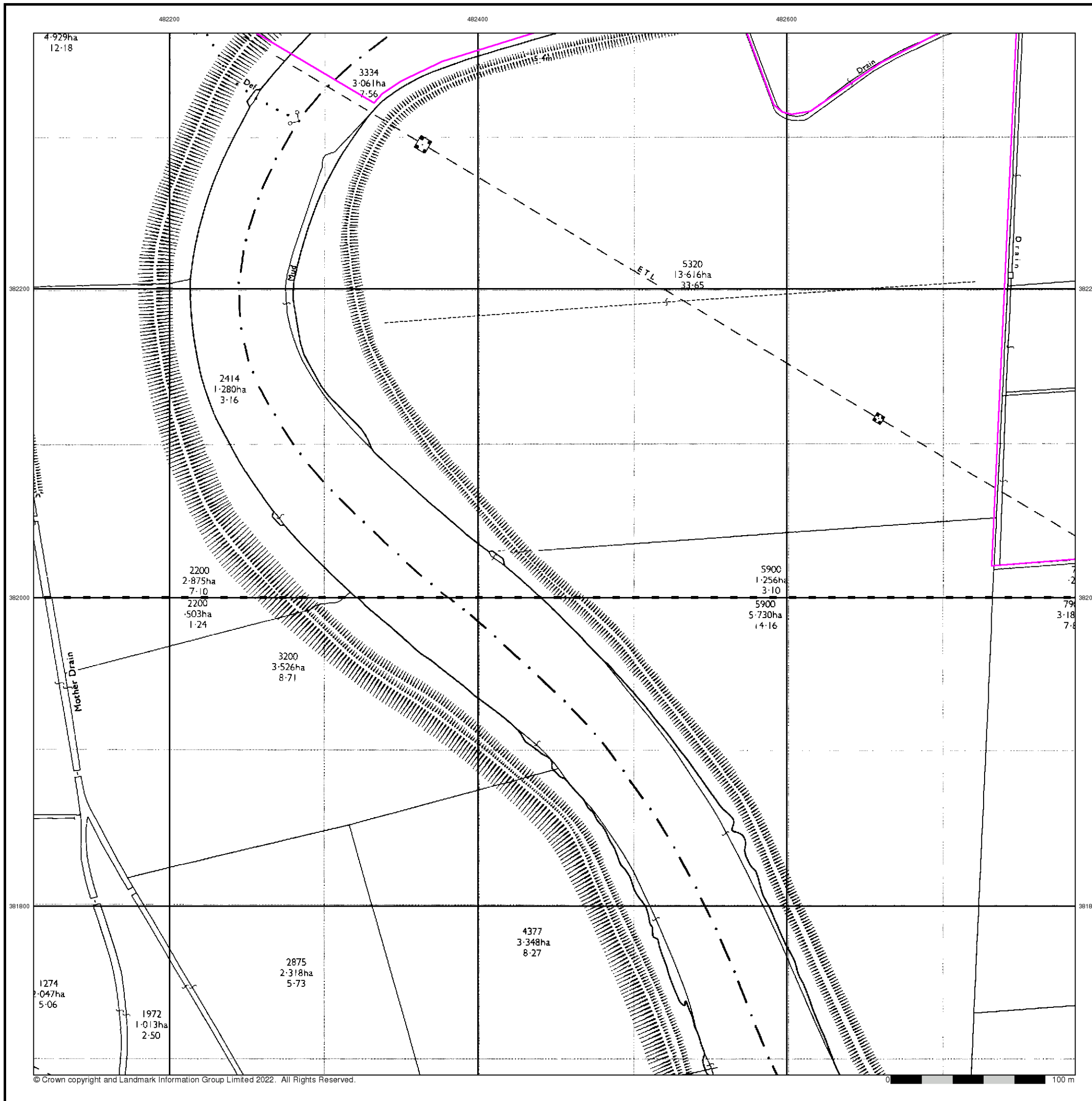

Large-Scale National Grid Data

Published 1994

Source map scale - 1:2,500

'Large Scale National Grid Data' superseded SIM cards (Ordnance Survey's 'Survey of Information on Microfilm') in 1992, and continued to be produced until 1999. These maps were the fore-runners of digital mapping and so provide detailed information on houses and roads, but tend to show less topographic features such as vegetation. These maps were produced at both 1:2,500 and 1:1,250 scales.

Map Name(s) and Date(s)

SK8282	1994	1:2,500
SK8281	1994	1:2,500

Historical Map - Segment B14

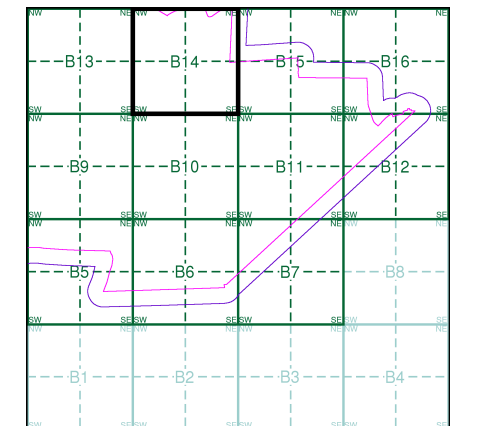

Order Details

Order Number: 298001706_1_1
 Customer Ref: 21-2098.04
 National Grid Reference: 482570, 381420
 Slice: B
 Site Area (Ha): 1355.61
 Search Buffer (m): 100

Site Details

West Barton 2



Historical Mapping Legends

Ordnance Survey County Series and Ordnance Survey Plan 1:2,500

Quarry **Gravel Pit** **Sand Pit**
Clay Pit **Shingle** **Refuse Heap**
Sloping Masonry **Flat Rock**
Marsh **Reeds** **Osiers**
Rough Pasture **Furze** **Wood**
Mixed Wood **Brushwood** **Orchard**
Fir **Ford** **Stepping Stones**
Ferry **Waterfall** **Lock**
Trig. Station **Altitude at Trig. Station**
B.M. 325.9 **Bench Mark** **Surface Level**
Arrow denotes flow of water **Antiquities (site of)**
Cutting **Embankment**
Railway crossing Road **Level Crossing** **Road crossing Railway**
Railway crossing River or Canal **Road over single stream** **Road over River or Canal**
County Boundary (Geographical)
County & Civil Parish Boundary
Administrative County & Civil Parish Boundary
County Borough Boundary (England)
Co. Boro. Bdy.
County Burgh Boundary (Scotland)
Boundary Post or Stone **Police Call Box**
B.R. **Bridle Road** **P** **Pump**
E.P. **Electricity Pylon** **S.P.** **Signal Post**
F.B. **Foot Bridge** **Sl.** **Sluice**
F.P. **Foot Path** **Sp.** **Spring**
G.P. **Guide Post or Board** **T.C.B.** **Telephone Call Box**
M.S. **Mile Stone** **Tr.** **Trough**
M.P. M.R. **Mooring Post or Ring** **W** **Well**

Ordnance Survey Plan, Additional SIMs and Supply of Unpublished Survey Information 1:2,500 and 1:1,250

Inactive Quarry, Chalk Pit or Clay Pit **Active Quarry, Chalk Pit or Clay Pit**
Rock **Boulders**
Cliff **Slopes** **Top**
Roofed Building **Glazed Roof Building**
Sloping Masonry **Archway**
Non-Coniferous Tree (surveyed) **Coniferous Tree (surveyed)**
Non-Coniferous Trees (not surveyed) **Coniferous Trees (not surveyed)**
Orchard Tree **Scrub** **Bracken**
Coppice, Osier **Reeds** **Marsh, Saltings**
Rough Grassland **Heath** **Culvert**
Direction of water flow **Bench Mark** **Antiquity (site of)**
Cave Entrance **Triangulation Station** **Electricity Pylon**
Electricity Transmission Line
County Boundary (Geographical)
County & Civil Parish Boundary
Civil Parish Boundary
Admin. County or County Bor. Boundary
London Borough Boundary
Symbol marking point where boundary mereing changes
Beer House **Pillar, Pole or Post**
Boundary Post or Stone **Post Office**
Capstan, Crane **Public Convenience**
Chimney **Public House**
Drinking Fountain **Pump**
Electricity Pillar or Post **Signal Box or Bridge**
Fire Alarm Pillar **Signal Post or Light**
Foot Bridge **Spring**
Guide Post **Tank or Track**
Hydrant or Hydraulic **Telephone Call Box**
Level Crossing **Telephone Call Post**
Manhole **Trough**
Mile Post or Mooring Post **Water Point, Water Tap**
Mile Stone **Well**
Normal Tidal Limit **Wind Pump**

Large-Scale National Grid Data 1:2,500 and 1:1,250

Cliff **Slopes** **Top**
Rock **Rock (scattered)**
Boulders **Boulders (scattered)**
Positioned Boulder **Scree**
Non-Coniferous Tree (surveyed) **Coniferous Tree (surveyed)**
Non-Coniferous Trees (not surveyed) **Coniferous Trees (not surveyed)**
Orchard Tree **Scrub** **Bracken**
Coppice, Osier **Reeds** **Marsh, Saltings**
Rough Grassland **Heath** **Culvert**
Direction of water flow **Triangulation Station** **Antiquity (site of)**
Electricity Transmission Line **Electricity Pylon**
Bench Mark **Buildings with Building Seed**
Roofed Building **Glazed Roof Building**
Civil parish/community boundary
District boundary
County boundary
Boundary post/stone
Boundary mereing symbol (note: these always appear in opposed pairs or groups of three)
Barracks **Pillar, Pole or Post**
Battery **Post Office**
Cemetery **Public Convenience**
Chimney **Pump**
Cistern **Pumping Station**
Dismtd Rly **Dismantled Railway** **PW** **Place of Worship**
Electricity Generating Station **Sewage Ppg Sta** **Sewage Pumping Station**
Electricity Pole, Pillar **Signal Box or Bridge**
Electricity Sub Station **Signal Post or Light**
Filter Bed **Spring**
Fountain / Drinking Ftn. **Tank or Track**
Gas Valve Compound **Trough**
Gas Governor **Wind Pump**
Guide Post **Water Point, Water Tap**
Manhole **Works (building or area)**
Mile Post or Mile Stone **Well**



Historical Mapping & Photography included:

Mapping Type	Scale	Date	Pg
Lincolnshire	1:2,500	1886	2
Nottinghamshire	1:2,500	1899	3
Lincolnshire	1:2,500	1920	4
Ordnance Survey Plan	1:2,500	1975	5
Large-Scale National Grid Data	1:2,500	1994	6

Historical Map - Segment B15

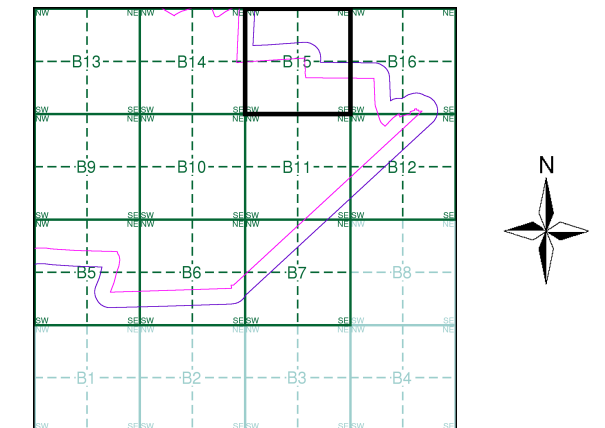

Order Details

Order Number: 298001706_1_1
 Customer Ref: 21-2098.04
 National Grid Reference: 482570, 381420
 Slice: B
 Site Area (Ha): 1355.61
 Search Buffer (m): 100

Site Details

West Barton 2



Tel: 0844 844 9952
 Fax: 0844 844 9951
 Web: [REDACTED]

Lincolnshire
Published 1886

Source map scale - 1:2,500

The historical maps shown were reproduced from maps predominantly held at the scale adopted for England, Wales and Scotland in the 1840's. In 1854 the 1:2,500 scale was adopted for mapping urban areas and by 1896 it covered the whole of what were considered to be the cultivated parts of Great Britain. The published date given below is often some years later than the surveyed date. Before 1938, all OS maps were based on the Cassini Projection, with independent surveys of a single county or group of counties, giving rise to significant inaccuracies in outlying areas.

Map Name(s) and Date(s)

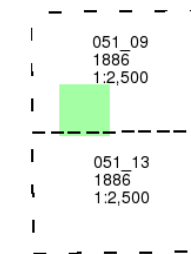

Historical Map - Segment B15

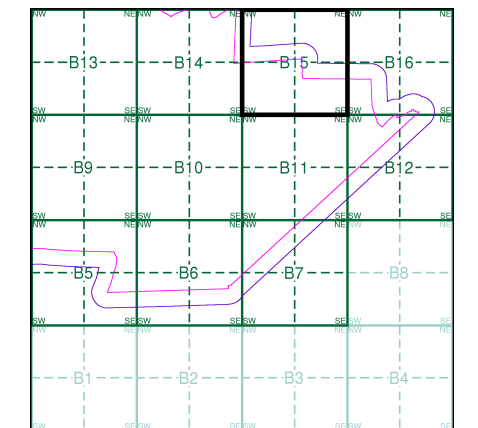

Order Details

Order Number: 298001706_1_1
 Customer Ref: 21-2098.04
 National Grid Reference: 482570, 381420
 Slice: B
 Site Area (Ha): 1355.61
 Search Buffer (m): 100

Site Details

West Barton 2

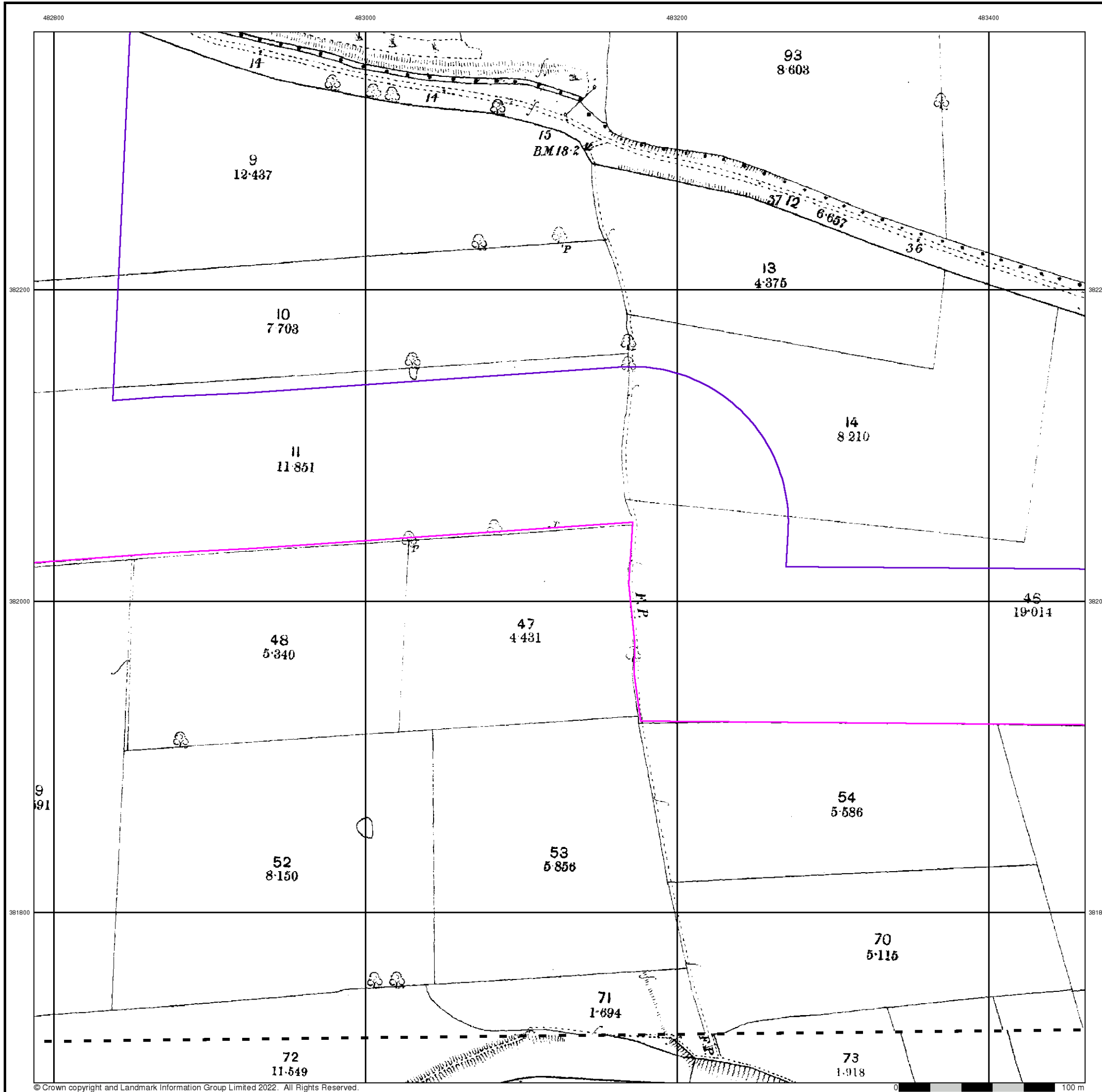

482600

483000

483200

483400

382200

382200

382000

382000

9
91

381800

Nottinghamshire

Published 1899

Source map scale - 1:2,500

The historical maps shown were reproduced from maps predominantly held at the scale adopted for England, Wales and Scotland in the 1840's. In 1854 the 1:2,500 scale was adopted for mapping urban areas and by 1896 it covered the whole of what were considered to be the cultivated parts of Great Britain. The published date given below is often some years later than the surveyed date. Before 1938, all OS maps were based on the Cassini Projection, with independent surveys of a single county or group of counties, giving rise to significant inaccuracies in outlying areas.

Map Name(s) and Date(s)

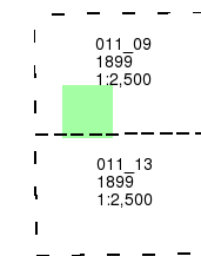

Historical Map - Segment B15

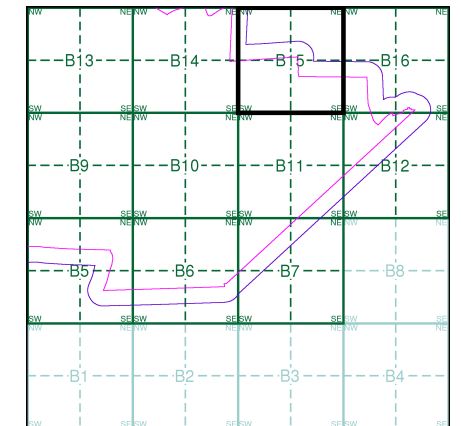

Order Details

Order Number: 298001706_1_1
 Customer Ref: 21-2098.04
 National Grid Reference: 482570, 381420
 Slice: B
 Site Area (Ha): 1355.61
 Search Buffer (m): 100

Site Details

West Barton 2

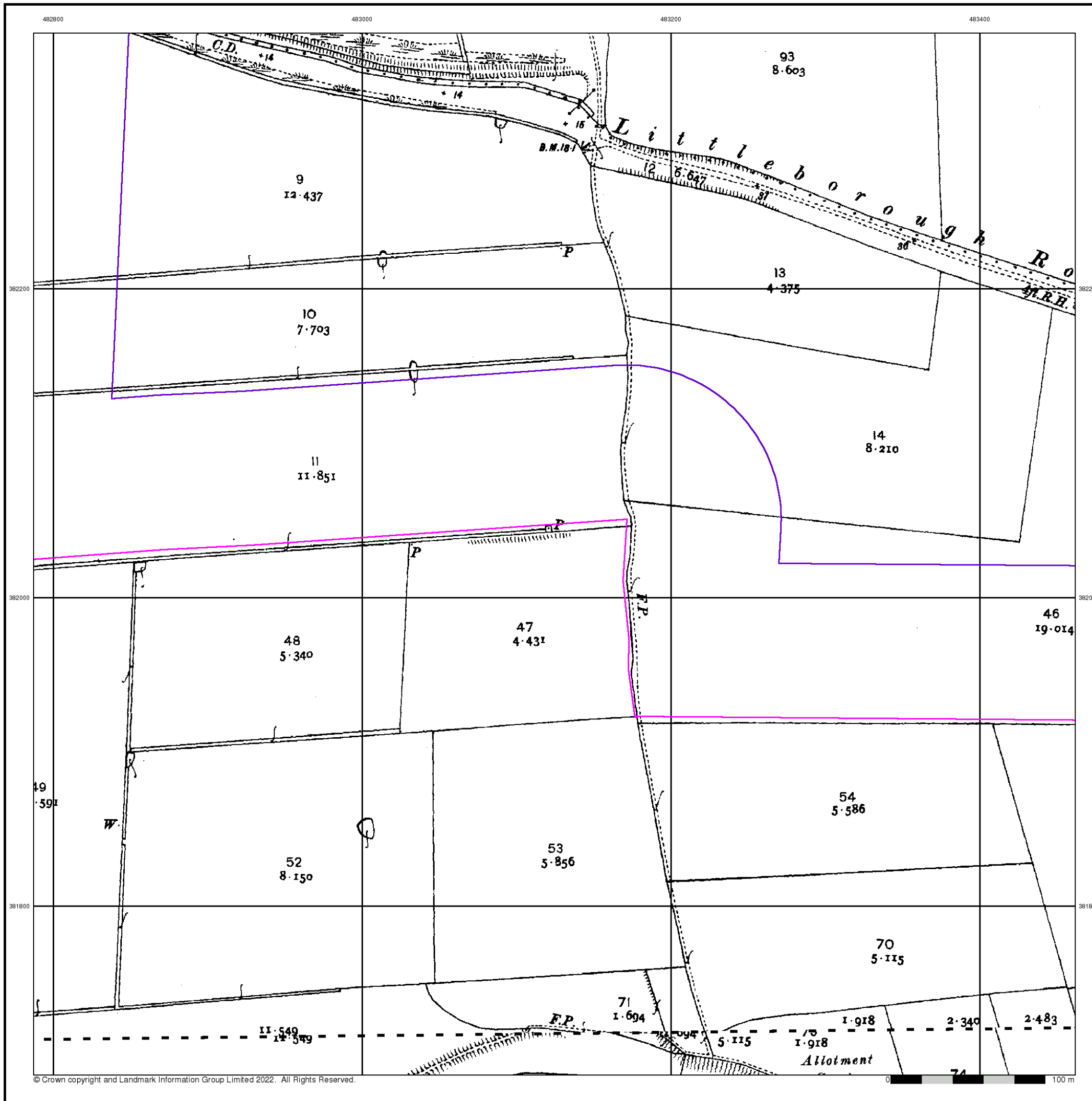



Lincolnshire

Published 1920

Source map scale - 1:2,500

The historical maps shown were reproduced from maps predominantly held at the scale adopted for England, Wales and Scotland in the 1840's. In 1854 the 1:2,500 scale was adopted for mapping urban areas and by 1896 it covered the whole of what were considered to be the cultivated parts of Great Britain. The published date given below is often some years later than the surveyed date. Before 1938, all OS maps were based on the Cassini Projection, with independent surveys of a single county or group of counties, giving rise to significant inaccuracies in outlying areas.

Map Name(s) and Date(s)

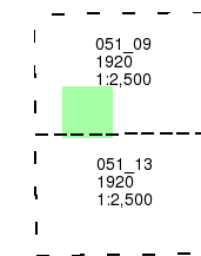

Historical Map - Segment B15

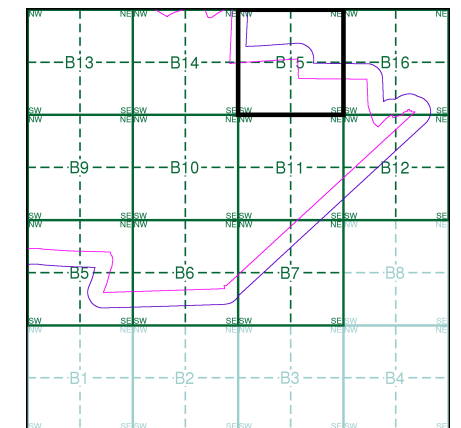

Order Details

Order Number: 298001706_1_1
Customer Ref: 21-2098.04
National Grid Reference: 482570, 381420
Slice: B
Site Area (Ha): 1355.61
Search Buffer (m): 100

Site Details

West Barton 2



Tel: 0844 844 9952
Fax: 0844 844 9951
Web: [REDACTED]



Ordnance Survey Plan

Published 1975

Source map scale - 1:2,500

The historical maps shown were reproduced from maps predominantly held at the scale adopted for England, Wales and Scotland in the 1840's. In 1854 the 1:2,500 scale was adopted for mapping urban areas and by 1896 it covered the whole of what were considered to be the cultivated parts of Great Britain. The published date given below is often some years later than the surveyed date. Before 1938, all OS maps were based on the Cassini Projection, with independent surveys of a single county or group of counties, giving rise to significant inaccuracies in outlying areas.

Map Name(s) and Date(s)

SK8282 1975 12,500	SK8382 1975 12,500
SK8281 1975 12,500	SK8381 1975 12,500

Historical Map - Segment B15

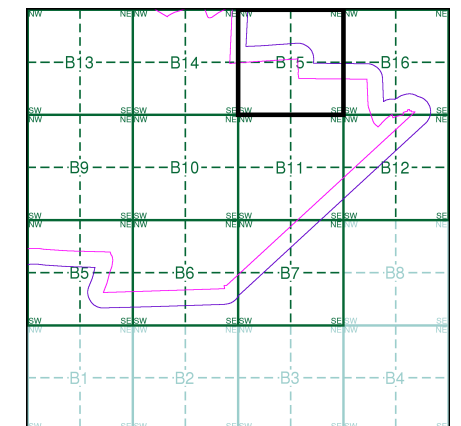

Order Details

Order Number: 298001706_1_1
 Customer Ref: 21-2098.04
 National Grid Reference: 482570, 381420
 Slice: B
 Site Area (Ha): 1355.61
 Search Buffer (m): 100

Site Details

West Barton 2

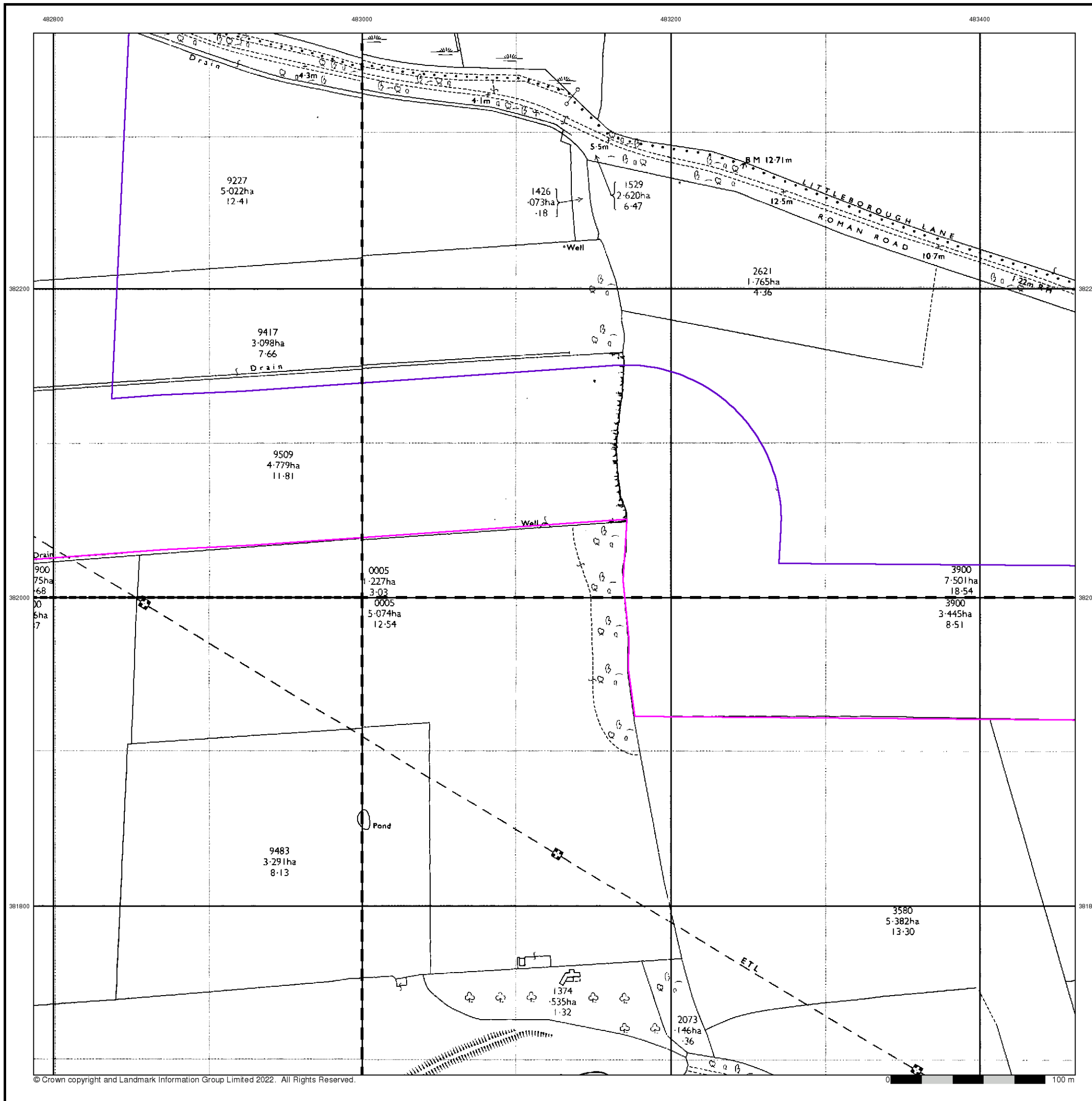

Large-Scale National Grid Data

Published 1994

Source map scale - 1:2,500

'Large Scale National Grid Data' superseded SIM cards (Ordnance Survey's 'Survey of Information on Microfilm') in 1992, and continued to be produced until 1999. These maps were the fore-runners of digital mapping and so provide detailed information on houses and roads, but tend to show less topographic features such as vegetation. These maps were produced at both 1:2,500 and 1:1,250 scales.

Map Name(s) and Date(s)

SK8282	SK8382
1994	1994
12,500	12,500
SK8281	SK8381
1994	1994
12,500	12,500

Historical Map - Segment B15

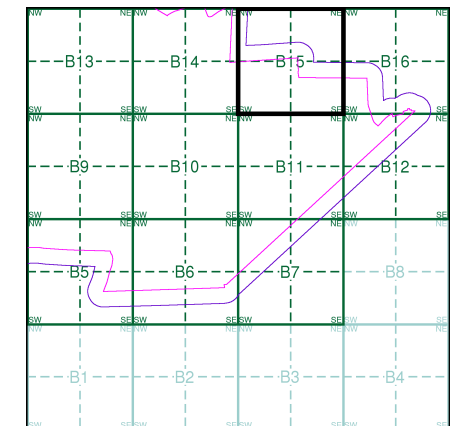

Order Details

Order Number: 298001706_1_1
 Customer Ref: 21-2098.04
 National Grid Reference: 482570, 381420
 Slice: B
 Site Area (Ha): 1355.61
 Search Buffer (m): 100

Site Details

West Barton 2

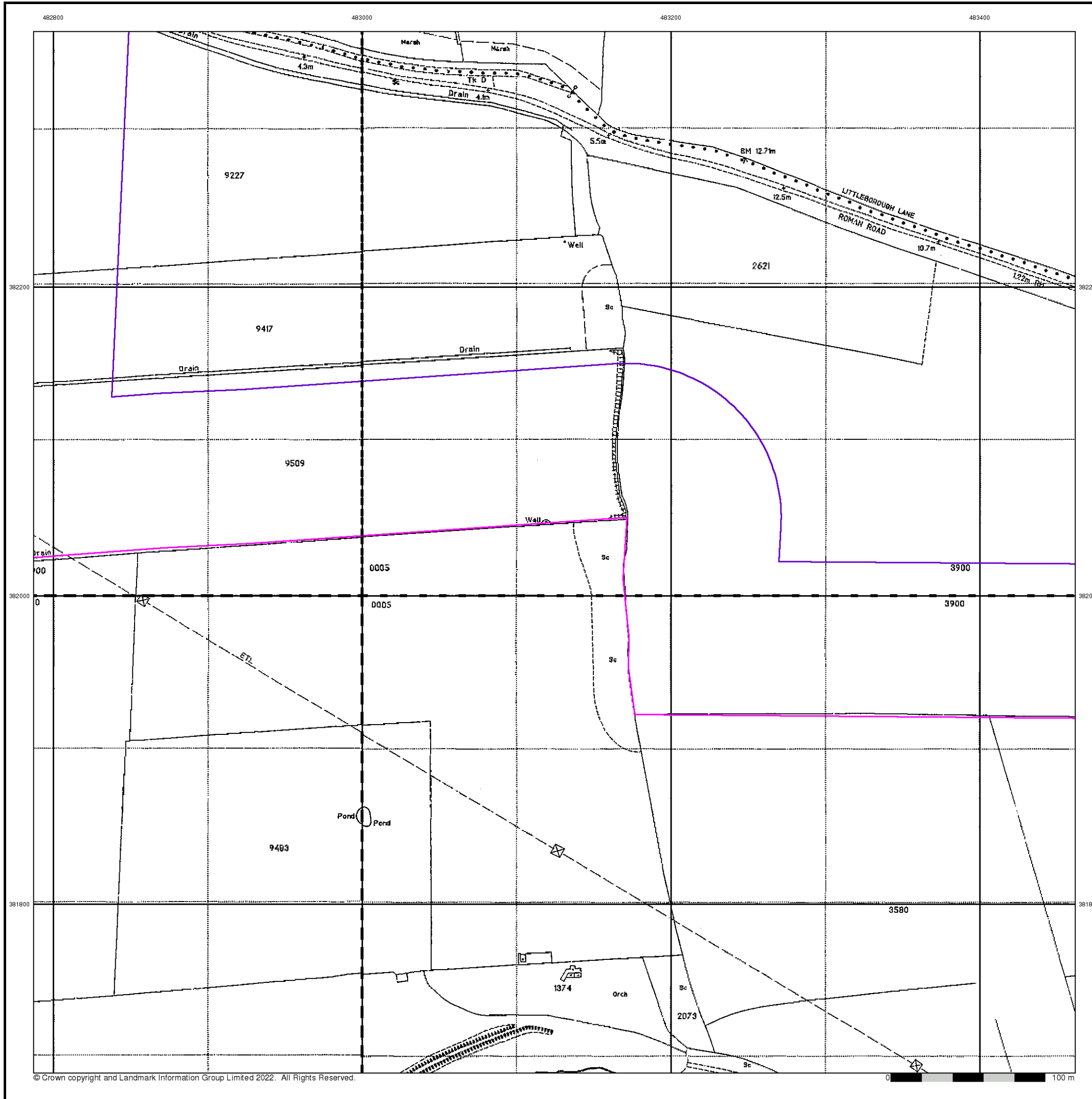

Historical Mapping Legends

Ordnance Survey County Series and Ordnance Survey Plan 1:2,500

Quarry **Gravel Pit** **Sand Pit**
Clay Pit **Shingle** **Refuse Heap**
Sloping Masonry **Flat Rock**
Marsh **Reeds** **Osiers**
Rough Pasture **Furze** **Wood**
Mixed Wood **Brushwood** **Orchard**
Fir **Ford** **Stepping Stones**
Ferry **Waterfall** **Lock**
Trig. Station **Altitude at Trig. Station**
B.M. 325.9 **Bench Mark** **Surface Level**
Arrow denotes flow of water **Antiquities (site of)**
Cutting **Embankment**
Railway crossing Road **Level Crossing** **Road crossing Railway**
Railway crossing River or Canal **Road over single stream** **Road over River or Canal**
County Boundary (Geographical)
County & Civil Parish Boundary
Administrative County & Civil Parish Boundary
County Borough Boundary (England)
Co. Boro. Bdy.
County Burgh Boundary (Scotland)
Boundary Post or Stone **Police Call Box**
B.R. **Bridle Road** **P** **Pump**
E.P **Electricity Pylon** **S.P** **Signal Post**
F.B. **Foot Bridge** **Sl** **Sluice**
F.P. **Foot Path** **Sp.** **Spring**
G.P **Guide Post or Board** **T.C.B** **Telephone Call Box**
M.S **Mile Stone** **Tr.** **Trough**
M.P M.R **Mooring Post or Ring** **W** **Well**

Ordnance Survey Plan, Additional SIMs and Supply of Unpublished Survey Information 1:2,500 and 1:1,250

Inactive Quarry, Chalk Pit or Clay Pit **Active Quarry, Chalk Pit or Clay Pit**
Rock **Boulders**
Cliff **Slopes** **Top**
Roofed Building **Glazed Roof Building**
Sloping Masonry **Archway**
Non-Coniferous Tree (surveyed) **Coniferous Tree (surveyed)**
Non-Coniferous Trees (not surveyed) **Coniferous Trees (not surveyed)**
Orchard Tree **Scrub** **Bracken**
Coppice, Osier **Reeds** **Marsh, Saltings**
Rough Grassland **Heath** **Culvert**
Direction of water flow **Bench Mark** **Antiquity (site of)**
Cave Entrance **Triangulation Station** **Electricity Pylon**
Electricity Transmission Line
County Boundary (Geographical)
County & Civil Parish Boundary
Civil Parish Boundary
Admin. County or County Bor. Boundary
London Borough Boundary
Symbol marking point where boundary mereing changes
Beer House **Pillar, Pole or Post**
Boundary Post or Stone **Post Office**
Capstan, Crane **Public Convenience**
Chimney **Public House**
Drinking Fountain **Pump**
Electricity Pillar or Post **Signal Box or Bridge**
Fire Alarm Pillar **Signal Post or Light**
Foot Bridge **Spring**
Guide Post **Tank or Track**
Hydrant or Hydraulic **Telephone Call Box**
Level Crossing **Telephone Call Post**
Manhole **Trough**
Mile Post or Mooring Post **Water Point, Water Tap**
Mile Stone **Well**
Normal Tidal Limit **Wind Pump**

Large-Scale National Grid Data 1:2,500 and 1:1,250

Cliff **Slopes** **Top**
Rock **Rock (scattered)**
Boulders **Boulders (scattered)**
Positioned Boulder **Scree**
Non-Coniferous Tree (surveyed) **Coniferous Tree (surveyed)**
Non-Coniferous Trees (not surveyed) **Coniferous Trees (not surveyed)**
Orchard Tree **Scrub** **Bracken**
Coppice, Osier **Reeds** **Marsh, Saltings**
Rough Grassland **Heath** **Culvert**
Direction of water flow **Triangulation Station** **Antiquity (site of)**
Electricity Transmission Line **Electricity Pylon**
Bench Mark **Buildings with Building Seed**
Roofed Building **Glazed Roof Building**
Civil parish/community boundary
District boundary
County boundary
Boundary post/stone
Boundary mereing symbol (note: these always appear in opposed pairs or groups of three)
Barracks **Pillar, Pole or Post**
Battery **Post Office**
Cemetery **Public Convenience**
Chimney **Pump**
Cistern **Pumping Station**
Dismtd Rly **Place of Worship**
Electricity Generating Station **Sewage Ppg Sta** **Sewage Pumping Station**
Electricity Pole, Pillar **Signal Box or Bridge**
Electricity Sub Station **Signal Post or Light**
Filter Bed **Spring**
Fountain / Drinking Ftn. **Tank or Track**
Gas Valve Compound **Trough**
Gas Governor **Wind Pump**
Guide Post **Water Point, Water Tap**
Manhole **Works (building or area)**
Mile Post or Mile Stone **Well**

Historical Mapping & Photography included:

Mapping Type	Scale	Date	Pg
Lincolnshire	1:2,500	1886	2
Nottinghamshire	1:2,500	1899	3
Lincolnshire	1:2,500	1920	4
Ordnance Survey Plan	1:2,500	1974 - 1975	5
Additional SIMs	1:2,500	1993	6
Large-Scale National Grid Data	1:2,500	1994	7

Historical Map - Segment B16

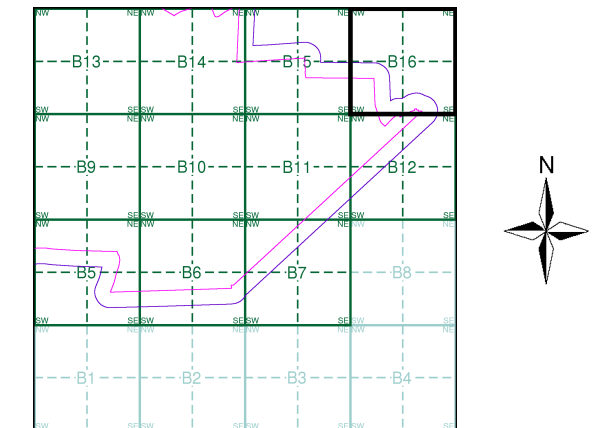

Order Details

Order Number: 298001706_1_1
 Customer Ref: 21-2098.04
 National Grid Reference: 482570, 381420
 Slice: B
 Site Area (Ha): 1355.61
 Search Buffer (m): 100

Site Details

West Barton 2

Lincolnshire

Published 1886

Source map scale - 1:2,500

The historical maps shown were reproduced from maps predominantly held at the scale adopted for England, Wales and Scotland in the 1840's. In 1854 the 1:2,500 scale was adopted for mapping urban areas and by 1896 it covered the whole of what were considered to be the cultivated parts of Great Britain. The published date given below is often some years later than the surveyed date. Before 1938, all OS maps were based on the Cassini Projection, with independent surveys of a single county or group of counties, giving rise to significant inaccuracies in outlying areas.

Map Name(s) and Date(s)

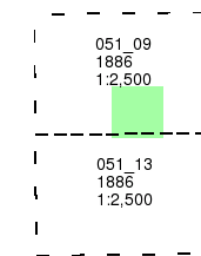

Historical Map - Segment B16

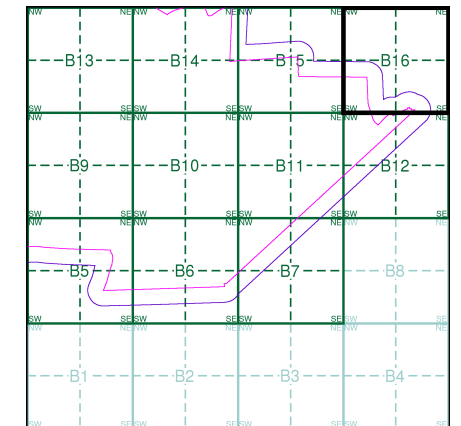

Order Details

Order Number: 298001706_1_1
 Customer Ref: 21-2098.04
 National Grid Reference: 482570, 381420
 Slice: B
 Site Area (Ha): 1355.61
 Search Buffer (m): 100

Site Details

West Barton 2

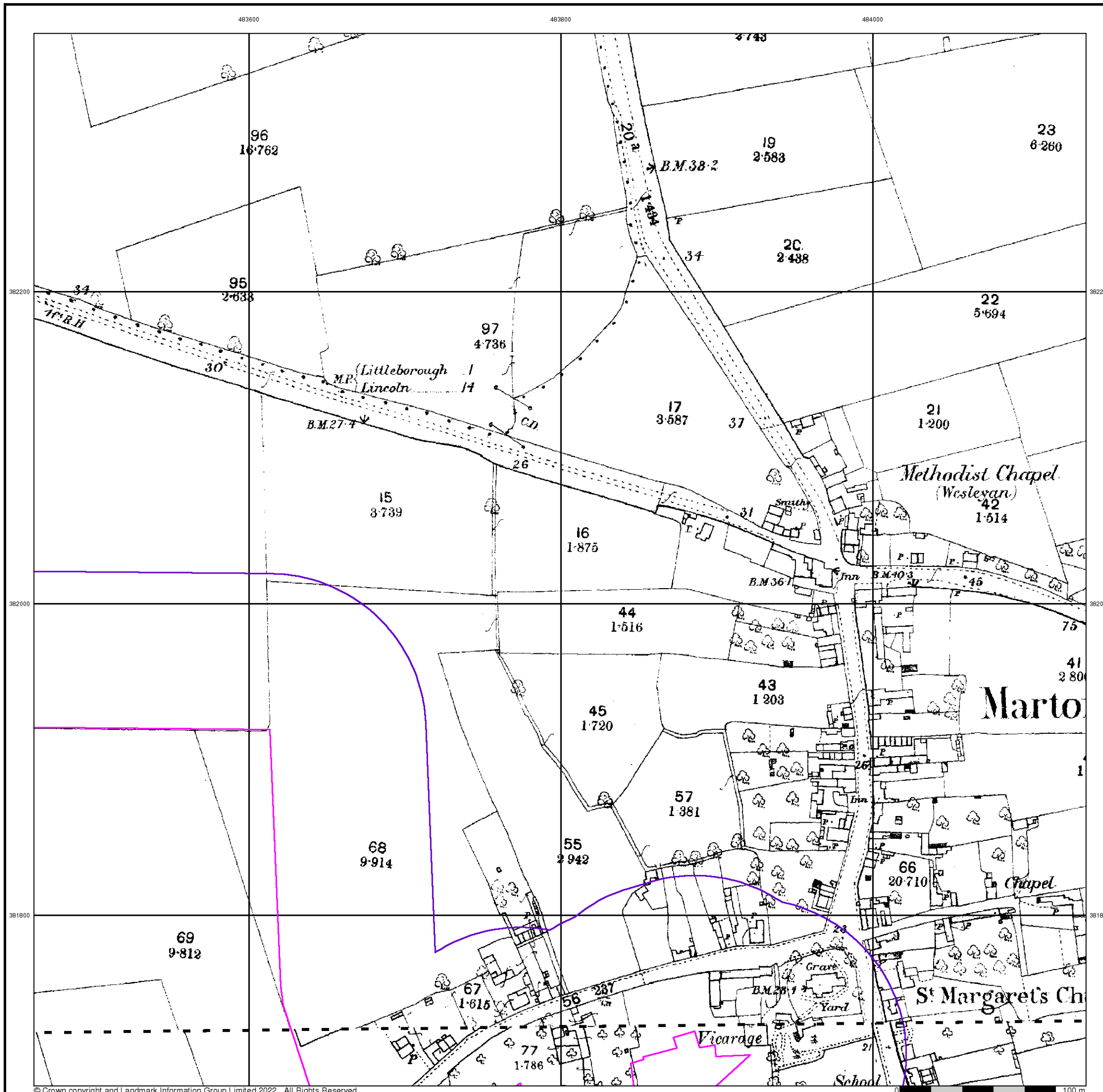

Nottinghamshire

Published 1899

Source map scale - 1:2,500

The historical maps shown were reproduced from maps predominantly held at the scale adopted for England, Wales and Scotland in the 1840's. In 1854 the 1:2,500 scale was adopted for mapping urban areas and by 1896 it covered the whole of what were considered to be the cultivated parts of Great Britain. The published date given below is often some years later than the surveyed date. Before 1938, all OS maps were based on the Cassini Projection, with independent surveys of a single county or group of counties, giving rise to significant inaccuracies in outlying areas.

Map Name(s) and Date(s)

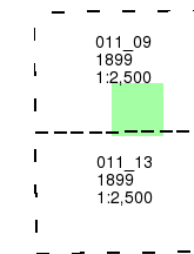

Historical Map - Segment B16

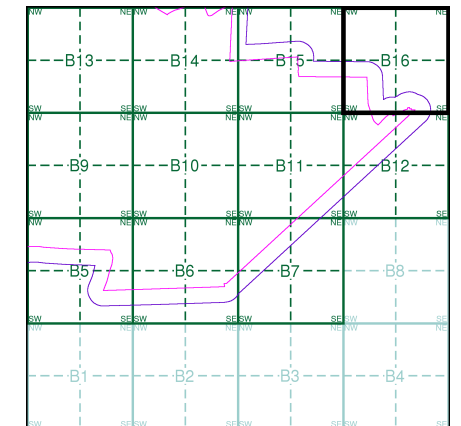

Order Details

Order Number: 298001706_1_1
 Customer Ref: 21-2098.04
 National Grid Reference: 482570, 381420
 Slice: B
 Site Area (Ha): 1355.61
 Search Buffer (m): 100

Site Details

West Barton 2

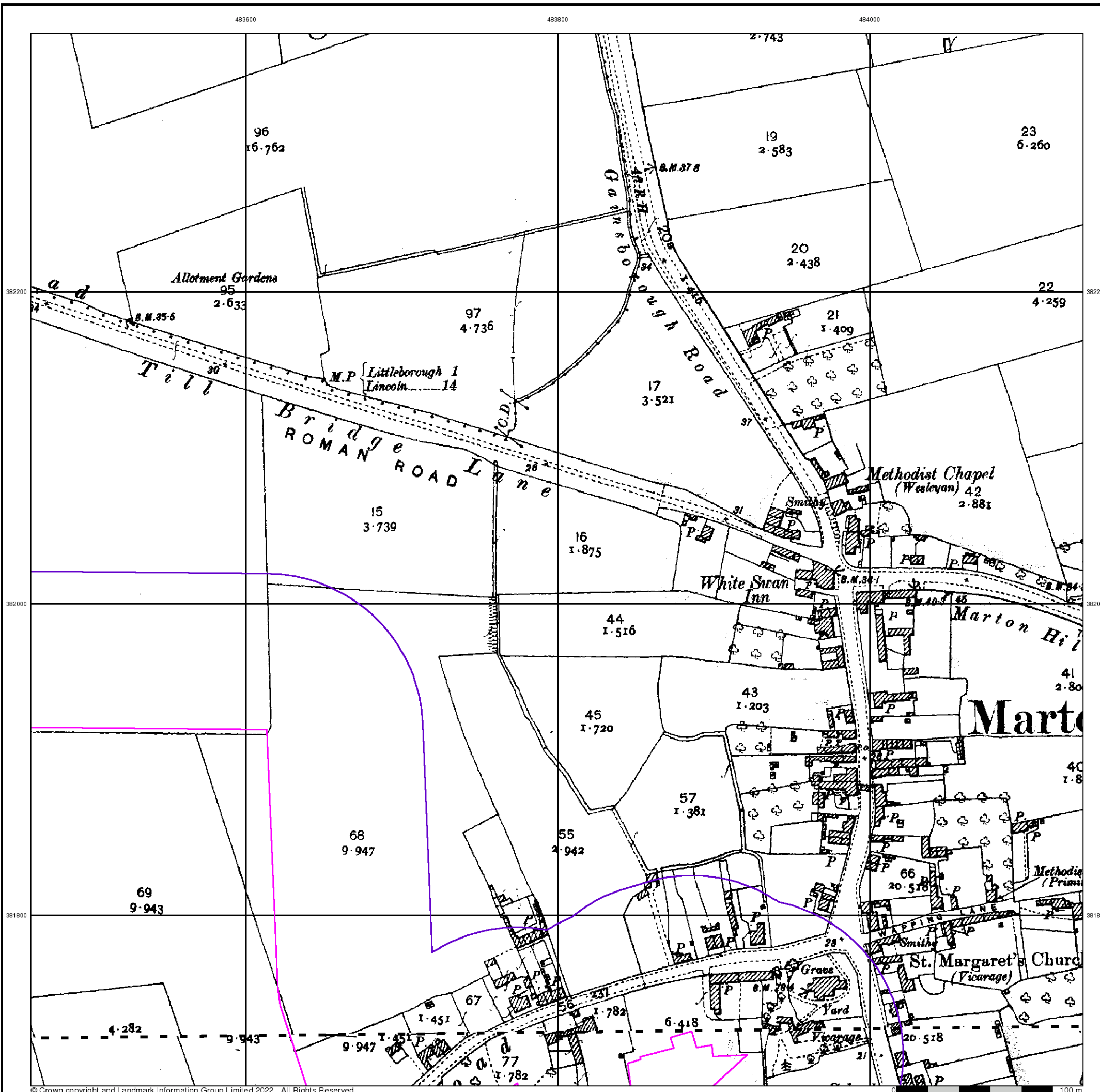

Lincolnshire

Published 1920

Source map scale - 1:2,500

The historical maps shown were reproduced from maps predominantly held at the scale adopted for England, Wales and Scotland in the 1840's. In 1854 the 1:2,500 scale was adopted for mapping urban areas and by 1896 it covered the whole of what were considered to be the cultivated parts of Great Britain. The published date given below is often some years later than the surveyed date. Before 1938, all OS maps were based on the Cassini Projection, with independent surveys of a single county or group of counties, giving rise to significant inaccuracies in outlying areas.

Map Name(s) and Date(s)

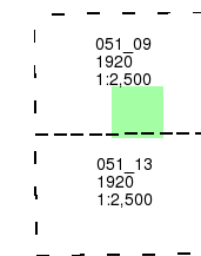

Historical Map - Segment B16

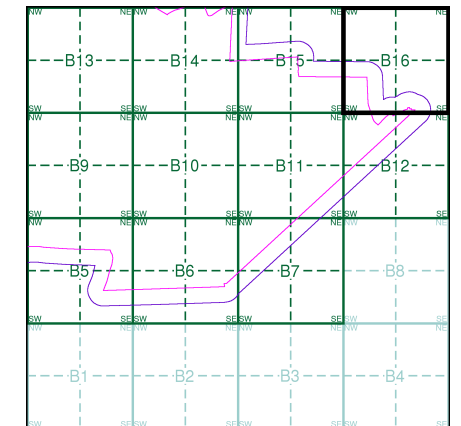

Order Details

Order Number: 298001706_1_1
 Customer Ref: 21-2098.04
 National Grid Reference: 482570, 381420
 Slice: B
 Site Area (Ha): 1355.61
 Search Buffer (m): 100

Site Details

West Barton 2

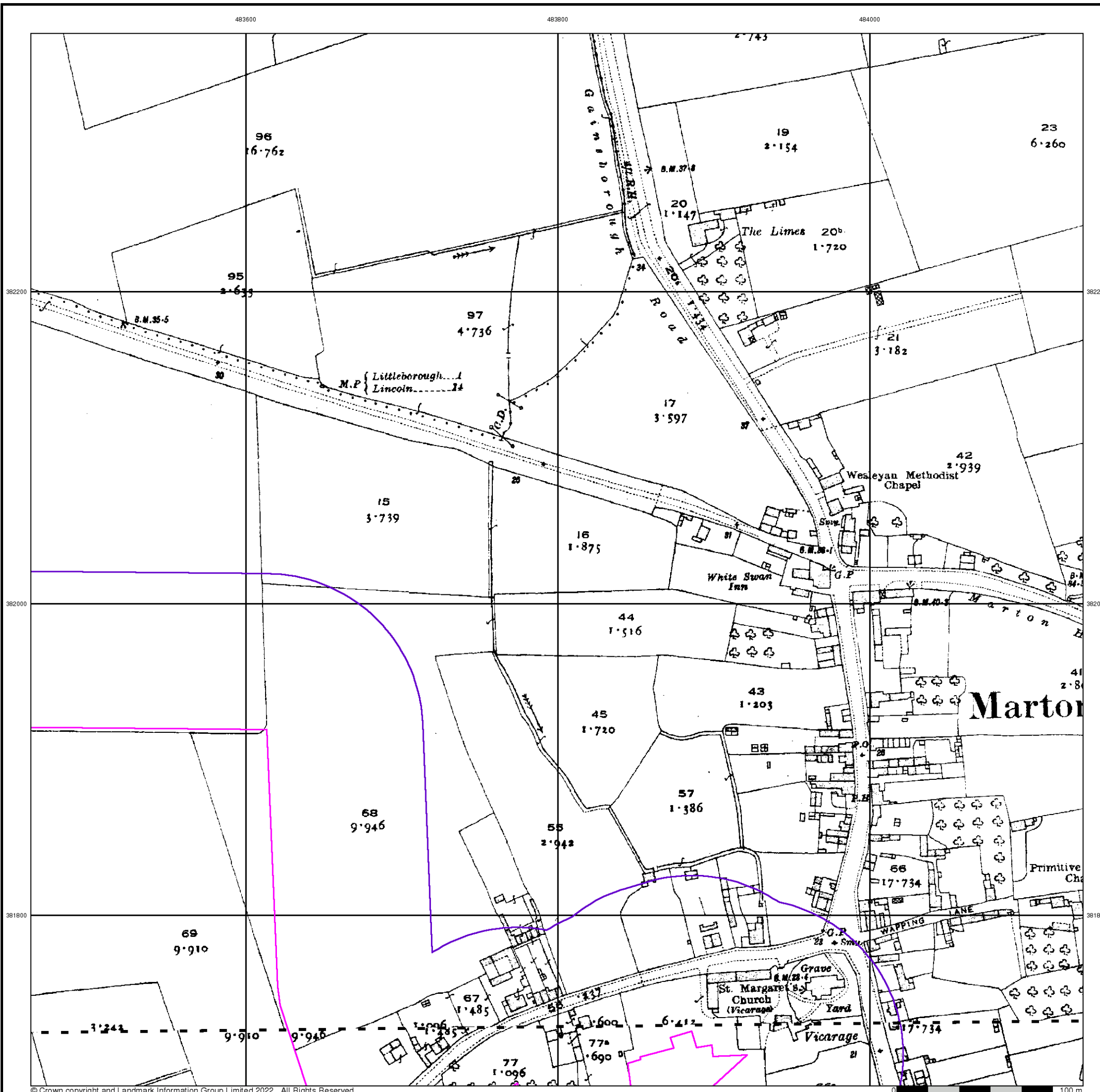

Ordnance Survey Plan
Published 1974 - 1975
Source map scale - 1:2,500

The historical maps shown were reproduced from maps predominantly held at the scale adopted for England, Wales and Scotland in the 1840's. In 1854 the 1:2,500 scale was adopted for mapping urban areas and by 1896 it covered the whole of what were considered to be the cultivated parts of Great Britain. The published date given below is often some years later than the surveyed date. Before 1938, all OS maps were based on the Cassini Projection, with independent surveys of a single county or group of counties, giving rise to significant inaccuracies in outlying areas.

Map Name(s) and Date(s)

SK8382 1975 1:2,500	SK8482 1975 1:2,500
SK8381 1975 1:2,500	SK8481 1974 1:2,500

Historical Map - Segment B16

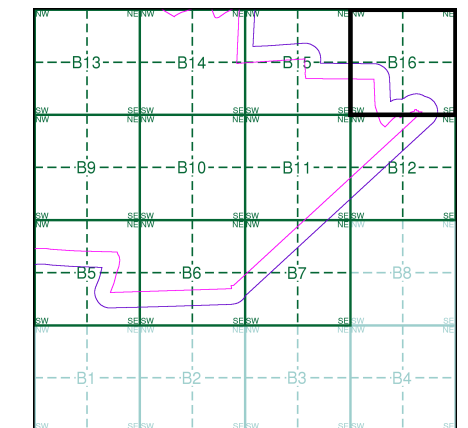

Order Details

Order Number: 298001706_1_1
 Customer Ref: 21-2098.04
 National Grid Reference: 482570, 381420
 Slice: B
 Site Area (Ha): 1355.61
 Search Buffer (m): 100

Site Details

West Barton 2

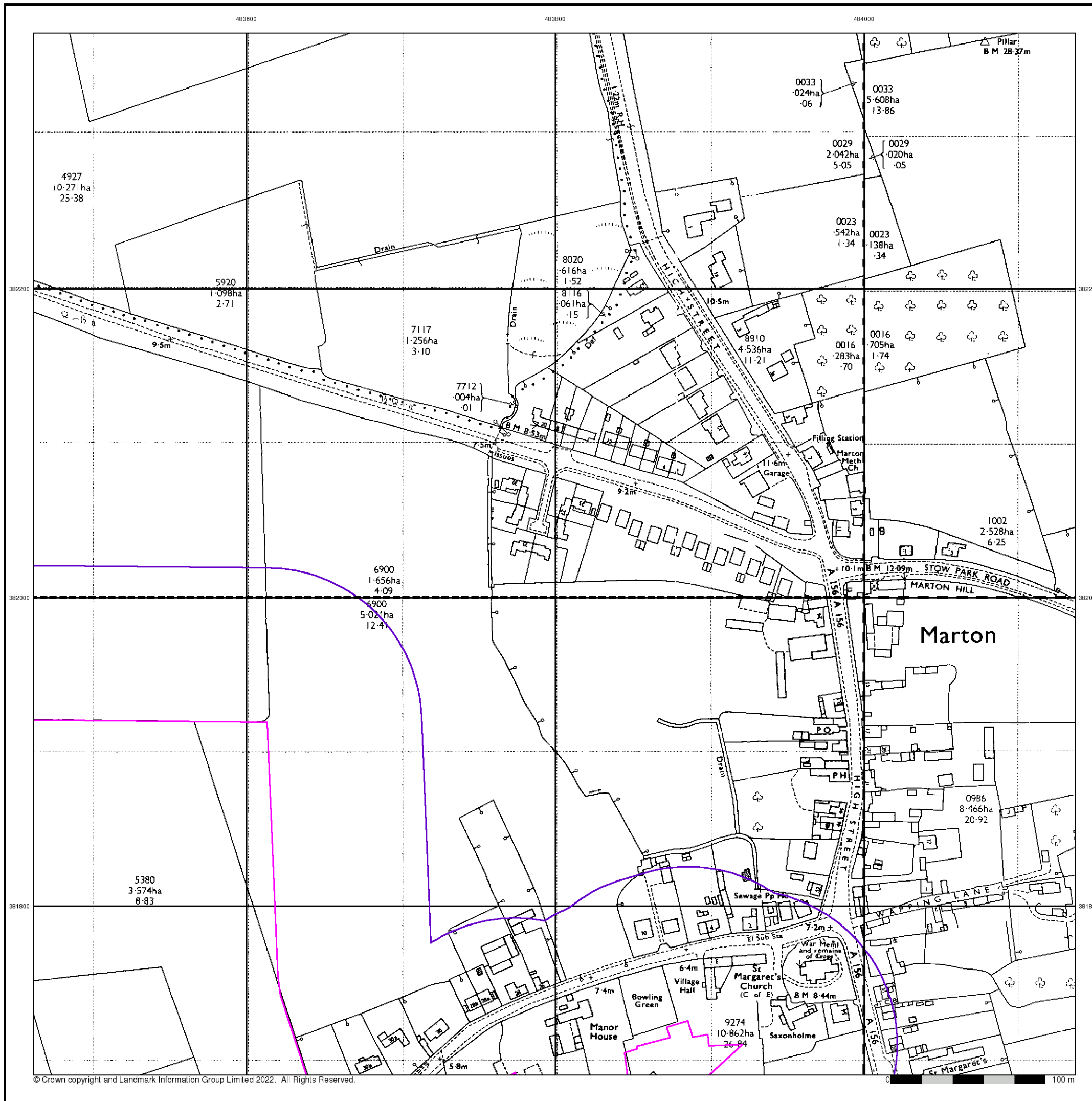

483600

483800

484000

382200

382200

382000

382000

381800

381800



Additional SIMs

Published 1993

Source map scale - 1:2,500

The SIM cards (Ordnance Survey's 'Survey of Information on Microfilm') are further, minor editions of mapping which were produced and published in between the main editions as an area was updated. They date from 1947 to 1994, and contain detailed information on buildings, roads and land-use. These maps were produced at both 1:2,500 and 1:1,250 scales.

Map Name(s) and Date(s)

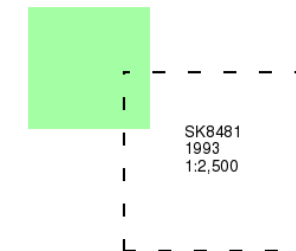

Historical Map - Segment B16

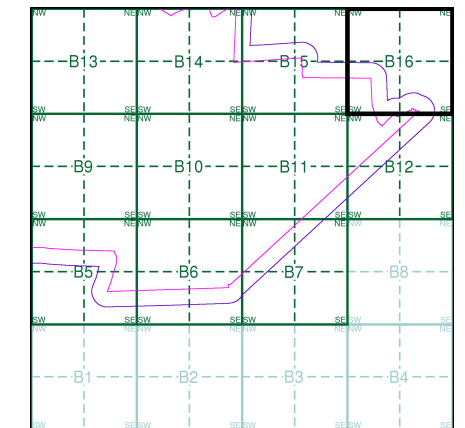

Order Details

Order Number:	298001706_1_1
Customer Ref:	21-2098.04
National Grid Reference:	482570, 381420
Slice:	B
Site Area (Ha):	1355.61
Search Buffer (m):	100

Site Details

West Barton 2



Tel:	0844 844 9952
Fax:	0844 844 9951
Web:	[REDACTED]

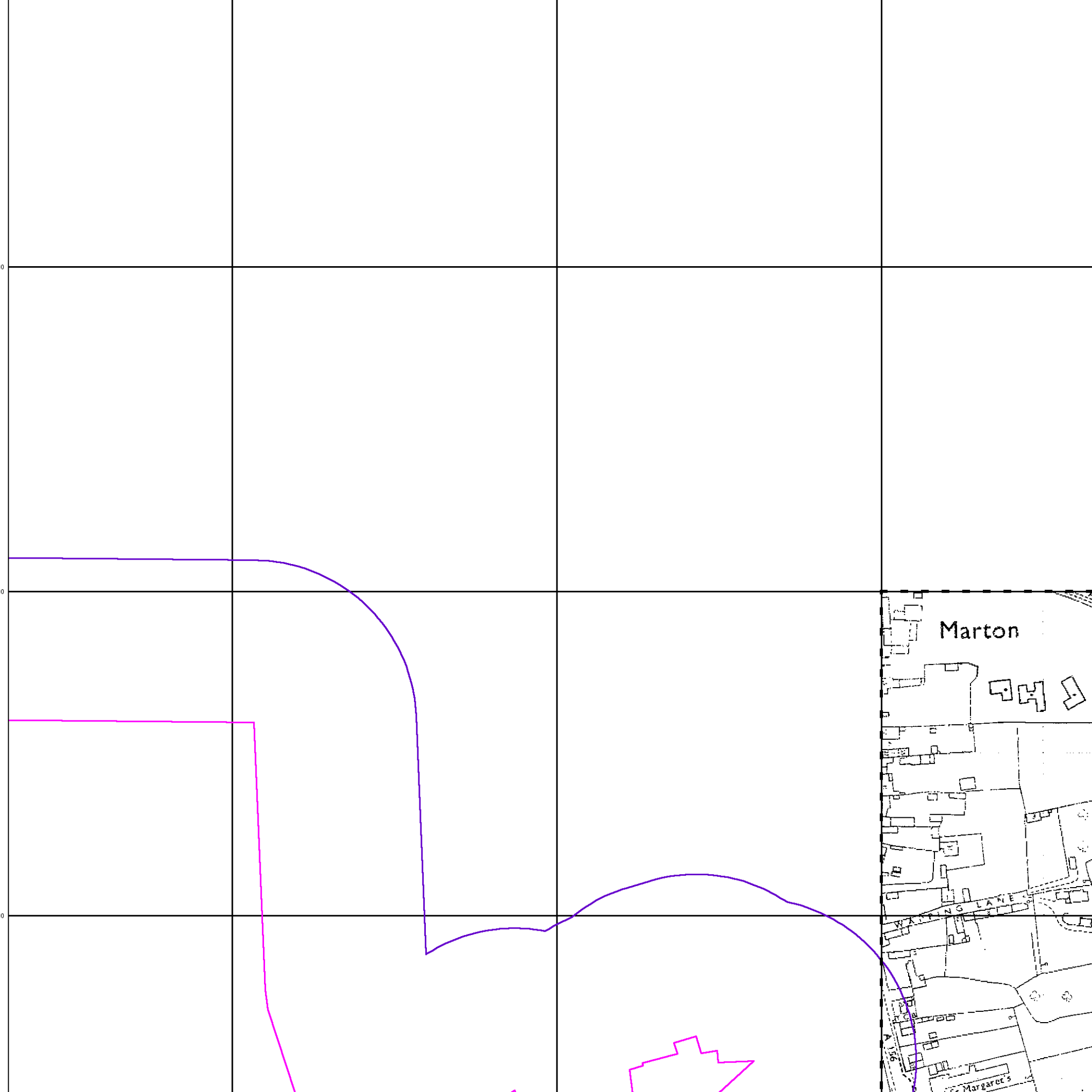

Large-Scale National Grid Data

Published 1994

Source map scale - 1:2,500

'Large Scale National Grid Data' superseded SIM cards (Ordnance Survey's 'Survey of Information on Microfilm') in 1992, and continued to be produced until 1999. These maps were the fore-runners of digital mapping and so provide detailed information on houses and roads, but tend to show less topographic features such as vegetation. These maps were produced at both 1:2,500 and 1:1,250 scales.

Map Name(s) and Date(s)

SK8382	SK8482
1994	1994
1:2,500	1:2,500
SK8381	SK8481
1994	1994
1:2,500	1:2,500

Historical Map - Segment B16

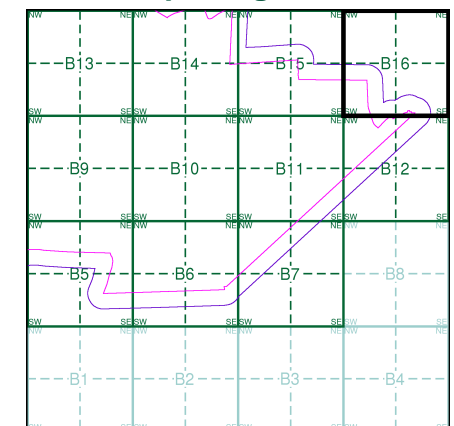

Order Details

Order Number: 298001706_1_1
 Customer Ref: 21-2098.04
 National Grid Reference: 482570, 381420
 Slice: B
 Site Area (Ha): 1355.61
 Search Buffer (m): 100

Site Details

West Barton 2



Historical Mapping Legends

Ordnance Survey County Series 1:10,560

- Gravel Pit
- Sand Pit
- Other Pits
- Quarry
- Shingle
- Orchard
- Osiers
- Reeds
- Marsh
- Mixed Wood
- Deciduous
- Brushwood
- Fir
- Furze
- Rough Pasture
- Arrow denotes flow of water
- Trigonometrical Station
- Site of Antiquities
- Bench Mark
- Pump, Guide Post, Signal Post
- Well, Spring, Boundary Post
- 285** Surface Level
- Sketched Contour
- Instrumental Contour
- Main Roads
- Minor Roads
- Sunken Road
- Raised Road
- Road over Railway
- Railway over River
- Railway over Road
- Level Crossing
- Road over River or Canal
- Road over Stream
- Road over Stream
- County Boundary (Geographical)
- County & Civil Parish Boundary
- Administrative County & Civil Parish Boundary
- County Borough Boundary (England)
- County Burgh Boundary (Scotland)
- Rural District Boundary
- Civil Parish Boundary

Ordnance Survey Plan 1:10,000

- Chalk Pit, Clay Pit or Quarry
- Gravel Pit
- Sand Pit
- Disused Pit or Quarry
- Refuse or Slag Heap
- Lake, Loch or Pond
- Dunes
- Boulders
- Coniferous Trees
- Non-Coniferous Trees
- Orchard
- Scrub
- Coppice
- Bracken
- Heath
- Rough Grassland
- Marsh
- Reeds
- Saltings
- Building
- Glasshouse
- Sloping Masonry
- Pylon
- Electricity Transmission Line
- Pole
- Cutting
- Embankment
- Standard Gauge Multiple Track
- Standard Gauge Single Track
- Siding, Tramway or Mineral Line
- Narrow Gauge
- Geographical County
- Administrative County, County Borough or County of City
- Municipal Borough, Urban or Rural District, Burgh or District Council
- Borough, Burgh or County Constituency
- Civil Parish
- BP, BS** Boundary Post or Stone
- Ch** Church
- CH** Club House
- F E Sta** Fire Engine Station
- FB** Foot Bridge
- Fn** Fountain
- GP** Guide Post
- MP** Mile Post
- MS** Mile Stone
- Pol Sta** Police Station
- PO** Post Office
- PC** Public Convenience
- PH** Public House
- SB** Signal Box
- Spr** Spring
- TCB** Telephone Call Box
- TCP** Telephone Call Post
- W** Well

1:10,000 Raster Mapping

- Gravel Pit
- Rock
- Boulders
- Shingle
- Sand
- Slopes
- General detail
- Overhead detail
- Multi-track railway
- County boundary (England only)
- District, Unitary, Metropolitan, London Borough boundary
- Refuse tip or slag heap
- Rock (scattered)
- Boulders (scattered)
- Mud
- Sand Pit
- Top of cliff
- Underground detail
- Narrow gauge railway
- Single track railway
- Civil, parish or community boundary
- Constituency boundary
- Area of wooded vegetation
- Non-coniferous trees
- Coniferous trees
- Positioned tree
- Coppice or Osiers
- Heath
- Marsh, Salt Marsh or Reeds
- Flow arrows
- Mean high water (springs)
- Mean low water (springs)
- Electricity transmission line (with poles)
- Telephone line (where shown)
- Bench mark (where shown)
- Point feature (e.g. Guide Post or Mile Stone)
- Site of (antiquity)
- General Building
- Important Building



Historical Mapping & Photography included:

Mapping Type	Scale	Date	Pg
Lincolnshire	1:10,560	1885	2
Nottinghamshire	1:10,560	1900	3
Lincolnshire	1:10,560	1906	4
Lincolnshire	1:10,560	1922	5
Lincolnshire	1:10,560	1922	6
Lincolnshire	1:10,560	1947	7
Ordnance Survey Plan	1:10,000	1956	8
Ordnance Survey Plan	1:10,000	1974 - 1979	9
Ordnance Survey Plan	1:10,000	1980 - 1981	10
10K Raster Mapping	1:10,000	2000	11
Street View	Variable		12

Historical Map - Slice C

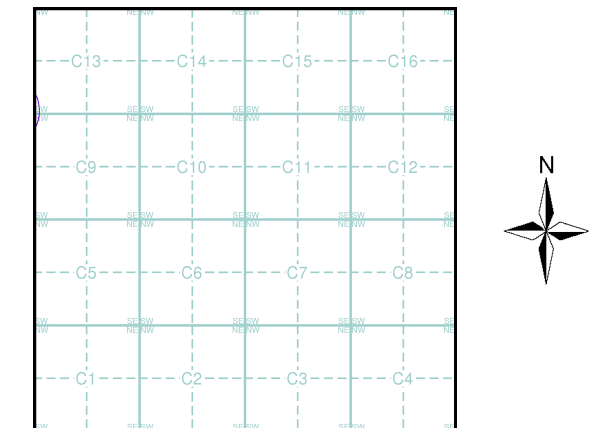

Order Details

Order Number: 298001706_1_1
 Customer Ref: 21-2098.04
 National Grid Reference: 484150, 381710
 Slice: C
 Site Area (Ha): 1355.61
 Search Buffer (m): 250

Site Details

West Barton 2



Tel: 0844 844 9952
 Fax: 0844 844 9951
 Web: [REDACTED]

Lincolnshire

Published 1885

Source map scale - 1:10,560

The historical maps shown were reproduced from maps predominantly held at the scale adopted for England, Wales and Scotland in the 1840's. In 1854 the 1:2,500 scale was adopted for mapping urban areas; these maps were used to update the 1:10,560 maps. The published date given therefore is often some years later than the surveyed date. Before 1938, all OS maps were based on the Cassini Projection, with independent surveys of a single county or group of counties, giving rise to significant inaccuracies in outlying areas. In the late 1940's, a Provisional Edition was produced, which updated the 1:10,560 mapping from a number of sources. The maps appear unfinished - with all military camps and other strategic sites removed. These maps were initially overprinted with the National Grid. In 1970, the first 1:10,000 maps were produced using the Transverse Mercator Projection. The revision process continued until recently, with new editions appearing every 10 years or so for urban areas.

Map Name(s) and Date(s)

051SW
1885
1:10,560
060NW
1885
1:10,560

Historical Map - Slice C

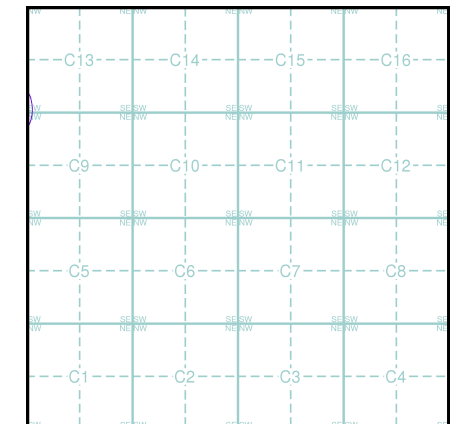

Order Details

Order Number: 298001706_1_1
 Customer Ref: 21-2098.04
 National Grid Reference: 484150, 381710
 Slice: C
 Site Area (Ha): 1355.61
 Search Buffer (m): 250

Site Details

West Barton 2

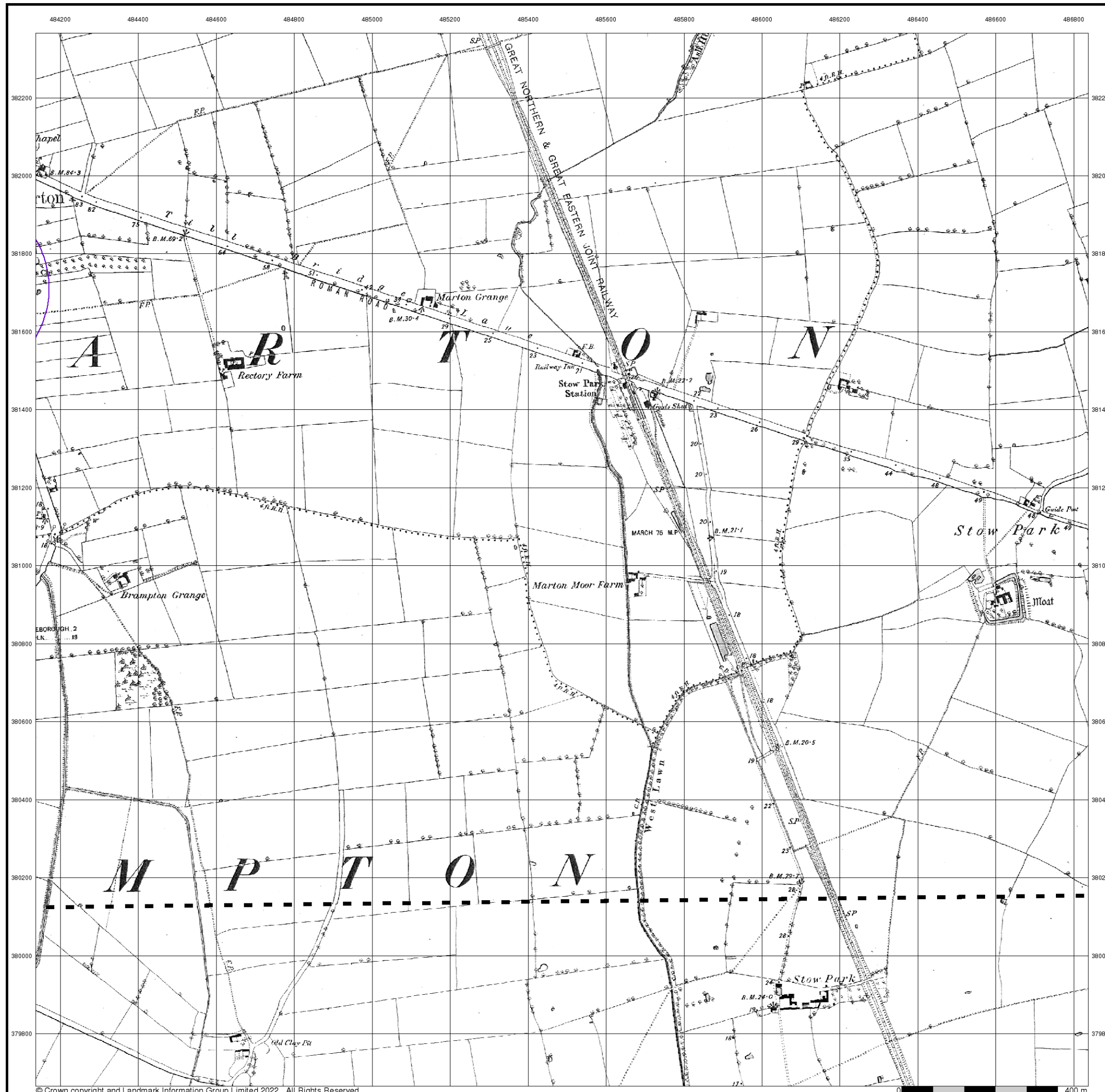

Nottinghamshire

Published 1900

Source map scale - 1:10,560

The historical maps shown were reproduced from maps predominantly held at the scale adopted for England, Wales and Scotland in the 1840's. In 1854 the 1:2,500 scale was adopted for mapping urban areas; these maps were used to update the 1:10,560 maps. The published date given therefore is often some years later than the surveyed date. Before 1938, all OS maps were based on the Cassini Projection, with independent surveys of a single county or group of counties, giving rise to significant inaccuracies in outlying areas. In the late 1940's, a Provisional Edition was produced, which updated the 1:10,560 mapping from a number of sources. The maps appear unfinished - with all military camps and other strategic sites removed. These maps were initially overprinted with the National Grid. In 1970, the first 1:10,000 maps were produced using the Transverse Mercator Projection. The revision process continued until recently, with new editions appearing every 10 years or so for urban areas.

Map Name(s) and Date(s)

011SW	1900	1:10,560
016NW	1900	1:10,560

Historical Map - Slice C

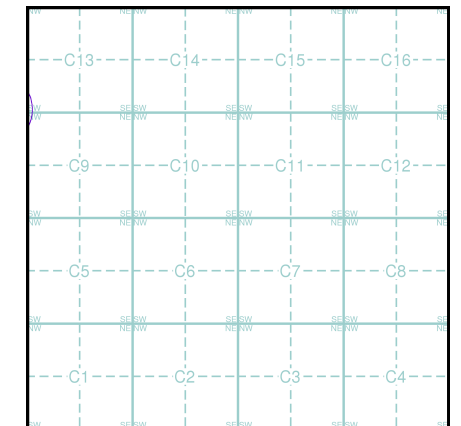

Order Details

Order Number: 298001706_1_1
 Customer Ref: 21-2098.04
 National Grid Reference: 484150, 381710
 Slice: C
 Site Area (Ha): 1355.61
 Search Buffer (m): 250

Site Details

West Barton 2

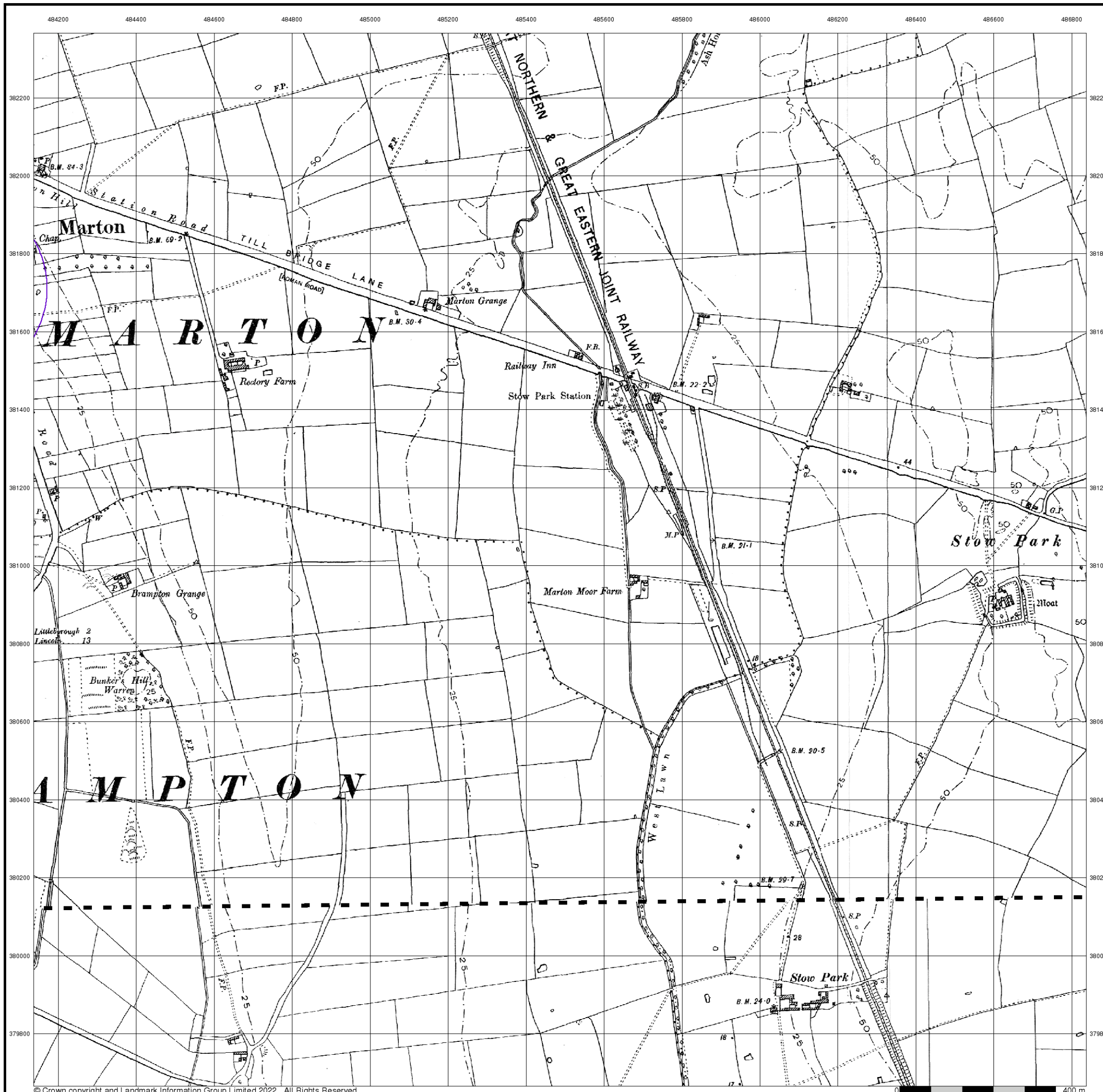

Lincolnshire

Published 1906

Source map scale - 1:10,560

The historical maps shown were reproduced from maps predominantly held at the scale adopted for England, Wales and Scotland in the 1840's. In 1854 the 1:2,500 scale was adopted for mapping urban areas; these maps were used to update the 1:10,560 maps. The published date given therefore is often some years later than the surveyed date. Before 1938, all OS maps were based on the Cassini Projection, with independent surveys of a single county or group of counties, giving rise to significant inaccuracies in outlying areas. In the late 1940's, a Provisional Edition was produced, which updated the 1:10,560 mapping from a number of sources. The maps appear unfinished - with all military camps and other strategic sites removed. These maps were initially overprinted with the National Grid. In 1970, the first 1:10,000 maps were produced using the Transverse Mercator Projection. The revision process continued until recently, with new editions appearing every 10 years or so for urban areas.

Map Name(s) and Date(s)

051SW	1906	1:10,560
060NW	1906	1:10,560

Historical Map - Slice C

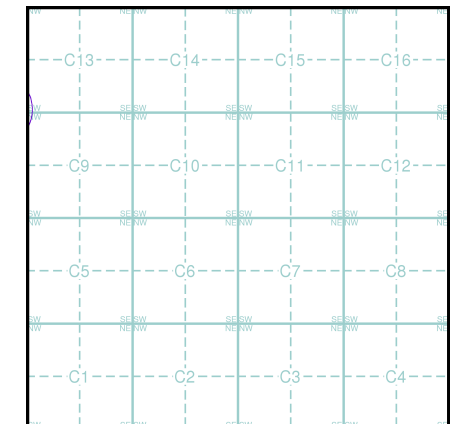

Order Details

Order Number: 298001706_1_1
 Customer Ref: 21-2098.04
 National Grid Reference: 484150, 381710
 Slice: C
 Site Area (Ha): 1355.61
 Search Buffer (m): 250

Site Details

West Barton 2

